

TRAVIS

REPAIR PARTS

STEEL VALVE STEMS $\frac{5}{8}$ ACME

Part #	Description
Stem 6 3/4	5/8 x 6 3/4 zinc
Stem 6 3/4 brs	5/8 x 6 3/4 brass
Stem 6 3/4 ss	5/8 x 6 3/4 stainless steel
Stem 9	5/8 x 9 zinc
Stem 9 brs	5/8 x 9 brass
Stem 9 ss	5/8 x 9 stainless steel
Stem 11	1 x 11 zinc

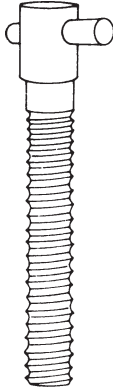

Universal - For 3" x 4"
 Universal Valves, Fit most Pierce,
 Alumax, Irreco, Moore Rane
 Wade - Universal, Ames, Lake,
 Crown, Western and Travis-
 Rainway.

Note: Use 9" stems to replace those 7.5" and longer. 11" stems are 1" in diameter and are for 8" valves.

Misc. Stems:

- Stem 6 3/4 8 Pitch Stainless Steel
- Redi Rain Hex
- Stem-Stainless
- VTC Stem 1/2"
- RVTC Stem 3/4" Brass

VALVE DISC

Domed Styles:



- *Domed Disc 3" 5/8" hole
- *Domed Disc 4" 5/8" hole
- *Domed Disc 5" 5/8" hole
- *Domed Disc 6" 5/8" hole
- *Domed Disc 8" 1" hole

*Fits most Pierce, Alumax, Irreco, Moore Rane Wade Universal, Ames, Lake, Crown, Western and Travis-Rainway Valves with 5/8" stem hole.

Flat Styles:



- Flat Disc 3" 1/2" hole
- *Fits Most 5/8" hole
- Universal Valves 3/4" hole
- Flat Disc 4" 1/2" hole
- *Fits Most 5/8" hole
- Universal Valves 3/4" hole
- 4" Sure Rane
- Flat Disc 5" 5/8" hole
- 3/4" hole
- Flat Disc 6" 5/8" hole
- 3/4" hole

Product of: **TRAVIS PATTERN & FOUNDRY INC., SPOKANE, WASHINGTON**

Prices: SUBJECT TO CHANGE WITHOUT NOTICE

FAX: (509) 467-6465 - PHONE: (509) 466-3545

Prices effective: August 2008

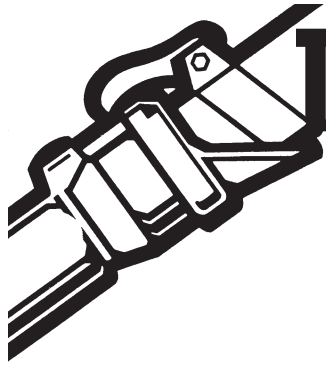

TRAVIS

REPAIR PARTS

WELD IN STEEL SPIDER — UNIVERSAL

<i>SIZE</i>	<i>DESIGNATION PERMANENT</i>
4"	WSS-4
5"	WSS-5

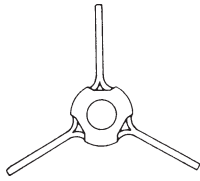

<i>SIZE</i>	<i>PERMANENT HEAVY DUTY</i>
3"	WSS3HD
4"	WSS4HD
5"	WSS5HD
6"	WSS6HD
8"	WSS8HD

<i>SIZE</i>	<i>REPLACEABLE</i>
4"	WSS4RP

REPLACEABLE VALVE BRASS NUT & SNAP RING

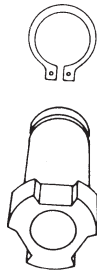

3" x 4" valves

5" x 6" valves

Stainless Steel
Snap Ring

Replacement
Brass Nut

Product of: **TRAVIS PATTERN & FOUNDRY INC., SPOKANE, WASHINGTON**

Prices: SUBJECT TO CHANGE WITHOUT NOTICE

FAX: (509) 467-6465 - PHONE: (509) 466-3545

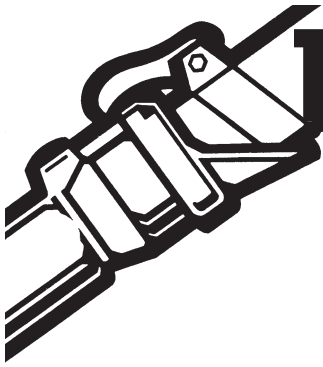

TRAVIS

REPAIR PARTS

VALVE OPENER PARTS

Universal - Fits Travis/Rainway
and most other Universal Openers.

UVEO — RING LOCK ELBOWS ALUMINUM OPENERS RAINWAY

ITEM #	SIZE	
	3"	4"

- (A) UVEO Stem $\frac{5}{8}$ ", 9 $\frac{1}{4}$ " Length
- (B) UVEO T Crank $\frac{5}{8}$ " Aluminum
UVEO T Crank $\frac{5}{8}$ " Steel
- (C) UVEO Yoke
- (D) UVEO Gland Nut
UVEO Packing
- (F) UVEO Ring Lock Clamp
- (G) UVEO Roll Pin 1 $\frac{1}{4}$ "

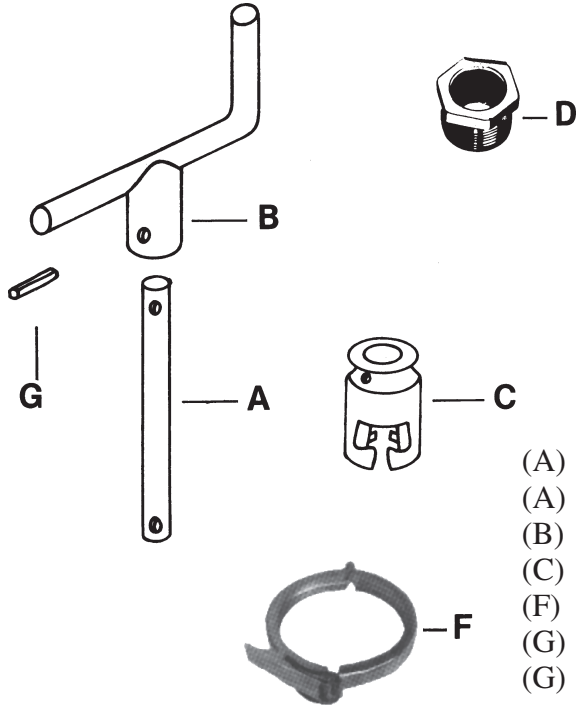

STEEL OPENERS WESTERN & PIERCE TYPE

ITEM #	SIZE				
	3"	4"	5"	6"	8"

- (A) SUVEO Stem $\frac{3}{4}$ " 9 $\frac{1}{4}$ " Length
- (A) SUVEO Stem $\frac{3}{4}$ " 12" Length
- (B) SUVEO T Crank $\frac{3}{4}$ " Steel
- (C) SUVEO Yoke
- (F) SUVEO Ring Lock Clamp
- (G) SUVEO Roll Pin 1"
- (G) SUVEO Roll Pin 1 $\frac{1}{4}$ "
Chevron $\frac{3}{4}$ "

1 pc. $\frac{3}{4}$ " Shaft 9" Long Socket Assy.
1 pc. $\frac{3}{4}$ " Shaft 15" Long Socket Assy.

(C) Fits both $\frac{5}{8}$ " & $\frac{3}{4}$ " stems.

See A&M Moore Rane Sections for parts
breakdown on A&M and Moore Rane Valve Openers.

IMPORTANT NOTICE:

Stems, Discs, Valve Opener Parts
Flapper and Mushroom Drains, Clamps, Bands, etc.
are interchangeable with most brands.
Contact us for assistance in replacement parts.

Many other manufacturer's gaskets available. Call factory.

Product of: **TRAVIS PATTERN & FOUNDRY INC., SPOKANE, WASHINGTON**

Prices: SUBJECT TO CHANGE WITHOUT NOTICE

FAX: (509) 467-6465 - PHONE: (509) 466-3545

Prices effective: August 2008

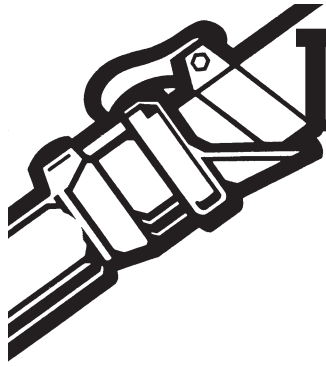

TRAVIS

REPAIR PARTS

RAINWAY GASKETS SQUARE BACK

FOR FULL BOX QUANTITIES ADD "FB" TO END OF PART NUMBER
example-E 1 3" FB

SIZE	DRAIN	NON DRAIN	APPOX. FULL BOX QUANTITY
2"	E-2 2"	—	1000
3"	E-2 3"	E-1 3"	500
4"	E-2 4"	E-1 4"	400
5"		E-1 5"	300
6"		E-1 6"	250
7"		E-1 7"	225
8"		E-1 8"	200
10"		E-1 10"	125
12"		E-1 12"	75
Old Style Rainway Round Back			
2"	E-1 E-2	E-3 2RW"	500
3"		E-3 3RW"	500

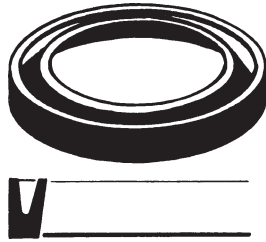

E-1 E-2

ROUND BACK GASKETS

Gaskets for Rainway Steel Couplers
(interchangeable with Pierce)

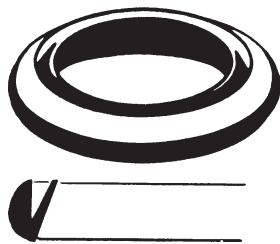

E-3

SIZE	DESIGNATION	APPROX. FULL BOX QTY.
2"	E-3 2"	900
3"	E-3 3"	500
4"	E-3 4"	250
5"	E-3 5"	200
6"	E-3 6"	150
7"	E-3 7"	150
8"	E-3 8"	100
10"	E-3 10"	100
12"	E-3 12"	75

Product of: **TRAVIS PATTERN & FOUNDRY INC., SPOKANE, WASHINGTON**

Prices: SUBJECT TO CHANGE WITHOUT NOTICE

FAX: (509) 467-6465 - PHONE: (509) 466-3545

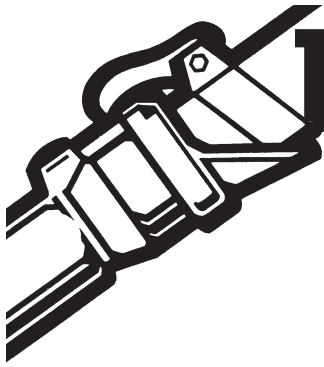

TRAVIS

REPAIR PARTS

A&M GASKETS

FOR FULL BOX QUANTITIES ADD "FB" TO END OF PART NUMBER

example-G 32 FB

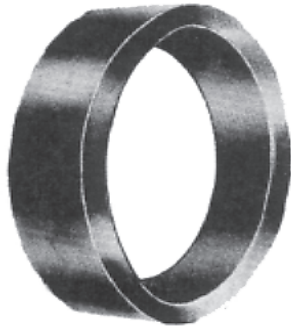

Gasket numbers are stamped on the inside lip of each gasket.

* 4 1/2" special V.O. Gasket G 452.

DRAIN APPROX. FULL

SIZE	DESIGNATION	BOX QTY.
2"	G 22	1000
3"	G 32	500
4"	G 42	300
5"	G 52	250
6"	G 62	200
8"	G 82	150

NON DRAIN

2"	G 23	1000
3"	G 33	500
4"	G 43	300
*4 1/2"	G 452	250
5"	G 53	250
6"	G 63	200
7"	G 73	175
8"	G 83	150
10"	G 103	100

HIGH PRESSURE OR SOLID SET

3"	3G 5	300
4"	4G 5	300
5"	5G 5	250
6"	6G 5	250
8"	8G 5	175
10"	10G 5	150

Product of: **TRAVIS PATTERN & FOUNDRY INC., SPOKANE, WASHINGTON**

Prices: SUBJECT TO CHANGE WITHOUT NOTICE

FAX: (509) 467-6465 - PHONE: (509) 466-3545

Prices effective: August 2008



TRAVIS

REPAIR PARTS

MOORE RANE GASKETS

FOR FULL BOX QUANTITIES ADD "FB" TO END OF PART NUMBER

example-3NDG FB

**NON DRAIN
WIDE STYLE**



APPROX. FULL

<i>SIZE</i>	<i>DESIGNATION</i>	<i>BOX QTY.</i>
2"	2NDG	700
3"	3NDG	400
4"	4NDG	200
5"	5NDG	150
6"	6NDG	100
7"	7NDG	100
8"	8NDG	100
10"	10NDG	75

**SOLID-LOCK
NARROW STYLE**



2"	2SLDG	700
2"	2SLNDG	700
3"	3SLDG	400
3"	3SLNDG	400

WESTERN SQUARE BACK GASKETS

FOR FULL BOX QUANTITIES ADD "FB" TO END OF PART NUMBER

example-G 28 FB

NON DRAIN



APPROX. FULL

<i>SIZE</i>	<i>DESIGNATION</i>	<i>BOX QTY.</i>
2"	G 28	700
3"	G 38	400
4"	G 48	250
5"	G 58	200
6"	G 68	150
7"	G 78	125
8"	G 88	100
10"	G 108	100
12"	G 128	75

DRAIN

3"	G 39	400
4"	G 49	250

Product of: **TRAVIS PATTERN & FOUNDRY INC., SPOKANE, WASHINGTON**

Prices: SUBJECT TO CHANGE WITHOUT NOTICE

FAX: (509) 467-6465 - PHONE: (509) 466-3545

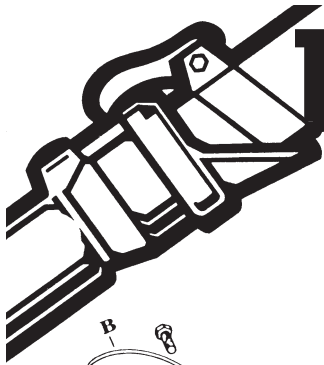

TRAVIS

REPAIR PARTS



FULL BAND AND LATCH (Including, Nut, Bolt and Ferrule)

SIZE	DESIGNATION
2"	
3"	
4"	See Rainway, A&M, Western & Round Back Sections
5"	
6"	
7"	
8"	
10"	

(A) FULL BAND ONLY

SIZE	DESIGNATION
2"	B200
3"	B300
4"	B400
5"	B500
6"	B600
7"	B700
8"	B800
10"	B1000

LOOSE FIT BAND ONLY

SIZE	DESIGNATION
2"	B200 OS
3"	B300 OS
4"	B400 OS
5"	B500 OS
6"	B600 OS

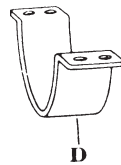

(B) OUTSIDE LATCH

Rainway
201007 Reg. A & M
201012 Long. A & M
And Moore Rane
Western
Pierce Type

(C) LATCH FERRULE

⁵/₁₆"
1/2"
Rainway
Latch Spring
201154 A & M
Latch Spring

(D) COUPLER AND VALVE HALF BANDS

SIZE
3" Half Band
4" Half Band
5" Half Band

SIZE
6"

HIGH PRESSURE RING LOCK CLAMP



Heavy duty steel ringlock clamp.

* OVERSIZED
TO FIT GATED
PIPE BELL COUPLERS

FITS STEEL ONLY

FITS STEEL ONLY

SIZE	DESIGNATION	WT.
3"	HPRLC 300	1.50 lbs
4"	HPRLC 400	1.60
5"	HPRLC 500	1.80
6"	HPRLC 600	2.00
*6"	HPRLC 600 TL	2.00
7"	HPRLC 700	2.25
8"	HPRLC 800	2.50
*8"	HPRLC 800 TL	2.50
10"	HPRLC 1000	3.25
10"	HPRLC 1000S	3.50
12"	HPRLC 1200	5.25
12"	HPRLC 1200S	5.25

HOLD BANDS



STEEL ITEM #	ALUM. ITEM #	WEIGHT PER 100 ALUM.	WEIGHT PER 100 STEEL	SIZE
	HB-300	—	—	3"
SHB4	HB-400	13.00 lbs	30.00 lbs	4"
SHB5	HB-500	16.00	38.00	5"
	HB-600	19.00	50.00	6"
	HB-800	44.00	75.00	8"
SHB10	HB-1000	63.00	88.00	10"
SHB12	HB-1200	—	100.00	12"

Product of: **TRAVIS PATTERN & FOUNDRY INC., SPOKANE, WASHINGTON**

Prices: SUBJECT TO CHANGE WITHOUT NOTICE

FAX: (509) 467-6465 - PHONE: (509) 466-3545

Prices effective: August 2008



TRAVIS

REPAIR PARTS

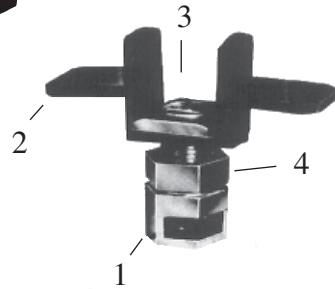

ITEM #

FD-100 complete

- 1 Splash Nut
- 2 Rubber Flapper
- 3 Insert
- 4 Jam Nut

MUSHROOM DRAIN



<i>DESIGNATION</i>	<i>ITEM #</i>	<i>SIZE</i>
Drain	D-2-5	Long
Clip	D-2-4 SC	

TORQUE COUPLER 'O' RING

<i>PART NO.</i>	<i>FITS</i>	<i>PART NO.</i>	<i>FITS</i>
Org	Travis/Western Aluminum	200424	Trunnell 4" Steel
WID E-1	Travis Internal Drain	200425	Trunnell 5" Steel
200463	A&M Round	200426	Trunnell/Crown Aluminum
200470	A&M Square	300464	Western Steel

PRESSING COMPOUND



Used in aluminum tube fabrication.

	<i>ITEM #</i>	<i>SIZE</i>
Forrest	WNA-1F	'A' w/catalyst
	Part A	
	Part B	
	Epoxy thinner	1 gal.



3M CEMENT

<i>ITEM #</i>	<i>WT.</i>
A-88	5 oz

Used to glue in center bolt-on riser outlet gaskets and torque coupler 'O' rings. Larger quantities available upon request.

Product of: **TRAVIS PATTERN & FOUNDRY INC., SPOKANE, WASHINGTON**

Prices: SUBJECT TO CHANGE WITHOUT NOTICE

FAX: (509) 467-6465 - PHONE: (509) 466-3545

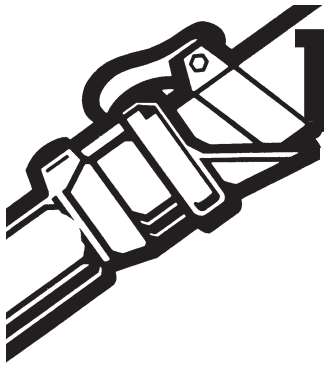

TRAVIS

REPAIR PARTS



PIVOT ACCESSORIES

J DROP

<i>PART No.</i>	<i>LIST DESCRIPTION</i>	<i>WT.</i>
IPS J 642	6" Dia. 42" Height	27.00 lbs
IPS J 842	8" Dia. 42" Height	48.00
IPS J 1042	10" Dia. 42" Height	59.00
PIP J 642	6" Dia. 42" Height	27.00 lbs
PIP J 842	8" Dia. 42" Height	48.00
PIP J 1042	10" Dia. 42" Height	59.00

Standard is ring lock end at top, PVC female end at the bottom, 42" height. Other ends and heights available. Also available with air relief and pressure relief elbows as shown on page 2 in Epoxy Underground Section. Contact Factory.

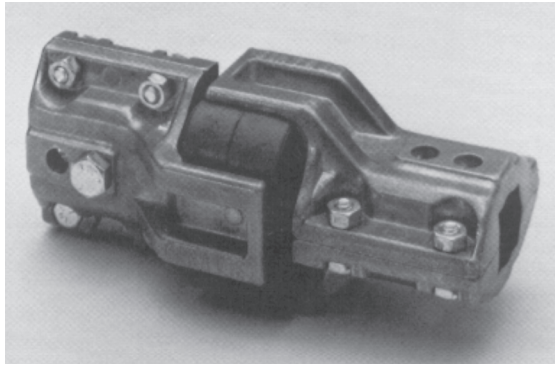

U-JOINT DRIVELINE COUPLER ASSEMBLIES*

*Includes 4 arm 1/2s, rubber puck insert and nut & bolt package

SETS

<i>PART No.</i>	<i>DESCRIPTION</i>	<i>WT.</i>
DCA 1 x 1s	1" Round to 1" Square Shaft	2.50 lbs
DCA 1 x 7/8s	1" Round to 7/8" Square Shaft	2.50
DCA 1 x 3/4s	1" Round to 3/4" Square Shaft	2.50
DCA 1 kw x 3/4s	1" Round w/Keyway to 3/4" Square Shaft	2.50

INDIVIDUAL PARTS

DCA-1	Arm 1/2 for 1" Round or 7/8" Square Shaft.	.40
DCA-1kw	Arm 1/2 for 1" Round w/Keyway	.40
DCA-1s	Arm 1/2 for 1" Square Shaft	.40
DCA- 3/4s	Arm 1/2 for 3/4" Square Shaft	.40
(DCA- 7/8s - Same as DCA-1)		
DCA-RP	Rubber Puck Insert	.50
DCA-NB	Nut & Bolt Package	.10

Product of: **TRAVIS PATTERN & FOUNDRY INC., SPOKANE, WASHINGTON**

Prices: SUBJECT TO CHANGE WITHOUT NOTICE

FAX: (509) 467-6465 - PHONE: (509) 466-3545

Prices effective: August 2008



TRAVIS

REPAIR PARTS

PIVOT ACCESSORIES

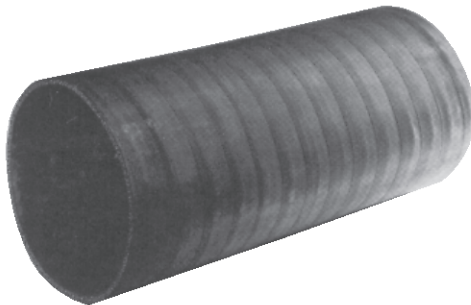

PIVOT BOOT

<i>PART No.</i>	<i>DESCRIPTION</i>	<i>WT.</i>
PB-16	6 ⁵ / ₈ x 16" Boot-Heavy Duty Nitrile Rubber w/Polyester Braid	3.50 lbs
PBC	Clamp for above-Stainless Steel	.50

BOLT ON ADJUSTABLE MALE END



<i>SIZE</i>	<i>DESIGNATION</i>	<i>WT.</i>
6"	SRLMBO 600	2.70 lbs
8"	SRLMBO 800	4.60
10"	SRLMBO 1000	5.80

Product of: **TRAVIS PATTERN & FOUNDRY INC., SPOKANE, WASHINGTON**

Prices: SUBJECT TO CHANGE WITHOUT NOTICE

FAX: (509) 467-6465 - PHONE: (509) 466-3545



TRAVIS

REPAIR PARTS

9-30 Diaphragm Pump Parts

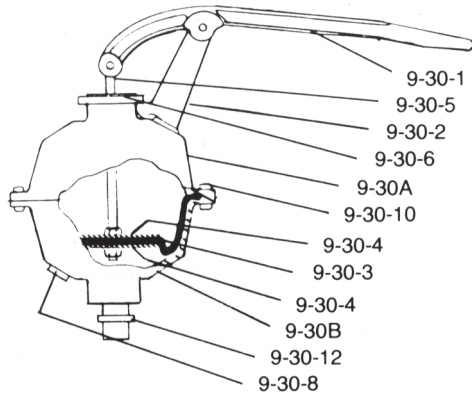

Part Number	Description	Required	Weight
9-30A	Body, top half	1	2.0 lbs.
9-30B	Body, lower half	1	2.0 lbs.
9-30-1	Handle	1	1.0 lbs.
9-30-2	Handle Support	1	0.5 lbs.
9-30-3	Rubber Diaphragm	1	0.4 lbs.
9-30-4	Steel Diaphragm	2	0.6 lbs.
9-30-5	Connecting Rod & Nut	1	0.3 lbs.
9-30-6	Handle Bracket Lock Nut	1	0.4 lbs.
9-30-8	Rubber Discharge Valve	1	0.1 lbs.
9-30-12	Ball Check Valve w/Ball	1	0.2 lbs.
9-30-133/4"	Stainless Ball only	1	0.1 lbs.

5000 Series Big Gun Cart

Part Number	Description
13-4B	Clamp Bottom
6069-3	Center Tube (axle)
6074-7	Center Journal
6100	Main Tube, 4" inlet
6103	Main Tube, 3" inlet
6101	Brace
70-4	Tail Wheel Clamp (6 required)
8-4URNB	Ring Set 4"
8-3RNB	Ring Set 3"
8-10DX	Positive Latch (Knob Style)
8-10G	Hook Style Latch

Product of: **TRAVIS PATTERN & FOUNDRY INC., SPOKANE, WASHINGTON**

Prices: SUBJECT TO CHANGE WITHOUT NOTICE

FAX: (509) 467-6465 - PHONE: (509) 466-3545

Prices effective: August 2008



Stands for Giant Sprinklers

17 Series Tripod Sprinkler Stands

Part Number	Description	Weight
15-5-4	Knob	0.5 lbs.
15-3-6 A&B	Pipe Clamp w/Bolt for 3" & 4" tubing	1.5 lbs.
15-5-6 A&B	Pipe Clamp w/Bolt for 5" & 6" tubing	1.6 lbs.
15-5-10	Set of 5 Nuts & Bolts for each Tripod	0.2 lbs.
16-5-0	Bolt Pack, includes 15-5-4 knob	
6057-4	Base Shoe	
6057-6	Riser Assembly for 17-3 (3" inlet)	
6057-20	Riser Assembly for 17-4 (4" inlet)	
6057-7	Upper Leg	
6057-8	Leg Brace	
6057-9	Lower Leg	
6081	Half Clamp	

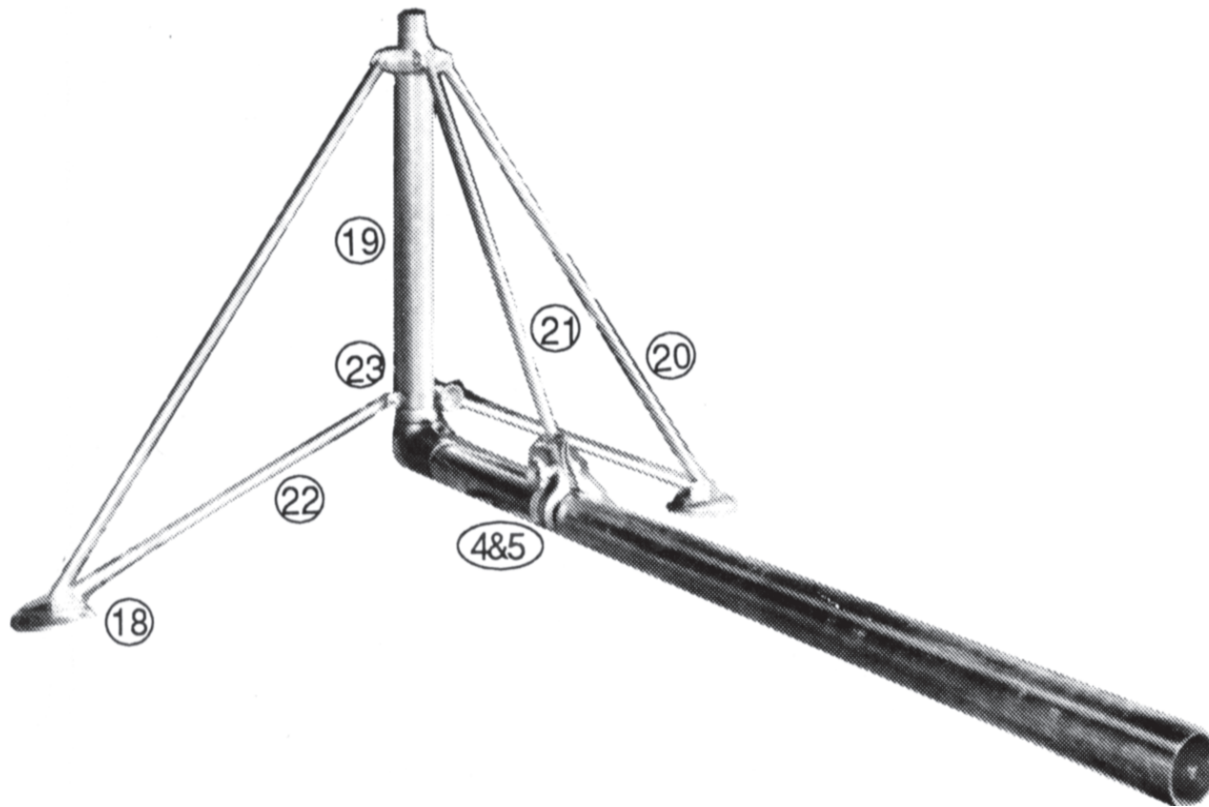

Product of: **TRAVIS PATTERN & FOUNDRY INC., SPOKANE, WASHINGTON**

Prices: SUBJECT TO CHANGE WITHOUT NOTICE

FAX: (509) 467-6465 - PHONE: (509) 466-3545

Prices effective: August 2008

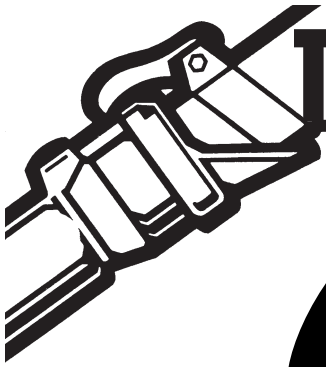

TRAVIS

REPAIR PARTS

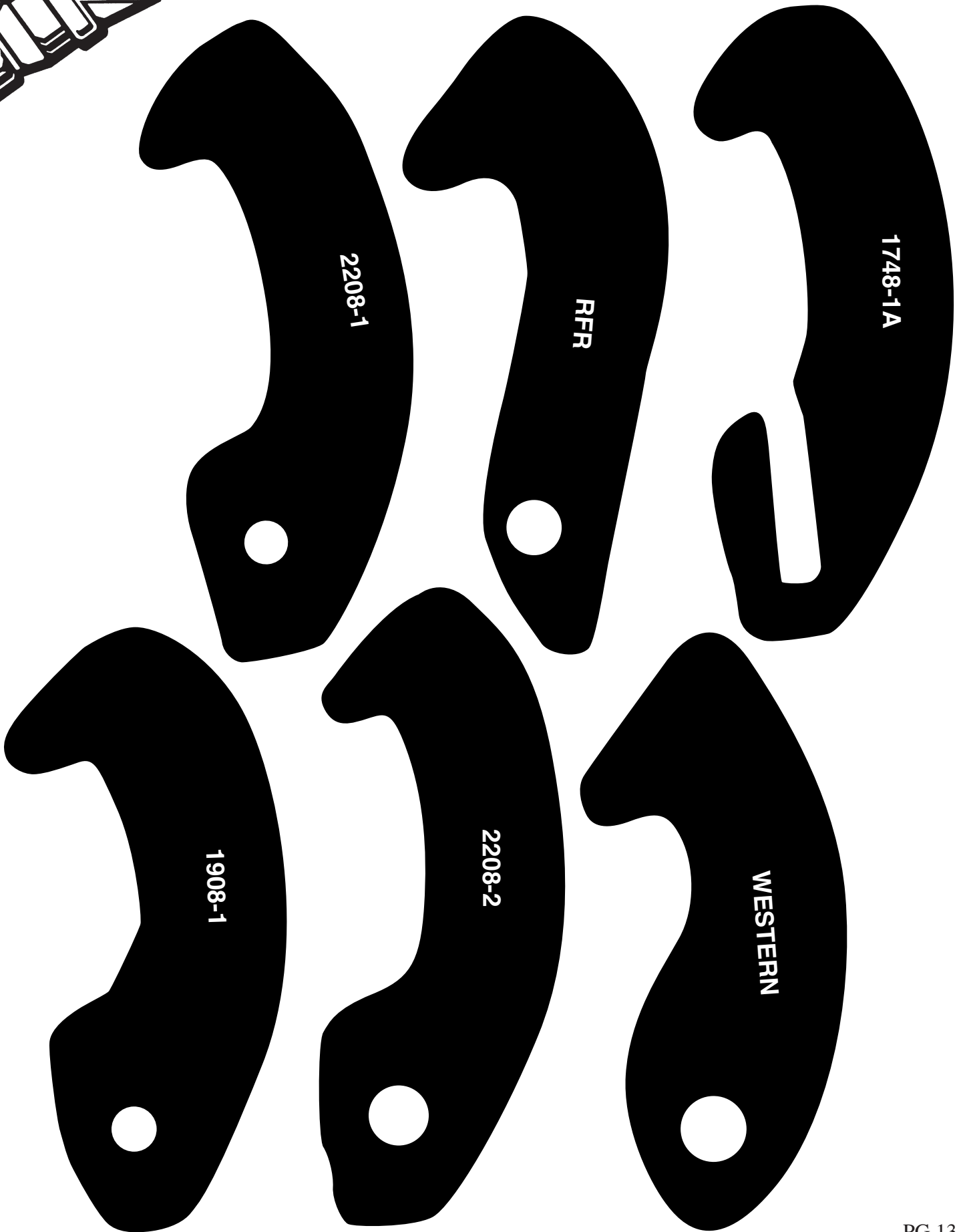

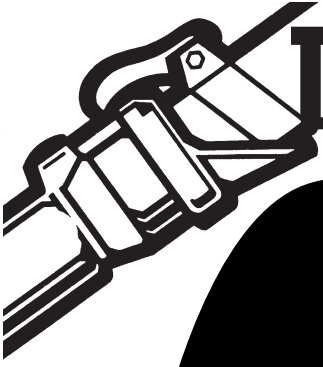

TRAVIS

REPAIR PARTS

