

VALVE STEMS 5/8" ACME THREAD

Part #	Description
Stem 6 3/4	5/8 x 6 3/4 zinc
Stem 6 3/4 brs	5/8 x 6 3/4 brass
Stem 6 3/4 ss	5/8 x 6 3/4 stainless steel.....
Stem 9	5/8 x 9 zinc
Stem 9 brs	5/8 x 9 brass.....
Stem 9 ss	5/8 x 9 stainless steel.....
Stem 11	1 x 11 zinc.....

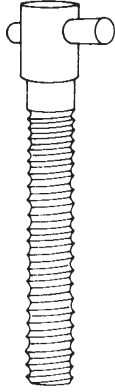

Universal - For 3" x 4"
 Universal Valves, Fit most Pierce,
 Alumax, Irreco, Moore Rane Wade
 - Universal, Ames, Lake, Crown,
 Western and Travis-Rainway.

Quantity discounts available.

Note: Use 9" stems to replace those 7.5" and longer. 11" stems are 1" in diameter and are for 8" valves.

Stem 6 3/4 box quantity of 90

Misc. Stems:

Stem 6 3/4 8 Pitch Stainless Steel	2236-2.....
Redi Rain Hex: Stem-Stainless	
VTC Stem 1/2"	
RVTC Stem 3/4" Brass.....	

VALVE DISC

Domed Styles:

*Domed Disc 3"	5/8" hole
*Domed Disc 4"	5/8" hole.....
*Domed Disc 5"	5/8" hole.....
*Domed Disc 6"	5/8" hole.....
*Domed Disc 8"	1" hole.....

*Fits most Pierce, Alumax, Irreco, Moore Rane Wade Universal, Ames, Lake, Crown, Western and Travis-Rainway Valves with 5/8" stem hole.

Flat Styles:

Disc Flat 3	1/2" hole
3A	5/8" hole
3B	3/4" hole
Disc Flat 4	1/2" hole
4A	5/8" hole
4B	3/4" hole
Disc Flat 5	5/8" hole
5A	3/4" hole
Disc Flat 6	5/8" hole
6A	3/4" hole
Sure Rain 4"



Domed Disc 4"
 Box quantity of 50



Product of: **TRAVIS PATTERN & FOUNDRY INC., SPOKANE, WASHINGTON**

Prices: SUBJECT TO CHANGE WITHOUT NOTICE

FAX: (509) 467-6465 - PHONE: (509) 466-3545

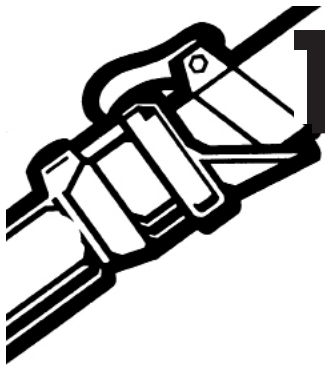

TRAVIS

UNIVERSAL PARTS

WELD IN STEEL SPIDER — UNIVERSAL

<i>SIZE</i>	<i>DESIGNATION PERMANENT</i>
4"	WSS-4
5"	WSS-5

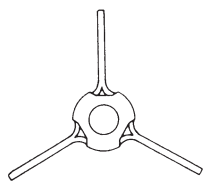

<i>SIZE</i>	<i>PERMANENT HEAVY DUTY</i>
3"	WSS3HD
4"	WSS4HD
5"	WSS5HD
6"	WSS6HD
8"	WSS8HD

<i>SIZE</i>	<i>REPLACEABLE</i>
4"	WSS4RP

Includes spider, brass nut and snap ring.

REPLACEABLE VALVE BRASS NUT & SNAP RING

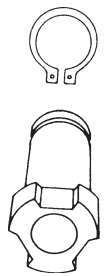

Snap Ring 3" and 4" valves
 Snap Ring 5" and 6" valves

Brass Nut 3" and 4" valves
 Brass Nut 5" and 6" valves

Product of: **TRAVIS PATTERN & FOUNDRY INC., SPOKANE, WASHINGTON**

Prices: SUBJECT TO CHANGE WITHOUT NOTICE

FAX: (509) 467-6465 - PHONE: (509) 466-3545

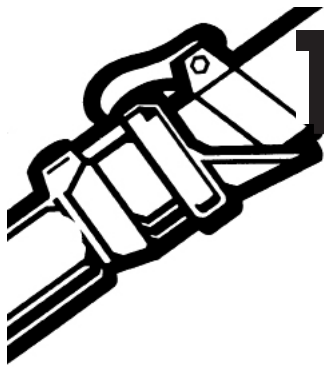

TRAVIS

UNIVERSAL PARTS

VALVE OPENER PARTS

Universal - Fits Travis/Rainway
and most other Universal Openers.

ALUMINUM OPENERS RAINWAY TYPE

ITEM #	SIZE	
	3"	4"
(A) UVEO Stem $\frac{5}{8}$ " , $9\frac{1}{4}$ " Length		
(B) UVEO T Crank $\frac{5}{8}$ " Aluminum		
UVEO T Crank $\frac{5}{8}$ " Steel		
(C) UVEO Yoke		
(D) UVEO Gland Nut		
UVEO Packing		
(F) UVEO Ring Lock Clamp		
(G) UVEO Roll Pin $1\frac{1}{4}$ "		
(H) UVEO Roll Pin $1\frac{1}{2}$ "		

* See A&M, Moore Rane Sections for parts

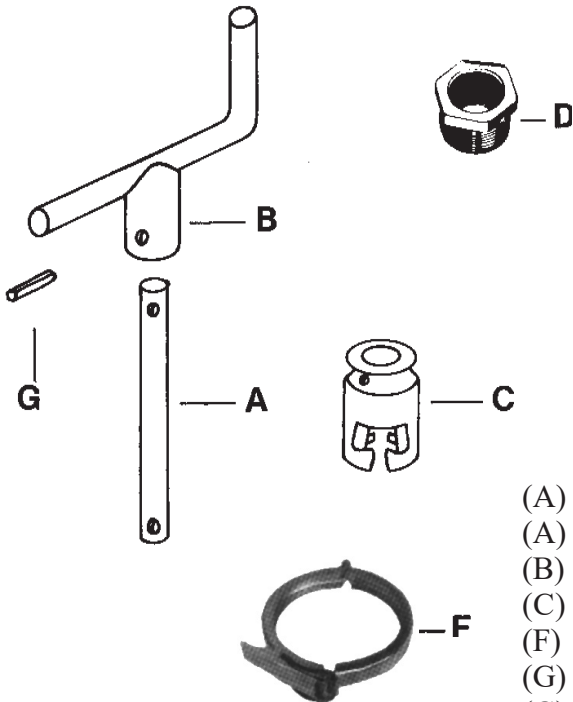

STEEL OPENERS WESTERN & PIERCE TYPE

ITEM #	SIZE				
	3"	4"	5"	6"	8"
(A) SUVEO Stem $\frac{3}{4}$ " $9\frac{1}{4}$ " Length					
(A) SUVEO Stem $\frac{3}{4}$ " 12" Length					
(B) SUVEO T Crank $\frac{3}{4}$ " Steel					
(C) SUVEO Yoke					
(F) SUVEO Ring Lock Clamp					
(G) SUVEO Roll Pin 1"					
(G) SUVEO Roll Pin $1\frac{1}{4}$ "					
Chevron $\frac{3}{4}$ "					
1 pc. $\frac{3}{4}$ " Shaft 9" Long Socket Assy.					
1 pc. $\frac{3}{4}$ " Shaft 15" Long Socket Assy.					

(C) Fits both $\frac{5}{8}$ " & $\frac{3}{4}$ " stems.

Breakdown on A&M and Moore Rane Valve Openers.

IMPORTANT NOTICE:

Stems, Discs, Valve Opener Parts
Flapper and Mushroom Drains, Clamps, Bands, etc.
are interchangeable with most brands.
Contact us for assistance in replacement parts.

Many other manufacturer's gaskets available. Call factory.

Product of: **TRAVIS PATTERN & FOUNDRY INC., SPOKANE, WASHINGTON**

Prices: SUBJECT TO CHANGE WITHOUT NOTICE

FAX: (509) 467-6465 - PHONE: (509) 466-3545

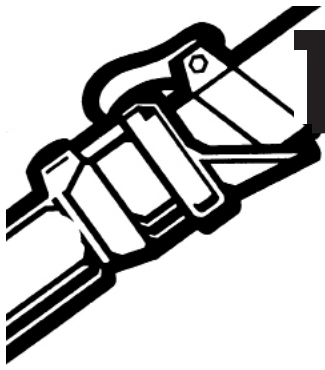

RAINWAY GASKETS SQUARE BACK

FOR FULL BOX QUANTITIES ADD "FB" TO END OF PART NUMBER
example-E 1 3" FB

SIZE	DRAIN	NON DRAIN	APPROX. FULL BOX QUANTITY	
			QUANTITY	QUANTITY
2"	E-2 2"	—	1000	
3"	E-2 3"	E-1 3"	500	
4"	*E-2 4"	E-1 4"	400	
5"		E-1 5"	300	
6"		E-1 6"	250	
7"		E-1 7"	225	
8"		E-1 8"	200	
10"		E-1 10"	125	
12"		E-1 12"	75	
		E-3 12" (New Style)	75	
Old Style Rainway Round Back				
2"		E-3 2RW"	500	
3"		E-3 3RW"	500	

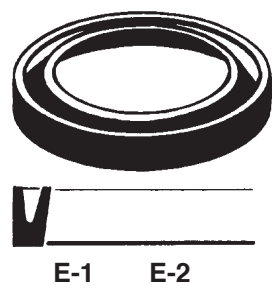

Call Factory For Quantity Prices Over Full Box
*Substitute G42 Interchangeable w/E 2 4

ROUND BACK GASKETS

Gaskets for Rainway Steel Couplers
(interchangeable with Pierce)

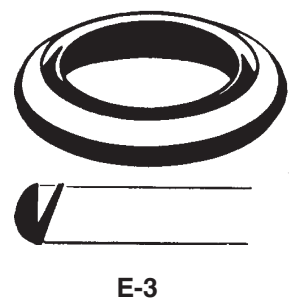

SIZE	DESIGNATION	APPROX. FULL BOX QTY.
2"	E-3 2"	900
3"	E-3 3"	500
4"	E-3 4"	250
5"	E-3 5"	200
6"	E-3 6"	150
7"	E-3 7"	150
8"	E-3 8"	100
10"	E-3 10"	100
12"	E-3 12"	75

Call Factory For Quantity Prices Over Full Box

Product of: **TRAVIS PATTERN & FOUNDRY INC., SPOKANE, WASHINGTON**

Prices: SUBJECT TO CHANGE WITHOUT NOTICE

FAX: (509) 467-6465 - PHONE: (509) 466-3545

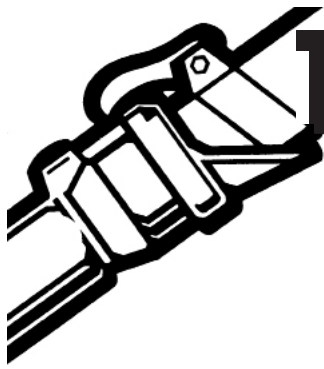

A&M GASKETS

FOR FULL BOX QUANTITIES ADD "FB" TO END OF PART NUMBER

example-G 32 FB



DRAIN		<i>APPROX. FULL</i>
<i>SIZE</i>	<i>DESIGNATION</i>	<i>BOX QTY.</i>
2"	G 22	1000
3"	G 32	500
4"	G 42	300
5"	G 52	250
6"	G 62	200
8"	G 82	150

NON DRAIN

2"	G 23	1000
3"	G 33	500
4"	G 43	300
*4½"	G 452	250
5"	G 53	250
6"	G 63	200
7"	G 73	175
8"	G 83	150
10"	G 103	100

Gasket numbers are stamped on the inside lip of each gasket.

* 4½" special V.O. Gasket G 452.

HIGH PRESSURE OR SOLID SET A&M 55 Series Couplers

3"	3G 5	300
4"	4G 5	300
5"	5G 5	250
6"	6G 5	250
8"	8G 5	175
10"	10G 5	150

Call Factory For Quantity Prices Over Full Box

Product of: **TRAVIS PATTERN & FOUNDRY INC., SPOKANE, WASHINGTON**

Prices: SUBJECT TO CHANGE WITHOUT NOTICE

FAX: (509) 467-6465 - PHONE: (509) 466-3545

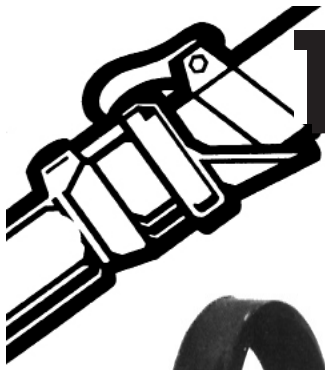

MOORE RANE GASKETS

FOR FULL BOX QUANTITIES ADD "FB" TO END OF PART NUMBER

example-3NDG FB

**NON DRAIN
WIDE STYLE**



<i>SIZE</i>	<i>DESIGNATION</i>	<i>APPROX. FULL BOX QTY.</i>
2"	2NDG	700
3"	3NDG	400
4"	4NDG	200
5"	5NDG	150
6"	6NDG	100
7"	7NDG	100
8"	8NDG	100
10"	10NDG	75

**SOLID-LOCK
NARROW STYLE**



2"	G 22	1000
2"	G 23	1000
3"	E 2 3	500
3"	E 1 3	500

WESTERN SQUARE BACK GASKETS

FOR FULL BOX QUANTITIES ADD "FB" TO END OF PART NUMBER

example-G 28 FB

NON DRAIN



<i>SIZE</i>	<i>DESIGNATION</i>	<i>APPROX. FULL BOX QTY.</i>
2"	G 28	700
3"	G 38	400
4"	G 48	250
5"	G 58	200
6"	G 68	150
7"	G 78	125
8"	G 88	100
10"	G 108	100
12"	G 128	75

DRAIN

Call Factory For Quantity Prices Over Full Box

3"	G 39	400
4"	G 49	250

Product of: **TRAVIS PATTERN & FOUNDRY INC., SPOKANE, WASHINGTON**

Prices: SUBJECT TO CHANGE WITHOUT NOTICE

FAX: (509) 467-6465 - PHONE: (509) 466-3545

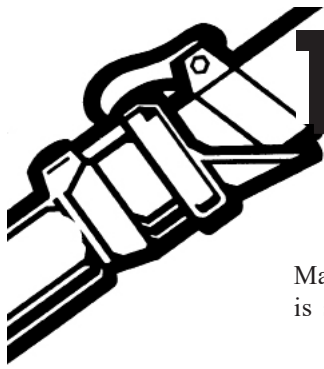

FELCO GASKETS

Material consists of ethylene propylene rubber (EBR) having excellent ozone and weather resistance and is serviceable under temperature variations normally encountered in agricultural irrigation applications.

	<i>SIZE</i>	<i>DESIGNATION</i>	<i>WT.</i>
Drain Type	2"	1706-1	0.06 lbs
	3"	1586-1	0.10
	4"	1588-1	0.11
Non-Drain Type	3"	1587-1	0.10
	4"	1589-1	0.11
	5"	1232-4	0.28
	6"	1232-5	0.31
	7"	1574-1	0.34
	8"	1860-2	0.37
	10"	1232-9	0.54

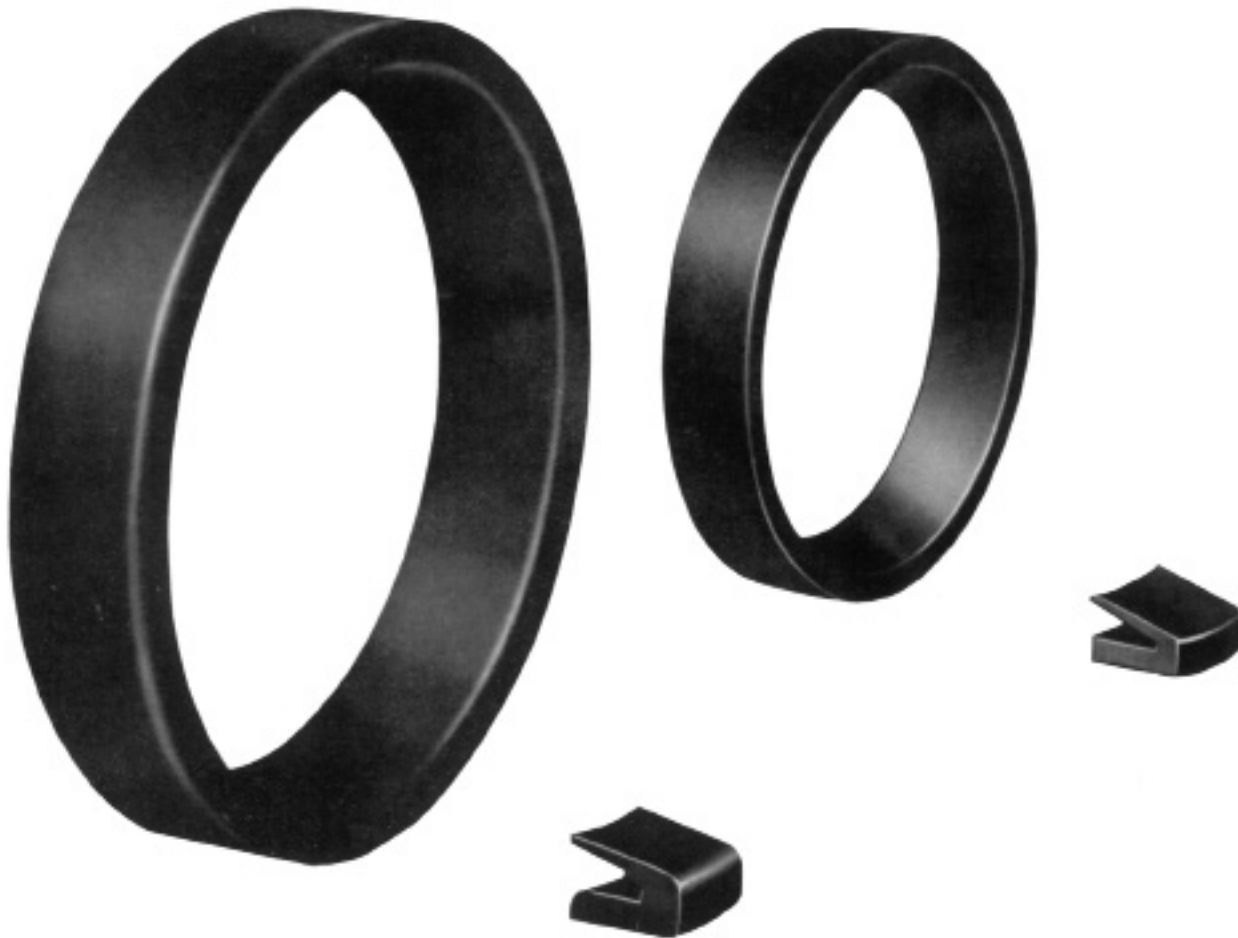

Product of: **TRAVIS PATTERN & FOUNDRY INC., SPOKANE, WASHINGTON**

Prices: SUBJECT TO CHANGE WITHOUT NOTICE

FAX: (509) 467-6465 - PHONE: (509) 466-3545



SHURE RANE DRAIN GASKETS

**Chevron type.
Highest quality rubber.**



<i>SIZE</i>	<i>DESIGNATION</i>	<i>APPROX. FULL BOX QTY.</i>
2"	SRD 2G	300
3"	SRD 3G	160
4"	SRD 4G	100
5"	SRD 5G	75
6"	SRD 6G	50
8"	SRD 8G	30

**Chevron type.
Highest quality rubber.**



SHURE RANE NON DRAIN GASKETS

<i>SIZE</i>	<i>DESIGNATION</i>	<i>APPROX. FULL BOX QTY.</i>
3"	SRND 3G	160
4"	SRND 4G	100
5"	SRND 5G	75
6"	SRND 6G	50

AMES LO-HI GASKETS

<i>SIZE</i>	<i>DESIGNATION</i>	<i>APPROX. FULL BOX QTY.</i>
6"	AG6	125
8"	AG8	75
10"	AG10	50
12"	AG12	30

Other AMES style gaskets available - consult factory.

Product of: **TRAVIS PATTERN & FOUNDRY INC., SPOKANE, WASHINGTON**

Prices: SUBJECT TO CHANGE WITHOUT NOTICE

FAX: (509) 467-6465 - PHONE: (509) 466-3545



TRAVIS

UNIVERSAL PARTS



Used to glue in center bolt-on riser outlet gaskets and torque coupler 'O' rings. Larger quantities available upon request.

3M CEMENT

ITEM #	WT.
A-88	5 oz

MUSHROOM DRAIN



DESIGNATION	ITEM #	SIZE	BOX QTY.
Drain	D-2-5	Long	100
Clip	D-2-4-SC		100

TORQUE COUPLER 'O' RING

Box Quantity 200	PART NO.	DESCRIPTION	FITS	SIZE
	ORG	Travis/Western Round	Travis/Western Aluminum	4 7/8" OD X 4 1/2" ID
	200463	A& M Round	A& M Round	5" OD X 4 3/8" ID
	200470	A& M Square	A& M Square	5" OD X 4 1/2" ID
	200424	Trunnell Quad	Trunnell 4" steel Approx. 4 3/8" ctr. to ctr.	4 7/8" OD X 4 3/8" ID
	200425	Trunnell Quad	Trunnell 5" steel Approx. 5 1/2" ctr. to ctr.	5 7/8" OD X 5 1/4" ID
	200426	Trunnell Quad	Trunnell 4" & 5" Aluminum Approx. 4 3/4" ctr. to ctr.	5" OD X 4 1/2" ID
	300464	Western	Western Steel	5" OD X 4 3/4" ID

PRESSING COMPOUND



Used in aluminum tube fabrication.

ITEM #	DESCRIPTION
Forrest WNA-1F	A & B
Part A	Paint
Part B	Catalyst
Epoxy thinner	1 gal.

FLAPPER TYPE DRAIN VALVE

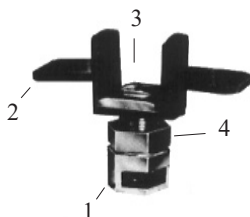

ITEM #	PART #
FD-100 complete	FD 100
FD- Splash Nut	FD Splash Nut
FD- Rubber Flapper	FD Flapper
FD- Insert	FD Insert
FD- Jam Nut	FD Jam Nut

Product of: **TRAVIS PATTERN & FOUNDRY INC., SPOKANE, WASHINGTON**

Prices: SUBJECT TO CHANGE WITHOUT NOTICE

FAX: (509) 467-6465 - PHONE: (509) 466-3545

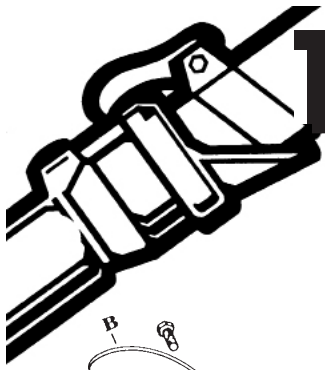

TRAVIS

UNIVERSAL PARTS

FULL BAND AND LATCH

(Including, Nut, Bolt and Ferrule)

SIZE	DESIGNATION	PRICE
2"		\$ 8.16
3"		8.45
4"	See Rainway,	9.99
5"	A&M, Western	14.22
6"	& Round Back	15.76
7"	Sections	18.06
8"		20.13
10"		21.89

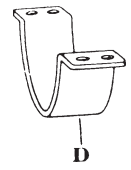
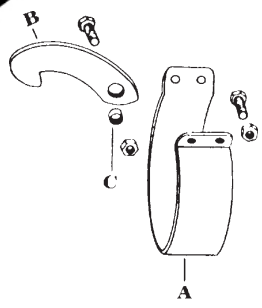

(A) FULL BAND ONLY

SIZE	DESIGNATION
2"	B200
3"	B300
4"	B400
5"	B500
6"	B600
7"	B700
8"	B800
10"	B1000

LOOSE FIT BAND ONLY

SIZE	DESIGNATION
2"	B200 OS
3"	B300 OS
4"	B400 OS
5"	B500 OS
6"	B600 OS

(B) OUTSIDE LATCH

Latch Rainway
 201007 Reg. A & M
 201012 Long. A & M
 And Moore Rane
 Latch Western
 Latch Pierce

(C) LATCH FERRULE

FERRULE "A" 5/16"
 FERRULE "B" 1/2"

RW Latch Spring
 201154 A & M
 Latch Spring

(D) COUPLER AND VALVE HALF BANDS

SIZE
3" Half Band
4" Half Band
5" Half Band

SIZE
6" Half Band

HIGH PRESSURE RING LOCK CLAMP



Heavy duty steel ringlock clamp.

* OVERSIZED
 TO FIT GATED
 PIPE BELL COUPLERS

SIZE	DESIGNATION	WT.	Box Qty	
3"	HPRLC 300	1.53 lbs	300	
4"	HPRLC 400	1.60	200	
5"	HPRLC 500	1.80	175	
6"	HPRLC 600	2.00	125	
*6"	HPRLC 600 TL	2.00	125	
7"	HPRLC 700	2.25	125	
8"	HPRLC 800	2.50	100	
*8"	HPRLC 800 TL	2.50	100	
10"	HPRLC 1000	3.25	80	
FITS STEEL ONLY	10"	HPRLC 1000S	3.50	80
	12"	HPRLC 1200	3.75	75
FITS STEEL ONLY	12"	HPRLC 1200S	3.75	75

HOLD BANDS



Call Factory For
 Large Quantity Prices

STEEL ITEM #	ALUM. ITEM #	WEIGHT PER 100 ALUM.	WEIGHT PER 100 STEEL	SIZE	STEEL	ALUM.
	HB-300	—	—	3"		
SHB-4	HB-400	13.00 lbs	30.00 lbs	4"		
SHB-5	HB-500	16.00	38.00	5"		
SHB-6	HB-600	19.00	50.00	6"		
SHB-8	HB-800	44.00	75.00	8"		
SHB-10	HB-1000	63.00	88.00	10"		
SHB-12		—	100.00	12"		

Product of: **TRAVIS PATTERN & FOUNDRY INC., SPOKANE, WASHINGTON**

Prices: SUBJECT TO CHANGE WITHOUT NOTICE

FAX: (509) 467-6465 - PHONE: (509) 466-3545

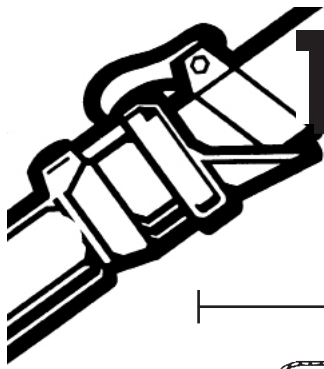

TRAVIS

UNIVERSAL PARTS

GALVANIZED CHECK VALVES

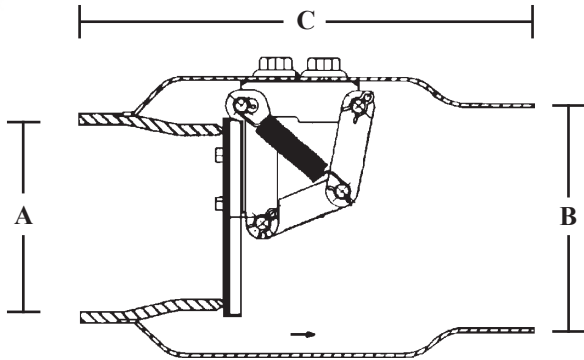

SIZE	PART NO.
4"	CKVP 4
6"	CKVP 6
8"	CKVP 8
10"	CKVP 10

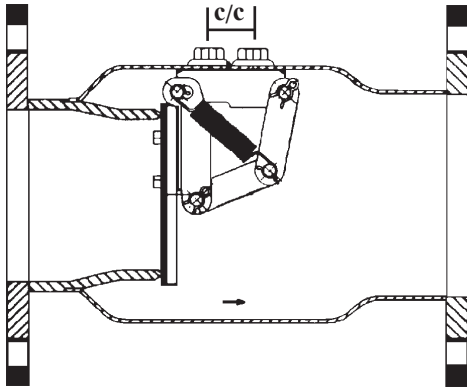

SIZE	PART NO.
4"	CKV FL 4
6"	CKV FL 6
8"	CKV FL 8
10"	CKV FL 10

AVAILABLE WITH RINGLOCK ENDS ALSO.
CALL FOR INFORMATION AND OPTIONS



Dimensions

	A	B	C	D	C/C
4"	4"	4.75"	10.25"	11.25"	2.0"
6"	6"	6.75"	12.75"	13.75"	2.5"
8"	8"	9.25"	15.0"	16.0"	3.5"
10"	10"	11.5"	18.25"	19.25"	4.0"

REPLACEMENT PARTS

PART NO.	SIZE	DESCRIPTION
CKV L 4	4"	STAINLESS STEEL LINKAGE KIT 4"
CKV L 6	6"	STAINLESS STEEL LINKAGE KIT 6"
CKV L 8	8"	STAINLESS STEEL LINKAGE KIT 8"
CKV L 10	10"	STAINLESS STEEL LINKAGE KIT 10"
SS LINK BOLTS		3/8" X 1" STAINLESS STEEL BOLTS (2 REQUIRED)
SS WASHERS		3/8" STAINLESS STEEL WASHERS (2 REQUIRED)

Product of: **TRAVIS PATTERN & FOUNDRY INC., SPOKANE, WASHINGTON**

Prices: SUBJECT TO CHANGE WITHOUT NOTICE

FAX: (509) 467-6465 - PHONE: (509) 466-3545

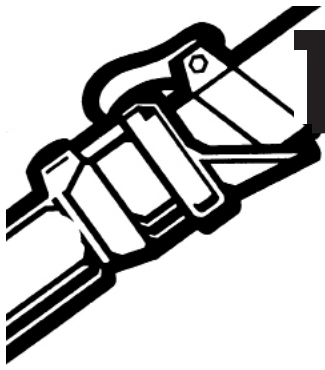

BUTTERFLY LINE VALVE



RING LOCK

SIZE	DESIGNATION	WT.
4"	SRLBV 400	11.00 lbs
6"	SRLBV 600	19.00
8"	SRLBV 800	29.00
10"	SRLBV 1000	43.00
**12"	SRLBV 1200	49.00

** Uses 10" body."

BAND AND LATCH

4"	BLSBV 400	14.00
6"	BLSBV 600	24.00
8"	BLSBV 800	35.00
10"	BLSBV 1000	41.00

FLANGED

4"	BVFL 400	25.00
6"	BVFL 600	35.00
8"	BVFL 800	56.00
10"	BVFL 1000	70.00

PLAIN

4"	BV 400	12.00
6"	BV 600	20.00
8"	BV 800	31.00
10"	BV 1000	36.00

*Price is for galvanized, Also available epoxy coated.
See Epoxy Section for pricing.

Product of: **TRAVIS PATTERN & FOUNDRY INC., SPOKANE, WASHINGTON**

Prices: SUBJECT TO CHANGE WITHOUT NOTICE

FAX: (509) 467-6465 - PHONE: (509) 466-3545

BUTTERFLY LINE VALVE PARTS

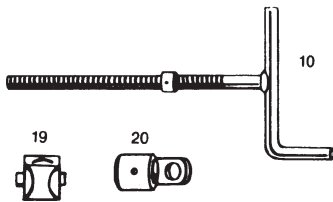
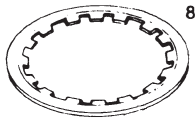
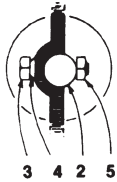
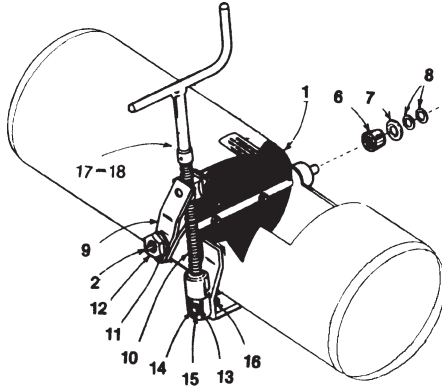
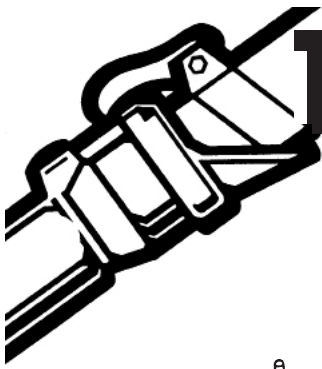

PART No.	QTY. REQ.	SIZE	DESCRIPTION
BLV 1-4	1	4"	Disc
BLV 1-6	1	6"	
BLV 1-8	1	8"	
BLV 1-10	1	10"	
BLV 2-4	1	4"	Shaft $\frac{3}{4}$ " x 8- $\frac{1}{4}$ "
BLV 2-6	1	6"	1" x 10"
BLV 2-8	1	8"	1" x 12"
BLV 2-10	1	10"	1" x 14- $\frac{1}{4}$ "
BLV 3-4	2	4"	Bolt, Stainless $\frac{5}{16}$ " x 1- $\frac{1}{2}$ "
BLV 3-6, 3-8	2	6" & 8"	$\frac{3}{8}$ " x 2- $\frac{1}{4}$ "
BLV 3-10	3	10"	$\frac{3}{8}$ " x 2- $\frac{1}{4}$ "
BLV 4-4	2	4"	Washer, Brass $\frac{5}{16}$ "
BLV 4-6, 4-8	2	6" & 8"	Neuprene $\frac{3}{8}$ "
BLV 4-10	3	10"	Neuprene $\frac{3}{8}$ "
BLV 5-4	2	4"	Nut, Brass $\frac{5}{16}$ "
BLV 5-6, 5-8	2	6" & 8"	$\frac{3}{8}$ "
BLV 5-10	3	10"	$\frac{3}{8}$ "
BLV 6-4	2	4"	Gasket, Chevron $\frac{3}{4}$ "
BLV 6-6, 6-8, 6-10	2	6" Thru 10"	1"
BLV 7-4	2	4"	Washer, Reducing $\frac{3}{4}$ " x $\frac{1}{2}$ "
BLV 7-6, 7-8, 7-10	2	6" Thru 10"	1" x $\frac{3}{4}$ "
BLV 8-4	4	4"	Ring, Retaining $\frac{3}{4}$ "
BLV 8-6, 8-8, 8-10	4	6" Thru 10"	1"
BLV 9	2	4" Thru 10"	Arm Linkage
BLV 10	1	4" Thru 10"	Stem & Handle
BLV 11	1	4" Thru 10"	Washer, Star $\frac{3}{4}$ "
BLV 12	1	4" Thru 10"	Jam Nut $\frac{3}{4}$ "
BLV 13	1	4" Thru 10"	Ferrule $\frac{3}{8}$ " x $\frac{5}{16}$ "
BLV 14	1	4" Thru 10"	Bolt $\frac{3}{8}$ " x 1- $\frac{1}{2}$ "
BLV 15	1	4" Thru 10"	Washer $\frac{3}{8}$ "
BLV 16	1	4" Thru 10"	Nut $\frac{3}{8}$ " locknut
BLV 17	2	4" Thru 10"	Collar $\frac{5}{8}$ "
BLV 18	2	4" Thru 10"	Roll Pin $\frac{3}{16}$ " x $\frac{7}{8}$ "
BLV 19	1	4" Thru 10"	Thrust Nut
BLV 20	1	4" Thru 10"	Yoke

Product of: **TRAVIS PATTERN & FOUNDRY INC., SPOKANE, WASHINGTON**

Prices: SUBJECT TO CHANGE WITHOUT NOTICE

FAX: (509) 467-6465 - PHONE: (509) 466-3545

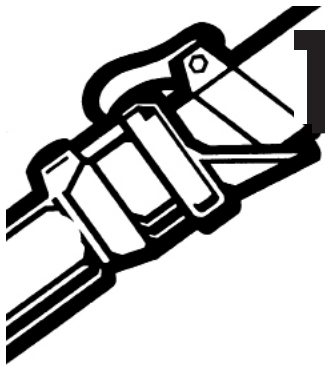

RING LOCK DISCHARGE ADAPTOR



Connects pump to ringlock mainline

*Available with flange add FL to PN-Same price

SIZE	DESIGNATION	WT.
4" x 4"	SRLDA404	7.00 lbs
4" x 5"	SRLDA405	8.00
4" x 6"	SRLDA406	10.00
5" x 5"	SRLDA505	9.00
5" x 6"	SRLDA506	10.00
5" x 8"	SRLDA508	14.00
6" x 6"	SRLDA606	15.00
6" x 8"	SRLDA608	16.00
6" x 10"	SRLDA610	20.00
8" x 8"	SRLDA808	17.00
8" x 10"	SRLDA810	22.00

BAND AND LATCH DISCHARGE ADAPTOR



*Add 1" Fipt or 3/4" Fipt Outlet - \$10.00 Net

*Available with flange add FL to PN-Same price.

Other sizes available upon request.

SIZE	DESIGNATION	WT.
2" x 3"	BLSDA203	3.00 lbs
3" x 3"	BLSDA303	4.00
3" x 4"	BLSDA304	5.00
4" x 4"	BLSDA404	6.00
4" x 5"	BLSDA405	7.00
4" x 6"	BLSDA406	9.00
4" x 7"	BLSDA407	11.00
5" x 5"	BLSDA505	7.00
5" x 6"	BLSDA506	9.00
5" x 7"	BLSDA507	12.00
5" x 8"	BLSDA508	14.00
6" x 6"	BLSDA606	15.00
6" x 7"	BLSDA607	16.00
6" x 8"	BLSDA608	17.00

SUCTION ADAPTOR — STEEL*



Connects pump to suction line

*Other sizes available upon request.

*Available with flange add FL to PN-Same price

* Add 3/4" fipt or 1" fipt outlet - Add \$10.00 Net

SIZE	DESIGNATION	WT.
3" x 3"	SSA3003	4.00 lbs
3" x 4"	SSA3004	4.00
4" x 4"	SSA4004	5.00
4" x 5"	SSA4005	7.00
4" x 6"	SSA4006	8.00
4" x 7"	SSA4007	10.00
5" x 5"	SSA5005	8.00
5" x 6"	SSA5006	9.00
5" x 7"	SSA5007	10.00
5" x 8"	SSA5008	12.00
6" x 6"	SSA6006	13.00
6" x 7"	SSA6007	14.00
6" x 8"	SSA6008	16.00
8" x 8"	SSA8008	17.00

Product of: **TRAVIS PATTERN & FOUNDRY INC., SPOKANE, WASHINGTON**

Prices: SUBJECT TO CHANGE WITHOUT NOTICE

FAX: (509) 467-6465 - PHONE: (509) 466-3545

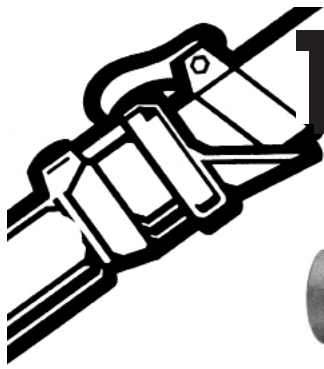

ALUMINUM SUCTION ADAPTER



Aluminum construction. For connecting suction pipe to pumping unit.

SIZE	DESIGNATION	WT.	SIZE	DESIGNATION	WT.
1½ x 3	SA 1503	1.50 lbs	3 x 6	SA 3006	4.00 lbs
2 x 3	SA 2003	2.00	4 x 6	SA 4006	4.00
2½ x 3	SA 2503	2.00	5 x 6	SA 5006	4.00
3 x 3	SA 3003	2.00	6 x 6	SA 6006	4.00
2 x 4	SA 2004	2.50	5 x 7	SA 5007	4.50
3 x 4	SA 3004	2.50	6 x 7	SA 6007	4.50
4 x 4	SA 4004	2.50	7 x 7	SA 7007	4.50
3 x 5	SA 3005	3.00	5 x 8	SA 5008	5.00
4 x 5	SA 4005	3.00	6 x 8	SA 6008	5.00
5 x 5	SA 5005	3.00	7 x 8	SA 7008	5.25
			8 x 8	SA 8008	5.25

For other sizes please contact factory



ALUMINUM DISCHARGE ADAPTER

Aluminum construction. For connecting main line to pumping unit.

SIZE	DESIGNATION	WT.	SIZE	DESIGNATION	WT.
1½ x 2	DA 1502	1.50 lbs	3 x 5	DA 3005	3.00 lbs
2 x 2	DA 2002	1.50	4 x 5	DA 4005	3.00
1½ x 3	DA 1503	2.00	3 x 6	DA 3006	4.00
2 x 3	DA 2003	2.00	4 x 6	DA 4006	4.00
3 x 3	DA 3003	2.00	5 x 6	DA 5006	4.50
1½ x 4	DA 1504	2.50	6 x 6	DA 6006	5.00
2 x 4	DA 2004	2.50	6 x 7	DA 6007	6.00
3 x 4	DA 3004	2.50	6 x 8	DA 6008	7.00
4 x 4	DA 4004	3.00	8 x 8	DA 8008	10.00

For other sizes please contact factory

Product of: **TRAVIS PATTERN & FOUNDRY INC., SPOKANE, WASHINGTON**

Prices: SUBJECT TO CHANGE WITHOUT NOTICE

FAX: (509) 467-6465 - PHONE: (509) 466-3545

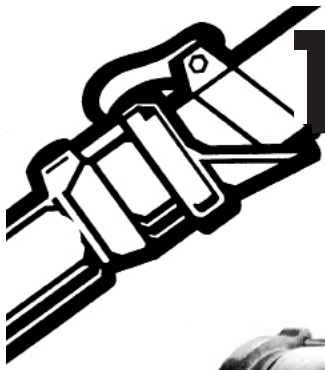

CAST ALUMINUM COUPLINGS FOR DRESSER TYPE CONNECTIONS

For suction line and operating pressures to 30 PSI.

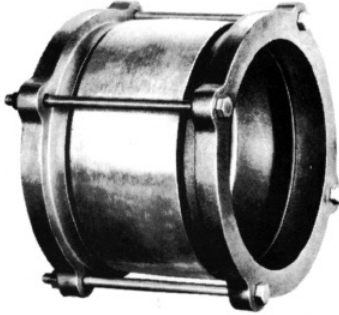

<i>SIZE</i>	<i>DESIGNATION</i>	<i>WT.</i>
2"	SFC-2	2.5 lbs.
3"	SFC-3	3.1 lbs.
4"	SFC-4	3.7 lbs.
5"	SFC-5	4.9 lbs.
6"	SFC-6	5.8 lbs.
8"	SFC-8	7.0 lbs.
10"	SFC-10	9.9 lbs.

CAST ALUMINUM SUCTION ELBOW — 45° & 90°

Suction elbow for dresser type connection includes gaskets, nuts and bolts. Elbows are limited to 30 PSI operating pressure.

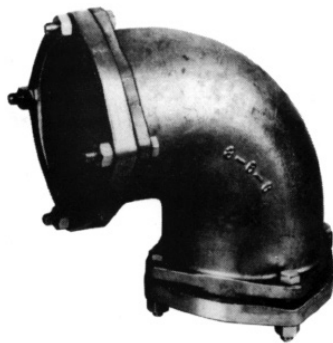

<i>SIZE</i>	<i>TYPE</i>	<i>ITEM #</i>	<i>WT.</i>
2"	90°	3-2C	4.0 lbs
3"	90°	3-3C	5.3 lbs
4"	90°	3-4C	7.1 lbs
5"	90°	3-5C	9.5 lbs
6"	90°	3-6C	11.5 lbs
8"	90°	3-8C	13.5 lbs
10"	90°	3-10C	19.4 lbs
2"	45°	3-2C45°	4.0 lbs
3"	45°	3-3C45°	5.3 lbs
4"	45°	3-4C45°	7.1 lbs
5"	45°	3-5C45°	9.5 lbs
6"	45°	3-6C45°	11.5 lbs
8"	45°	3-8C45°	13.5 lbs
10"	45°	3-10C45°	19.4 lbs

Product of: **TRAVIS PATTERN & FOUNDRY INC., SPOKANE, WASHINGTON**

Prices: SUBJECT TO CHANGE WITHOUT NOTICE

FAX: (509) 467-6465 - PHONE: (509) 466-3545

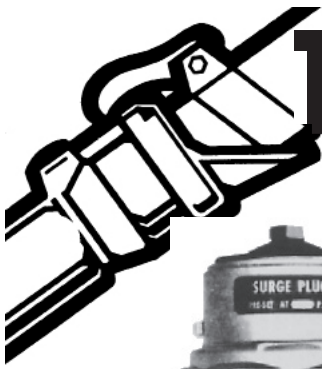

PRESSURE RELIEF VALVES

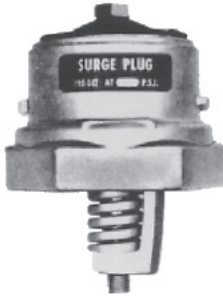

SEP 41
SEP 43

Pre-set at factory to release at 80 PSI. Contact factory for higher or lower setting.

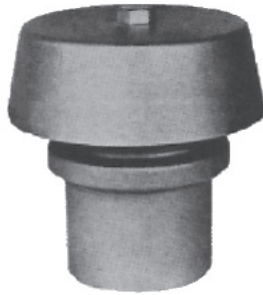

SEP 4325 SP

Pre-set at factory at 80 PSI. Contact factory for higher or lower setting.

SIZE	DESIGNATION	WT.
4" FPT	SEP 41	5.50 lbs
4" FPT	*SEP 43	6.00
4" FPT	*SEP43 SP	7.00

*For settings 125 to 180 PSI.

3" FPT	SEP 4325	5.00 lbs
3" FPT	SEP 4325SP	6.00

Splash pan (SP) is optional

PART NO.	PARTS DESCRIPTION
203010	Red Spring for SEP 41 & SEP 4325
203023	Black Spring for SEP 43
202991	Fork Assy. for SEP 41 & SEP 4325
202992	Fork Assy. for SEP 43
202025	Black Bolt 5/8 X 8 Fits SEP 41, 43 & 4325



Adjustable from 30-125 P.S.I.. Large spring for consistent setting repetition. Gauge port and jam nut included. Standard factory setting is 80 P.S.I. and un-sealed. Can be factory set at other pressures, stamped and sealed-add \$10.00 net.

CAST ALUMINUM PRESSURE RELIEF VALVE

SIZE	DESIGNATION	WT.
2"	PRV 200	10.00 lbs
3"	PRV 300	10.75lbs



CAST ALUMINUM DIAPHRAGM PRIMING PUMP

SIZE	DESIGNATION	WT.
1" Inlet	9-30	8.1 lbs

Priming Pump has approximate 100 cubic inch displacement per stroke. Fitted with 1" male thread for connection.

9-30 Diaphragm Pump Parts

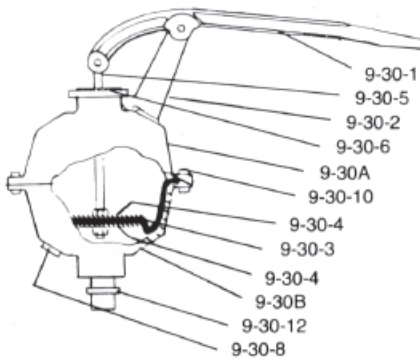

Part Number	Description	Required	Weight
9-30A	Body, top half	1	2.0 lbs.
9-30B	Body, lower half	1	2.0 lbs.
9-30-1	Handle	1	1.0 lbs.
9-30-2	Handle Support	1	0.5 lbs.
9-30-3	Rubber Diaphragm	1	0.4 lbs.
9-30-4	Steel Diaphragm	2	0.6 lbs.
9-30-5	Connecting Rod & Nut	1	0.3 lbs.
9-30-6	Handle Bracket Lock Nut	1	0.4 lbs.
9-30-8	Rubber Discharge Valve	1	0.1 lbs.
9-30-12	Ball Check Valve w/Ball	1	0.2 lbs.
9-30-133/4"	Stainless Ball only	1	0.1 lbs.

Product of: **TRAVIS PATTERN & FOUNDRY INC., SPOKANE, WASHINGTON**

Prices: SUBJECT TO CHANGE WITHOUT NOTICE

FAX: (509) 467-6465 - PHONE: (509) 466-3545

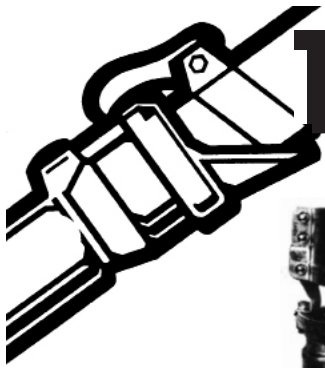

TRAVIS

UNIVERSAL PARTS

CAST ALUMINUM FOOT VALVES

Foot Valves have dresser type connection for use with O. D. tubing only. Complete assembly includes slotted strainer and safety ring and link for connection to suction tube.

<i>SIZE</i>	<i>DESIGNATION</i>	<i>WT.</i>
3"	9-13C	5.3 lbs
4"	9-14C	8.9 lbs
5"	9-15C	13.6 lbs
6"	9-16C	13.4 lbs
8"	9-18C (45°)	31.5 lbs



CAST ALUMINUM FOOT VALVES with Large Area Steel Strainer

Complete Foot Valve assembly with large area steel strainer for connection to O. D. tubing. Includes dresser type connection with safety ring and link. 8" diameter Foot Valve will NOT fit this strainer series.

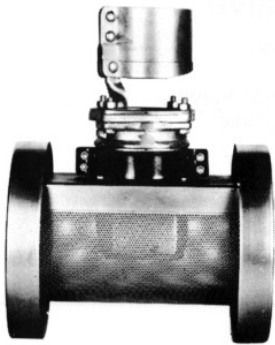

<i>FOOT VALVE</i>			<i>STRAINER</i>
<i>SIZE</i>	<i>DESIGNATION</i>	<i>WT.</i>	<i>LENGTH</i>
3"	9-43 3"	25.4 lbs	18"
4"	9-43 4"	29.1 lbs	18"
5"	9-43 5"	35.3 lbs	24"
6"	9-43 6"	35.1 lbs	24"

BARE STRAINER ONLY

All strainers have 8" diameter opening to accommodate 3" through 6" Foot Valve sizes. Strainers must be ordered with adapters for connection to iron pipe, O. D. tube or existing Foot Valves.

NOTE: 48" strainer has no bolt holes for adapter.

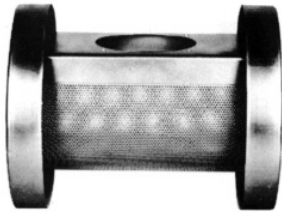

<i>DESIGNATION</i>	<i>WT.</i>	<i>TOTAL</i>	
		<i>OPEN AREA</i>	<i>LENGTH</i>
9-40-18	17.0 lbs	158 in ²	18"
9-40-24	19.0 lbs	202 in ²	24"
9-40-48	28.0 lbs	373 in ²	48"

IRON PIPE STRAINER ADAPTER FOR 9-40 STRAINER

FEMALE THREAD

<i>IRON PIPE SIZE</i>	<i>DESIGNATION</i>	<i>WT.</i>
3"	9-40-1 3"	3.6 lbs
4"	9-40-1 4"	4.0 lbs
5"	9-40-1 5"	5.6 lbs
6"	9-40-1 6"	8.5 lbs
8"	9-40-1 8"	10.3 lbs



"8" Adapter must be welded to Strainer rather than Bolted.

Product of: **TRAVIS PATTERN & FOUNDRY INC., SPOKANE, WASHINGTON**

Prices: SUBJECT TO CHANGE WITHOUT NOTICE

FAX: (509) 467-6465 - PHONE: (509) 466-3545

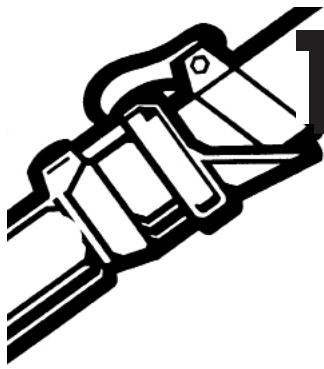

O. D. TUBE ADAPTER FOR 9-40 STRAINER

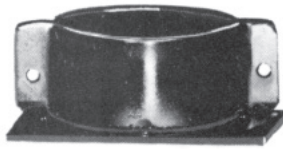

<i>O.D.</i>	<i>TUBE SIZE</i>	<i>DESIGNATION</i>	<i>WT.</i>
	3"	9-40-2 3"	3.1 lbs
	4"	9-40-2 4"	3.1 lbs
	5"	9-40-2 5"	3.0 lbs
	6"	9-40-2 6"	3.0 lbs
	8"	9-40-2 8"(welded)	4.4 lbs

Use to adapt bare tube only to strainer

ADAPTER FOR CONNECTION 9-40 STRAINER TO FOOT VALVE

8" foot Valve will NOT fit in 9-40 strainer.

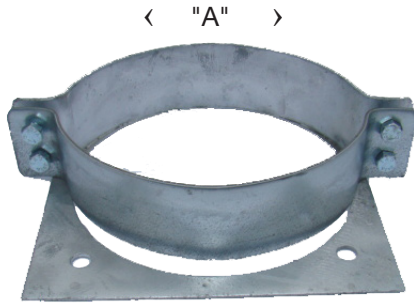

<i>FOOT VALVE</i>		<i>DIAMETER</i>	
<i>SIZE</i>	<i>DESIGNATION</i>	<i>WT.</i>	<i>"A"</i>
3"	9-40-3 3"	3.3 lbs	4-7/8"
4"	9-40-3 4"	3.5 lbs	5-7/8"
5"	9-40-3 5"	3.0 lbs	6-7/8"
6"	9-40-3 6"	3.0 lbs	6-7/8"

BARE FOOT VALVE FOR 9-40 STRAINER



<i>SIZE</i>	<i>DESIGNATION</i>	<i>WT.</i>
3"	9-40-4 3"	4.8 lbs
4"	9-40-4 4"	7.9 lbs
5"	9-40-4 5"	12.3 lbs
6"	9-40-4 6"	12.1 lbs

Product of: **TRAVIS PATTERN & FOUNDRY INC., SPOKANE, WASHINGTON**

Prices: SUBJECT TO CHANGE WITHOUT NOTICE

FAX: (509) 467-6465 - PHONE: (509) 466-3545

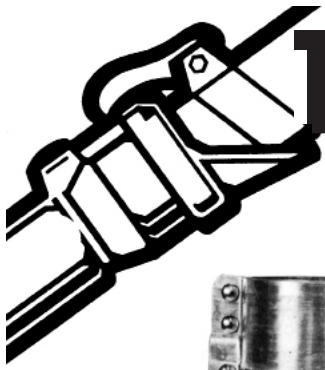

VALVES AND MISCELLANEOUS

Foot Valve Parts

SAFETY RING AND LINK

Part Number	Size	Weight
9-20-3	3"	0.8 lbs.
9-20-4	4"	0.8 lbs.
9-20-5	5"	1.0 lbs.
9-20-6	6"	1.1 lbs.
9-20 ...Safety Link, only ...	All	.3 lbs.



VALVE SCREEN

Part Number	Size	Weight
9-13-3	3"	0.5 lbs.
9-14-3	4"	1.0 lbs.
9-15-3	5"	1.5 lbs.
9-16-3	6"	1.5 lbs.

FLAPPER ASSEMBLY

Part Number	Size	Weight
10-9-1-3	3"	0.8 lbs.
10-9-1-4	4"	0.8 lbs.
10-9-1-6	5" & 6"	1.0 lbs.

RUBBER FLAPPER

Part Number	Size	Weight
10-9-2-3	3"	0.1 lbs.
10-9-2-4	4"	0.25 lbs.
10-9-2-6	5" & 6"	0.5 lbs.



HINGE SCREW

Part Number	Size	Weight
4227	All	1.0 oz.



UPPER STEEL DISC

Part Number	Size
10-9-3-3	3"
10-9-3-4	4"
10-9-3-5	5" & 6"

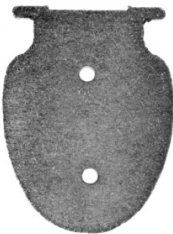

LOWER STEEL DISC

Part Number	Size
10-9-4-3	3"
10-9-4-4	4"
10-9-4-6	5" & 6"



TOP CLAMP RINGS

Part Number	Size	Weight
9-13-C1	3"	0.5 lbs.
9-14-C1	4"	0.7 lbs.
9-15-C1	5"	0.9 lbs.
9-16-C1	6"	1.1 lbs.
9-18-C1	8"	1.3 lbs.



Product of: **TRAVIS PATTERN & FOUNDRY INC., SPOKANE, WASHINGTON**

Prices: SUBJECT TO CHANGE WITHOUT NOTICE

FAX: (509) 467-6465 - PHONE: (509) 466-3545

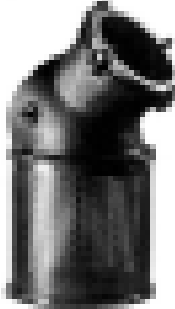
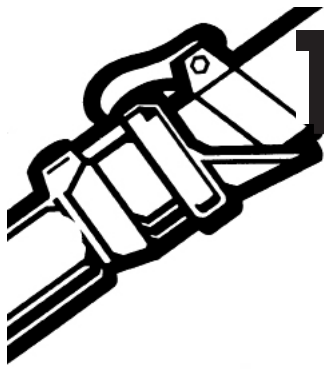

Aluminum Foot Valve with Standard (45°) OD Tubing

Combining an attachment coupling, 1 45° elbow, a foot valve and a strainer, this aluminum foot valve fulfills every requirement. A half inch female pipe thread is provided for drainage. Made entirely of aluminum except for the bolts, rubber gaskets and valve flapper, this valve is light in weight yet sturdy and efficient.

Part Number	Weight	OD Tubing Size
9-SFV2.....	5.0 lbs.	2"
9-SFV3.....	7.5 lbs.	3"
9-SFV4.....	10.5 lbs.	4"
9-SFV5.....	15.5 lbs.	5"
9-SFV6.....	18.0 lbs.	6"
9-SFV8.....	31.5 lbs.	8"
9-SFV10	46.0 lbs.	10"
		12"*

* See 12" Vertical Companion Valve on next page



Aluminum Foot Valve with Standard (45°) Companion Flange

This foot valve matches the bolt pattern of a standard 125 pound cast iron companion flange or a schedule 80 PVC flange.

Part Number	Weight	Companion Flange Size
9-SFV2-CF	6.5 lbs.	2"
9-SFV3-CF	10.0 lbs.	3"
9-SFV4-CF	14.5 lbs.	4"
9-SFV5-CF	20.5 lbs.	5"
9-SFV6-CF	24.0 lbs.	6"
9-SFV8-CF	43.0 lbs.	8"
9-SFV10-CF	66.0 lbs.	10"
		12"*

* See 12" Vertical Companion Valve on next page



Aluminum Foot Valve with Standard (45°) Female Thread

This 45° foot valve attaches to a NPT thread end, hose, steel pipe or PVC

Part Number	Weight	Thread Size
9-SFV2FP	5.0 lbs.	2"
9-SFV3FP	8.0 lbs.	3"
9-SFV4FP	11.0 lbs.	4"
9-SFV5FP	16.0 lbs.	5"
9-SFV6FP	18.5 lbs.	6"
9-SFV8FP	32.5 lbs.	8"
9-SFV10FP	47.5 lbs.	10"

Product of: **TRAVIS PATTERN & FOUNDRY INC., SPOKANE, WASHINGTON**

Prices: SUBJECT TO CHANGE WITHOUT NOTICE

FAX: (509) 467-6465 - PHONE: (509) 466-3545



UNIVERSAL PARTS

Aluminum Foot Valve with Vertical OD Tubing

Especially suitable where the aluminum tubing used for suction is to be in a vertical position. However, this foot valve will also work where the tubing is at an angle or in the horizontal position.

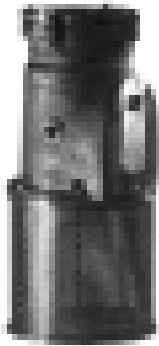

Part Number	Weight	OD Tubing Size
9-SFVV3.....	7.0 lbs.	3"
9-SFVV4.....	11.5 lbs.	4"
9-SFVV5.....	17.0 lbs.	5"
9-SFVV6.....	21.0 lbs.	6"
9-SFVV8.....	35.0 lbs.	8"
9-SFVV10	51.0 lbs.	10"
		12"*

* See 12" Vertical Companion Valve below

Aluminum Foot Valve with Vertical Companion Flange

This foot valve matches the bolt pattern of a standard 125 pound cast iron companion flange or a schedule 80 PVC flange. The hump on the body must face up when it is used in a horizontal or near horizontal position.

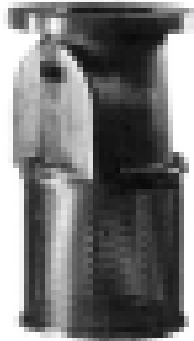

Part Number	Weight	Companion Flange Size
9-SFVV2-CF.....	6.0 lbs.	2"
9-SFVV3-CF.....	8.0 lbs.	3"
9-SFVV4-CF.....	14.5 lbs.	4"
9-SFVV5-CF.....	21.0 lbs.	5"
9-SFVV6-CF.....	25.0 lbs.	6"
9-SFVV8-CF.....	35.0 lbs.	8"
9-SFVV10-CF...	64.0 lbs.	10"
9-SFVV12-CF...	146.0 lbs.	12"

Aluminum Foot Valve with Vertical Female Thread

This aluminum foot valve is for use on hose, pipe or plastic pipe. The durable rubber flapper seats on a machined aluminum surface and provides a tight seal which minimizes leakage. Unlike the old fashioned leather flapper it does not dry out or shrink when out of service. Ample space is provided for the flapper to fold back out of the liquid stream thus keeping friction loss to a minimum. The hump on the body must face up when it is used in a horizontal or near horizontal position.

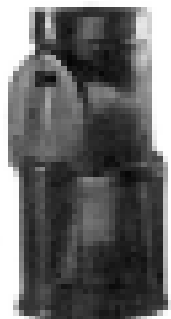

Part Number	Weight	Thread Size	Maximum Outside Dia.
9-SFVV2FP	4.0 lbs.	2"	5.75"
9-SFVV3FP	5.5 lbs.	3"	7.00"
9-SFVV4FP	10.0 lbs.	4"	7.75"
9-SFVV5FP	16.0 lbs.	5"	9.50"
9-SFVV6FP	19.0 lbs.	6"	11.00"
9-SFVV8FP	33.0 lbs.	8"	14.50"
9-SFVV10FP	51.0 lbs.	10"	17.00"

Product of: **TRAVIS PATTERN & FOUNDRY INC., SPOKANE, WASHINGTON**

Prices: SUBJECT TO CHANGE WITHOUT NOTICE

FAX: (509) 467-6465 - PHONE: (509) 466-3545

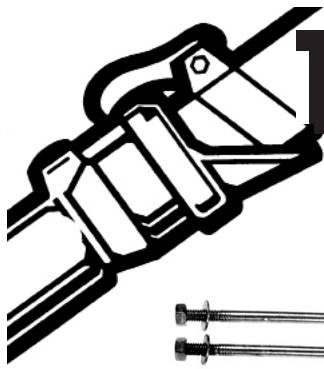

Parts for Cast Aluminum Coupling for Dresser Type Connections

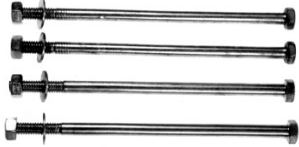

Bolt, Nut & Washer

Part Number

Flanges



- SFC-10F
- SFC-2F
- SFC-3F
- SFC-4F
- SFC-5F
- SFC-6F
- SFC-8F



Sleeve Casting

- SFC-10B
- SFC-2B
- SFC-3B
- SFC-4B
- SFC-5B
- SFC-6B
- SFC-8B



Ring Gasket

- SFC-10G
- SFC-2G
- SFC-3G
- SFC-4G
- SFC-5G
- SFC-6G
- SFC-8G

L-75 Sprinkler Leveler Parts

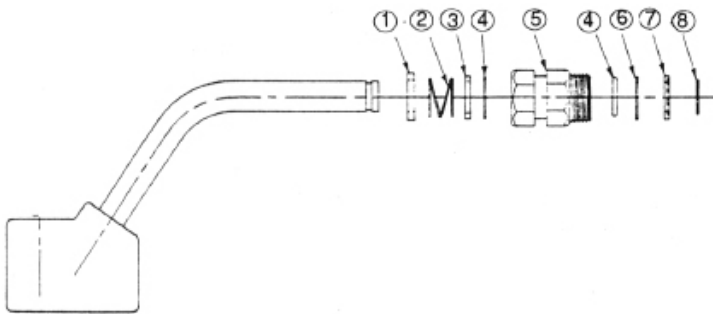

Part No.	Description	No.
659Repair Kit Consisting of following:	
653Spring Stop Washer.....	1
654Stainless Spring	2
655Rubber Washer	3
656Teflon Washer (2 req.).....	4
657Hex Bearing	5
659-8	..O-Ring.....	6
658Brass Retainer Washer...	7
659-10	Stainless Snap Ring.....	8

Product of: **TRAVIS PATTERN & FOUNDRY INC., SPOKANE, WASHINGTON**

Prices: SUBJECT TO CHANGE WITHOUT NOTICE

FAX: (509) 467-6465 - PHONE: (509) 466-3545



Stands for Giant Sprinklers

Tripod comes complete with riser, 2" female and 2 1/2" male threaded sprinkler adapter and 3" or 4" 90° inlet elbow.

<i>PART NO.</i>	<i>RISER LENGTH</i>	<i>DESCRIPTION</i>	<i>WT.</i>
17-3	30"	3" Inlet/Clamps 3" & 4" Dia. Mainline	21 lbs.
17-4	30"	4" Inlet/Clamps 3" & 4" Dia. Mainline	21 lbs.
17-5	30"	4" Inlet/Clamps 5" & 6" Dia. Mainline	21 lbs.

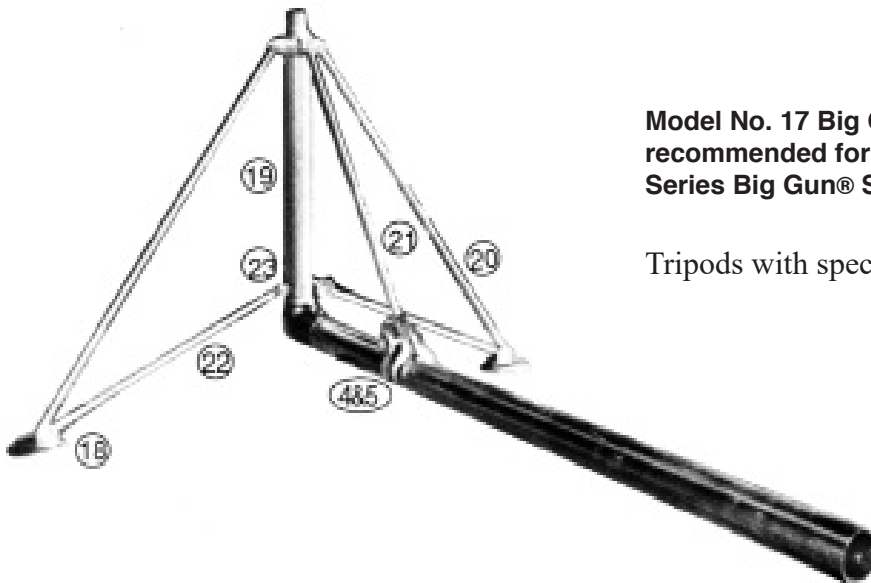

Model No. 17 Big Gun® Sprinkler Stand recommended for use with Nelson 100 Series Big Gun® Sprinkler or equivalent.

Tripods with special riser heights are available upon request.

17 Series Tripod Sprinkler Stands

Part Number	Description	Weight
15-5-4	Knob	0.5 lbs.
15-3-6 A&B	Pipe Clamp w/Bolt for 3" & 4" tubing	1.5 lbs.
15-5-6 A&B	Pipe Clamp w/Bolt for 5" & 6" tubing	1.6 lbs.
15-5-10	Set of 5 Nuts & Bolts for each Tripod	0.2 lbs.
16-5-0	Bolt Pack, includes 15-5-4 knob	
6057-4	Base Shoe	
6057-6	Riser Assembly for 17-3 (3" inlet)	
6057-20	Riser Assembly for 17-4 (4" inlet)	
6057-7	Upper Leg	
6057-8	Leg Brace	
6057-9	Lower Leg	
6081	Half Clamp	

Product of: **TRAVIS PATTERN & FOUNDRY INC., SPOKANE, WASHINGTON**

Prices: SUBJECT TO CHANGE WITHOUT NOTICE

FAX: (509) 467-6465 - PHONE: (509) 466-3545

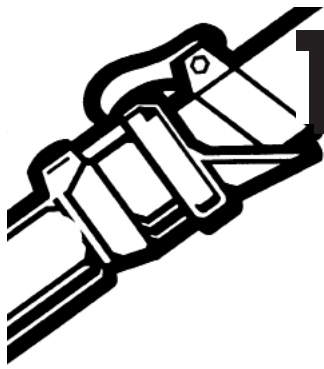

Wade / Western and A & M BIG GUN CART ASSEMBLY

84" long, 4" diameter axle and two heavy duty galvanized wheels. Clamp on 4" diameter aluminum riser includes a sprinkler adaptor for 2" male or 2 1/2" female sprinkler. Available in 3" or 4" male inlet. Each cart is shipped with both knob style and hook style latches. Optional Independent Bearing Kit allows each wheel to turn independently on axle for easier manual maneuvering in tight spaces.

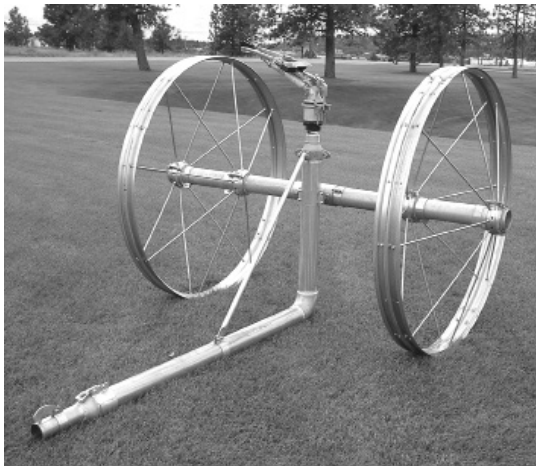

<i>PART No.</i>	<i>DESCRIPTION</i>	<i>WT.</i>
Low Profile 46" Wheel		
5046-3	3" male inlet w/46" wheels	107.0 lbs
5046-4	4" male inlet w/46" wheels	115.0 lbs
Standard Profile 57" Wheel		
5057-3	3" male inlet w/57" wheels	116.0 lbs
5057-4	4" male inlet w/57" wheels	116.0 lbs
Big Gun Cart Less Wheels		
5000-3	3" male inlet without wheels	39 lbs
5000-4	4" male inlet without wheels	39 lbs
5000	Optional Independent Bearing Kit	30 lbs

Big Gun® Cart Assembly recommended for use with Nelson 100 Series Big Gun® Sprinkler or equivalent.

5000 Series Big Gun Cart Components

Part Number	Description
13-4B	Clamp Bottom.....
6069-3	Center Tube (axle).....
6074-7	Center Journal.....
6100	Main Tube, 4" inlet.....
6103	Main Tube, 3" inlet.....
6101	Brace.....
70-4	Tail Wheel Clamp (6 required).....
8-4URNB	Ring set 4".....
8-3RNB	Ring set 3".....
8-10DX	Positive Latch (Knob Style).....
8-10G	Hook Style Latch.....

Product of: **TRAVIS PATTERN & FOUNDRY INC., SPOKANE, WASHINGTON**

Prices: SUBJECT TO CHANGE WITHOUT NOTICE

FAX: (509) 467-6465 - PHONE: (509) 466-3545

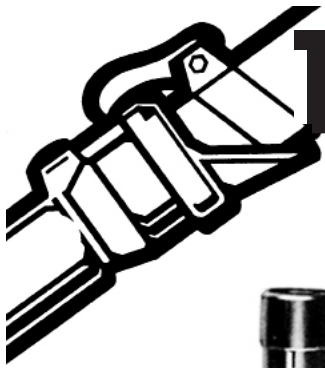

Aluminum Tubing Risers with Zamac Fittings



Part Number	Riser Length	Tubing Size	Fitting Size Male x Female	Weight	Pieces per Carton	
9-8-6A	6"	1"	1" x 3/4"	0.50 lbs.	100	\$ 6.84
9-8-12A	12"	1"	1" x 3/4"	0.60 lbs.	50	
9-8-18A	18"	1"	1" x 3/4"	0.70 lbs.	50	
9-8-24A	24"	1"	1" x 3/4"	0.80 lbs.	50	
9-8-30A	30"	1"	1" x 3/4"	0.92 lbs.	50	
9-8-36A	36"	1"	1" x 3/4"	1.05 lbs.	50	
9-8-48A	48"	1"	1" x 3/4"	1.30 lbs.	50	
9-8-60A	60"	1"	1" x 3/4"	1.52 lbs.	50	
9-8-72A	72"	1"	1" x 3/4"	1.65 lbs.	50	

Steel Tubing Risers with Zamac Fittings



Part Number	Riser Length	Tubing Size	Fitting Size Male x Female	Weight	Pieces per Carton	
9-4-6S	6"	3/4"	3/4" x 1/2"	0.5 lbs.	100	
9-4-12S	12"	3/4"	3/4" x 1/2"	0.7 lbs.	75	
9-4-18S	18"	3/4"	3/4" x 1/2"	1.0 lbs.	75	
9-4-24S	24"	3/4"	3/4" x 1/2"	1.2 lbs.	75	
9-6-6S	6"	3/4"	3/4" x 3/4"	0.5 lbs.	100	
9-6-12S	12"	3/4"	3/4" x 3/4"	0.7 lbs.	75	
9-6-18S	18"	3/4"	3/4" x 3/4"	1.0 lbs.	75	
9-6-24S	24"	3/4"	3/4" x 3/4"	1.2 lbs.	75	
9-8-6S	6"	1"	1" x 3/4"	0.62 lbs.	100	
9-8-12S	12"	1"	1" x 3/4"	0.88 lbs.	50	
9-8-18S	18"	1"	1" x 3/4"	1.10 lbs.	50	
9-8-24S	24"	1"	1" x 3/4"	1.40 lbs.	50	
9-8-30S	30"	1"	1" x 3/4"	1.60 lbs.	50	
9-8-36S	36"	1"	1" x 3/4"	1.90 lbs.	50	
9-8-48S	48"	1"	1" x 3/4"	2.40 lbs.	50	
9-8-60S	60"	1"	1" x 3/4"	2.90 lbs.	50	
9-8-72S	72"	1"	1" x 3/4"	3.40 lbs.	50	

Product of: **TRAVIS PATTERN & FOUNDRY INC., SPOKANE, WASHINGTON**

Prices: SUBJECT TO CHANGE WITHOUT NOTICE

FAX: (509) 467-6465 - PHONE: (509) 466-3545

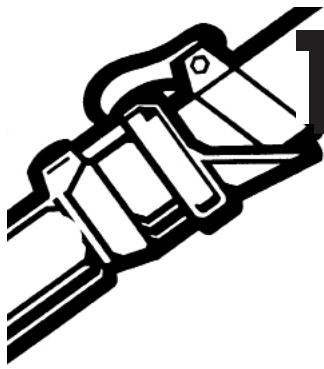

AIR RELIEF VALVES



SIZE	DESIGNATION	WT.
1"	AV 100	.20 lbs
1½"	AV 150	1.20
2"	AV 200	1.50
3"	AV 300	3.20
4"	AV 400	6.65

Contact Factory For
Quantity Prices

O RING	
SIZE	DESIGNATION
1½"	AV-OR 150
2"	AV-OR 200
3"	AV-OR 300

BALL	
DESIGNATION	
AV-B 150	
AV-B 200	
AV-B 300	

RETAINER	
DESIGNATION	
AV-BR 150	
AV-BR 200	
AV-BR 300	



ALUMINUM HOOK STYLE RISERS

Used to adapt various riser heights to Webstermatic style quick-coupling riser valves. Available in 1/2" tubing size and riser lengths of 6" through 72". Sprinkler connection is ACME thread for a Nelson Wind Fighter or 1/2" MIPT. Consult factory for pricing.



PRESSURE GAUGE (Air-filled)

- PSI 100.....
- PSI 200.....

Product of: **TRAVIS PATTERN & FOUNDRY INC., SPOKANE, WASHINGTON**

Prices: SUBJECT TO CHANGE WITHOUT NOTICE

FAX: (509) 467-6465 - PHONE: (509) 466-3545



UNIVERSAL PARTS

Continuous Acting Air & Vacuum Relief

Continuous Acting Air Vent and Vacuum Relief Valve provides large volume air release as line is filled and continually releases entrapped air during system operation as well as vacuum relief during line draining. Designed for lines pressures to 150 psi for 2" and 100 psi for 3" vents.



Part Number	Weight	Size	List Price Ea.
ARVC 200	6.0 lbs.	2"	
ARVC 300	9.7 lbs.	3"	
ARVC 400	10.65 lbs.	4"	

Large Orifice Discharge

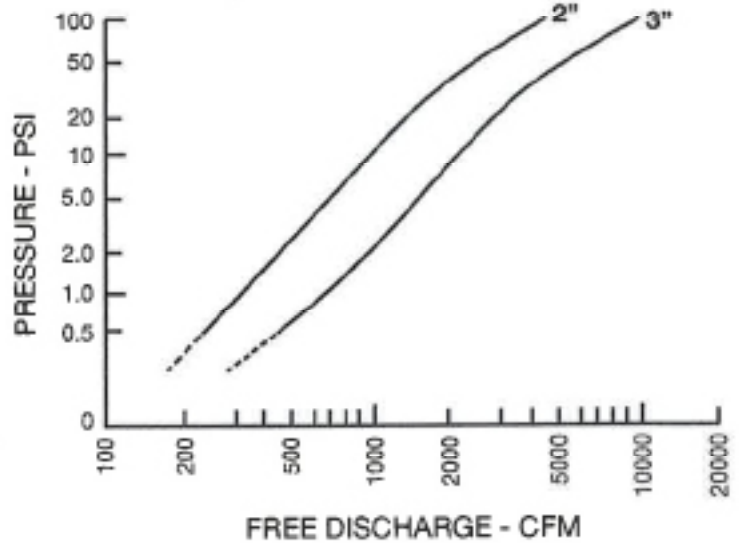

Small Orifice Discharge

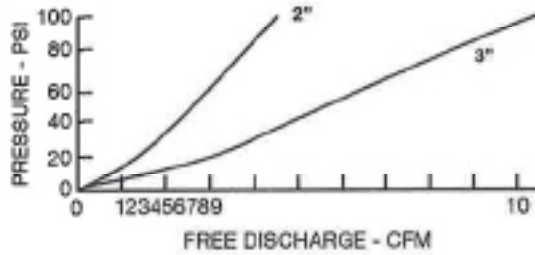

Large Orifice Intake

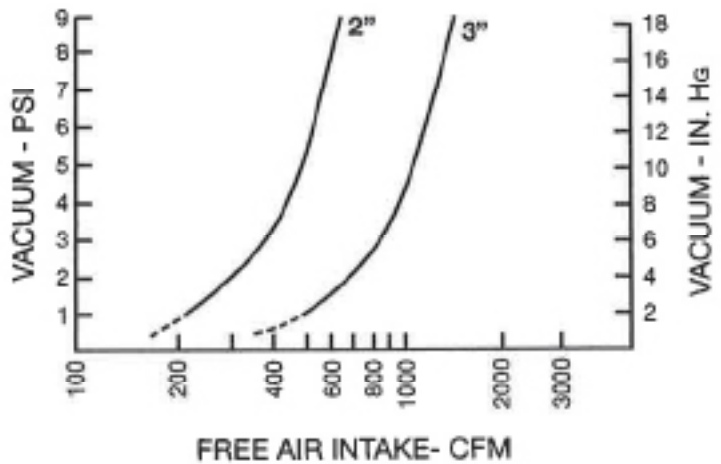

Product of: **TRAVIS PATTERN & FOUNDRY INC., SPOKANE, WASHINGTON**

Prices: SUBJECT TO CHANGE WITHOUT NOTICE

FAX: (509) 467-6465 - PHONE: (509) 466-3545

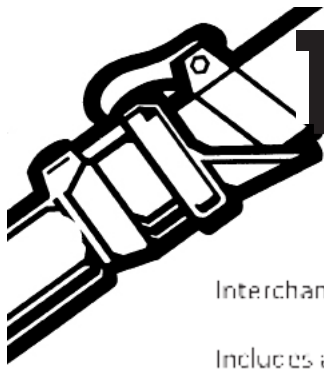

COMPACT ALUMINUM 4" X 3" BAND AND LATCH REDUCER

Interchangeable with most hook styles

Includes a standard Rainway 3" gasket

One piece design

Size	Designation	Wt.	Price
4" male x 3" female	RC 43	5 Lb.	



STEEL UNIVERSAL VALVE REPAIR ASSEMBLY

Used to keep a valve functioning and repaired at a later date.

<i>BODY SIZE</i>	<i>DESCRIPTION</i>
4" valve 6" deep punch	UVS SRV 400 (shown below)
4" valve 7.5" deep punch	UVS SRV 400 ED
6" valve 6" deep punch	UVS SRV 600
6" valve 8.75" deep punch	UVS SRV 600 ED

**Other sizes available - consult factory.*



Product of: **TRAVIS PATTERN & FOUNDRY INC., SPOKANE, WASHINGTON**

Prices: SUBJECT TO CHANGE WITHOUT NOTICE

FAX: (509) 467-6465 - PHONE: (509) 466-3545

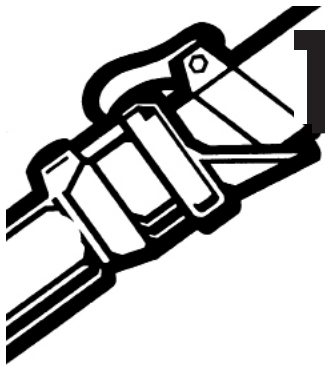

ZAMAC PIPE FITTINGS

Pipe Plugs



Part Number	Weight per Hundred	Size	
11500-1	5.8 lbs.	1/2"	\$
11500-2	7.4 lbs.	3/4"	
11500-3	12.4 lbs.	1"	
11500-4	21.2 lbs.	1-1/4"	

Bell Reducers

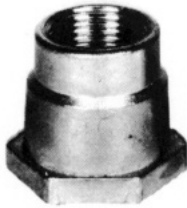

Part Number	Weight per Hundred	Size
11501-1	17.4 lbs.	3/4 x 1/2"
11501-2	22.0 lbs.	1" x 1/2"
11501-3	21.2 lbs.	1" x 3/4"
11501-4	41.0 lbs.	1-1/4" x 1"

Bushings



Part Number	Weight per Hundred	Size
11502-1	10.0 lbs.	3/4 x 1/2"
11502-2	21.6 lbs.	1" x 1/2"
11502-3	14.6 lbs.	1" x 3/4"
11502-4	25.0 lbs.	1-1/4" x 3/4"
11502-5	21.8 lbs.	1-1/4" x 1"

Couplings



Part Number	Weight per Hundred	Size
11503-1	11.0 lbs.	1/2"
11503-2	23.1 lbs.	3/4"
11503-4	21.4 lbs.	1"

Product of: **TRAVIS PATTERN & FOUNDRY INC., SPOKANE, WASHINGTON**

Prices: SUBJECT TO CHANGE WITHOUT NOTICE

FAX: (509) 467-6465 - PHONE: (509) 466-3545

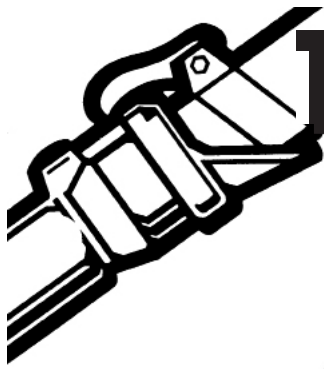

GROOVE FITTINGS



<i>TUBE SIZE</i>	<i>DESIGNATION</i>	<i>WT.</i>
6"	TR-VIC 600	2.0 lbs
8"	TR-VIC 800	2.5 lbs
10"	TR-VIC 1000	3.0 lbs
12"	TR-VIC-1200	4.5 lbs

GROOVE 90 DEGREE ELBOWS



<i>TUBE SIZE</i>	<i>DESIGNATION</i>	<i>WT.</i>
6"	TR-VIC-FE 600	12.0 lbs
8"	TR-VIC-FE 800	15.0 lbs
10"	TR-VIC-FE 1000	20.0 lbs
12"	TR-VIC-FE 1200	22.0 lbs

GROOVE 45 DEGREE ELBOWS



<i>TUBE SIZE</i>	<i>DESIGNATION</i>	<i>WT.</i>
6"	TR-VIC-FE 600-45	10.0 lbs
8"	TR-VIC-FE 800-45	12.5 lbs
10"	TR-VIC-FE 1000-45	17.0 lbs
12"	TR-VIC-FE 1200-45	19.0 lbs

22.5' and 11.25' elbows available for the same price as 45'

Product of: **TRAVIS PATTERN & FOUNDRY INC., SPOKANE, WASHINGTON**

Prices: SUBJECT TO CHANGE WITHOUT NOTICE

FAX: (509) 467-6465 - PHONE: (509) 466-3545



GROOVE TEES



<i>TUBE SIZE</i>	<i>DESIGNATION</i>	<i>WT.</i>
6"	TR-VIC-FT 600	8.0 lbs
8"	TR-VIC-FT 800	10.0 lbs
10"	TR-VIC-FT 1000	15.0 lbs

GROOVE REDUCERS



<i>TUBE SIZE</i>	<i>DESIGNATION</i>	<i>WT.</i>
6" X 8"	TR-VIC-R 68	10.0 lbs
8" X 10"	TR-VIC-R 810	12.0 lbs
6" X 10"	TR-VIC-R 610	13.0 lbs
8" X 12"	TR-VIC-R 812	17.00 lbs
10" X 12"	TR-VIC-R1012	14.50 lbs

Custom fabricated fittings available. Please call factory for information.

Product of: **TRAVIS PATTERN & FOUNDRY INC., SPOKANE, WASHINGTON**

Prices: SUBJECT TO CHANGE WITHOUT NOTICE

FAX: (509) 467-6465 - PHONE: (509) 466-3545

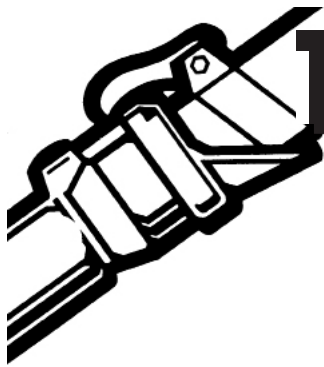

PIVOT ACCESSORIES



PIVOT BOOT

<i>PART NO.</i>	<i>DESCRIPTION</i>	<i>WT.</i>
PB-16	6 ⁵ / ₈ x 16" Boot-Heavy Duty Nitrile Rubber w/Polyester Braid	3.50 lbs
PBC	Clamp for above-Stainless Steel	.50

BOLT ON ADJUSTABLE MALE END



<i>SIZE</i>	<i>DESIGNATION</i>	<i>WT.</i>
6"	SRLMBO 600	2.70 lbs
8"	SRLMBO 800	4.60
10"	SRLMBO 1000	5.80

Product of: **TRAVIS PATTERN & FOUNDRY INC., SPOKANE, WASHINGTON**

Prices: SUBJECT TO CHANGE WITHOUT NOTICE

FAX: (509) 467-6465 - PHONE: (509) 466-3545

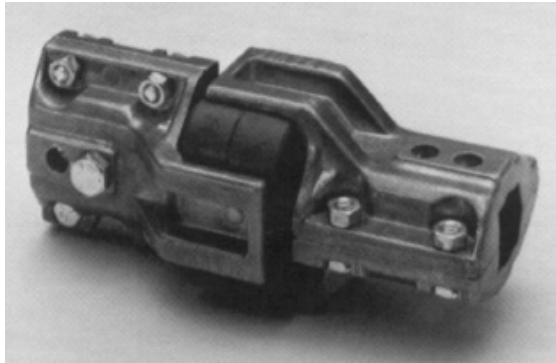
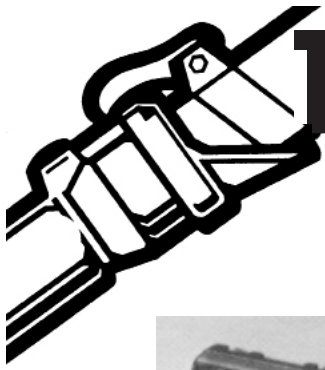

U-JOINT DRIVELINE COUPLER ASSEMBLIES*

*Includes 4 arm 1/2s, rubber puck insert and nut & bolt package

SETS

<i>PART NO.</i>	<i>DESCRIPTION</i>	<i>WT.</i>
DCA 1/8 x 1s	1/8" Round to 1" Square Shaft	2.50 lbs
DCA 1 x 7/8s	1" Round to 7/8" Square Shaft	2.50
DCA 1 x 3/4s	1" Round to 3/4" Square Shaft	2.50
DCA 1 kw x 3/4s	1" Round w/Keyway to 3/4" Square Shaft	2.50

INDIVIDUAL PARTS

DCA-1	Arm 1/2 for 1" Round or 7/8" Square Shaft	.40
DCA-1kw	Arm 1/2 for 1" Round w/Keyway	.40
DCA-1s	Arm 1/2 for 1 1/8" Round or 1" Square Shaft	.40
DCA-3/4s	Arm 1/2 for 3/4" Square Shaft	.40
(DCA-7/8s - Same as DCA-1)		
DCA-RP	Rubber Puck Insert	.50
DCA-NB	Nut & Bolt Package	.10

Product of: **TRAVIS PATTERN & FOUNDRY INC., SPOKANE, WASHINGTON**

Prices: SUBJECT TO CHANGE WITHOUT NOTICE

FAX: (509) 467-6465 - PHONE: (509) 466-3545

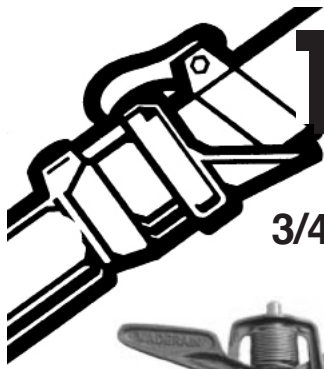

3/4" BRASS AGRICULTURAL SPRINKLERS



WR-33



WR-32



WR-35

NOTE: All sprinklers are double nozzle, but are shipped with the removable spreader nozzle plug installed and no range nozzle. All nozzles are ordered separately.

**See performance data on following pages.*

Part Number	Description	Weight	Pieces Per Box
WR-33	Brass Impact Sprinkler	1.0 lb	30/60
WR-32	Brass Sprinkler w/Aluminum Arm	1.0 lb	30/60
WR-35	Part-circle Adjustable Brass Sprinkler	1.4 lb	20

NOZZLES

Part Number	Description	GPM at 50 PSI	Application Rate (40 x 60)	Pieces Per Box
WR-7/64	7/64" Range Nozzle	2.45		30
WR-1/8	1/8" Range Nozzle	3.22		30
WR-9/64	9/64" Range Nozzle	4.07	.16"/hr	30
WR-5/32	5/32" Range Nozzle	4.98	.20"/hr	30
WR-11/64	11/64" Range Nozzle	6.01	.24"/hr	30
WR-3/16	3/16" Range Nozzle	7.16	.29"/hr	30
WR-13/64	13/64" Range Nozzle	8.45	.34"/hr	30
WR-7/32	7/32" Range Nozzle	9.90	.40"/hr	30
WR-1/4	1/4" Range Nozzle	12.80	.52"/hr	30
SSN-3/32	3/32" Spreader Nozzle	3.22		30
SSN-1/8	1/8" Spreader Nozzle	1.76		30
SNP	Spreader Nozzle Plug (included with sprinkler)			50
VANE	Stream Straightening Vane for Range Nozzle			100

Product of: **TRAVIS PATTERN & FOUNDRY INC., SPOKANE, WASHINGTON**

Prices: SUBJECT TO CHANGE WITHOUT NOTICE

FAX: (509) 467-6465 - PHONE: (509) 466-3545



TRAVIS

UNIVERSAL PARTS

PERFORMANCE DATA



WR-33 BRASS IMPACT SPRINKLER

WR-33 SINGLE NOZZLE - 27 DEG. TRAJECTORY (NO VANE)

NOZ PSI	1/8"		9/64"		5/32"		11/64"		3/16"		13/64"		7/32"	
	GPM	DIA. FT.	GPM	DIA. FT.	GPM	DIA. FT.	GPM	DIA. FT.	GPM	DIA. FT.	GPM	DIA. FT.	GPM	DIA. FT.
25	—	—	2.88	80	3.52	82	4.24	83	5.0	85	5.90	86	6.85	88
30	—	—	3.15	81	3.85	85	4.64	88	5.5	91	6.50	94	7.55	96
35	—	—	3.40	82	4.16	87	5.02	90	6.0	94	7.05	97	8.20	100
40	—	—	3.64	83	4.45	88	5.37	92	6.4	96	7.55	99	8.80	102
45	3.05	82	3.86	84	4.72	89	5.70	94	6.8	98	8.00	101	9.35	104
50	3.22	83	4.07	85	4.98	90	6.01	95	7.2	100	8.45	103	9.90	106
55	3.38	84	4.27	86	5.22	91	6.30	96	7.5	101	8.85	104	10.40	107
60	3.53	85	4.46	87	5.45	92	6.57	97	7.9	102	9.25	105	10.75	108
65	3.68	86	4.65	88	5.68	93	6.83	98	8.2	103	9.60	106	11.10	109
70	3.82	86	4.83	89	5.90	94	7.09	99	8.5	104	9.95	107	11.40	110
75	3.96	87	5.00	90	6.11	95	7.34	100	8.8	105	10.25	108	11.70	111
80	4.09	87	5.17	91	6.30	96	7.58	101	9.1	106	10.50	109	12.00	112

WR-33 DOUBLE NOZZLE - 27 DEG. TRAJECTORY (NO VANE)

NOZ PSI	9/64"x 3/32"		5/32"x 3/32"		11/64"x 3/32"		3/16"x 3/32"		3/16"x 1/8"		13/64"x 1/8"		7/32"x 1/8"	
	GPM	DIA. FT.	GPM	DIA. FT.	GPM	DIA. FT.	GPM	DIA. FT.	GPM	DIA. FT.	GPM	DIA. FT.	GPM	DIA. FT.
25	4.18	80	4.83	82	5.55	83	6.31	85	7.40	85	8.30	86	9.25	88
30	4.58	81	5.28	85	6.07	88	6.93	91	8.15	91	9.15	94	10.20	96
35	4.95	82	5.71	87	6.57	90	7.51	94	8.83	94	9.93	97	11.10	100
40	5.29	83	6.11	88	7.03	92	8.03	96	9.46	96	10.65	99	11.90	102
45	5.61	84	6.48	89	7.46	94	8.53	98	10.05	98	11.30	101	12.65	104
50	5.91	85	6.82	90	7.87	95	9.00	100	10.60	100	11.90	103	13.35	106
55	6.20	86	7.15	91	8.25	96	9.45	101	11.10	101	12.50	104	14.00	107
60	6.48	87	7.47	92	8.60	97	9.86	102	11.60	102	13.00	105	14.50	108
65	6.75	88	7.78	93	8.93	98	10.27	103	12.10	103	13.50	106	15.00	109
70	7.00	89	8.08	94	9.25	99	10.66	104	12.50	104	14.00	107	15.45	110
75	7.25	90	8.37	95	9.56	100	11.02	105	12.90	105	14.40	108	15.90	111
80	7.49	91	8.65	96	9.87	101	11.36	106	13.25	106	14.80	109	16.30	112

NOTE:

- * Optional straightening vane will increase diameters by 4-8% at pressures of 40 psi and above.
- * Highest point of stream is 8 ft. above nozzle with 1/8" nozzle at normal operating pressure.
- * Performance stated at base pressure.

Product of: **TRAVIS PATTERN & FOUNDRY INC., SPOKANE, WASHINGTON**

Prices: SUBJECT TO CHANGE WITHOUT NOTICE

FAX: (509) 467-6465 - PHONE: (509) 466-3545



PERFORMANCE DATA

WR-32 BRASS IMPACT SPRINKLER

ALUMINUM ARM FOR LOW GALLONAGE APPLICATIONS

WR-32 SINGLE NOZZLE - ALUMINUM ARM

NOZ PSI	7/64"		1/8"		9/64"	
	GPM	DIA. FT.	GPM	DIA. FT.	GPM	DIA. FT.
25	1.73	77	2.25	78	2.88	80
30	1.89	78	2.47	79	3.15	81
35	2.05	78	2.68	80	3.40	82
40	2.19	79	2.87	81	3.64	83
45	2.32	80	3.05	82	3.86	84
50	2.45	80	3.22	83	4.07	85
55	2.57	81	3.38	84	4.27	86
60	2.68	82	3.53	85	4.46	87
65	2.79	82	3.68	86	4.65	88
70	2.90	83	3.82	86	4.83	89
75	3.00	83	3.96	87	5.00	90
80	3.10	84	4.09	87	5.17	91

WR-32 SINGLE NOZZLE - ALUMINUM ARM WITH STRAIGHTENING VANE

NOZ PSI	7/64"		1/8"		9/64"	
	GPM	DIA. FT.	GPM	DIA. FT.	GPM	DIA. FT.
25	1.73	78	2.25	82	2.88	85
30	1.89	79	2.47	84	3.15	87
35	2.05	80	2.68	85	3.40	89
40	2.19	81	2.87	86	3.64	91
45	2.32	82	3.05	87	3.86	92
50	2.45	83	3.22	88	4.07	93
55	2.57	84	3.38	89	4.27	94
60	2.68	85	3.53	90	4.46	95
65	2.79	86	3.68	91	4.65	96
70	2.90	87	3.82	92	4.83	97
75	3.00	88	3.96	93	5.00	98
80	3.10	89	4.09	94	5.17	100

Product of: **TRAVIS PATTERN & FOUNDRY INC., SPOKANE, WASHINGTON**

Prices: SUBJECT TO CHANGE WITHOUT NOTICE

FAX: (509) 467-6465 - PHONE: (509) 466-3545



WR-35 ADJUSTABLE PART-CIRCLE BRASS IMPACT SPRINKLER

WR-35 SINGLE NOZZLE - 25 DEG. TRAJECTORY (NO VANE)

NOZ PSI	5/32"		11/64"		3/16"		13/64"		7/32"	
	GPM	DIA. FT.	GPM	DIA. FT.	GPM	DIA. FT.	GPM	DIA. FT.	GPM	DIA. FT.
30	3.85	84	4.64	87	5.5	89	6.50	96	7.55	94
35	4.16	85	5.02	88	5.96	92	7.05	95	8.20	96
40	4.45	87	5.37	90	6.38	94	7.55	97	8.80	98
45	4.72	88	5.70	92	6.78	96	8.00	99	9.35	100
50	4.98	89	6.01	93	7.16	98	8.45	101	9.90	102
55	5.22	90	6.30	94	7.52	100	8.85	102	10.40	104
60	5.45	91	6.57	96	7.85	101	9.25	103	10.75	105
65	5.68	92	6.83	97	8.18	102	9.60	104	11.10	106
70	5.90	93	7.09	98	8.50	103	9.95	105	11.40	107

WR-35 DOUBLE NOZZLE - 25 DEG. TRAJECTORY (NO VANE)

NOZ PSI	9/64"x 3/32"		5/32"x 3/32"		11/64"x 3/32"		3/16"x 3/32"		3/16"x 1/8"		13/64"x 1/8"		7/32"x 1/8"	
	GPM	DIA. FT.	GPM	DIA. FT.	GPM	DIA. FT.	GPM	DIA. FT.	GPM	DIA. FT.	GPM	DIA. FT.	GPM	DIA. FT.
30	4.58	80	5.28	84	6.07	87	6.93	89	8.15	89	9.15	93	10.20	94
35	4.95	81	5.71	85	6.57	88	7.51	92	8.83	92	9.93	95	11.10	96
40	5.29	82	6.11	87	7.03	90	8.03	94	9.46	94	10.65	97	11.90	98
45	5.61	83	6.48	88	7.46	92	8.53	96	10.05	96	11.30	99	12.65	100
50	5.91	84	6.82	89	7.87	93	9.00	98	10.60	98	11.90	101	13.35	102
55	6.20	85	7.15	90	8.25	94	9.45	100	11.10	100	12.50	102	14.00	104
60	6.48	86	7.47	91	8.60	96	9.86	101	11.60	101	13.00	103	14.50	105
65	6.75	87	7.78	92	8.93	97	10.27	102	12.10	102	13.50	104	15.00	106
70	7.00	88	8.08	93	9.25	98	10.66	103	12.50	103	14.00	105	15.45	107

NOTE:

- * Optional straightening vane will increase diameters by 4-8% at pressures of 40 psi and above.
- * Highest point of stream is 7 ft. above nozzle with 1/8" nozzle at normal operating pressure.
- * Performance stated at base pressure.

Product of: **TRAVIS PATTERN & FOUNDRY INC., SPOKANE, WASHINGTON**

Prices: SUBJECT TO CHANGE WITHOUT NOTICE

FAX: (509) 467-6465 - PHONE: (509) 466-3545



SPRINKLER PARTS

WR-33 & WR-32

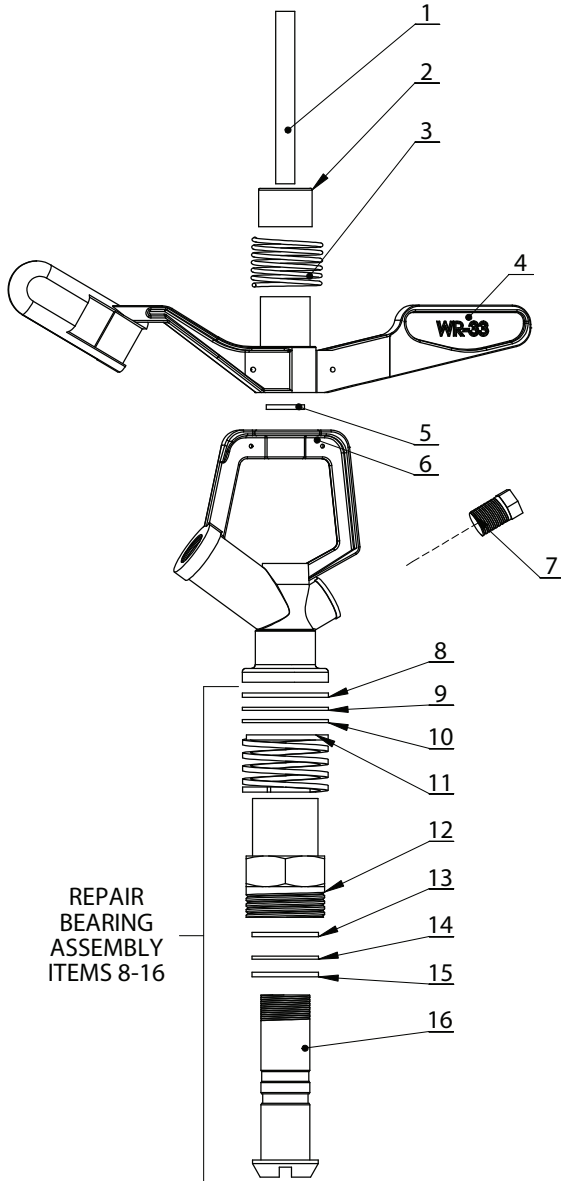

REPAIR BEARING ASSEMBLY ITEMS 8-16

(1) Available only in WR-RBA-kit

(2) Available only in WR-RBA-32 kit only

	Date Stamp	Arm Length
Old Design	Prior 0711	6-9/16"
New Design	0811 and up	6-7/8"

* For Date Stamp prior to 0711. Date Stamp on hex face of Sleeve Bearing indicates Month/Year of manufacture.

WR-33 Parts – Prior to 0711

Item	Part Number	Description
1	WR-PIN-33	Fulcrum Pin
2	WR-ARMHOOD	Arm Hood
3	WR-ARMSPR-33	Arm Spring
4	WR-ARM-33	Arm, bronze
5	WR-ARMWASHER	Arm Spacer Washer
6	N/A	Body
7	SNP	Secondary nozzle plug
8	WR-USW	Upper Seal Washer, black
9	WR-UBW	Upper Bearing Washer, grey
10	WR-BRW	Upper Brass Washer
11	(1)	Bearing Spring
12	(1)	Sleeve Bearing
13	WR-TSW	Top Seal Washer, blk, 17.81 ID
14	WR-BBW	Bottom Bearing Washer, Grey
15	WR-LSW	Lower Seal Washer, 17.0 ID
16	(1)	Nipple Bearing
Kit 8-16	WR-RBA	Repair Bearing Assembly

WR-32 (Aluminum Arm) Parts – Prior to 0711

Item	Part Number	Description
1	WR-PIN-32	Fulcrum Pin
2	WR-ARMHOOD	Arm Hood
3	WR-ARMSPR-33	Arm Spring
4	WR-ARM-32	Arm, aluminum
5	WR-ARMWASH-32/35	Arm Spacer Washer
6	N/A	Body
7	SNP	Secondary nozzle plug
8	WR-USW	Upper Seal Washer, black
9	(2)	Upper Bearing Washer, white
10	WR-BRW	Upper Brass Washer
11	(2)	Bearing Spring
12	(2)	Sleeve Bearing
13	WR-TSW	Top Seal Washer, blk, 17.81 ID
14	WR-BBW-32	Bottom Bearing Washer, Teflon
15	WR-LSW	Lower Seal Washer, 17.0 ID
16	(2)	Nipple Bearing
Kit 8-16	WR-RBA-32	Repair Bearing Assembly

Product of: **TRAVIS PATTERN & FOUNDRY INC., SPOKANE, WASHINGTON**

Prices: SUBJECT TO CHANGE WITHOUT NOTICE

FAX: (509) 467-6465 - PHONE: (509) 466-3545



SPRINKLER PARTS

WR-33 & WR 32

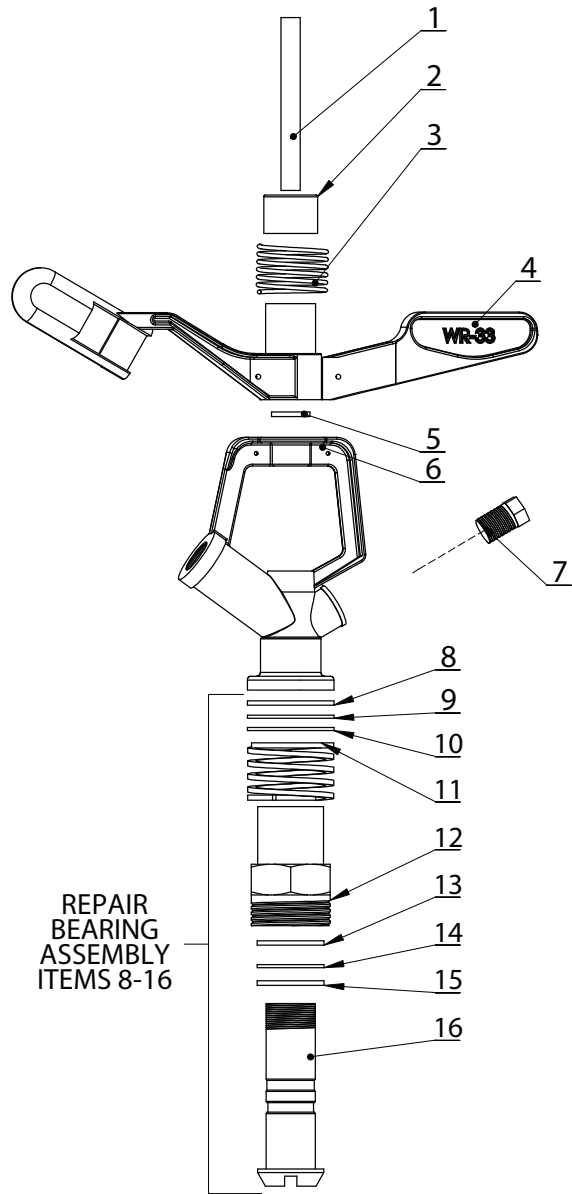

- (1) Available only in WR-RBA- - 0811 kit
- (2) Available only in WR-RBA- - 0811 kit only

	Date Stamp	Arm Length
Old Design	Prior 0711	6-9/16"
New Design	0811 and up	6-7/8"

* For Date Stamp 0811 & newer. Date Stamp on hex face of Sleeve Bearing indicates Month/Year on manufacture.

WR-33 Parts — 0811 and newer

Item	Part Number	Description
1	WR-PIN-33	Fulcrum Pin
2	WR-ARMHOOD	Arm Hood
3	WR-ARMSPR-33	Arm Spring
4	WR-ARM - 0811	Arm, bronze
5	WR-ARMWASHER	Arm Spacer Washer
6	N/A	Body
7	SNP	Secondary nozzle plug
8	WR-USW - 0811	Upper Seal Washer, black
9	WR-UBW - 0811	Upper Bearing Washer, grey
10	WR-BRW - 0811	Upper Brass Washer
11	(1)	Bearing Spring
12	(1)	Sleeve Bearing
13	WR-TSW - 0811	Top Seal Washer, blk, 17.81 ID
14	WR-BBW - 0811	Bottom Bearing Washer, Grey
15	WR-LSW	Lower Seal Washer, 17.0 ID
16	(1)	Nipple Bearing
Kit 8-16	WR-RBA - 0811	Repair Bearing Assembly

WR-32 (Aluminum Arm) Parts — 0811 and newer

Item	Part Number	Description
1	WR-PIN-32	Fulcrum Pin
2	WR-ARMHOOD	Arm Hood
3	WR-ARMSPR-33	Arm Spring
4	WR-ARM-32 - 0811	Arm, aluminum
5	WR-ARMWASH-32/35	Arm Spacer Washer
6	N/A	Body
7	SNP	Secondary nozzle plug
8	WR-USW - 0811	Upper Seal Washer, black
9	(2)	Upper Bearing Washer, white
10	WR-BRW - 0811	Upper Brass Washer
11	(2)	Bearing Spring
12	(2)	Sleeve Bearing
13	WR-TSW - 0811	Top Seal Washer, blk, 17.81 ID
14	WR-BBW-32	Bottom Bearing Washer, Teflon
15	WR-LSW	Lower Seal Washer, 17.0 ID
16	(2)	Nipple Bearing
Kit 8-16	WR-RBA-32 - 0811	Repair Bearing Assembly

Product of: **TRAVIS PATTERN & FOUNDRY INC., SPOKANE, WASHINGTON**

Prices: SUBJECT TO CHANGE WITHOUT NOTICE

FAX: (509) 467-6465 - PHONE: (509) 466-3545

SPRINKLER PARTS

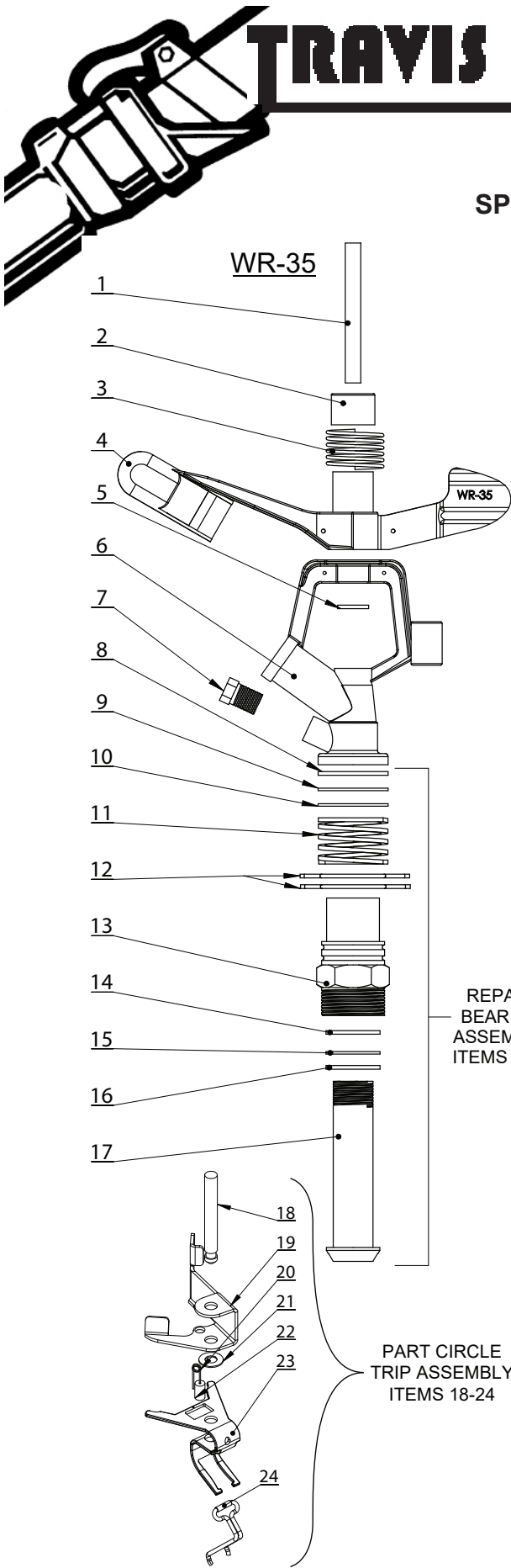

WR-35 (Part Circle) Parts

Item	Part Number	Description
1	N/A	Fulcrum Pin
2	N/A	Arm Hood
3	WR-ARMSPR-33	Arm Spring
4	WR-ARM-35	Arm, WR-35
5	WR-ARMWASH-32/35	Arm Spacer Washer
6	N/A	Body
7	SNP	Secondary Nozzle Plug
8	(1)	Upper Seal Washer, black
9	(1)	Upper Bearing Washer, white
10	(1)	Upper Brass Washer
11	(1)	Bearing Spring
12	WR-STOP-35	Part-Circle Stop Collar
13	(1)	Sleeve Bearing
14	WR-TSW	Top Seal Washer, blk, 17.81 ID
15	WR-BBW-35	Bottom Bearing Washer, White
16	WR-LSW-35	Lower Seal Washer
17	(1)	Nipple Bearing
Kit 8-17. WR-RBA-35		Repair Bearing Assembly
18	(2)	Trip Pin
19	(2)	Upper Trip Bracket
20	(2)	Trip Spring
21	(2)	Washer & Clip, Trip Mechanism
22	(2)	Trip Spring Barrel
23	(2)	Lower Trip Bracket
24	WR-CLIP-35	PC Flip Clip w/ Retainer Barrel
25	WR-PCTRIPASSY-35	Part Circle Trip Assembly

(1) Available in WR-RBA-35 - kit only

(2) Available in WR-PCTRIPASSY-35 - kit only

Product of: **TRAVIS PATTERN & FOUNDRY INC., SPOKANE, WASHINGTON**

Prices: SUBJECT TO CHANGE WITHOUT NOTICE

FAX: (509) 467-6465 - PHONE: (509) 466-3545



TRAVIS

UNIVERSAL PARTS



2208-1

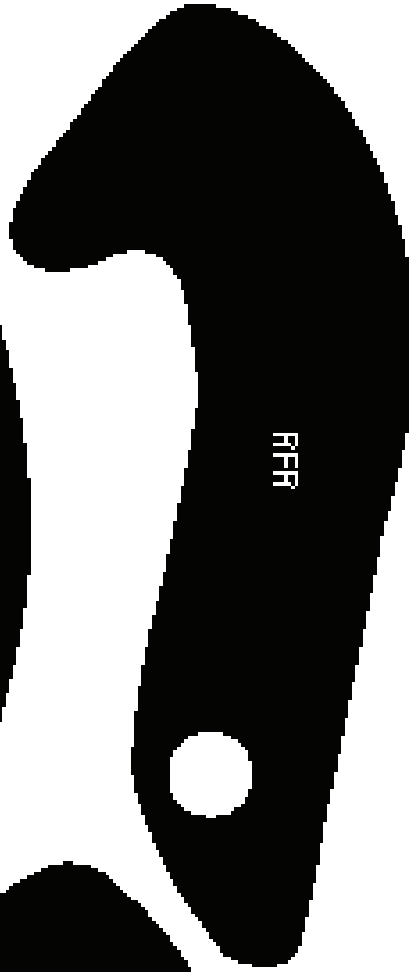

RFR

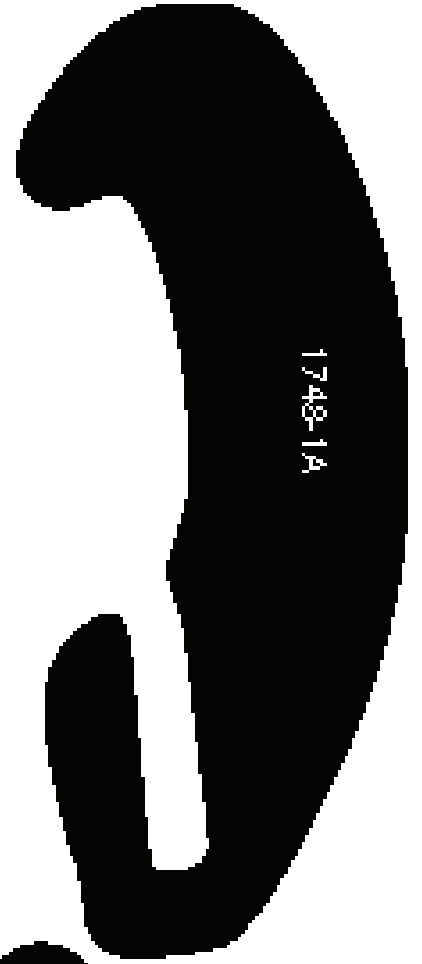

1748-1A

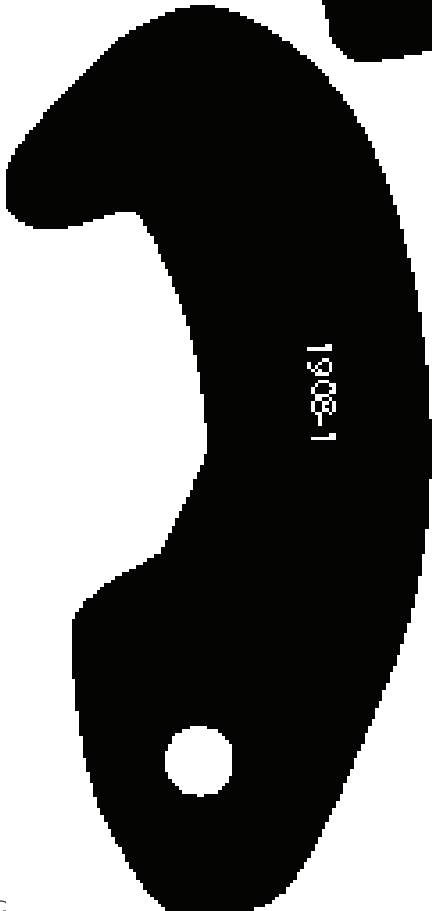

1908-1

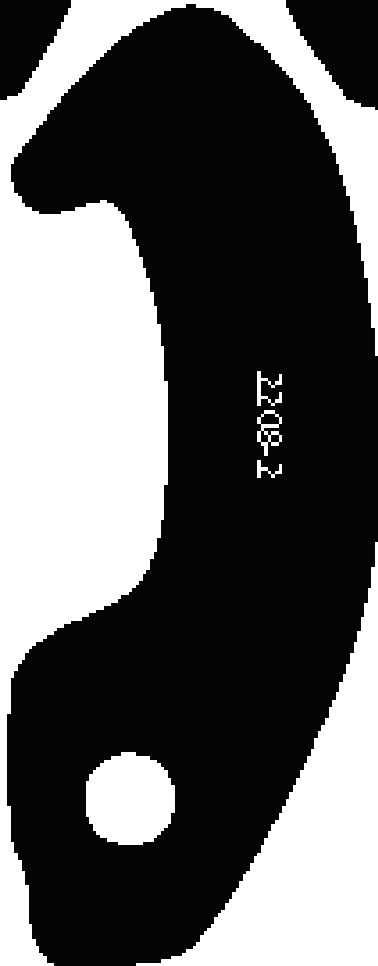

2208-2

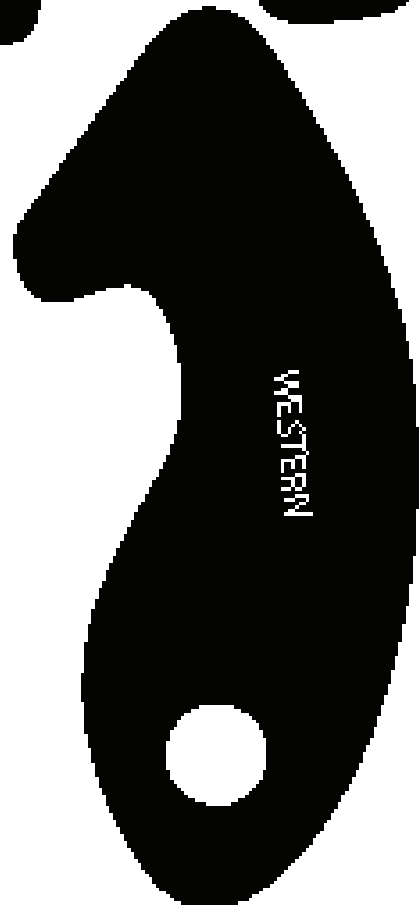

WESTERN

