

RU101 SHOWN

GENERAL DESCRIPTION:

Valve body features cast brass construction with a pre-installed test cap. Features back-to-back capability. One-half inch inlets and outlets (choice of Universal, PEX Crimp, PEX Cold Expansion, CPVC or Stub-outs). Features test cap with stainless steel retaining ring with flats. Available with screwdriver stops. Rough-in plaster guard designed as rough-in guide and for use as thin wall mounting support. For use with TU series trim kits with cartridges.

PRODUCT FEATURES:

Choice of Connections: Fast and easy installation without adaptors reducing leak points. Available connections include Universal (male thread/female sweat), PEX Crimp, PEX Cold expansion, CPVC, and Stub-outs.

Cast Brass Valve Body: Durable. Ideal material for prolonged contact with water.

Flat Back: Allows valve to be mounted flush against cross brace for easy and solid installation.

Test Cap: Allows valve body to be tested and flushed without the presence of the valve cartridge. Can be tested using test cap with air (200 psi) or water (300 psi).

Stainless Steel Retaining Ring with Flats: Secures test cap/cartridge in place and eliminates need for screws. Flats make it simple to loosen ring for quick, easy insertion/removal of test cap/cartridge.

Back-to-Back Capability: Hot and cold can be reversed quickly and easily.

Exclusive Plaster Guard: Plaster guard is designed to protect valve and act as a guide during installation. It can serve as mounting support for thin-wall installations.

Wide Rough-in Range: From 1-3/4" to 2-3/4" from finished wall to the back of the valve.

MODEL NUMBERS:

- RU101 Flash Rough Valve Body with Flash Connections**
1/2" Universal inlets/outlets.
- RU101SS Flash Rough Valve Body with Flash Connections with Screwdriver Stops**
1/2" Universal inlets/outlets.
- RU102 Flash Rough Valve Body with Stub-Out Connections**
1/2" Stub-out inlets/outlets.
- RU102SS Flash Rough Valve Body with Stub-Out Connections with Screwdriver Stops**
1/2" Stub-out inlets/outlets.
- RU107 Flash Rough Valve Body with PEX Crimp Connections**
1/2" PEX Crimp inlets (ASTM F1807) / Universal outlets.
- RU107SS Flash Rough Valve Body with PEX Crimp Connections with Screwdriver Stops**
1/2" PEX Crimp inlets (ASTM F1807) / Universal outlets.
- RU107E Flash Rough Valve Body with PEX Crimp Elbow Connections**
1/2" PEX Crimp Elbow inlets (ASTM F1807) / Universal outlets.
- RU107ESS Flash Rough Valve Body with PEX Crimp Elbow Connections with Screwdriver Stops**
1/2" PEX Crimp Elbow inlets (ASTM F1807) / Universal outlets.
- RU108 Flash Rough Valve Body with PEX Cold Expansion Connections**
1/2" PEX Cold Expansion inlets (ASTM F1960) / Universal outlets.
- RU108SS Flash Rough Valve Body with PEX Cold Expansion Connections with Screwdriver Stops**
1/2" PEX Cold Expansion inlets (ASTM F1960) / Universal outlets.
- RU108E Flash Rough Valve Body with PEX Cold Expansion Elbow Connections**
1/2" PEX Cold Expansion Elbow inlets (ASTM F1960) / Universal outlets.
- RU108ESS Flash Rough Valve Body with PEX Cold Expansion Elbow Connections with Screwdriver Stops**
1/2" PEX Cold Expansion Elbow inlets (ASTM F1960) / Universal outlets.
- RU109 Flash Rough Valve Body with CPVC Connections**
1/2" CPVC inlets / Universal outlets.
- RU1098SS Flash Rough Valve Body with CPVC Connections with Screwdriver Stops**
1/2" CPVC inlets / Universal outlets.

SUGGESTED SPECIFICATION

Rough Valve Body shall feature a cast brass body. Shall feature back-to-back capability. Valve Body shall feature test cap to flush and test the lines. Shall feature stainless steel retaining ring with flats. Rough Valve Body shall be: Rough Valve Body - American Standard Model # RU10____.

UNIVERSAL	
<p>RU101</p> <p>INLETS ½" NOM. COPPER SWEAT or ½" MALE NPT</p> <p>OUTLETS ½" NOM. COPPER SWEAT or ½" MALE NPT</p>	<p>RU101SS</p> <p>INLETS ½" NOM. COPPER SWEAT or ½" MALE NPT</p> <p>OUTLETS ½" NOM. COPPER SWEAT or ½" MALE NPT</p>
STUB-OUT FOR PRESS-CONNECT FITTINGS	
<p>RU102</p> <p>INLETS ½" STUB OUT</p> <p>OUTLETS ½" STUB OUT</p>	<p>RU102SS</p> <p>INLETS ½" STUB OUT</p> <p>OUTLETS ½" STUB OUT</p>
PEX-CRIMP	
<p>RU107</p> <p>INLETS ½" PEX (ASTM F1807-2)</p> <p>OUTLETS ½" NOM. COPPER SWEAT or ½" MALE NPT</p>	<p>RU107SS</p> <p>INLETS SWEAT or ½" PEX (ASTM F1807-2)</p> <p>OUTLETS ½" NOM. COPPER SWEAT or ½" MALE NPT</p>
<p>RU107E</p> <p>INLETS ½" PEX (ASTM F1960)</p> <p>OUTLETS ½" NOM. COPPER SWEAT or ½" MALE NPT</p> <p><i>Valve can be rotated 180° for ceiling mount supply lines</i></p>	<p>RU107ESS</p> <p>INLETS ½" PEX (ASTM F1960)</p> <p>OUTLETS ½" NOM. COPPER SWEAT or ½" MALE NPT</p> <p><i>Valve can be rotated 180° for ceiling mount supply lines</i></p>
PEX-COLD EXPANSION	
<p>RU108</p> <p>INLETS ½" PEX (ASTM F1960)</p> <p>OUTLETS ½" NOM. COPPER SWEAT or ½" MALE NPT</p>	<p>RU108SS</p> <p>INLETS ½" PEX (ASTM F1960)</p> <p>OUTLETS ½" NOM. COPPER SWEAT or ½" MALE NPT</p>
<p>RU108E</p> <p>INLETS ½" PEX (ASTM F1960)</p> <p>OUTLETS ½" NOM. COPPER SWEAT or ½" MALE NPT</p> <p><i>Valve can be rotated 180° for ceiling mount supply lines</i></p>	<p>RU108ESS</p> <p>INLETS ½" PEX (ASTM F1960)</p> <p>OUTLETS ½" NOM. COPPER SWEAT or ½" MALE NPT</p> <p><i>Valve can be rotated 180° for ceiling mount supply lines</i></p>
CPVC	
<p>RU109</p> <p>INLETS ½" NOM CPVC</p> <p>OUTLETS ½" NOM. COPPER SWEAT or ½" MALE NPT</p>	<p>RU109SS</p> <p>INLETS ½" NOM CPVC</p> <p>OUTLETS ½" NOM. COPPER SWEAT or ½" MALE NPT</p>

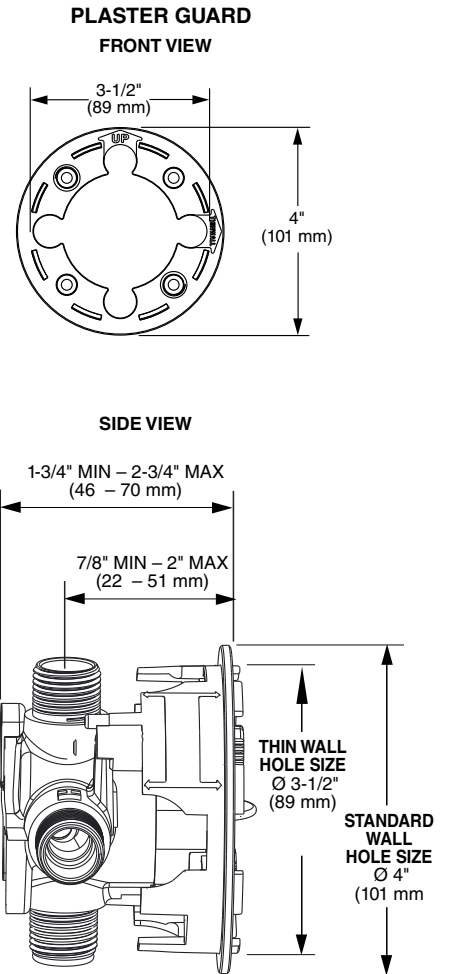

NOTE: TO AVOID SHOWER RISE OR OTHER RELATED ISSUES, DO NOT USE PEX CONNECTIONS ON ANY OF THE OUTLETS.

CODES AND STANDARDS

These products meet or exceed the following codes and standards:

ASSE 1016 / ASME A112.18.1016 / CSA B125.16

ASME A112.18.1 / CSA B125.1

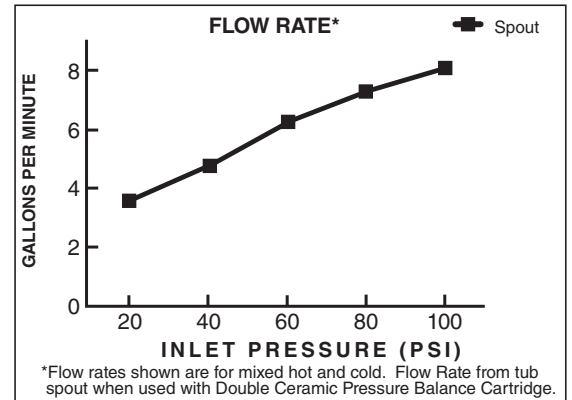

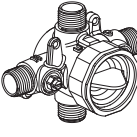
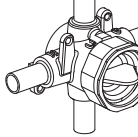
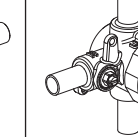
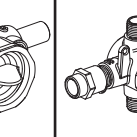
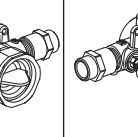
UNIVERSAL		STUB-OUT FOR PRESS-CONNECT FITTINGS		CPVC	
RU101	RU101SS	RU102	RU102SS	RU109	RU109SS
					
½" Universal Inlets/ Outlets	½" Universal Inlets/ Outlets	½" Stub-Out Inlets/ Outlets	½" Stub-Out Inlets/ Outlets	½" CPVC Inlets/ Universal Outlets	½" CPVC Inlets/ Universal Outlets
	Screwdriver Stops		Screwdriver Stops		Screwdriver Stops

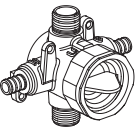
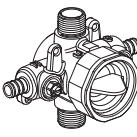
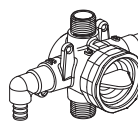
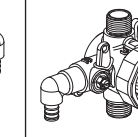
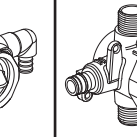
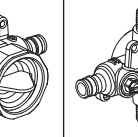
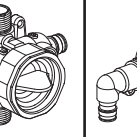
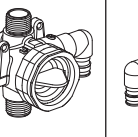
PEX - CRIMP (ASTM F1807)				PEX - COLD EXPANSION (ASTM 1960)			
RU107	RU107SS	RU107E	RU107ESS	RU108	RU108SS	RU108E	RU108ESS
							
½" PEX Crimp Inlets/ Flash Outlets	½" PEX Crimp Inlets/ Universal Outlets	½" PEX Crimp Elbow Inlets/ Universal Outlets	½" PEX Crimp Elbow Inlets/ Universal Outlets	½" PEX Cold Expansion Inlets/ Universal Outlets	½" PEX Cold Expansion Inlets/ Universal Outlets	½" PEX Cold Expansion Elbow Inlets/ Universal Outlets	½" PEX Cold Expansion Elbow Inlets/ Universal Outlets
	Screwdriver Stops		Screwdriver Stops		Screwdriver Stops		Screwdriver Stops

*Universal = Male IPS Thread/Female Sweat

OPTIONAL ACCESSORIES	
M954334-0070A	Flush Plug
M954805-0070A	Deep Rough-in Kit