

Installation the same regardless of model shown.

La instalación es la misma sin importar el modelo que se illustre.
L'installation est la même pour tous les modèles représentés.

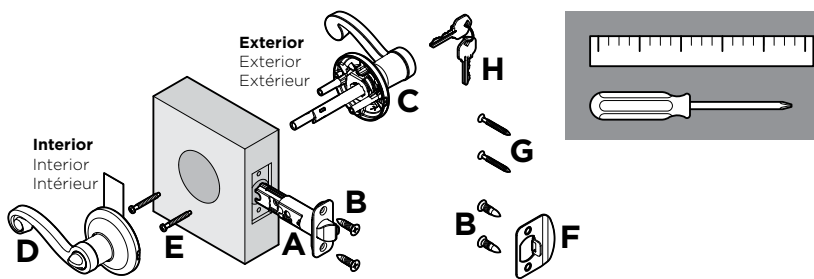

1 Check Dimensions
Revise las medidas
Vérifier les dimensions

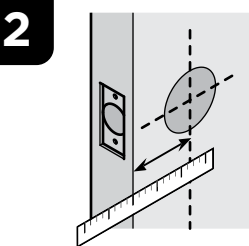
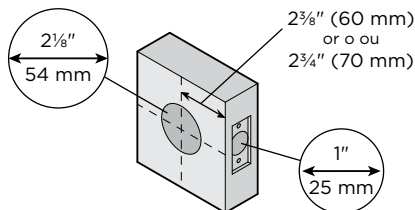

If • Si • Si:
2 3/8" (60 mm)

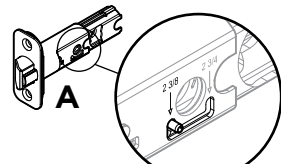

If • Si • Si:
2 3/4" (70 mm)

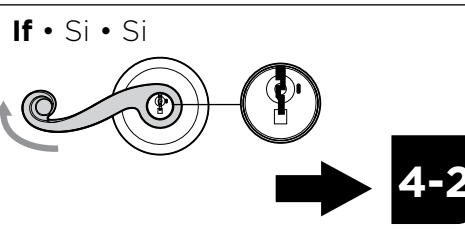
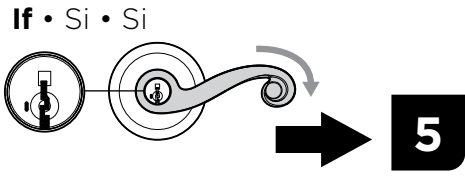
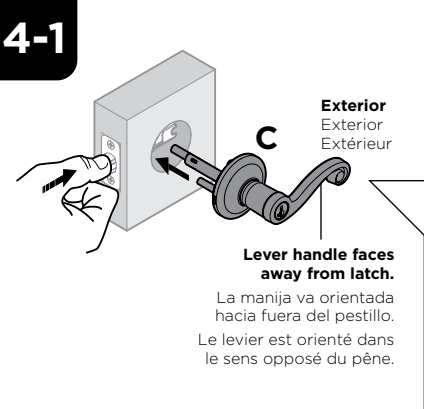
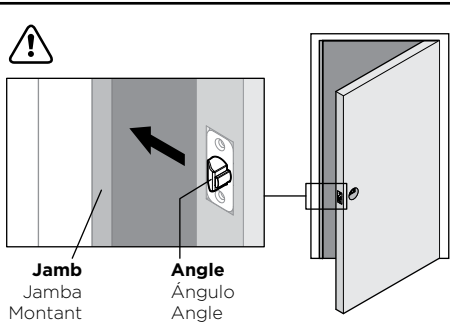
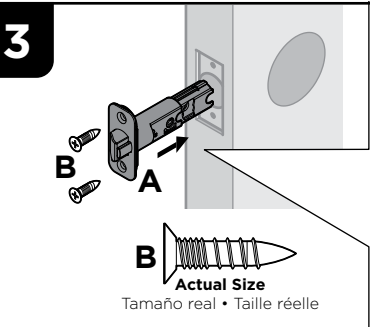
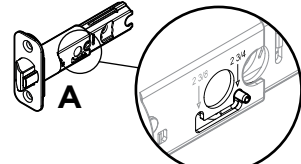

4-2 **Only perform step 4-2 if needed (see step 4-1).**
Realice el paso 4-2 sólo si es necesario (véase el paso 4-1).
Effectuer étape 4-2 seulement si nécessaire (voir étape 4-1).

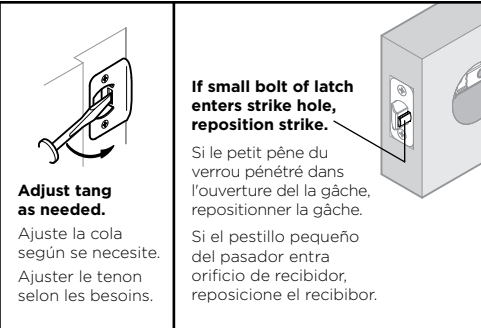
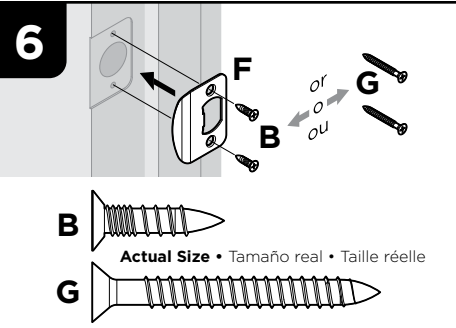
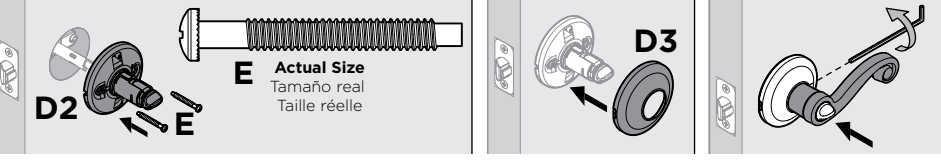
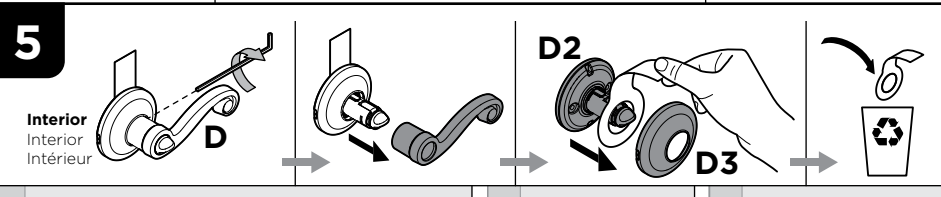
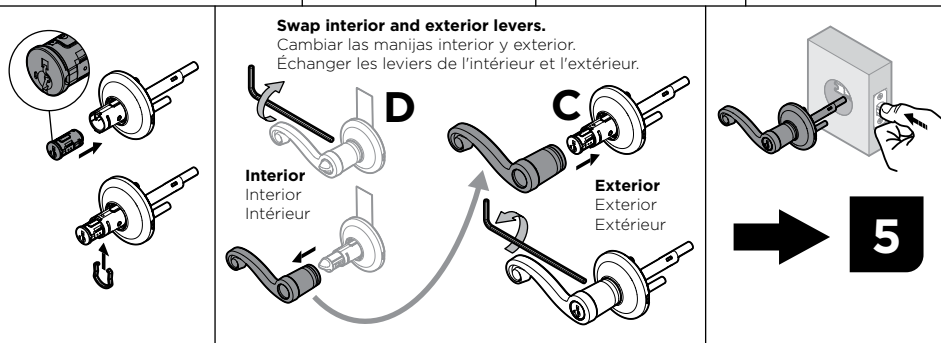
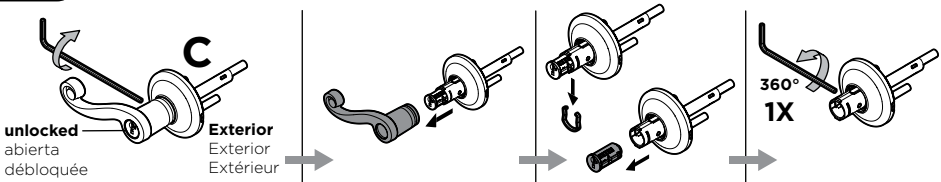

Drilling Instructions (if required)

Instrucciones para taladrar (si es necesario) • Instructions de perçage (si nécessaire)

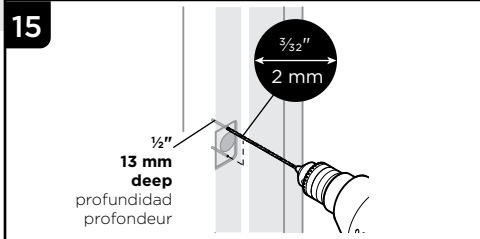
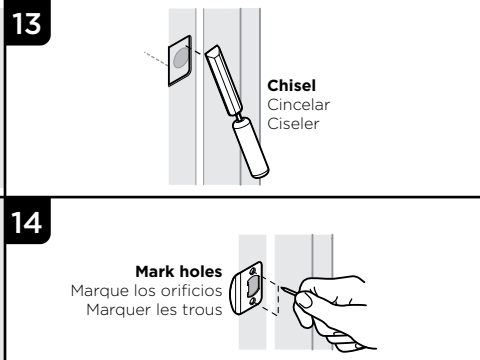
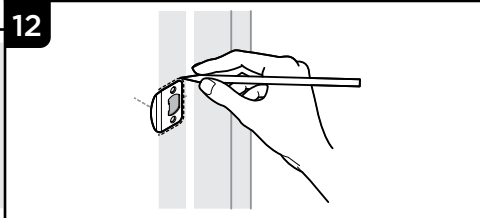
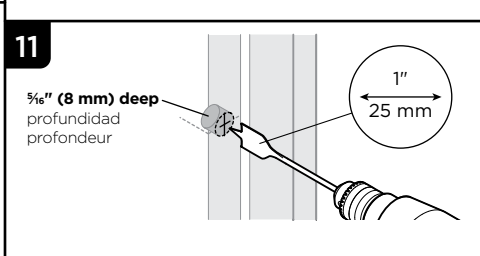
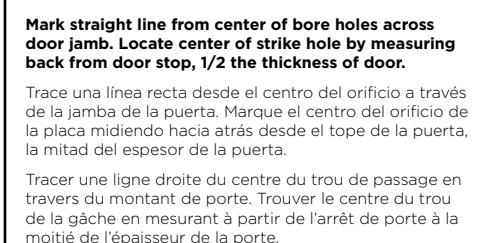
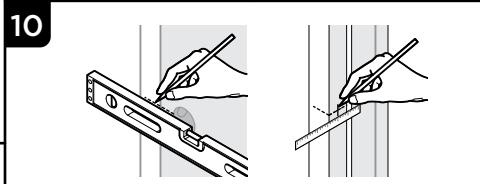
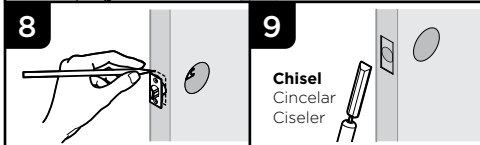
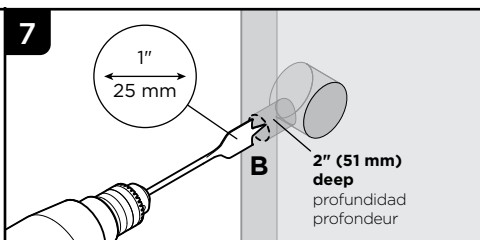
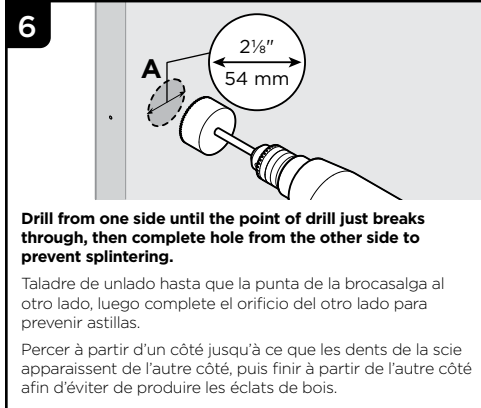
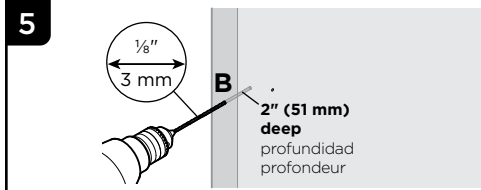
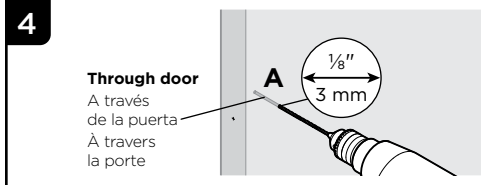
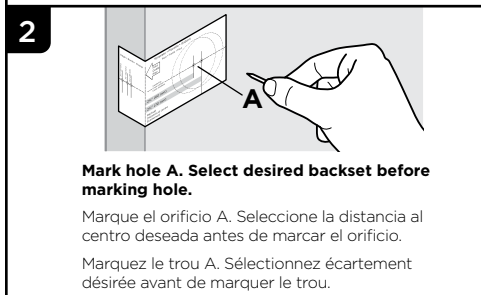
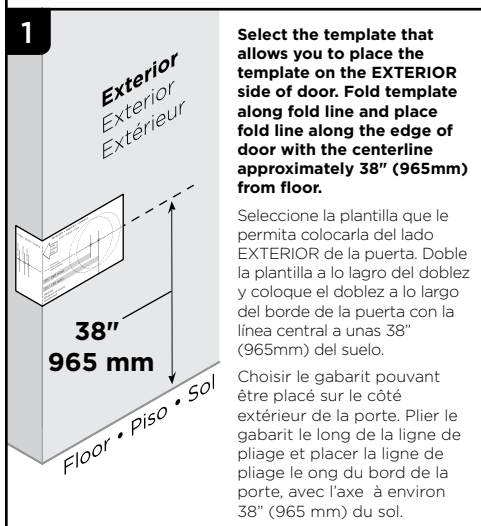
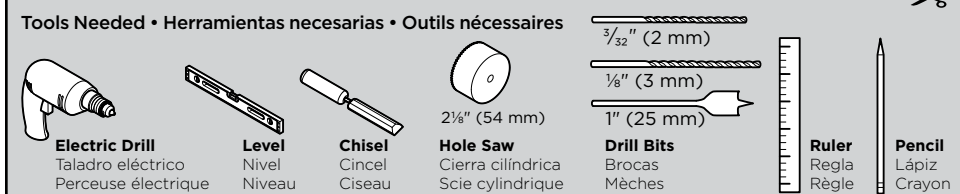
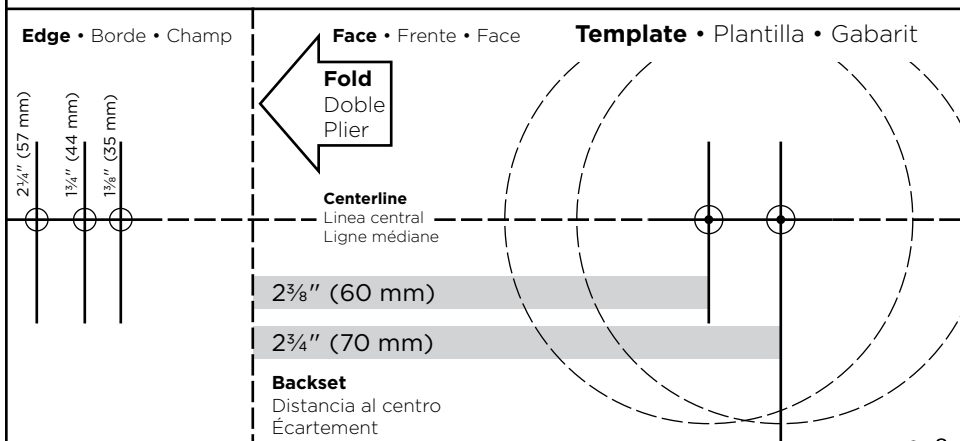

WARNING: This Manufacturer advises that no lock can provide complete security by itself. This lock may be defeated by forcible or technical means, or evaded by entry elsewhere on the property. No lock can substitute for caution, awareness of your environment, and common sense. Builder's hardware is available in multiple performance grades to suit the application. In order to enhance security and reduce risk, you should consult a qualified locksmith or other security professional.

ADVERTENCIA: Este Fabricante hace saber que no hay cerrojos que puedan proporcionar completa seguridad por sí mismos. Puede hacerse que falle este cerrojo forzándolo o utilizando medios técnicos, o puede evadirse entrando por otra parte de la propiedad. No hay cerrojos que puedan hacer de sustitutos para la precaución, el estar al tanto del entorno, y el sentido común. Pueden obtenerse piezas de ferretería de constructor con diversos grados de rendimiento para ajustarse a la aplicación. Para realizar la seguridad y reducir los riesgos, debe consultar con un cerrajero capacitado u otro profesional de seguridad.

AVERTISSEMENT: Le fabricant tient à vous aviser qu'aucun verrou ne peut à lui seul offrir une sécurité complète. Ce verrou peut être mis hors d'état par la force ou des moyens techniques ou être évité par l'utilisation d'une autre entrée sur la propriété. Aucun verrou ne peut remplacer la surveillance de votre environnement et le bon sens. Différentes qualités de matériel d'installation sont offertes pour différentes applications. Afin d'augmenter la sécurité et de réduire le risque, vous devriez consulter un serrurier qualifié ou un autre professionnel de la sécurité.

For assistance or warranty information: Si desea ayuda o información sobre la garantía: Pour de l'aide ou des informations sur la garantie:

For Kwikset product, call 1-800-327-5625, USA & CANADA or visit www.kwikset.com

Para el producto de Kwikset, llame al 1-800-327-5625, USA & CANADA o visite www.kwikset.com

Pour le produit Kwikset, veuillez appeler le 1-800-327-5625, USA & CANADA ou visiter www.kwikset.com

For Weiser product, call 1-800-677-5625 USA 1-800-501-9471 CANADA or visit www.weiserlock.com

Para el producto de Weiser, llame al 1-800-677-5625 USA 1-800-501-9471 CANADA o visite www.weiserlock.com

Pour le produit Weiser, veuillez appeler le 1-800-677-5625 USA 1-800-501-9471 CANADA ou visiter www.weiserlock.com