

Gas Slide-in Range

Installation manual

NX58*9420S*



SAMSUNG

WARNING: If the information in this manual is not followed exactly, a fire or explosion may result causing property damage, personal injury or death.

- **DO NOT** store or use gasoline or other flammable vapors and liquids in the vicinity of this or any other appliance.
- **WHAT TO DO IF YOU SMELL GAS:**
 - **DO NOT** try to light any appliance.
 - **DO NOT** touch any electrical switch.
 - **DO NOT** use any phone in your building.
 - Immediately call your gas supplier from a neighbor's phone. Follow the gas supplier's instructions.
 - If you cannot reach your gas supplier, call the fire department.
- Installation and service must be performed by a qualified installer, service agency, or the gas supplier.

ANTI-TIP DEVICE



▲ WARNING

ALL RANGES CAN TIP, RESULTING IN PERSONAL INJURY. TIPPING RANGES CAN CAUSE BURNS FROM SPILLS, PERSONAL INJURY, AND/OR DEATH. INSTALL AND CHECK THE ANTI-TIP BRACKET FOLLOWING THE INSTRUCTIONS AND TEMPLATE SUPPLIED WITH THE BRACKET.



- To prevent accidental tipping of the range, attach an approved anti-tip device to the floor. (See Installing the Anti-Tip Device in the Installation Instructions.) Check for proper installation by carefully tipping the range forward. The anti-tip device should engage and prevent the range from tipping over.
- If the range is pulled out away from the wall for any reason, make sure the anti-tip device is reengaged after the range has been pushed back into place.
- Follow the installation instructions found in the Installation Manual. Failure to follow these instructions can result in death, serious personal injury, and / or property damage.
- **DO NOT step / sit / lean** on the door or drawer to prevent accidental tipping of the range.

Contents

Before you begin	3
Important safety information	4
Gas range components	11
Overview	11
What's in the box	11
Gas range specifications	12
Installation requirements	14
Location requirements	14
To avoid breakage	16
Gas requirements	17
Special gas requirements (gas models sold in Massachusetts)	18
Electrical requirements	18
Installation instructions	20
Installing your gas range	20
Step 1. Unpack the range	20
Step 2. Connect the range to gas supply	20
Step 3. Convert to lp gas (optional)	21
Step 4. Install the anti-tip device	22
Step 5. Plug in and place	22
Step 6. Level the range	23
Step 7. Assemble the surface burners	23
Step 8. Check the ignition of surface burners	24
Step 9. Final installation checklist	25
Adjusting the oven burner air adjustment shutters	26

Before you begin

About this manual

READ THESE INSTRUCTIONS COMPLETELY AND CAREFULLY.

Important note to the installer

- Read all instructions contained in these installation instructions before installing the range.
- Remove all packing materials from the oven compartments before connecting the electric and gas supply to the range.
- Observe all governing codes and ordinances.
- Be sure to leave these instructions with the consumer.
- Installation of this appliance requires basic mechanical skills.
- Proper installation is the responsibility of the installer.
- Product failure due to improper installation is not covered under the Warranty.

Important note to the consumer

Keep these instructions with your user manual for future reference.

- As when using any appliance generating heat, there are certain safety precautions you should follow.
- Be sure your range is installed and grounded properly by a qualified installer or service technician.
- Make sure the wall coverings around the range can withstand the heat generated by the range.
- Cabinet storage space above the surface burners should be a minimum of 30 in (76.2 cm).

Important note to the servicer

The electrical diagram is in an envelope attached to the back of the range.

Important safety information

READ ALL INSTRUCTIONS BEFORE USING THIS APPLIANCE

- All electrical and gas equipment with moving parts can be dangerous. Please read the important safety instructions for this appliance in this manual. The instructions must be followed to minimize the risk of injury, death, or property damage.
- Save this manual. Please Do Not Discard.

Symbols used in this manual

WARNING

Hazards or unsafe practices that may result in severe personal injury or death.

CAUTION

Hazards or unsafe practices that may result in electric shock, personal injury, or property damage.

NOTE

Useful tips and instructions.

These warning icons and symbols are here to prevent injury to you and others. Please follow them explicitly. After reading this section, keep it in a safe place for future reference.

California Proposition 65 Warning

WARNING

Cancer and Reproductive Harm - www.P65Warnings.ca.gov.

Commonwealth of Massachusetts

- This product must be installed by a licensed plumber or gas fitter qualified or licensed by the State of Massachusetts. When using ball-type gas shut-off valves, you must use the T-handle type. Multiple flexible gas lines must not be connected in series.

General safety

WARNING

To reduce the risk of fire, electric shock, personal injuries, and/or death, obey the following precautions.

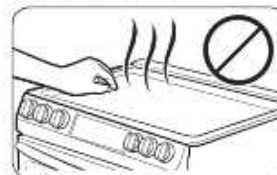

- **Do not touch** any part of the range, including but not limited to, oven burners, surface burners, or interior surfaces during or immediately after cooking.
- **Know** the location of the gas shut-off valve and how to shut it off.
- **Make sure** the anti-tip device is properly installed on the range. See the installation instructions for more information.
- **Do not let children near**, in, or on the range. Do not let children play with the range or any part(s) of the range. Do not leave children unattended in an area where the range is in use. For children's safety, we recommend utilizing the control/door lockout feature.
- **Remove** all packaging materials from the range before operating to prevent ignition of these materials. Keep all packaging materials out of children's reach. Properly dispose the packaging materials after the range is unpacked.

- **Do not store** any object of interest to children on the cooktop or backguard of the range. Children climbing on the range to reach items could be killed or seriously injured.
- **Do not operate** the range if the range or any part of the range is damaged, malfunctioning, or missing parts.
- **Do not use** the range as a space heater. This range is to be used for cooking purposes only.
- **Do not use** oven cleaners or oven liners in or around any part of the oven.
- **Use** only dry pot holders.
- **Do not use** the range to heat unopened food containers.
- **Do not strike** the oven glass.
- When disposing of the range, **cut off** the power cord and **remove** the door.
- **Unplug** or **disconnect** power before servicing.
- **Make sure** all meat and poultry is cooked thoroughly. Meat should always be cooked to an internal temperature of 160 °F (71 °C). Poultry should always be cooked to an internal temperature of 180 °F (82 °C).

Fire safety

▲ WARNING

To reduce the risk of fire, electric shock, personal injuries, and/or death, obey the following precautions.



- **Do not store, place, or use** flammable or combustible materials such as paper, plastic, pot holders, linens, curtains, gasoline or other flammable vapors or liquids near the range.
- **Do not wear** loose fitting or hanging garments while using the range.
- To avoid grease buildup, **regularly clean** the vents.
- **Do not let** pot holders or other flammable materials touch a heating element. Do not use a towel or other bulky cloths in place of a pot holder.
- **Do not use** water on a grease fire. To put out a grease fire, turn off the heat source and smother the fire with a tight-fitting lid or use a multipurpose dry chemical or foam-type fire extinguisher.
- If a grease fire should occur in the oven, **turn off the oven** by pressing the **OFF/CLEAR** button. **Keep** the oven door closed until the fire goes out. If necessary, use a multipurpose dry chemical or foam-type fire extinguisher.
- **Do not heat** unopened food containers - buildup of pressure may cause container to burst and result in injury.

Important safety information

Gas safety

▲ WARNING

To reduce the risk of fire, electric shock, personal injuries, and/or death, obey the following precautions.

If you smell gas:

- Close the valve and do not use the range.
- Do not light a match, candle, or cigarette.
- Do not turn on any gas or electric appliances.



- Do not touch any electrical switches or plug a power cord into an outlet.
- Do not use any phone in your building.
- Evacuate the room, building, or area of all occupants.
- Immediately call your gas supplier from a neighbor's phone. Follow the gas supplier's instructions.
- If you cannot reach your gas supplier, call the fire department.

Checking for gas leaks

- Leak testing of the appliance shall be conducted according to the manufacturer's instructions. Do not use a flame to check for gas leaks. Use a brush to spread a soapy water mixture around the area you are checking. If there is a gas leak, you will see small bubbles in the soapy water mixture at the leak point.

Electrical and grounding safety

▲ WARNING

To reduce the risk of fire, electric shock, personal injuries, and/or death, obey the following precautions.

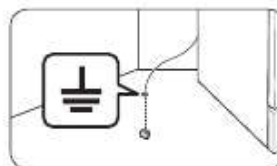

- Plug into a grounded 3-prong outlet.
- Do not remove the ground prong.
- Do not use an adapter or an extension cord.
- Do not use a damaged power plug, power cord, or loose power outlet.
- Do not modify the power plug, power cord, or power outlet in any way.
- Do not put a fuse in a neutral or ground circuit.
- Use a dedicated 120-volt, 60-Hz, 20-amp, AC, fused electrical circuit for this range. A time-delay fuse or circuit breaker is recommended. Do not plug more than one appliance into this circuit.
- Do not connect the ground wire to plastic plumbing lines, gas lines, or hot water pipes.
- This range **must be Earth grounded**. In the event of a malfunction or breakdown, grounding will reduce the risk of electrical shock by providing a path for the electric current. This range is equipped with a cord having a grounding plug. The plug must be firmly plugged into an outlet that is properly installed and grounded in accordance with the local codes and ordinances. If you are unsure whether your electrical outlet is properly grounded, have it checked by a licensed electrician.
- The range is supplied with a 3-pronged grounded plug. This cord must be plugged into a mating, grounded 3-prong outlet that meets all local codes and ordinances. If codes permit the use of a separate ground wire, we recommend that a qualified electrician determine the proper path for this ground wire.
- Electrical service to the range must conform to local codes. Barring local codes, it should meet the latest ANSI/NFPA No. 70 - Latest Revision (for the U.S.) or the Canadian Electrical Code CSA C22.1 - Latest Revisions.
- It is the personal responsibility of the range owner to provide the correct electrical service for this range.

Installation safety

▲ WARNING

To reduce the risk of fire, electric shock, personal injuries, and/or death, obey the following precautions.



- Have your range installed and properly grounded by a **qualified installer**, in accordance with the installation instructions. Any adjustment and service should be performed only by qualified gas range installers or service technicians.
- **Do not attempt** to service, modify, or replace your range or any part of your range unless it is specifically recommended in this manual. All other service should be referred to a qualified technician.
- Always use new flexible connectors when installing a gas appliance. **Do not use** old flexible connectors.
- **Make sure** the anti-tip device is properly installed on the range. See the installation instructions for more information.
- Due to the size and weight of the range, have **two or more people** move the range.
- **Remove** all tape and packaging materials.
- **Remove** all accessories from the cooktop, oven, and/or lower drawer. Grates and griddles are heavy. Use caution when handling them.
- **Make sure** no parts came loose during shipping.

- **Make sure** your range is correctly installed and adjusted by a qualified service technician or installer for the type of gas (natural or LP) you will use. For your range to utilize LP gas, the installer must replace the 5 surface burner orifices and 2 oven orifices with the provided LP orifice set, and reverse the GPR adapter. These adjustments must be made by a qualified service technician in accordance with the manufacturer's instructions and all codes and requirements of the authority having jurisdiction. The qualified agency performing this work assumes the gas conversion responsibility.
- Installation of this range must conform with local codes or, in the absence of local codes, with the National Fuel Gas Code, ANSI Z223.1/NFPA.54, latest edition. In Canada, installation must conform with the current Natural Gas Installation Code, CAN/CGA-B149.1, or the current Propane Installation Code, CAN/CGA-B149.2, and with local codes where applicable. This range has been design-certified by ETL according to ANSI Z21.1, latest edition, and Canadian Gas Association according to CAN/CGA-1.1, latest edition.

Important safety information

Location safety

▲ WARNING

To reduce the risk of fire, electric shock, personal injuries, and/or death, obey the following precautions.



- This range is for indoor, household use only. **Do not install** the range in areas exposed to the weather and/or water.
- **Do not install** the range in a place which is exposed to a strong draft.

- Select a level, well-constructed floor that can support the range's weight. Synthetic flooring, such as linoleum, must withstand 180 °F (82 °C) temperatures without shrinking, warping, or discoloring. **Do not install** the range directly over interior kitchen carpeting unless a sheet of ¼ inch plywood or a similar insulator is placed between the range and carpeting.
- Select a location where a grounded, 3- prong outlet is easily accessible.
- If the range is located near a window, **do not hang** long curtains or paper blinds on that window.
- For the range to ventilate properly, make sure the range's vents are not blocked, and that there is enough clearance at the top, back, sides, and underneath the range. The vents allow the necessary exhaust for the range to operate properly with correct combustion.
- **Make sure** the wall coverings around the range can withstand heat up to 194 °F (90 °C) generated by the range.
- Cabinet storage above the surface of the range should be avoided. If cabinet storage above the range is necessary: allow a minimum clearance of 40 inches (102 cm) between the cooking surface and the bottom of cabinets; or install a range hood that projects horizontally a minimum of 5 inches (12.7 cm) beyond the bottom of the cabinets.

Cooktop safety

▲ WARNING

To reduce the risk of fire, electric shock, personal injuries, and/or death, obey the following precautions.

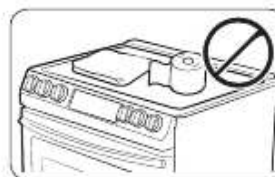

- **Make sure** all burners are off when not in use.
- **Do not use** aluminium foil to line the grates or any part of the cooktop.
- **Do not leave** burners unattended on medium or high heat settings.
- Before igniting, **make sure** all burner caps are properly in place and all burners are level.
- Always use the LITE position when igniting the burners and make sure the burners have ignited. If ignition fails, turn the knob to OFF and wait until the gas has dissipated.
- When you set a burner to simmer, **do not turn** the knob quickly. Make sure the flame stays on.
- **Do not** place any objects other than cookware on the cooktop.
- This cooktop is designed to cook with a wok or wok ring attachment. If foods are flamed, they should only be flamed under a ventilation hood that is on.
- Before removing or changing cookware, turn off the burners.
- Remove food and cookware immediately after cooking.
- Before removing any parts of the burner for cleaning, make sure the range is off and completely cool.
- After cleaning the burner spreader, **make sure** it is completely dry before re-assembling.
- **Make sure** the spark mark on the dual burner spreader is placed beside the electrode when it is assembled.
- To avoid carbon monoxide poisoning, **do not pour** water into the cooktop well while cleaning.
- Select cookware that is designed for top-range cooking. Use cookware that is large enough to cover the burner grates. Adjust the burner flames so that the flames do not extend beyond the bottom of the cookware.
- To avoid cookware discoloration, deformity, and/or carbon monoxide poisoning, **do not use** cookware that is exceedingly larger than the grate.

- **Make sure** cookware handles are turned to the side or rear of the cooktop, but not over other surface burners.
- Stand away from the range while frying.
- Always heat frying oils slowly, and watch as they heat. If you are frying foods at high heat, carefully watch during the cooking process. If a combination of fats or oils is to be used during frying, mix them together before heating.
- Use a deep-fryer thermometer whenever possible. This prevents overheating the fryer beyond the smoking point.
- Use a minimum amount of oil when shallow pan-frying or deep-frying. Avoid cooking unfrozen food or food with excessive amounts of ice.
- Before moving cookware full of fats or oils, make sure it has completely cooled.
- To prevent delayed eruptive boiling, always allow heated liquids to stand at least 20 seconds after you have turned off the burner so that the temperature in the liquid can stabilize. In the event of scalding, follow these first aid instructions:
 1. Immerse the scalded area in cool or lukewarm water for at least 10 minutes.
 2. Do not apply any creams, oils, or lotions.
 3. Cover with a clean, dry cloth.

Oven safety

⚠ WARNING

To reduce the risk of fire, electric shock, personal injuries, and/or death, obey the following precautions.



- **Do not use** the oven for non-cooking purposes such as drying clothes or storage. Use the oven for cooking purposes only.

- **Make sure** the inner portion of the split oven-rack is in the proper position within the outer rack.
- **Make sure** the oven racks are placed on the same level on each side.
- **Do not damage, move, or clean** the door gasket.
- **Do not spray** water on the oven glass while the oven is on or just after you have turned it off.
- **Do not use** aluminium foil or foil liners anywhere in the oven. Do not use aluminium foil or like material to cover any holes or passages in the oven bottom or to cover an oven rack.
- Stand away from the oven when opening the oven door.
- Keep the oven free from grease buildup.
- When repositioning the oven racks, make sure the oven is completely cool.
- **Only use** cookware that is recommended for use in gas ovens.
- To avoid damaging the burner control knobs, always bake and/or broil with the oven door closed.
- **Do not broil** meat too close to the burner flame. Trim excess fat from meat before cooking.
- When using cooking or roasting bags in the oven, follow the manufacturer's directions.

Important safety information

Storage drawer safety

▲ WARNING

To reduce the risk of fire, electric shock, personal injuries, and/or death, obey the following precautions.

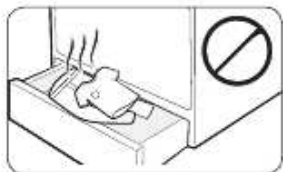

- **Do not use** the drawer for non-cooking purposes such as drying clothes or storage. Use the drawer for cooking purposes only.

- **Do not touch** the interior drawer surface or heating element.
- To avoid steam burns, use caution when opening the drawer.
- **Do not use** aluminium foil to line the drawer.
- **Do not use** the drawer in the oven. **Do not put** the drawer in the oven during a self-cleaning cycle.
- **Do not leave** containers of fat drippings in or near the drawer.

Self-cleaning oven safety

▲ WARNING

To reduce the risk of fire, electric shock, personal injuries, and/or death, obey the following precautions.



- The self-cleaning feature operates the oven at temperatures high enough to burn away food soils in the oven. The range is extremely hot during a self-cleaning cycle. **Do not touch** any surfaces of the range during a self-cleaning cycle.
- Keep children away from the oven during a self-cleaning cycle.
- Before starting a self-cleaning cycle, **remove** all racks, cookware, and utensils from the oven. Only porcelain-coated oven racks may be left in the oven.
- Before starting a self-cleaning cycle, wipe grease and food soils from the oven.
- **Do not put** the lower drawer into the oven cavity when you run a self-cleaning cycle.
- When opening the door after a self-cleaning cycle, stand away from the oven.
- If the self-cleaning cycle malfunctions, turn off the oven, disconnect the power supply, and contact a qualified service technician.

Gas range components

Overview

MODEL NX58*9420S*

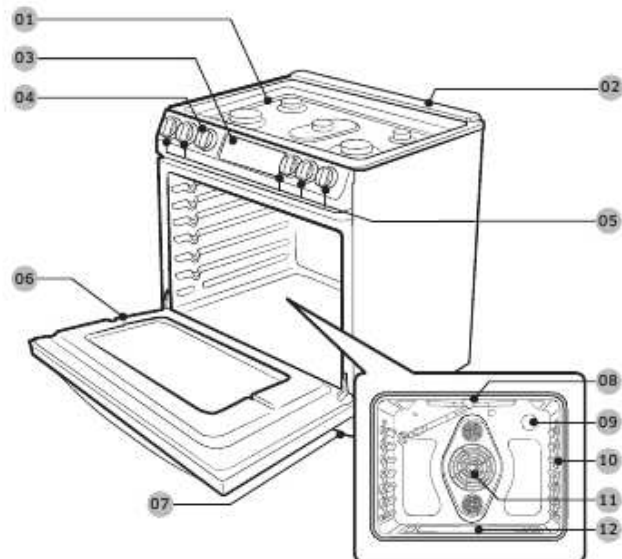

- | | | |
|-----------------------------------|--|-------------------------------|
| 01 Surface burners | 02 Oven vents / Cooling vent | 03 Touch display |
| 04 Oven lights Knob (1 pc) | 05 Surface burner knobs (5 pcs) | 06 Removable oven door |
| 07 Storage drawer | 08 Broil oven burner | 09 Oven light |
| 10 Oven rack system | 11 Convection fan | 12 Bake oven burner |

NOTE

If you need a part marked with a "*", you can buy it from the Samsung Contact Center (1-800-726-7864).

What's in the box

Parts supplied

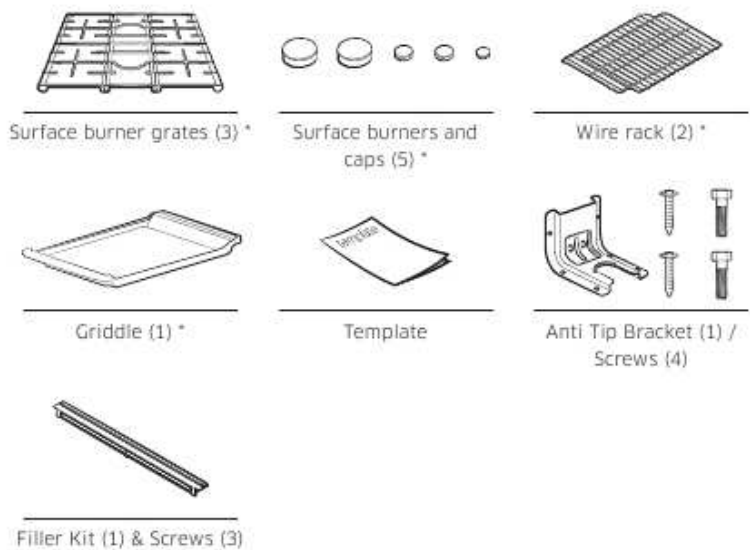

- Make sure you have received all of the supplied parts shown above.
- If your range was damaged during shipping or you do not have all of the supplied parts, contact your local retailer.

NOTE

If you need an accessory marked with an "*" (asterisk), please contact the Samsung Call Center using the phone number listed on the last page of this manual or visit our on-line parts web site at www.samsungparts.com.

Gas range components

Gas range components

Parts needed



Gas line shut-off valve



Flexible metal appliance connector
1/2 in (ID) x 5 ft



Flare union adapter
3/4 in or 1/2 in (NPT) x
1/2 in (ID)



Flare union adapter
1/2 in (NPT) x 1/2 in
(ID)



135-degree elbow
(optional)



Lag bolt or 1/2-in
(OD) sleeve anchor

Tools needed



Flat-blade
screwdriver



Phillips screwdriver



Open-end or
adjustable wrench



Pipe wrench (2)



1/4" Nut driver



Pencil and ruler



Level



Pipe joint compound



Utility knife



Soapy water
solution



Pliers

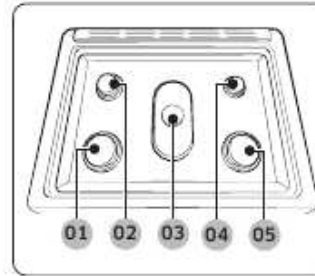

BTU Ratings (NG)

- 01 Left-Front: 15,000 BTU
- 02 Left-Rear: 9,500 BTU
- 03 Center: 9,500 BTU
- 04 Right-Rear: 5,000 BTU
- 05 Right-Front: 17,000 BTU

BTU Ratings (LP)

- 01 Left-Front: 11,500 BTU
- 02 Left-Rear: 7,500 BTU
- 03 Center: 7,500 BTU
- 04 Right-Rear: 4,000 BTU
- 05 Right-Front: 12,500 BTU

Gas range specifications

MODEL NX58*9420S*

DESCRIPTION	Gas Slide-in Range
OVERALL DIMENSIONS	29 3/16 in (W) x 36 1/4 in (H) x 28 1/16 in (D) 761.0 mm (W) x 921.2 mm (H) x 728.3 mm (D)
NET WEIGHT	200 lb (90.8 Kg)
ELECTRICAL	Refer to the rating label.
GAS, NG (NATURAL GAS)	5-13 in WC
GAS, LP (LIQUID PETROLEUM)	10-13 in WC
SURFACE BURNERS (NG)	(LF)-15,000 BTU / (LR)-9,500 BTU / (CTR)-9,500 BTU / (RR)-5,000 BTU / (RF)-17,000 BTU
SURFACE BURNERS (LP)	(LF)-11,500 BTU / (LR)-7,500 BTU / (CTR)-7,500 BTU / (RR)-4,000 BTU / (RF)-12,500 BTU
OVEN BURNERS (NG)	Broil - 16,500 BTU / Bake - 18,000 BTU
OVEN BURNERS (LP)	Broil - 11,500 BTU / Bake - 15,000 BTU

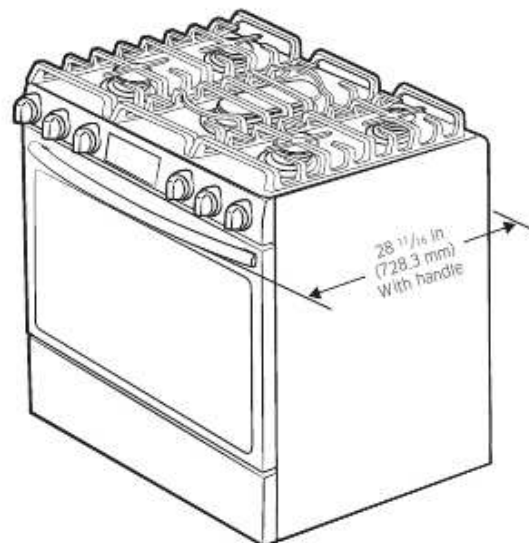
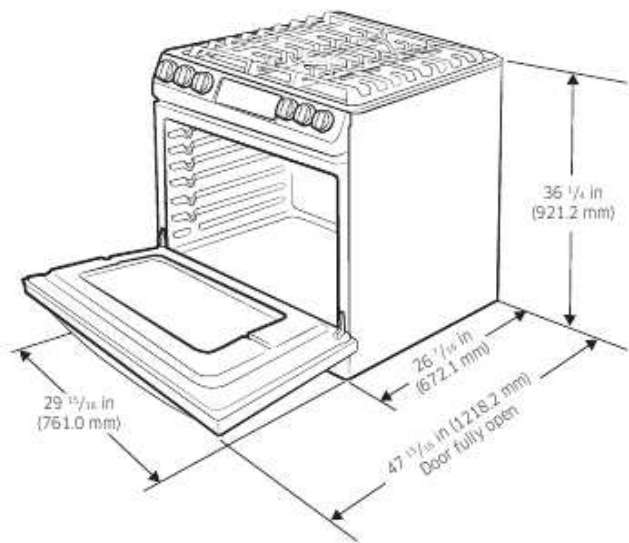

Gas range components

Installation requirements

Location requirements

Clearances and dimensions

BEFORE YOU BEGIN to install this appliance, refer to the following information, dimensions, and clearances. **Do not locate the range where it may be subject to strong drafts.** Provide adequate clearances between the range and adjacent combustible surfaces. These dimensions must be met for safe use of the range. The location of the electrical outlet and gas piping may be adjusted to meet the following dimensions and clearances.

For installation in Canada, a free-standing range is not to be installed closer than 4.7 in (12 cm) from any adjacent surface.

⚠ CAUTION

This range has been designed to comply with the maximum allowable wood cabinet temperature of 194 °F (90 °C). Make sure the wall covering, countertops, and cabinets around the range can withstand the heat (up to 194 °F [90 °C]) generated by the range. If not, discoloration, delamination, or melting may occur.

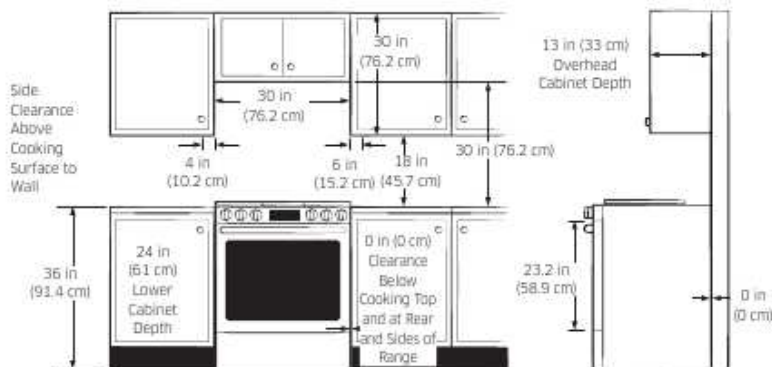

⚠ CAUTION

Do not grasp the knob, handle and push when you install.

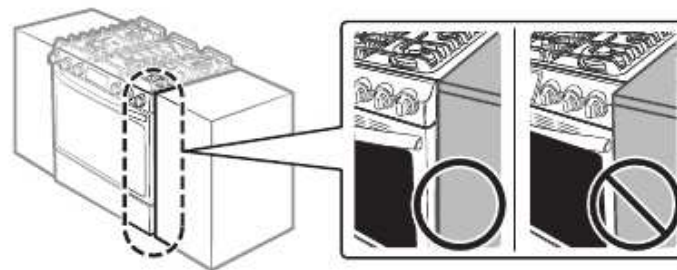

⚠ CAUTION

DO NOT install the oven so that the door is flush with the cabinet. For OTR over Gas Stove, please follow local GAS CODE.

Installation requirements

Minimum dimensions

▲ WARNING

If overhead cabinets are installed, a range hood should also be provided that projects horizontally a minimum of 5 in (12.7 cm) beyond the front of the cabinets. This will dissipate any heat buildup in the overhead cabinets to prevent death, personal injury, and/or fire hazard. The ventilating hood must be constructed of sheet metal not less than 0.0122" thick. Install above the cooktop with a clearance of not less than 1/4" between the hood and the underside of the combustible material or metal cabinet. The hood must be at least as wide as the appliance and centered over the appliance. Clearance between the cooking surface and the ventilation hood surface must never be less than 24 inches.

Exception 1 : Installation of a listed microwave oven or cooking appliance over the cooktop shall conform to the installations packed with that appliance.

- 30-in (76.2-cm) minimum clearance between the top of the cooking surface and the bottom of an unprotected wood or metal cabinet; or if no 30-in (76.2-cm) minimum clearance, 24-in (61-cm) minimum when the bottom of the wood or metal cabinet is protected by not less than 0.25-in (0.64-cm) flame-retardant millboard covered with not less than no. 28 MSG sheet steel, 0.015-in (0.038-cm) stainless steel, 0.024-in (0.061-cm) aluminum, or 0.020-in (0.051-cm) copper.
- 18-in (45.7-cm) minimum between the countertop and the adjacent cabinet bottom.

Exception 2 : For island installation, maintain 2 1/2" minimum from cutout to back edge of countertop and 4" minimum from cutout to side edges of countertop.

IMPORTANT:

To eliminate the risk of burns or fire caused by reaching over heated surface units, avoid having cabinet storage space located above the surface units. If you have cabinet storage space over the heating elements, you can reduce the risk by installing a range hood that projects horizontally a minimum of 5 inches beyond the bottom of the cabinets.

Installation guide

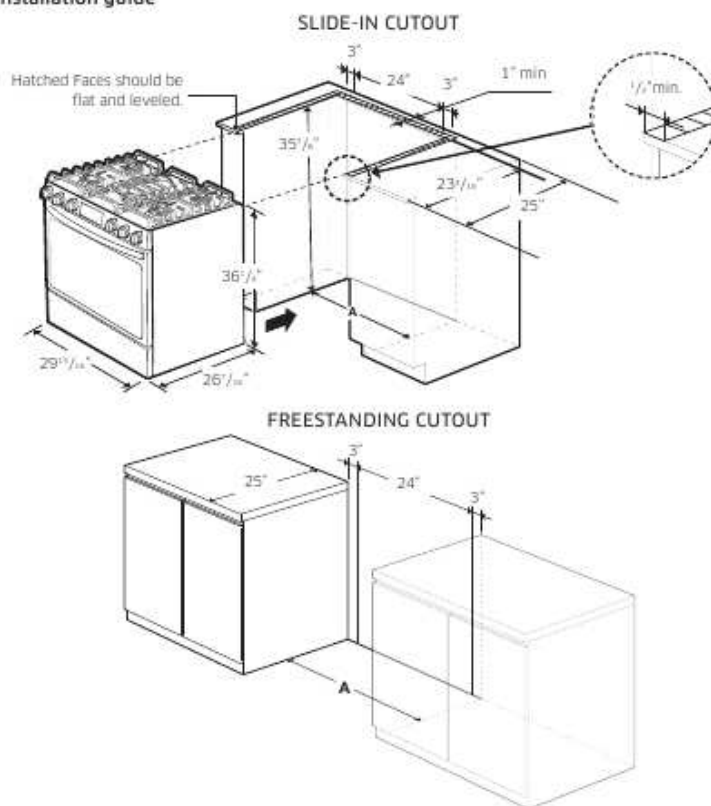

A: Cabinet opening 30" (76.2)

IMPORTANT: If height of the cabinets on either side of the range is over 36 1/4", the unit should be installed with shims under the feet for support.

Installation requirements

Recommended locations for gas piping and electrical outlets (For model NX58*9420S*)

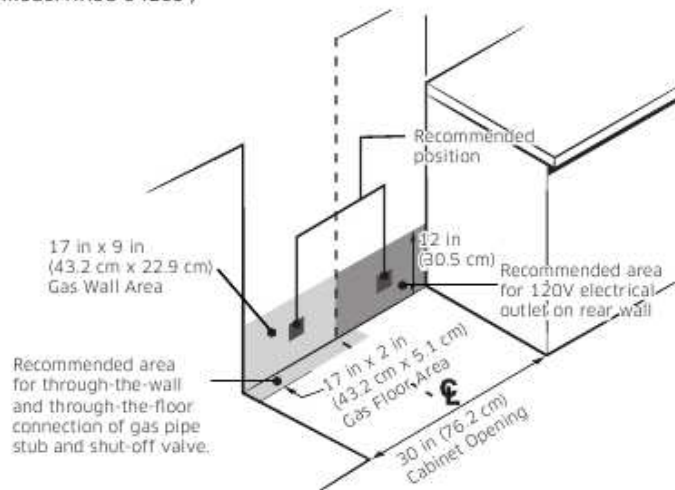

⚠ CAUTION

You must use the rear filler kit to install the range in a freestanding cutout cabinet. For more information, see "Optional rear filler kit" as shown below.

Optional rear filler kit

⚠ WARNING

Used to fill gap between the range back and wall. Adds a filler strip to the rear of the range. This kit can only be used when the opening in the countertop is 25" deep.

📌 NOTE

If the countertop depth is greater than 25", there will be a gap between the filler kit and the back wall.

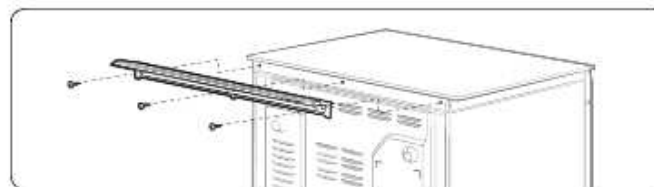

To avoid breakage



⚠ CAUTION

Please **DO NOT** push the unit strongly when you install. These actions can cause the damage to the unit.

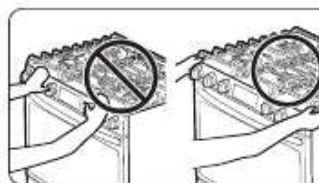

Please **DO NOT** push the burner knobs when installing the range.
(Grasp the L/R door area to push the unit.)

CAUTION

Do NOT lift or handle the unit by the cooktop frame.

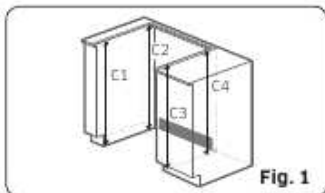
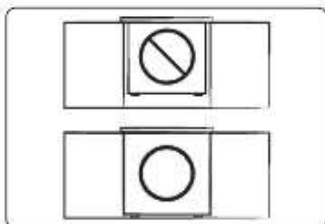
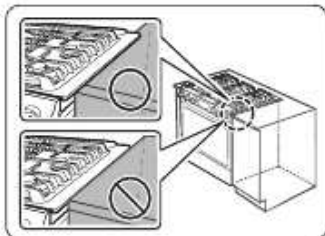

Fig. 1



1. The counter top around the cut-out should be flat and leveled (See hatched area on Fig. 1).
2. Before installing the unit, measure the heights of the two cabinet sides (C1~C4), front and back (See Fig. 1) from the floor to the top of the counter.
3. Level the range using the four leveling legs so that the height from the floor to the underside of the cooktop frame is greater than the tallest cabinet measurement by at least $\frac{1}{16}$ ".
4. Slide the unit into the cabinet (**DO NOT PUSH THE UNIT HARD**). Make sure the center of the unit aligns with the center of the cabinet cut-out.
5. The metal flange under each side of the cooktop **MUST** be placed over the cabinet countertop for proper unit support. The cooktop should **NOT** rest directly on the countertop or else it could cause damage to the cooktop voiding the warranty. Level the unit if needed.

IMPORTANT:

MAKE SURE the unit is supported by the leveling legs and **NOT** by the cooktop itself.

Gas requirements

Provide adequate gas supply

This range is designed to operate at a pressure of 5 in (13 cm) of water column on natural gas or 10 in (25 cm) of water column on LP gas (propane or butane).

Make sure you are supplying your range with the type of gas for which it is designed. **Do not attempt to convert the appliance from the gas specified in this manual to a different gas without consulting the gas supplier.**

This range is convertible for use on natural or propane gas. If you decide to use this range on LP gas, conversion must be made by a qualified LP installer before attempting to operate the range.

For proper operation, the pressure of natural gas supplied to the regulator must be between 5 in and 13 in (13 cm and 33 cm) of water column.

For LP gas, the pressure supplied must be between 10 in and 13 in (25 cm and 33 cm) of water column.

When checking for proper operation of the regulator, the inlet pressure must be at least 1 in (2.5 cm) greater than the operating (manifold) pressure as given.

The pressure regulator located at the inlet of the range manifold must remain in the supply line regardless of whether natural or LP gas is being used.

A flexible-metal appliance connector used to connect the range to the gas supply line should have an I.D. of 0.5 in (1.3 cm) and be 5 ft (152 cm) in length for ease of installation. In Canada, flexible connectors must be single-wall metal connectors no longer than 6 ft (183 cm) in length.

Do not kink or damage the flexible metal tubing when moving the range.



Installation requirements

Special gas requirements (gas models sold in massachusetts)

COMMONWEALTH OF MASSACHUSETTS REQUIREMENTS:

▲ WARNING

Gas leaks may occur in your system, creating a dangerous situation.

- Gas leaks may not be detected by smell alone.
- Gas suppliers recommend you purchase and install a UL-approved gas detector. Gas detector should be installed in accordance with the manufacturers instructions.
- Range must be installed by a qualified plumber or gas fitter by the State of Massachusetts.
- A T-handle manual gas valve MUST be installed in the gas supply line to your range.
- If a flexible gas connector is used to install your range, multiple flexible gas lines must not be connected in series.

Electrical requirements

▲ WARNING

To reduce the risk of fire, electric shock, or personal injury:

All ranges

- Do not use an extension cord or adapter plug with this range.
- This range must be properly grounded.
- Check with a qualified electrician if you are in doubt as to whether your range is properly grounded.
- Do not modify the plug provided with your range—if it doesn't fit the outlet, have a proper outlet installed by a qualified electrician.
- All wiring and grounding must be done in accordance with local codes or, in the absence of local codes, with the National Electrical Code, ANSI/NFPA No. 70 – Latest Revision (for the U.S.) or the Canadian Electrical Code CSA C22.1 – Latest Revisions and local codes and ordinances.
- Wiring diagram is located on the back of the range. (Inside of the cover back wire)
- This range is equipped with an electronic ignition system that will not operate if plugged into an outlet that is not properly polarized.

Gas models

- All gas models are equipped with a power cord with an equipment-grounding conductor and a grounding plug.
- A 120-Volt, 60-Hz, AC, approved electrical service with 20-amp circuit breaker or time-delay fuse is required for all U.S. and Canadian models.
- Check for $\frac{3}{4}$ -in (1.9-cm) UL-listed strain relief where the power cord comes out of the range cabinet.
- Do not reuse a gas supply flexible connector from an old range or other appliance.
- The power cord electric supply wiring must be retained at the range cabinet with a suitable UL-listed strain relief.
- A time-delay fuse or circuit breaker is also recommended.





Grounding

- All ranges must be grounded for personal safety.
- All gas models have a power cord with an equipment-grounding conductor and a grounding plug.
- The plug must be firmly plugged into a three-prong outlet that is properly installed and grounded in accordance with all local codes and ordinances. In the event of a malfunction or breakdown, grounding will decrease the risk of electrical shock by providing a path for the electric current.
- Do not use a damaged power plug or loose wall outlet.
- Do not use an extension cord or adapter with this appliance.
- Do not, under any circumstances, cut, modify, remove, or otherwise defeat the grounding (third) prong from the power cord. If the plug and the outlet do not match or you have any doubt, have a qualified electrician install the proper outlet.

The customer should have the wall receptacle and circuit checked by a qualified electrician to make sure the receptacle is properly grounded.

Ground Fault Circuit Interrupters (GFCIs) are not required or recommended for gas range receptacles.

- **NEVER** connect ground wire to plastic plumbing lines, gas lines, or water pipes.

CAUTION

Failure to follow these instructions can result in death, fire, or electrical shock.

Usage situations where appliance power cord will be disconnected frequently

Do not use an adapter plug in these situations because disconnecting of the power cord places undue strain on the adapter and leads to eventual failure of the adapter ground terminal. Where a standard two-prong wall receptacle is encountered, it is the personal responsibility and obligation of the customer to have it replaced with a three-prong (grounding) receptacle by a qualified electrician before using the appliance.

Additional installation requirements for mobile homes

The installation of appliances designed for mobile home installation must conform with the Manufactured Home Construction and Safety Standard, Title 24 CFR, Part 3280 (formerly the Federal Standard for Mobile Home Construction and Safety, Title 24, HUD, Part 280) or, when such standard is not applicable, the Standard for Manufactured Home Installations, latest edition (Manufactured Home Sites, Communities and Set-Ups), ANSI A225.1, latest edition, or with local codes. In Canada, mobile home installation must be in accordance with the current CAN/CSA Z240/MH Mobile Home Installation Code.

Power cord location

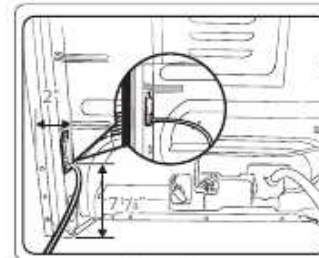

Power cord location

The power cord for this appliance is located on the back of the range, near the bottom right hand corner. The 53-in (135-cm) power cord will come installed on the range and taped to the back for shipping.



Installation instructions

Installing your gas range

IMPORTANT:

Please read the following instructions, as well as the Important Safety Instructions section at the front of this manual, completely and carefully BEFORE installing and/or operating the gas range. Improper installation, adjustment, service, or maintenance can cause personal injury or property damage.



NOTE

To order parts or accessories, contact your local retailer or refer to the last page.

NOTE

To ensure proper installation, we strongly recommend that you hire a professional installer.

Step 1. Unpack the range

Remove all packaging materials. Failure to remove packaging materials could result in damage to the appliance.

Inventory all loose parts against the Parts supplied components listed on page 11.

Check for shipping damage and/or missing parts. Any damage and/or missing parts should be reported to your local retailer.

Step 2. Connect the range to gas supply

Shut off the main gas supply valve before disconnecting the old range and leave it off until the new hookup has been completed. Don't forget to relight the pilot on other gas appliances when you turn the gas back on.

Because hard piping restricts movement of the range, the use of a CSA International-certified flexible metal appliance connector is recommended unless local codes require a hard-piped connection.

WARNING

If the information in this manual is not followed exactly, a fire or explosion may result, causing death, personal injury, or property damage.

- Do not store or use gasoline or other flammable vapors and liquids in the vicinity of this or any other appliance.
- WHAT TO DO IF YOU SMELL GAS:
 - DO NOT light a match, candle, or cigarette.
 - DO NOT try to light any appliance.
 - DO NOT touch any electrical switch.
 - DO NOT use any phone in your building.
 - Clear the room, building, or area of all occupants.
 - Immediately call your gas supplier from a neighbor's phone. Follow the gas supplier's instructions.
 - If you cannot reach your gas supplier, call the fire department.
- Installation and service must be performed by a qualified installer, service agency, or gas supplier.

Never use an old connector when installing a new range. If the hard-piping method is used, you must carefully align the pipe; the range cannot be moved after the connection is made.

To prevent gas leaks, apply pipe-joint compound or wrap pipe-thread tape with Teflon on all male (external) pipe threads.

1. Install a manual gas line shut-off valve in the gas line in an easily accessed location outside of the range.
Make sure everyone operating the range knows where and how to shut off the gas supply to the range.
2. Install male 0.5-in (1.3-mm) flare union adapter to the 0.5-in (1.3-mm) NPT internal thread at the regulator inlet. Use a backup wrench on the regulator fitting to avoid damage.
When installing the range from the front, remove the 90° elbow for easier installation.
3. Install male 0.5-in (1.3-mm) or 0.75-in (1.9-mm) flare union adapter to the NPT internal thread of the manual shut-off valve, taking care to back up the shut-off valve to keep it from turning.

4. Connect flexible metal appliance connector to the adapter on the range. Position range to permit connection at the shut-off valve.
5. When all connections have been made, make sure all range controls are in the off position and turn on the main gas supply valve. Use a liquid leak detector at all joints and connections to check for leaks in the system.

▲ WARNING

To prevent death, personal injury, explosion, and/or fire hazard, **DO NOT** use a flame to check for gas leaks.

When using test pressures greater than ½ psig to pressure-test the gas supply system of the residence, disconnect the range and individual shut-off valve from the gas supply piping. When using test pressures of ½ psig or less to test the gas supply system, simply isolate the range from the gas supply system by closing the individual shut-off valve.

▲ WARNING

Do not exceed 25 ft-lbs of torque when making gas line connections. Overtightening may crack the pressure regulator resulting in a gas leak.

Flexible connector hookup

Installer: Inform the consumer of the location of the gas shut-off valve.

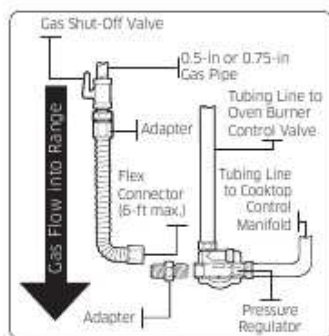

NOTE

If your area requires a rigid pipe hookup, contact a qualified installer, service agency, or gas supplier.

NOTE

The gas shut-off valve should be installed in an accessible location in the gas piping, external to the appliance, for the purpose of turning on or shutting off the gas to the appliance.

Step 3. Convert to lp gas (optional)

All new gas ranges are shipped from the factory set up to use natural gas. Any Samsung gas range can be converted to use LP gas. Refer to page 55 in the User Manual to contact a qualified service technician.

The conversion process should only be performed by a qualified LP gas installer. Conversion instructions and LP orifices will be supplied with the LP conversion kit. The conversion to LP requires all burner orifices to be changed (5 surface burners and 2 oven burners).

In addition, the nozzle on the gas pressure regulator needs to be reversed. All replaced orifices must be left with the consumer, including the instructions and retrofit sizes and orifice indication.

Checking the flame quality all burner after converting to lp gas.

BURNER ORIFICE SIZES AND OUTPUT RATINGS (LP Gas [Propane] 10 in WCP)			BURNER ORIFICE SIZES AND OUTPUT RATINGS (Natural Gas 5 in WCP)		
Burner Location	BTU Rate	Orifice Size [mm]	Burner location	BTU Rate	Orifice size [mm]
RF	12,500	1.06	RF	17,000	1.92
LF	11,500	1.04	LF	15,000	1.78
RR	4,000	0.62	RR	5,000	1.01
LR	7,500	0.83	LR	9,500	1.40
CTR	7,500	0.83	CTR	9,500	1.40
BAKE	15,000	1.15	BAKE	18,000	1.90
BROIL	11,500	1.02	BROIL	16,500	1.80

Installation instructions

Step 4. Install the anti-tip device

▲ WARNING

To reduce the risk of tipping, the appliance must be secured by properly installing the anti-tip device packed with the appliance.

- All ranges can tip, resulting in personal injury.
- Tipping ranges can cause burns from spills, personal injury, and/or death.
- To prevent accidental tipping, install and check the anti-tip bracket following the instructions and template supplied with the bracket.

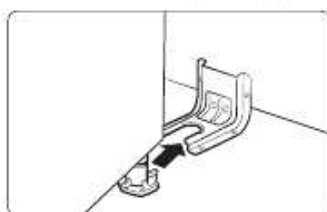

An anti-tip bracket and screws, installation instructions, and template are shipped with every range (PN DG94-00870B). The instructions include information necessary to complete the installation of the anti-tip bracket. Read and follow the instructions on the sheet and use the template for anti-tip bracket installation. If not properly installed, the range could be tipped by you or a child standing, sitting, or leaning on an open oven door.

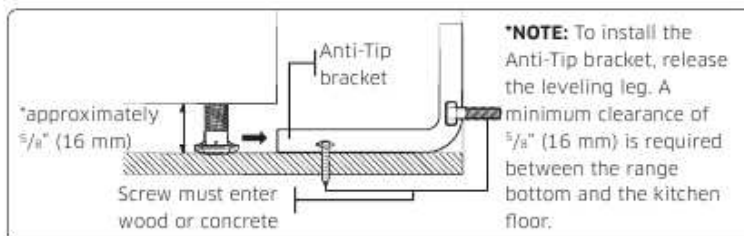

To check if the bracket is installed and engaged properly, remove storage drawer and look underneath the range to see that the leveling leg is engaged in the bracket. Carefully tip the range forward. The bracket should stop the range within 4 inches (10.2 cm) of tipping. If it does not, the bracket must be reinstalled.

If the range is pulled from the wall for any reason, always repeat this procedure to verify the range is properly secured by the anti-tip bracket. Never completely remove the leveling legs or the range will not be secured to the anti-tip device properly.

Step 5. Plug in and place

▲ WARNING

BEFORE OPERATING OR TESTING, follow the grounding requirements on pages **18-19** in this manual. Improper connection of the grounding plug can result in a risk of electric shock.

- All gas ranges come with a power cord. The power cord is connected to the rear of the range. Please review "Electrical requirements" on pages **18-19**.
 - The electrical system, including the power cord, is preinstalled and prewired at the factory. Altering any part of this system may result in a short or overload.
1. Plug in the power cord. Make sure the outlet meets local or national electrical codes as referenced on pages **18-19**.
 2. Slide the range into place.
 3. Check the gas supply line to make sure it did not get damaged and it stayed connected during positioning.
 4. Check to make sure the back leg of the range has slid into the anti-tip bracket. Carefully tip the range forward to ensure that the anti-tip bracket engages the back brace and prevents tip-over.

Step 6. Level the range



1. Make sure the range is positioned where you want it.
2. Using a wrench, level the range by turning the front leveling legs in or out as necessary. Counterclockwise shortens the leg and lowers the range. Clockwise lengthens the leg and raises the range.

NOTES

- Adjusting the two front legs is usually sufficient, but adjust all four legs if necessary.
- Adjust the leveling legs only as far as necessary to level the range. Extending the leveling legs more than necessary or removing legs can cause the range to be unstable.



3. If range is next to or between cabinets, make sure the cooktop (without the surface burner grates) is level with the countertops.
4. Position an oven rack in the center rack position.
5. Check the level of the range with a carpenter level using the two positions shown at left.
6. After the range becomes level, slide the range away from the wall so that the anti-tip bracket can be installed.

Step 7. Assemble the surface burners

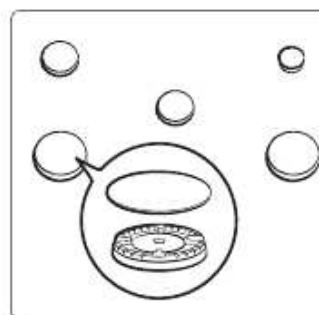

CAUTION

Do not operate the surface burners without all burner parts in place.

1. Position surface burner heads on top of the surface burner manifolds as shown at right. The electrodes will fit into the slot in the bottom of the heads. Make sure the surface burner heads are flat and parallel with the cooktop.
2. Place the matching size caps on top of each surface burner head.

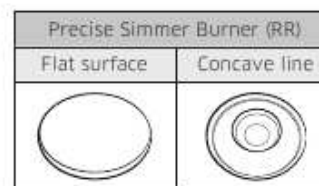

NOTE

The caps on Precise simmer burner (RR) and inside Dual Burner (RF) can be interchangeably used.

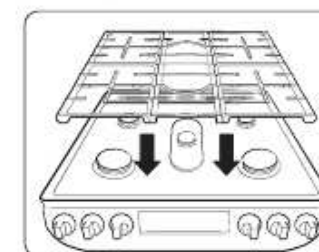

3. Place the left, center, and right surface burner grates on the cooktop. The edges of the grates should match up with the edges of the cooktop.

Installation instructions

Step 8. Check the ignition of surface burners

Check the operation of all cooktop and oven burners after the range has been installed and assembled, gas supply lines have been carefully checked for leaks, and electrical power cord has been plugged in.

All surface and oven burners have electronic ignition.

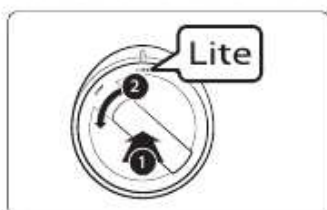

To turn on a surface burner:

1. Push in and turn the control knob for that surface burner to the Lite position. The "clicking" sound indicates the electronic ignition system is operating properly. The burner will light in about 4 seconds, after the air has been purged from the supply line.
2. After the burner lights, turn the control knob to the desired setting. The "clicking" sound will stop and the flame height will change from Max. to Min. during turning the control knob.
3. Repeat steps 1 and 2 to check the operation of each surface burner in succession.

NOTE

Place food in the oven after preheating if the recipe calls for it. Preheating is important for good baking results. After the oven has reached the desired cooking temperature, it will beep 6 times.

To start the bake burners



1. Press the **Bake**, **Roast**, or **Bake** pad.
2. If necessary, use the number pad to change the default temperature (350 °F). You can set the oven to any temperature from 175 °F to 550 °F.
3. Press the **START/SET** pad.
 - The gas oven preheats until it reaches the temperature you set.
 - When preheating is complete, place the food in the gas oven, and then close the door.
4. When cooking is complete, press the **OFF/CLEAR** pad, and then take out the food.

To start the broil burners



1. Put food on a broiling grid in a broiling pan, and then place the pan on the desired rack.
2. Press the **Broil** pad once for high temperature broiling or twice for low.
3. Press the **START/SET** pad to start cooking.
4. Let the oven pre-heat for 5 minutes.
5. Place the pan on the desired rack, and then close the oven door.

6. When one side of the food is browned, turn it over, close the oven door, and start cooking the other side.
7. When cooking is complete, press the **OFF/CLEAR** pad.

Checking the flame quality:

All combustion flames need to be visually checked to determine their flame quality.

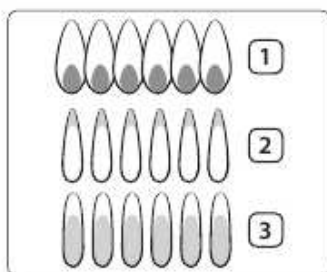

1. **Soft blue flames**—Normal for natural gas operation.
2. **Yellow tips on outer cones**—Normal for LP gas operation.
3. **Yellow flames**—Abnormal for any gas operation; call for service.

NOTE

If burner flame looks like 3, the range should not be used until it is serviced. Call for service. Normal burner flames shall look like 1 or 2, depending on the gas type you use.

Step 9. Final installation checklist

You have just completed installing your range. Make sure all controls are in the off position and the flow of ventilation air to the range is unobstructed. The following is a checklist to confirm your range is safely installed and ready for operation.

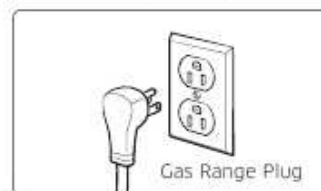

- Gas line has been properly connected to the range. The gas has been turned on. All connections have been checked for leaks.
- Range is plugged into the properly grounded electrical receptacle.
- Approved anti-tip bracket is properly installed and engaged with the range.
- Range is leveled and is firmly sitting on a solid, level floor.
- Gas surface burners have been properly assembled.
- All burners have been tested for proper operation.
- **FOR INSTALLER ONLY**—Check and/or adjust the broil and oven burner flames as described on pages 23-24 in this manual.

Installation instructions

Adjusting the oven burner air adjustment shutters

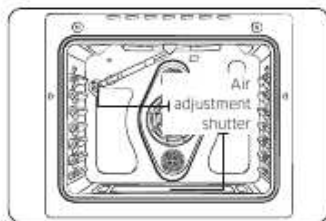

All oven burners have an air adjustment shutter. The purpose of the shutter is to regulate the flow of air to the flames. Properly adjusted flames should burn steadily with approximately 1-in of blue cone. The flames should never extend past the edge of the burner baffles. Even though these are preset at the factory, they should be checked and, if needed, adjusted periodically to ensure efficient operation.

To check and adjust the oven burner air adjustment shutters:

1. Open the oven door.
2. Remove the oven racks.
3. Remove the oven floor.
4. Press the **Bake** pad, then the **START/SET** pad.
5. After the oven has lit, visually check the flames coming out of the upper and lower burners. If adjustment is needed, carefully adjust the air adjustment shutters.

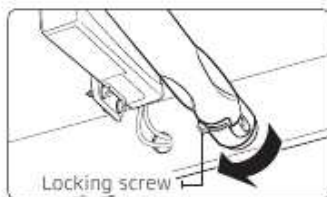

The shutters are located at the base of the burner manifolds near the back oven wall. To adjust the shutter, loosen the locking screw and rotate the shutter towards the open or closed position as needed. If flames are lifting off the burner ports, gradually reduce the air shutter opening until the flames are stabilized. If flames are too yellow and/or too large, gradually increase the air shutter opening until the flames have approximately a 1-in blue cone.

NOTE

If the range is set up for natural gas, the flames should burn with no yellow tipping. If the range is set up for LP gas, small yellow tips at the end of the cones are normal.

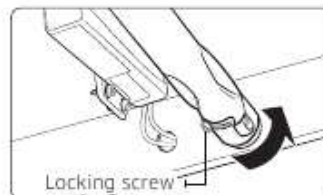

After the flames are adjusted properly, shut off the oven, retighten the locking screws, replace the oven bottom and racks, and close the oven door.

To adjust flame low setting

Identify which burner is exhibiting too high or too low of simmer rate via manifold panel graphics.

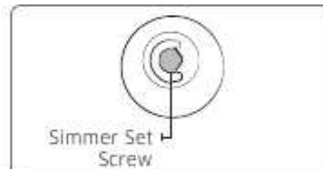

1. Rotate a knob to "LO" position and remove the knob from the valve shaft while the flame is lit.

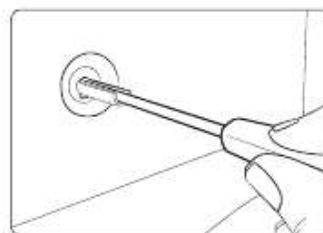

2. Carefully push the screwdriver into the C channel of the valve, until it hits the simmer set screw. Make sure the screwdriver flathead is seated into the set screw groove.
3. Rotate valve set screw clockwise to decrease "LO" setting flame output, or rotate set screw counter clockwise to increase "LO" setting flame output.

Installation instructions

Memo

WARNING

1. Do not completely remove the valve set screw from the valve stem. The valve set screw is an integral part of the gas valve assembly. Removing the valve set screw will cause gas to leak.
2. After adjusting the valve set screw, inspect the assembly for gas leaks.

SAMSUNG



Scan this with your smartphone

Scan the QR code* or visit
www.samsung.com/spsn
to view our helpful
How-to Videos and Live Shows
*Requires reader to be installed on your
smartphone

QUESTIONS OR COMMENTS?

COUNTRY	CALL	OR VISIT US ONLINE AT
U.S.A Consumer Electronics	1-800-SAMSUNG (726-7864)	www.samsung.com/us/support
CANADA	1-800-SAMSUNG (726-7864)	www.samsung.com/ca/support (English) www.samsung.com/ca_fr/support (French)



DG68-00906A-03