



48" Vanity Top Assembly Instructions

James Martin Vanities Company always recommends you consult and/or hire a professional contractor when installing your vanity cabinet and top.

3cm/1.18"
Countertop

Wood Backsplash(Optional) is shipped attached to the back side of the vanity cabinet.

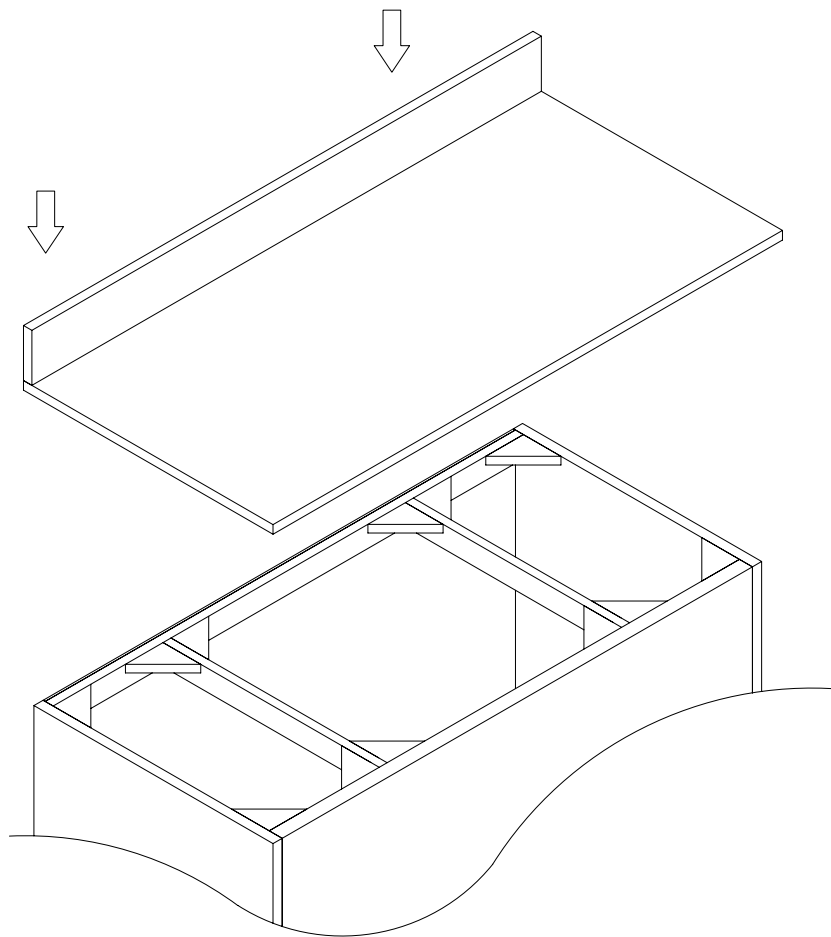

Please consult your professional contractor regarding the best Polyurethane Construction Adhesive to attach the Countertop to the vanity cabinet-and backsplash, if desired.

Please Note: The vanity cabinet's back panel is shipped un-cut, to allow for a variety of plumbing installation options.