

Dia Trim Series

Dia Trim Series with TA-10 Flow Control Spindle & T-12A Cap Assembly
Installation & Operation Instructions

Model Numbers

TRIM ONLY

- 3500-CYL-B-TRM**
Shower Valve Trim
- 3501-CYL-B-TRM**
Shower Trim
- 3502-CYL-B-TRM**
Tub/Shower Trim
- 3503-H321-V-CYL-B-TRM**
Hand Shower Trim
- 3505-H321-V-CYL-B-TRM**
Shower/Hand Shower Trim
- 3506-H321-V-CYL-B-TRM**
Tub/Shower/Hand Shower Trim
- 3520-B-TRM**
Shower Valve Trim
- 3521-B-TRM**
Shower Trim
- 3522-B-TRM**
Tub/Shower Trim
- 3530-B-TRM**
Shower Valve Trim
- 3531-B-TRM**
Shower Trim
- 3532-B-TRM**
Tub/Shower Trim

TRIM, TA-10, T-12A

- 3500CYLBTRMTC**
Shower Valve Trim
- 3501CYLBTRMTC**
Shower Trim
- 3502CYLBTRMTC**
Tub/Shower Trim
- 3503H321CYLBTRMTC**
Hand Shower Trim
- 3505H321CYLBTRMTC**
Shower/Hand Shower Trim
- 3506H321CYLBTRMTC**
Tub/Shower/Hand Shower Trim
- 3520BTRMTC**
Shower Valve Trim
- 3521BTRMTC**
Shower Trim
- 3522BTRMTC**
Tub/Shower Trim
- 3530BTRMTC**
Shower Valve Trim
- 3531BTRMTC**
Shower Trim
- 3532BTRMTC**
Tub/Shower Trim

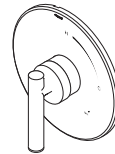
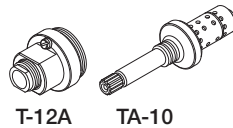

3500-CYL-B-TRM
3500CYLBTRMTC

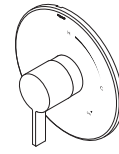

3520-B-TRM
3520BTRMTC

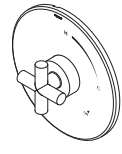

3530-B-TRM
3530BTRMTC



3501-CYL-B-TRM
3501CYLBTRMTC



3521-B-TRM
3521BTRMTC



3531-B-TRM
3531BTRMTC



3502-CYL-B-TRM
3502CYLBTRMTC



3522-B-TRM
3522BTRMTC



3532-B-TRM
3532BTRMTC



3503-H321-V-CYL-B-TRM
3503H321CYLBTRMTC



3505-H321-V-CYL-B-TRM
3505H321CYLBTRMTC



3506-H321-V-CYL-B-TRM
3506H321CYLBTRMTC

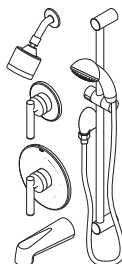
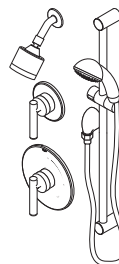
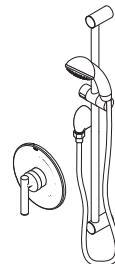

Compliance

- ASME A112.18.1/CSA B125.1



Warranty

Limited Lifetime - to the original end purchaser in consumer/residential installations.

5 Years - for industrial/commercial installations.

Refer to www.symmons.com/warranty for complete warranty information.

Go to www.symmons.com/register to register your Symmons product.

1. Recommended Tools

FIGURE 1

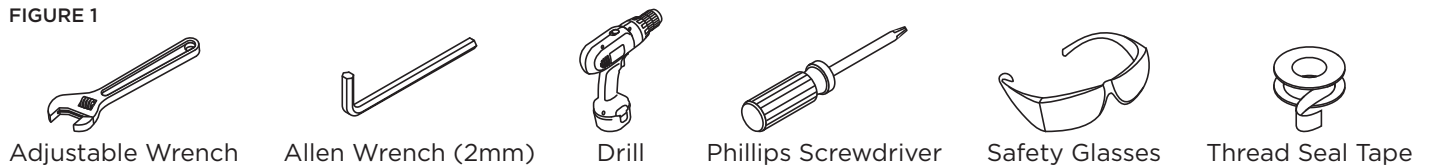

2. Dimensions

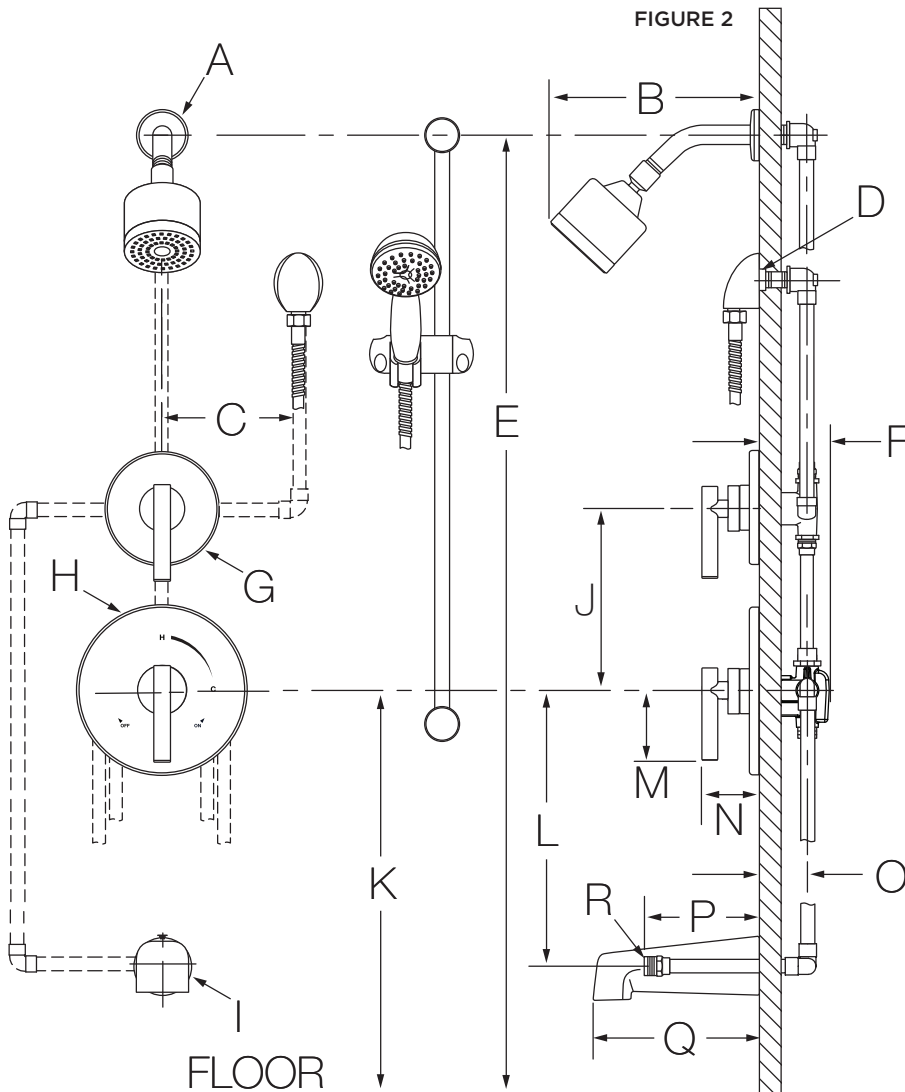

Measurements	
A	Ø 2-1/2", 64 mm
B	6-3/4", 171 mm
C	6", 152 mm
D	Male 1/2-14 NPT thread must be recessed 1/4" (6 mm) from finished wall
E	Ref. 77", 1956 mm
F	3-1/2", 89 mm
G	Ø 5", 127 mm
H	Ø 7-1/2", 191 mm
I	Ø 2-1/2", 64 mm
J	Ref. 10", 254 mm
K	3500, 3501, 3503, 3505: Ref. 42", 1067 mm 3502, 3506: Ref. 32", 813 mm
L	Ref. 12", 305 mm
M	3", 76 mm
N	2-7/8", 73 mm
O	Rough-in 2-3/8" ± 1/2", 60 mm ± 13 mm
P	5-1/4", 133 mm
Q	7", 178 mm
R	Male 1/2-14 NPT thread must protrude 4-7/16" (113 mm) from finished wall
S	2-7/8", 73 mm
T	3", 76 mm
U	2-7/8", 73 mm
V	1-3/8", 35 mm
W	Ø 2-1/2", 64 mm
X	Male 1/2-14 NPT thread must protrude 5-1/2" (140 mm) from finished wall
Y	5-1/2", 140 mm
Z	7", 178 mm

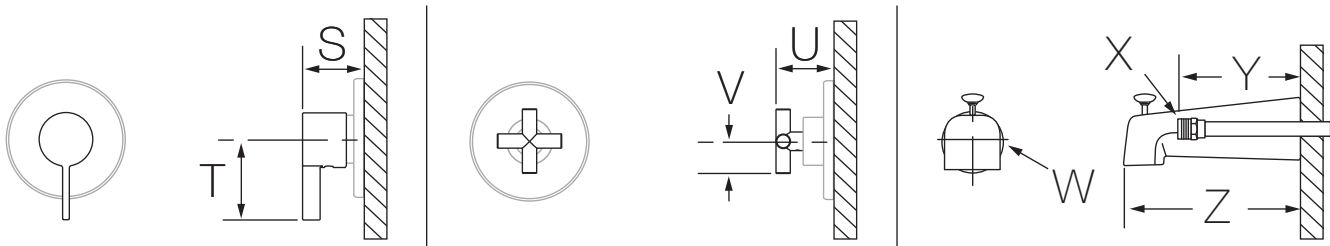

Notes:

- 1) Valve body and piping not included and shown as reference only.
- 2) Plaster shield (p/n T-176) for dry wall, plaster or other type walls 1/2" or greater.
- 3) All dimensions measured from nominal rough-in (see O as reference).
- 4) Dimensions subject to change without notice.

3. Parts Breakdown (Model Numbers Ending in TRMTC)

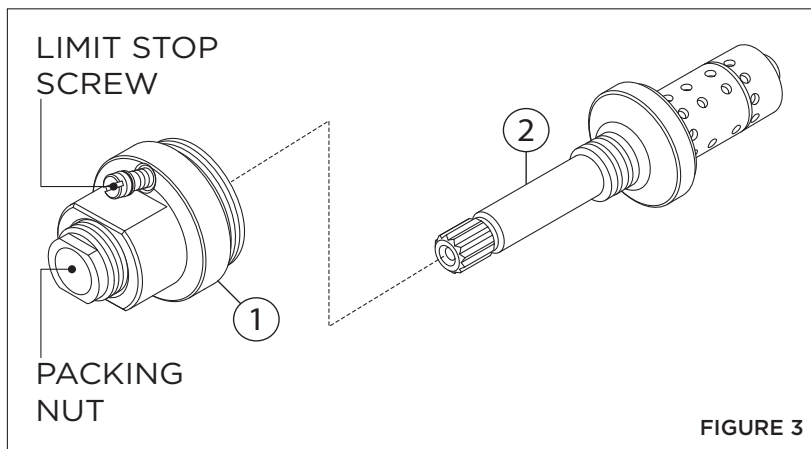

FIGURE 3

Replacement Parts		
Item	Description	Part Number
1	Cap Assy.	T-12A
2	Flow Control Spindle	TA-10

IMPORTANT: Model numbers ending in **TRMTC** coordinate with Temptrol pressure balancing valves ordered with Test Cap. The Test Cap is used to allow pressurization of system. **Do not** remove test cap from valve during wall construction, installation of valve or pressurization of system.

⚠ WARNINGS:

1. Do not expose valve with test cap to heat for longer than 2 minutes when soldering copper tubing. Doing so may damage the internal components of the valve and will void the product warranty.
2. Ensure test cap is **tightened securely** after soldering valve body.

4. Installation - Remove Test Cap (Model Numbers Ending in TRMTC)

Flow control spindle (TA-10) and cap assembly (T-12A) will come factory assembled for all model numbers ending in **TRMTC**. When ready to remove Test Cap and install trim, follow the instructions below:

- 1) Check for leaks around the valve assembly and all pipe fittings.
- 2) Remove test cap from valve (FIGURE 4.1).
- 3) If system is dirty, flush valve.
- 4) Thread flow control spindle and cap assembly into valve body. Turn clockwise to secure to valve (FIGURE 4.2).

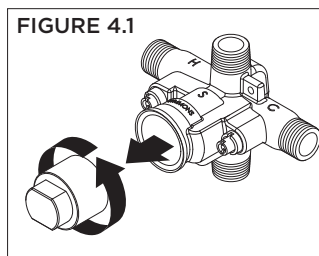

FIGURE 4.1

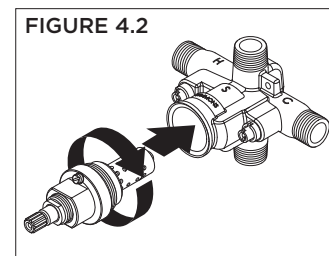

FIGURE 4.2

5. Installation - Adjust Packing Nut (Model Numbers Ending in TRMTC)

- 1) Turn hot and cold supplies on. Valve will not operate unless both hot and cold water supply pressures are on.
- 2) Place handle over flow control spindle.
- 3) Tighten packing nut for positive frictional resistance as handle is rotated from shut-off position across adjustment range.

6. Installation - Setting Limit Stop Screw (Model Numbers Ending in TRMTC)

The temperature limit stop screw limits valve handle from being turned to maximum position resulting in excessive hot water discharge temperatures.

⚠ WARNING: Failure to adjust limit stop screw properly may result in serious scalding.

- 1) Turn hot and cold supplies on. Valve will not operate unless both hot and cold water supply pressures are on.
- 2) Place handle on flow control spindle and open valve to maximum desired temperature.
- 3) Turn limit stop screw clockwise until it seats.

7. Parts Breakdown

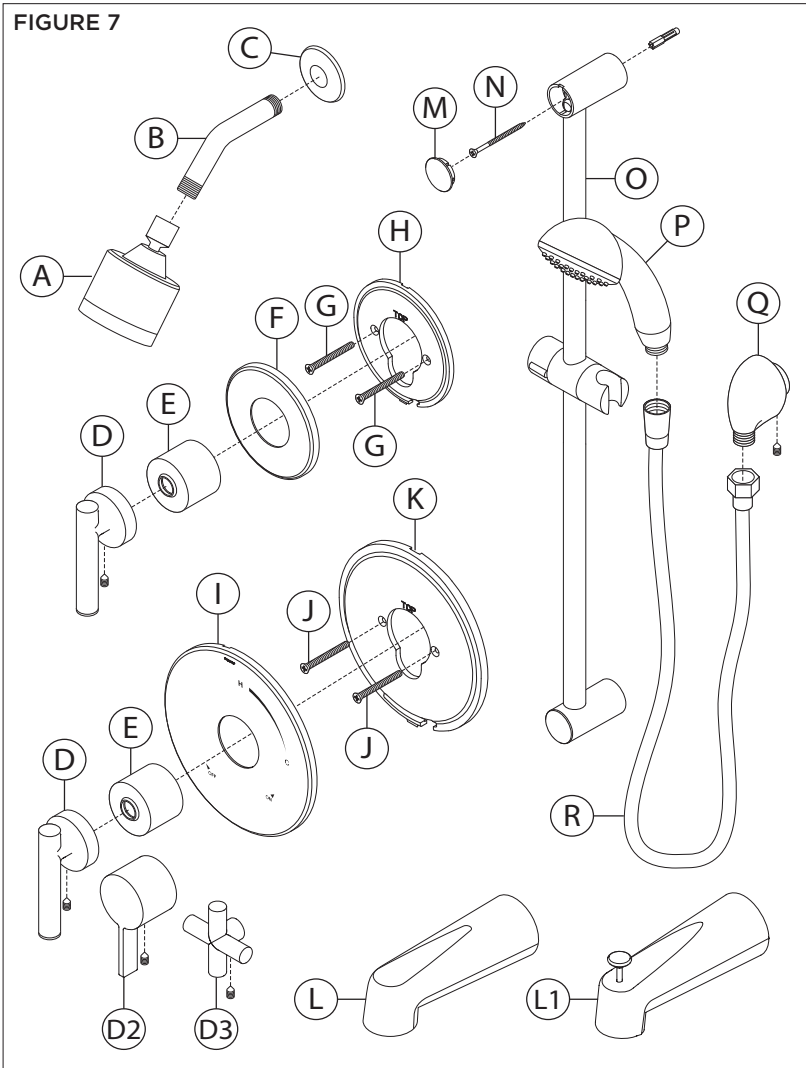

Replacement Parts		
Item	Description	Part Number
A	Showerhead	352SH
B	Shower Arm	300S
C	Flange	300S
D	Standard Handle	T-242A
D1	Blade Handle	RTS-090
D2	Cross Handle	RTS-091
E	Dome Cover	T-19/20
F	Diverter Escutcheon	T-416A
G	Screws	
H	Mounting Plate	
I	Shower Escutcheon	Brass: RTS-009
J	Screws	Plastic: RTS-010
K	Mounting Plate	RTS-010
L	Tub Spout	067
L1	Diverter Tub Spout	352TS
M	Slide Bar Assembly	RA-009
N		
O		
P	Hand Shower	EF-100
Q	Wall Elbow	EF-105
R	60" Hose	RTS-045

Notes:

- 1) Append appropriate suffix for premium finish.
- 2) Append appropriate flow rate to showerhead or hand shower for low flow.
- 3) Apply a bead of silicone around the perimeter of all shower trim installed flush to the finished wall. Leave opening on bottom of escutcheons for weep hole.
- 4) Apply plumber tape to all threaded connections.



*Order in-line vacuum breaker (EF-109) for hand shower systems without dual checks.

8. Installation - Shower Valve Trim

- 1) Secure large mounting plate to Temptrol pressure balancing valve using mounting screws (FIGURE 8.1).
- 2) Secure large shower escutcheon to mounting plate. Tabs should snap in place (FIGURE 8.2).
- 3) Install dome cover by turning clockwise (FIGURE 8.3).
- 4) Install handle to shower valve. Secure with set screw (FIGURE 8.4).

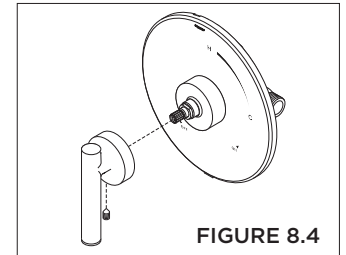
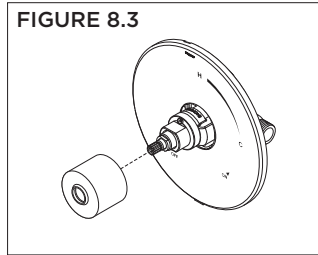
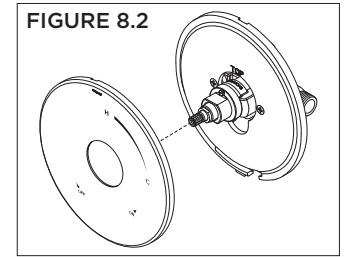
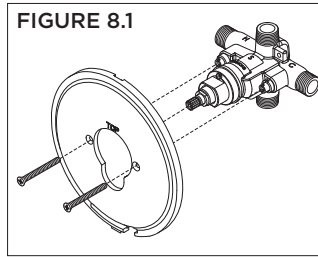

9. Installation - Diverter Valve Trim

- 1) Secure small mounting plate to Symmons diverter valve using mounting screws (FIGURE 9.1).
- 2) Secure small diverter escutcheon to mounting plate. Tabs should snap in place (FIGURE 9.2).
- 3) Install dome cover by turning clockwise (FIGURE 9.3).
- 4) Install handle to diverter valve. Secure with set screw (FIGURE 9.4).

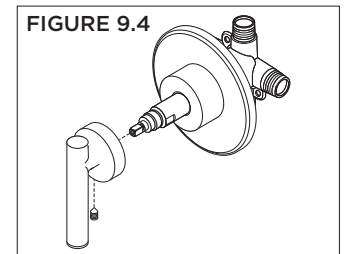
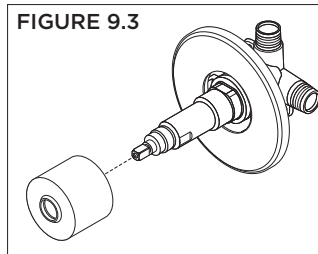
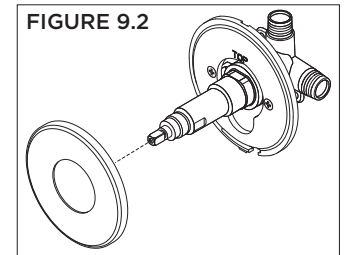
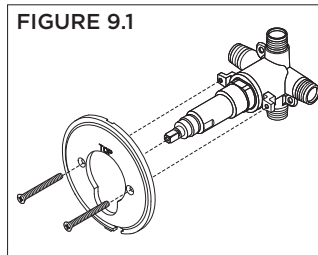

10. Installation - Showerhead & Tub Spout

- 1) Attach arm and flange to shower pipe. Turn clockwise to tighten (FIGURE 10.1).
- 2) Install showerhead to shower arm. Turn clockwise to tighten (FIGURE 10.2).
- 3) Install tub spout to stub out pipe. Turn clockwise to tighten (FIGURE 10.3).

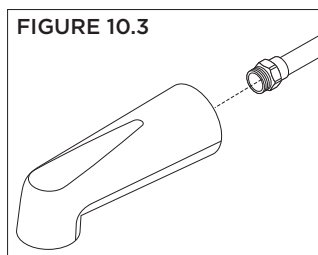
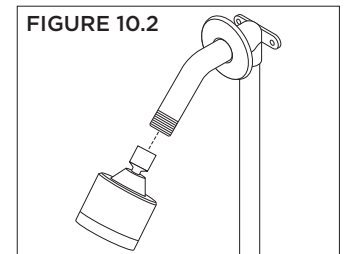
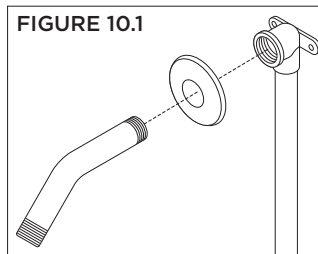

11. Installation - Slide Bar Assembly

1a) **Dry Wall Option:** Remove upper and lower caps from slide bar brackets. Place slide bar into desired position. Using brackets as a guide, carefully drill $3/16''$ holes into wall. Remove slide bar and install anchors.

Note: Slide bar holes and bracket holes must be aligned before drilling. Before drilling bottom hole, make sure slide bar is plumb (FIGURE 11.1A).

1b) **Stud Option:** Remove upper and lower caps from slide bar brackets. Place slide bar into desired position. Using brackets as a guide, carefully drill $1/8''$ pilot holes into stud.

Note: Slide bar holes and bracket holes must be aligned before drilling. Before drilling bottom hole, make sure slide bar is plumb (FIGURE 11.1B).

2) With slide bar in position, secure to wall using screws. Replace upper and lower caps onto slide bar brackets (FIGURE 11.2).

3) Install wall elbow to stub out pipe. Tighten set screw to secure (FIGURE 11.3).

4) Attach small end of hand shower hose to wall elbow. Turn clockwise to tighten (FIGURE 11.4).

5) Attach large end of hand shower hose to hand shower wand. Turn clockwise to tighten (FIGURE 11.5).

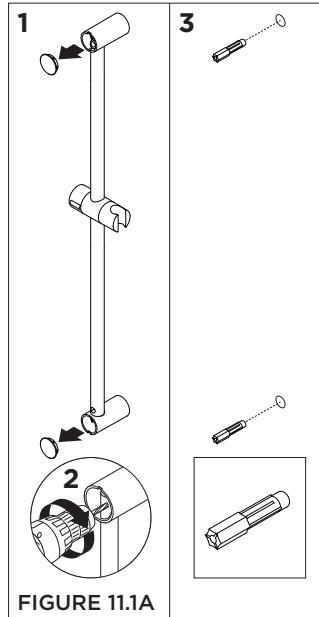

FIGURE 11.1A

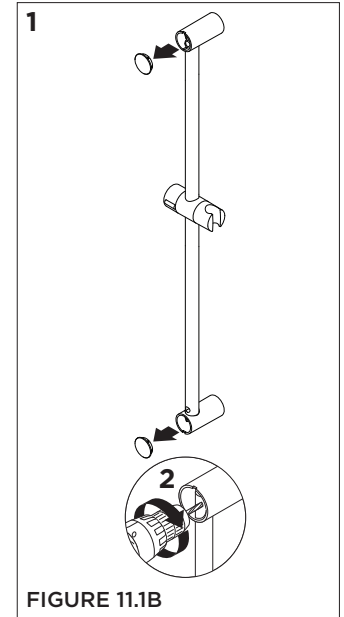

FIGURE 11.1B

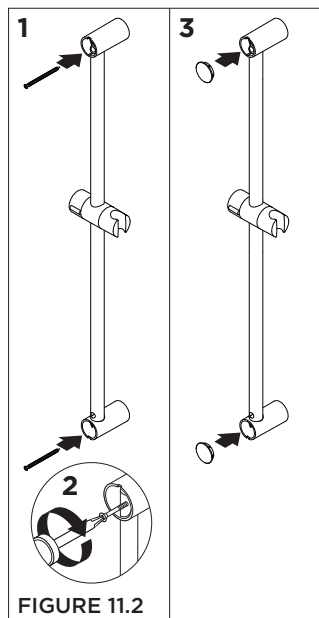

FIGURE 11.2

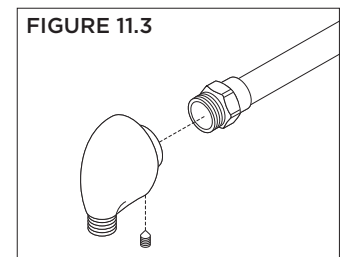

FIGURE 11.3

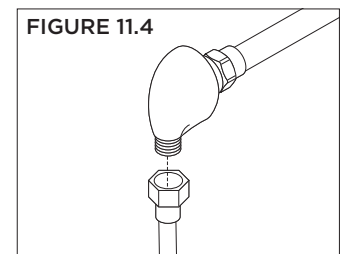

FIGURE 11.4

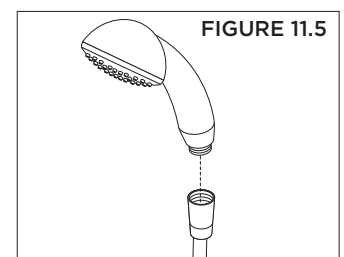
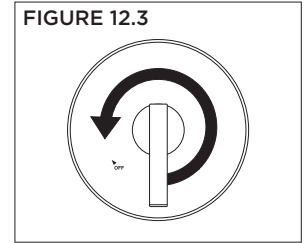
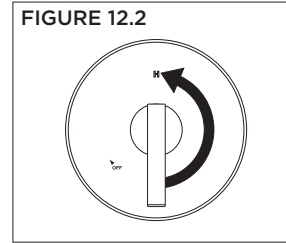
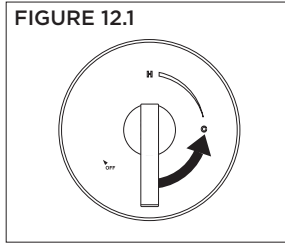

FIGURE 11.5

12. Operation (Temperature Control)

- 1) Turn shower handle counter-clockwise approximately 1/4 turn to put valve in cold position (FIGURE 12.1).
- 2) Turn shower handle counter-clockwise approximately 1/2 turn to put valve in warm position (FIGURE 12.2).
- 3) Turn shower handle counter-clockwise approximately 3/4 turn to put valve in hot position (FIGURE 12.3).



13. Operation (Dual Outlet Diverter Control)

Note: Additional handle positions for same output are illustrated.

- 1) Cartridge is factory set to divert to function 1 (FIGURE 13.1).
- 2) Turn handle to position 2 to divert to function 2 (FIGURE 13.2).
- 3) Turn handle to position 3 to share functions 1 and 2 (FIGURE 13.3).

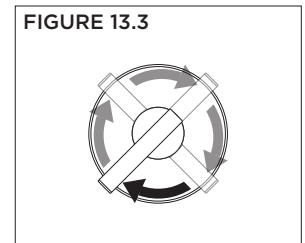
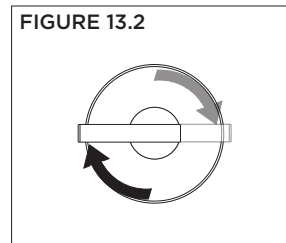
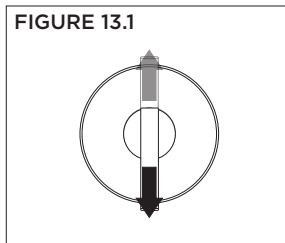

14. Operation (Triple Outlet Diverter Control)

- 1) Cartridge is factory set to divert to function 1 (FIGURE 14.1).
- 2) Turn handle to position 2 to divert to function 2 (FIGURE 14.2).
- 3) Turn handle to position 3 to divert to function 3 (FIGURE 14.3).
- 4) Turn handle to position 4 to share functions 2 and 3 (FIGURE 14.4).
- 5) Turn handle to position 5 to share functions 1 and 3 (FIGURE 14.5).
- 6) Turn handle to position 6 to share functions 1 and 2 (FIGURE 14.6).

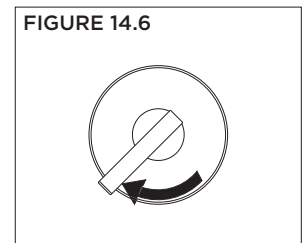
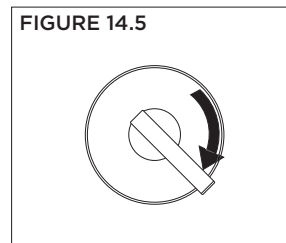
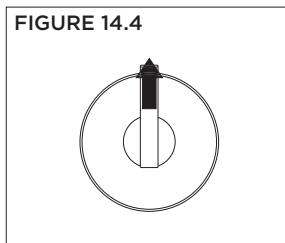
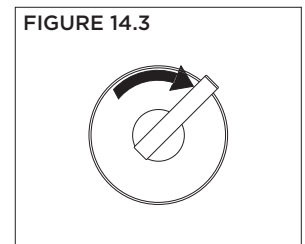
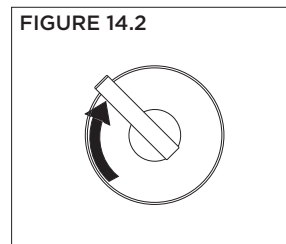
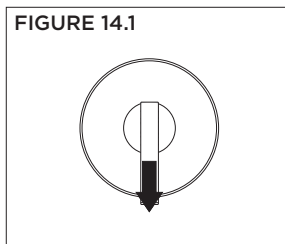

15. Troubleshooting Chart

Problem	Cause	Solution
Finish is spotting.	Elements in water supply may cause water staining on finish.	Clean finished trim area with a soft cloth using mild soap and water or a non-abrasive cleaner and then quickly rinse with water.

 **WARNING:** This product can expose you to chemicals including lead, which is known to the state of California to cause cancer, birth defects, or other reproductive harm. For more information, go to www.P65Warnings.ca.gov.