

Product Specification - Vanity Sink Base Cabinets **Fully Assembled • Ready to Install**

Brand: Continental Cabinets
 Product Description: Vanity Sink Base Cabinets
 Model #: KVSB24, KVSB30, KVSB36, KVDB12
 Toekick Accessory: KATKX

Vanity Sink Base Widths: 24", 30" and 36"
 Vanity Drawer Base Width: 12"
 Height (All): 34½"
 Depth (All): 21"

Overlays & Reveals

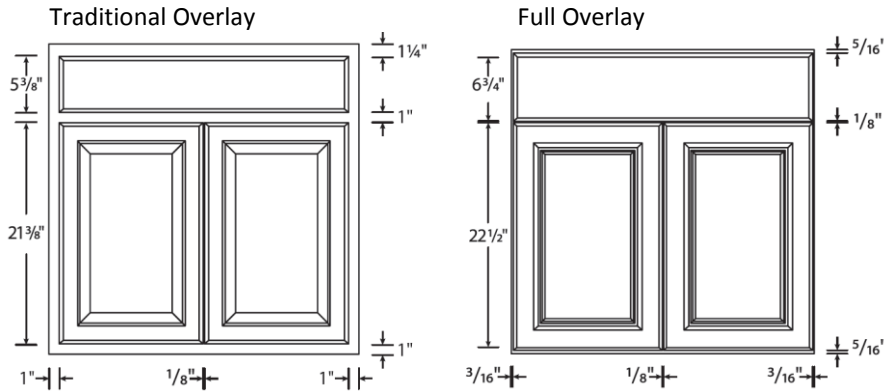

Toekick Dimensions

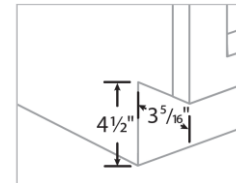

Door Styles

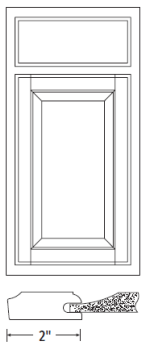

HAMILTON

Finishes	Details
Café (COG)	Mortise and Tenon Construction
Hickory (NHK)	Traditional Overlay
Oak (MO)	Raised Panel

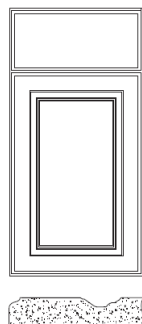

HAMILTON RTF

Finish	Details
White Rigid Thermofoil (RTF) (SW)	Routed MDF Full Overlay Raised Panel

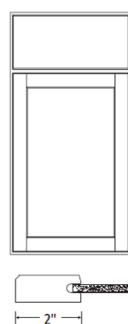

ANDOVER

Finish	Details
Java (SJM)	Mortise and Tenon Construction Full Overlay Flat Panel Shaker

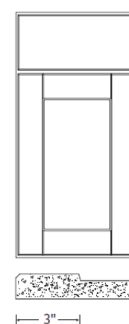

ANDOVER RTF

Finish	Details
White (SSW) Grey (SDV) Rigid Thermofoil (RTF)	MDF Full Overlay Flat Panel Shaker

Specification

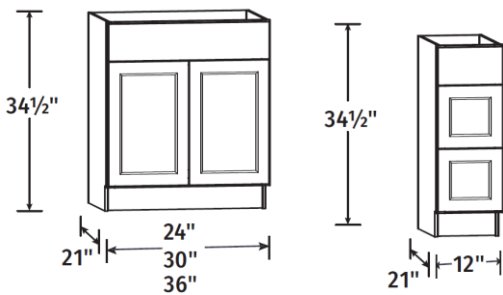

- 3/4" thick face frame, 1½" wide material with pocket screwed construction
- 3/8" hardboard full back panel
- 3/8" bottom panel, fully encapsulated engineered wood
- 1/2" engineered wood side panels with cabinet matching laminate exterior
- Double door cabinets allow for full-access, no center stile
- Natural maple laminate finished interiors
- Fully concealed, adjustable, self-closing hinges
- KVSB24, KVSB30 and KVSB36 – Do not include a drawer
- KVDB12 includes three drawers with 4-sided hardwood drawer box, encapsulated drawer bottoms and ball bearing drawer glides
- Standard toe kick, KATKX, sold separately



Meets HUD Minimum Property Standards