



BRADFORD WHITE[®]
W A T E R H E A T E R S

PV Series
Power Vent Gas Water Heaters



SERVICE

MANUAL

Troubleshooting Guide and Instructions for Service

(To be performed ONLY by
qualified service providers)

Models Covered by This Manual:

Through-The-Wall Models:

RG1PV40S*(N,X)

RG1PV50S*(N,X)

RG1PV55H*(N,X)

RG2PV40T*(N,X)

RG2PV50H*(N,X)

RG2PV50T*(N,X)

RG2PV75H*(N,X)

RG2PV60T*(N,X)

LG1PV55H78*(N,X)

LG2PV50H65*(N,X)

LG2PV75H76*(N,X)

(* Denotes Warranty Years)



As required by the state of California Proposition 65.

The Bradford White

PV Series

Power Vent Gas Water Heaters

Table of Contents

	<u>Page</u>	<u>PV Service Procedure</u>
Introduction	4	---
How to Use This Manual	5	---
Tools Required for Service	5	---
Specifications	6	---
Control Timings	10	---
Sequence of Operation	11	---
Troubleshooting	15	---
Burner Inspection, Cleaning & Replacement	17	I
Pilot Testing, Cleaning & Replacement	19	II
Pressure Switch Testing & Replacement	20	III
Blower Testing & Replacement	22	IV
Blower Temperature Switch Testing & Replacement	24	V
Gas Control Testing & Replacement	26	VI
Flammable Vapor Device Testing and Replacement	33	VII
Safety Circuit Voltage Trace	34	VIII
115 VAC Circuit Trace	35	IX
Dip Tube Inspection & Replacement	36	X
Anode Inspection & Replacement	37	XI
Flue Baffle Inspection & Replacement	38	XII
Inner Door Removal, Inspection & Replacement	39	XIII
Glossary of Terms	43	---
Parts List	44	---

PV Series

WARNING: If the information in these instructions is not followed exactly, a fire or explosion may result causing property damage, personal injury, or death.

FOR YOUR SAFETY

Do not store or use gasoline or other flammable, combustible, or corrosive vapors and liquids in the vicinity of this or any other appliance.

WHAT TO DO IF YOU SMELL GAS!

- Do not try to light any appliance.
- Do not touch any electrical switch; do not use any phone in your building.
- Immediately call your gas supplier from a neighbor's phone. Follow the gas supplier's instructions.
- If you cannot reach your gas supplier, call the fire department.

Installation and service must be performed by a qualified installer, service agency or the gas supplier.

⚠ DANGER

Do not store or use gasoline or other flammable, combustible, or corrosive vapors and liquids in the vicinity of this or any other appliance.

IMPORTANT

Before proceeding, please inspect the water heater and its components for possible damage. DO NOT install any water heater with damaged components. If damage is evident then please contact the supplier where the water heater was purchased or the manufacturer listed on the rating plate for replacement parts.

⚠ WARNING

Water heaters are heat producing appliances. To avoid damage or injury, do not store materials against the water heater or vent-air intake system. Use proper care to avoid unnecessary contact (especially by children) with the water heater and vent-air intake components. **UNDER NO CIRCUMSTANCES MUST FLAMMABLE MATERIALS, SUCH AS GASOLINE OR PAINT THINNER BE USED OR STORED IN THE VICINITY OF THIS WATER HEATER, VENT-AIR INTAKE SYSTEM OR IN ANY LOCATION FROM WHICH FUMES COULD REACH THE WATER HEATER OR VENT-AIR INTAKE SYSTEM**

⚠ CAUTION

If sweat fittings are to be used **DO NOT** apply heat to the nipples on top of the water heater. Sweat the tubing to the adapter before fitting the adapter to the water connections. It is imperative that heat is not applied to the nipples containing a plastic liner.

⚠ WARNING

Hydrogen gas can be produced in an operating water heater that has not had water drawn from the tank for a long period of time (generally two weeks or more). Hydrogen gas is extremely flammable. To prevent the possibility of injury under these conditions, we recommend the hot water faucet to be open for several minutes at the kitchen sink before you use any electrical appliance which is connected to the hot water system. If hydrogen is present, there will be an unusual sound such as air escaping through the pipes as hot water begins to flow. Do not smoke or have open flame near the faucet at the time it is open.

⚠ WARNING

DO NOT ATTEMPT TO LIGHT ANY GAS APPLIANCE IF YOU ARE NOT CERTAIN OF THE FOLLOWING:

- Liquefied petroleum gases/propane gas and natural gas have an odorant added by the gas supplier that aids in the detection of the gas.
- Most people recognize this odor as a "sulfur" or "rotten egg" smell.
- Other conditions, such as "odorant fade" can cause the odorant to diminish in intensity, or "fade", and not be as readily detectable.
- If you have a diminished sense of smell, or are in any way unsure of the presence of gas, immediately contact your gas supplier from a neighbor's telephone.

Gas detectors are available. Contact your gas supplier, or plumbing professional, for more information.

⚠ WARNING

FAILURE TO INSTALL AND MAINTAIN A NEW, LISTED 3/4" X 3/4" TEMPERATURE AND PRESSURE RELIEF VALVE WILL RELEASE THE MANUFACTURER FROM ANY CLAIM THAT MIGHT RESULT FROM EXCESSIVE TEMPERATURE AND PRESSURES.

⚠ CAUTION

Turn off or disconnect the electrical power supply to the water heater before servicing. Label all wires prior to disconnection when servicing controls. Wiring errors can cause improper and dangerous operation. Verify proper operation after servicing.

PV Series

Introduction

The new Bradford White RG1PV & RG2PV water heaters are designed to provide reliable performance with enhanced standard features. New design features include reliable spark to pilot ignition system, enhanced diagnostics, simplified servicing, quiet operation, additional vent lengths, and Bradford White Defender Safety System® (not available on all models).

Spark to Pilot Ignition System - employing the spark to pilot ignition system promotes reliable and consistent pilot and main burner ignitions to provide hot water on demand.

Integrated Immersion Thermostat/Gas Control Valve with LED - was developed for ease of troubleshooting by providing simple diagnostic codes to pinpoint an installation or component performance issue.

Powerful Blower - will eliminate problems with difficult venting situations.

Quiet and Cool Blower Operation - blower noise is significantly reduced for both interior and exterior environments. Cooler operation increases blower life by reducing bearing wear and noise.

Rugged Wiring Connections - receptacle type connections promote error free wiring.

Increased Vent Lengths - increased venting performance is achieved while maintaining Energy Factor & FHR (not available on all models) performance.

The RG1PV & RG2PV water heaters use a combustion system where flue gases are combined with dilution air to reduce the flue gas temperature in the blower. The diluted flue gases are evacuated to the exterior through low temperature vent materials. The gas control maintains water temperature, ignition sequence and regulates gas flow. A safety circuit consisting of a pressure switch and blower temperature switch verifies proper conditions exist for safe and reliable operation. If a situation outside of normal operating parameters exists, the gas control diagnostic LED will flash a code to positively identify an operational issue.

This service manual is designed to facilitate problem diagnosis and enhance service efficiency.

Please read the service manual completely before attempting service on this new series of power vent models.

How the Safety System Works

During normal operation, air for combustion is drawn into the water heater through the opening in the jacket. This air travels down and around the combustion chamber and enters through holes in the very bottom of the corrosion-resistant combustion chamber. The air then travels up through the oriented flame arrestor plate louvers, where the velocity of air is increased and its direction altered. The air then mixes in a normal manner with supplied gas and is efficiently combusted, producing low NOx emissions.

In the unlikely event trace amounts of flammable vapors are present in the air flowing into the combustion chamber, the vapors are harmlessly ignited by the burner. If flammable vapors are in sufficient quantity to prevent normal combustion, the flammable vapor sensor recognizes this and shuts down the pilot and main burner. Should the flammable vapor continue to burn, the flame arrestor plate prevents the flames from traveling backwards and igniting vapors outside of the combustion chamber. This feature is only on models with inputs less than or equal to 75,000 BTU/hr.

It is intended for this manual to be used by qualified service personnel for the primary purpose of troubleshooting and repair of the Bradford White PV Series water heaters. Understanding the sequence of operation section of this manual will contribute greatly to troubleshooting the water heater.

The Resideo WV4462A Electronic Gas Control will display error codes in the event of abnormal operation. Error codes are listed in the troubleshooting chart beginning on page 15 of this service manual. The troubleshooting chart will also indicate the probable cause for the error code and direct the service professional to a service procedure to properly diagnose the abnormal operation.

In some difficult to diagnose conditions, it may be necessary to isolate the heater from the vent system to determine the problem.

Contact the Bradford White technical support group immediately if diagnosis cannot be made using the methods described in this service manual.

Tools Required for Service

Manometer:	A liquid "U" tube type or a digital (magnahelic) type can be used. This device is used to measure gas and/or air pressure and vacuum.
Multi-Meter:	A digital type is strongly recommended. This device is used to measure electrical values. The meter you select must have the capability to measure volts AC, volts DC, Amps, micro-amps and ohms.
Electronic Probes:	In some cases, standard multi-meter probes will damage or simply not be effective to obtain certain voltage and ohm readings. It will be necessary to have special electronic "pin" type multi-meter probes. These probes are available at most electronic wholesale outlets.
Thermometer:	Used to measure water temperature. An accurate thermometer is recommended.
Water Pressure Gage:	Used to measure water supply pressure. Also used to determine tank pressure by adapting to the drain valve of the heater.
Various Hand Tools:	Pipe wrench, channel locks, open end wrenches (3/8", 7/16", 1/2"), 12" crescent wrench, allen wrench set, screw drivers (common & Phillip's), 1/4" nut driver, pliers (common & needle nose), socket set, side cutters, wire cutters, wire strippers, wire crimpers, torpedo level, small shop vac, step ladder, flashlight and 5 gallon pail.

PV Series

Specifications

Power supply	Dedicated 115 VAC, 60 Hz, 15A.
Gas Supply Pipe	Minimum 1/2" NPT (schedule 40 black iron pipe recommended).
Approved Gas Type	Natural Gas or Propane, unit must match gas type supplied.
Gas Pressure	5.0" W.C. min. for Natural Gas, 11.0" W.C. min. for Propane, 14.0" W.C. maximum (Natural Gas & Propane).
Venting System	Power vent through the wall or vertical through the roof.
Approved Vent Materials	PVC, CPVC or ABS.
Minimum Clearance for Servicing	18" from top, 24" from front, 4" sides and rear.
Water Supply Pressure	150 PSI maximum allowable working pressure. Check local codes for supply pressure.
Gas Control ECO Limit	Residential 188°F (87°C), Commercial 199°F (93°C).
Residential Temperature Set Point Range	60°F (16°C) to 160°F (71°C) (approximate temperatures).
Commercial Temperature Set Point Range	80°F (27°C) to 180°F (82°C) (approximate temperatures).
Blower Temperature Switch	Normally closed, opens @ 155°F (68°C), auto reset @ approximately 135°F (57°C).
Pressure Switch	<p>RG1PV(40,50)S, (R,L)G2PV50H Models: Normally open, closes on vacuum increase @ -.75" W.C.; Opens on vacuum decrease @ -.72" W.C.</p> <p>RG2PV(40,50,60)T: Normally open, closes on vacuum increase @ -.80" W.C.; Opens on vacuum decrease @ -.77" W.C.</p> <p>(R,L)1PV55H Models: Normally open, closes on vacuum increase @ -1.40" W.C.; Opens on vacuum decrease @ -1.37" W.C.</p> <p>(R,L)G2PV75H Models: Normally open, closes on vacuum increase @ -1.25" W.C.; Opens on vacuum decrease @ -1.22" W.C.</p>
Blower	115 VAC, 60 Hz, 3.1 amps, 3000 RPM.

Vent Tables

Venting Specifications for:

RG1PV40S, RG2PV40T
RG1PV50S, RG2PV50T

2" Diameter (5.1 cm) Vent Connector Lengths			
Terminating	# of Elbows	Maximum Straight Length ft. (m)	Minimum Straight Length ft. (m)
Through the Wall	1	45 (16.8)	2 (.6)
Through the Wall	2	40 (15.2)	2 (.6)
Through the Wall	3	35 (13.7)	2 (.6)
Through the Wall	4	30 (12.2)	2 (.6)
Through the Roof	0	50 (18.3)	7 (2.1)
Through the Roof	1	45 (16.8)	7 (2.1)
Through the Roof	2	40 (15.2)	7 (2.1)
Through the Roof	3	35 (10.7)	7 (2.1)
Through the Roof	4	30 (9.2)	7 (2.1)

3" Diameter (10.2 cm) Vent Connector Lengths			
Terminating	# of Elbows	Maximum Straight Length ft. (m)	Minimum Straight Length ft. (m)
Through the Wall	1	115 (35)	10 (3.1)
Through the Wall	2	110 (33.5)	10 (3.1)
Through the Wall	3	105 (32.0)	10 (3.1)
Through the Wall	4	100 (30.5)	10 (3.1)
Through the Wall	5	95 (29.0)	10 (3.1)
Through the Roof	0	120 (36.6)	15 (4.6)
Through the Roof	1	115 (35)	15 (4.6)
Through the Roof	2	110 (33.5)	15 (4.6)
Through the Roof	3	105 (32.0)	15 (4.6)
Through the Roof	4	100 (30.5)	15 (4.6)

Vent Tables

Venting Specifications for:

RG2PV50H
LG2PV50H

3" Diameter (7.6 cm) Vent Connector Lengths			
Terminating	# of Elbows	Maximum Straight Length ft. (m)	Minimum Straight Length ft. (m)
Through the Wall	1	55 (16.8)	2 (.6)
Through the Wall	2	50 (15.2)	2 (.6)
Through the Wall	3	45 (13.7)	2 (.6)
Through the Wall	4	40 (12.2)	2 (.6)
Through the Roof	0	60 (18.3)	7 (2.1)
Through the Roof	1	55 (16.8)	7 (2.1)
Through the Roof	2	50 (15.2)	7 (2.1)
Through the Roof	3	45 (13.7)	7 (2.1)

4" Diameter (10.2 cm) Vent Connector Lengths			
Terminating	# of Elbows	Maximum Straight Length ft. (m)	Minimum Straight Length ft. (m)
Through the Wall	1	175 (53.3)	10 (3.1)
Through the Wall	2	170 (51.8)	10 (3.1)
Through the Wall	3	165 (50.3)	10 (3.1)
Through the Wall	4	160 (48.8)	10 (3.1)
Through the Wall	5	155 (47.2)	10 (3.1)
Through the Roof	0	180 (54.9)	15 (4.6)
Through the Roof	1	175 (53.3)	15 (4.6)
Through the Roof	2	170 (51.8)	15 (4.6)
Through the Roof	3	165 (50.3)	15 (4.6)
Through the Roof	4	160 (48.8)	15 (4.6)

Vent Tables

Venting Specifications for:

RG1PV55H
 RG2PV75H
 LG1PV55H
 LG2PV75H

3" Diameter (7.6 cm) Vent Connector Lengths			
Terminating	# of Elbows	Maximum Straight Length ft. (m)	Minimum Straight Length ft. (m)
Through the Wall	1	45 (13.7)	2 (.6)
Through the Wall	2	40 (12.2)	2 (.6)
Through the Wall	3	35 (10.7)	2 (.6)
Through the Wall	4	30 (9.1)	2 (.6)
Through the Roof	0	50 (15.2)	7 (2.1)
Through the Roof	1	45 (13.7)	7 (2.1)
Through the Roof	2	40 (12.2)	7 (2.1)
Through the Roof	3	35 (10.7)	7 (2.1)

4" Diameter (7.6 cm) Vent Connector Lengths			
Terminating	# of Elbows	Maximum Straight Length ft. (m)	Minimum Straight Length ft. (m)
Through the Wall	1	175 (53.3)	10 (3.1)
Through the Wall	2	170 (51.8)	10 (3.1)
Through the Wall	3	165 (50.3)	10 (3.1)
Through the Wall	4	160 (48.8)	10 (3.1)
Through the Wall	5	155 (47.2)	10 (3.1)
Through the Roof	0	180 (54.9)	15 (4.6)
Through the Roof	1	175 (53.3)	15 (4.6)
Through the Roof	2	170 (51.8)	15 (4.6)
Through the Roof	3	165 (50.3)	15 (4.6)
Through the Roof	4	160 (48.8)	15 (4.6)

Control Timings

<u>Ignition State</u>	<u>Timing</u>
Pre-purge	2 Seconds
Trial for Ignition	90 Seconds
Flame Stabilization Period	3 Seconds
Inter-purge	15 Seconds
Flame Failure Response Time	1.5 Seconds (2 second maximum; 1 second minimum.)
Post-purge	15 Seconds
PS Fault Delay (failed open/close)	Retry after 2 minutes
Soft Lockout	Retry after 5 minutes
ECO Limit Lockout	Indefinite (see page 27)
Verify Resistive Delay	Retry after 2 minutes (repeats 5 times)
Flammable Vapor Sensor/Simulated Resistive Load Lockout	Indefinite (cycle power to restart)
Hardware Error Lockout	Indefinite (self clears if fault clears for at least 15 seconds)

WIRING DIAGRAMS

ALL MODELS (EXCEPT 75 GALLON)

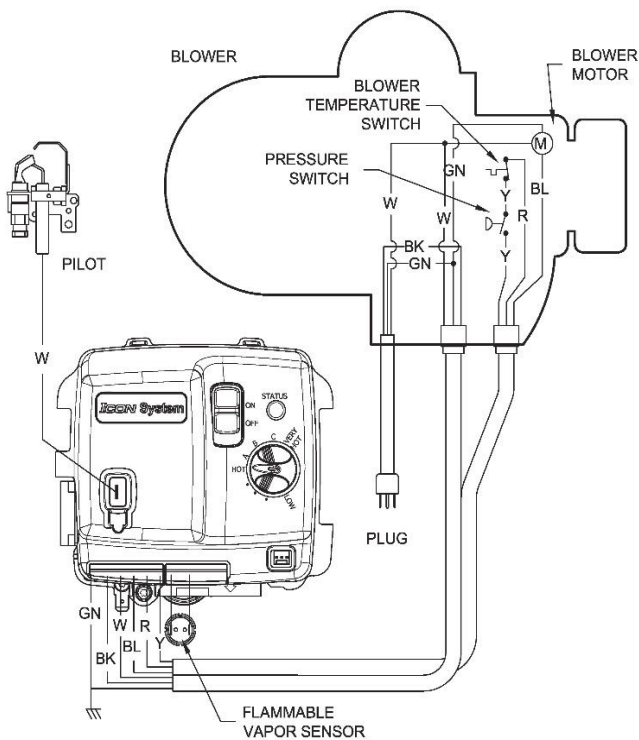

75 GALLON ONLY

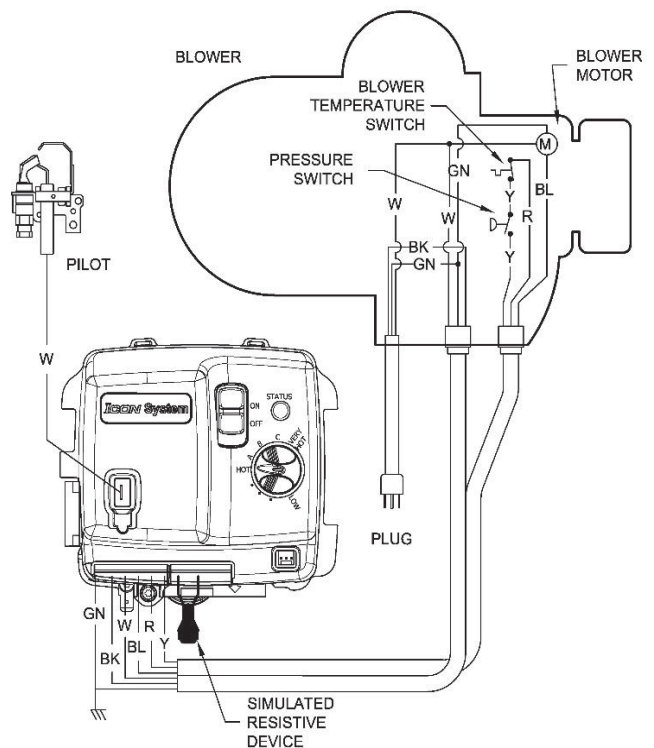

Power Up Sequence

1. Start Up.
Upon power up, the control runs a safe-start check with a typical start-up delay of 5 seconds.
2. Flammable Vapor.
To assure no outputs are energized if the “Flammable Vapor Sensor” (for RG1PV40S, RG1PV50S, RG2PV40T, RG2PV50T, RG2PV 60T, RG2PV50H) or “Simulated Resistive Device” (for RG1PV55H and RG2PV75H) is out of range, the control will test the “Flammable Vapor Sensor” or “Simulated Resistive Device” for proper operating range. If the “Flammable Vapor Sensor” or “Simulative Resistive Device” is out of range, the control LED immediately flashes 7 times with 3 second pause.

Normal Heating Sequence

1. Thermostat calls for heat.
Prior to energizing blower, gas control checks safety circuit to ensure the circuit is open. Normal switch positions in the safety circuit are as follows:
 - a) Pressure switch normally open.
 - b) Blower temperature switch normally closed.

If the safety circuit is closed, the control waits 4 seconds, gas control LED flashes 2 times with 3 second pause. Gas control waits 2 minutes then, blower runs for 30 seconds. This cycle repeats until safety circuit opens.
2. Blower energizes.
3. Pressure switch proves blower/vent system operation.
If the pressure switch does not close within 30 seconds, the control LED flashes 3 times with 3 second pause. The blower runs for 30 seconds every 2 minutes trying to get the pressure switch or blower temperature switch to close. This cycle repeats as long as there is a call for heat.
4. Blower pre-purge period (2 seconds).
5. Trial for pilot ignition (90 seconds).
 - a. The gas control lights the pilot by activating spark igniter and gas flow to pilot burner.
 - b. If flame is not sensed within 90 seconds, igniter and gas flow are deactivated, blower will post purge and control LED flashes 6 times with 3 second pause.
6. Main burner ignition.
After pilot flame is sensed, gas control activates main valve for main burner ignition. The gas control will ignore flame and pressure switch signals for 3 seconds allowing for main burner to stabilize.

Normal Heating Sequence (cont.)

7. Steady state operation.

During steady state operation, the control monitors:

Thermostat temperature sensor-when set point temperature is satisfied, gas valve is shut down and blower will post purge for 15 seconds. Control LED flashes a short flash once every 4 seconds (idle) status code.

Pressure switch / blower temperature switch-if either switch opens, the pilot valve and the main valve are both shut down. The blower continues to run for 30 seconds attempting to close the circuit. The control LED flashes 3 times with 3 second pause.

Flame sensor-if flame is lost, pilot & main valves are shut down, blower runs for 15 seconds. Control attempts to re-light pilot 4 times. If unsuccessful, blower is shut down and control proceeds to 5 minute lockout. Control re-attempts to light pilot starting at normal heating sequence #2.

8. Thermostat satisfies. (Control LED flashing once every 4 seconds).

9. Burner off.

10. Blower post purges (15 seconds).

Abnormal Operation

1. Flammable Vapor Sensor or Simulated Resistive Device Fault:

- a. **If the resistance is greater than 70,000 Ohms**-the gas control immediately turns off all outputs. Control waits and monitors resistance for 30 seconds. If the resistance is greater than 65,000 ohms after 30 seconds, the gas control proceeds to verify resistive delay for 2 minutes and flashes 7 times then once with a three second pause. This process is repeated 5 times until the control either returns to normal operation or proceeds to flammable vapor lockout.
- b. **If the resistance is below 3000 Ohms**-The gas control immediately turns off all outputs and proceeds to flash 8 times then once with three second pause. The error self clears if the resistance returns to normal range for at least 15 seconds.

2. Temperature Sensor Fault:

- a. **Temperature sensor detected open circuit**-The gas control immediately turns off all outputs and proceeds to flash 8 times then, 3 times with 3 second pause. The error self clears if the fault clears for at least 15 seconds.
- b. **Thermal well sensor not reading the same temperature within $\pm 5.5^{\circ}\text{F}$** – The gas control immediately turns off all outputs and proceeds to flash 8

Abnormal Operation (cont.)

times, then 3 times twice with 3 second pauses. The error self clears if the fault clears for at least 15 seconds.

- c. **Water temperature in excess of ECO (energy cut out) limit** -The gas control immediately turns off pilot & main valves and proceeds to flash 4 times with 3 second pause. Blower continues to run until gas control is reset. To reset control, rotate knob of temperature control to the minimum setting for at least 6 seconds before returning to desired temperature setting.
3. Pressure Switch/Blower Temperature Fault:
 - a. **Pressure switch closed at start of call for heat**-the gas control waits 4 seconds then, proceeds to flash 2 times with 3 second pause. The control waits 2 minutes and then turns on blower for 30 seconds. The blower turns off after 30 seconds and the control waits for pressure switch to open. Any time the pressure switch opens, the blower turns on (or stays on) and the control proceeds to wait for pressure switch to close.
 - b. **Pressure switch or blower temperature switch failed to close**-the gas control runs the blower for 30 seconds waiting for the pressure switch and/or blower temperature switch to close. If either switch does not close in 30 seconds, the blower turns off and the control flashes 3 times with 3 second pause. The gas control waits 2 minutes before turning on the blower for another 30 seconds to see the circuit close. This cycle repeats as long as there is a call for heat or until the circuit closes.
 - c. **Pressure switch or blower temperature switch opens during burner operation**-the gas control turns off the pilot and main valve, runs blower for 15 seconds (inter-purge) waiting for pressure switch and/or blower temperature switch to close. If either switch fails to close, the control proceeds as described in 3b above, if the circuit closes again by the end of the inter-purge, the recycle counter is incremented, if the recycle count has not reached its limit (4), another trial for ignition begins. If the recycle count has been reached, the gas control turns off the blower and flashes 6 times then, 2 times with 3 second pause. The gas control waits 5 minutes before repeating ignition sequence.
 4. Trail for Ignition Fault:
 - a. **Pressure switch opens during trial**-the gas control turns off igniter and pilot valve. The gas control proceeds as described in 3b above. If the pressure switch closes within 30 seconds the gas control will continue with trial for ignition starting at blower pre-purge.
 - b. **Flame not sensed**-the gas control energizes the spark igniter attempting to light the pilot and prove flame. If flame is not sensed within 90 seconds, the igniter turns off, the pilot valve is closed and the gas control runs the blower through post purge and flashes 6 times then, once with 3 second pause. The control waits 5 minutes before repeating the ignition sequence.

Abnormal Operation (cont.)

5. Flame sensing fault:
 - a. **Flame lost during run**-the gas control turns off pilot and main valves, runs blower for 15 seconds (inter-purge). The gas control increments the recycle count, if the recycle count has not reached its limit (4), another trial for ignition begins. If the recycle count has been reached, the gas control turns off the blower and flashes 6 times then, 3 times with 3 second pause. The gas control waits 5 minutes before repeating the ignition sequence.
 - b. **Flame sensed out of sequence**-the gas control only looks for pilot flame when the blower is running. If flame is present when the pilot valve is not open, the gas control proceeds to wait for flame loss and flashes 5 times with 3 second pause. This continues until flame is lost. Once the flame signal is lost, the control flashes 6 times then, 4 times with 3 second pause. The control waits 5 minutes before repeating the ignition sequence.

PV Series

Troubleshooting

Observe green LED indicator on electronic gas control. Error flash codes are displayed with a three second pause before repeating. Check and repair the system as noted in the troubleshooting table below.

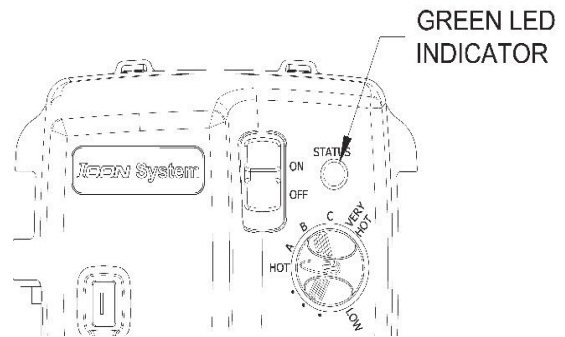

<u>LED Status</u>	<u>Control Status</u>	<u>Probable Cause</u>	<u>Service Procedure</u>
None, control LED not on or flashing	No electrical power	Control power switch in "OFF" position. Supply voltage interrupted.	Turn power on
Short flash, once every four seconds	Stand-by mode, Waiting for call for heat (no fault).	Temperature demand is satisfied	Normal operation. Adjust thermostat to temp level.
"Heartbeat" alternates bright/dim	Thermostat calling for heat (no fault).	Tank temperature below set point of thermostat.	Normal operation. Adjust thermostat to temp level.
Short flash once per second	Weak pilot signal on last call for heat.	1. Unstable pilot. 2. Pilot tube block or restricted. 3. Oxidation build up on pilot electrode. 4. Wire damage to pilot assembly or bad connection at gas valve.	Page 19
Two flash, three second pause	Pressure switch not working-closed position.	1. Pressure switch tubing kinked or blocked. 2. Blocked pressure tap on switch or blower. 3. Faulty pressure switch.	Page 20
Three flash, three second pause	Pressure switch or blower temp. switch not working -open position.	1. Vent blockage or improper vent configuration. 2. Pressure switch tubing kinked or blocked. 3. Faulty pressure switch. 4. Blower not spinning up to speed. 5. Blower temp or exhaust temp too high. 6. Faulty blower temperature switch.	1. Check vent or vent tables. 2 & 3 Page 20 4. Page 22 5 & 6 Page 24
Four flash, three second pause	Excessive tank temperature. System must be reset.	1. Temperature sensor out of calibration. 2. Faulty gas control. 3. Plumbing leak.	1. Page 25 2. Replace gas control, page 31
Five flash, three second pause	Undesired-false pilot flame present.	1. Pilot valve stuck in open position.	Replace gas control, page 31

PV Series

Troubleshooting

<u>LED Status</u>	<u>Control Status</u>	<u>Probable Cause</u>	<u>Service Procedure</u>
Six-one flash, three second pause	Failed to light pilot. System auto resets.	<ol style="list-style-type: none"> 1. Unstable pilot. 2. Pilot tube blocked or restricted. 3. Oxidation build up on pilot electrode. 4. Wire damage to pilot assembly or bad connection at gas valve. 	Page 19
Six-two flash, three second pause	Pressure switch or blower temp switch opened during burner operation. System auto resets.	<ol style="list-style-type: none"> 1. Vent blockage or improper vent configuration. 2. Pressure switch tubing kinked or blocked. 3. Faulty pressure switch. 4. Vent termination being affected by wind. 5. Blower not spinning up to speed. 6. Blower temp or exhaust temp too high. 7. Faulty blower temperature switch. 	<ol style="list-style-type: none"> 1. Check vent or vent tables. 2 & 3 Page 20 4. Refer to venting section of installation manual 5. Page 22 6 & 7 Page 24
Six-three flash, three second pause	Pilot flame extinguished. System auto resets.	<ol style="list-style-type: none"> 1. Unstable pilot. 2. Pilot tube blocked or restricted. 3. Oxidation build up on pilot electrode. 4. Wire damage to pilot assembly or bad connection at gas valve. 5. Insufficient combustion air. 6. Gas pressure is out of specification. 	<ol style="list-style-type: none"> 1-4. Page 19 5. Refer to installation manual 6. Page 26
Six-four flash, three second pause	Undesired-false pilot flame sensed. System auto resets.	Pilot valve stuck in open position.	Replace gas control, page 31
Seven flash, three second pause	Flammable vapor sensor fault detected.	Flammable vapor sensor or simulative resistance device out of specification.	Page 33
Eight-one flash, three second pause	Flammable vapor sensor out of specification.	Flammable vapor sensor or simulated resistive device out of specification.	Page 33
Eight-two flash, three second pause	Temperature Sensor fault.	<ol style="list-style-type: none"> 1. Damage to temperature sensor wire. 2. Temperature sensor resistance out of range. 	Page 29
Eight-three flash, three second pause	Gas valve electronics fault detected.	<ol style="list-style-type: none"> 1. Control needs to be reset. 2. Control is wet or physically damaged. 	<ol style="list-style-type: none"> 1. Interrupt power supply 2. Replace gas control, page 31
Eight-four flash, three second pause	Gas valve fault detected.	<ol style="list-style-type: none"> 1. Control needs to be reset. 2. Control is wet or physically damaged. 	<ol style="list-style-type: none"> 1. Interrupt power supply 2. Replace gas control, page 31

PV Series

PV SERVICE PROCEDURE I
Burner Operation Inspection,
Cleaning and Replacement

Burner Inspection

At periodic intervals (every 6 months) a visual inspection should be made of the pilot and main burner for proper operation and to assure no debris is accumulating.

Pilot flame should be stable, some causes for an unstable pilot flame are:

- a) Water heater vent is less than the allowable vent length.
- b) Gas pressure is out of specification.
- c) Pilot flame not fully engulfing spark/flame sensor.

Main burner should light smoothly from pilot and burn with a blue flame with a minimum of yellow tips.

Main burner must be free from any debris accumulation that may affect burner operation (see burner cleaning procedure on page 18).

PV Series

PV SERVICE PROCEDURE I Burner Operation Inspection, Cleaning and Replacement

Burner Cleaning

- Step 1. Position gas control power switch to the "OFF" position and unplug heater from wall outlet.
- Step 2. Turn off gas supply to water heater.
- Step 3. Remove outer jacket door and inner door per service procedure XIII on page 39.
- Step 4. Disconnect pilot tube (7/16" wrench) and feedline (3/4" wrench) from gas control.
- Step 5. Disconnect igniter/flame sensor wire from gas control.
- Step 6. Remove burner assembly from combustion chamber.
- Step 7. Thoroughly inspect burner surface area and burner port area and remove any loose debris.
- Step 8. Unscrew burner from main burner orifice.

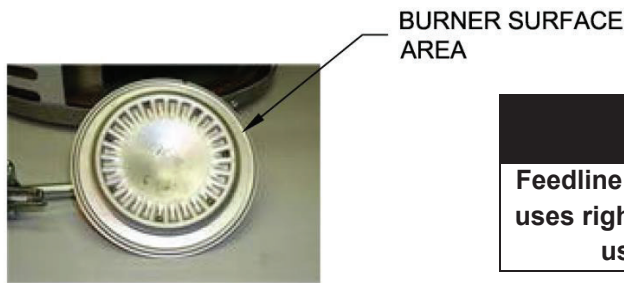
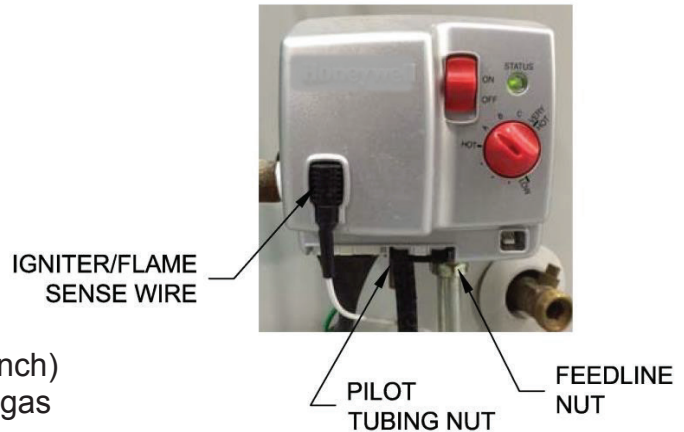

NOTICE
Feedline nut for natural gas control uses right hand threads, LP control uses left hand thread.

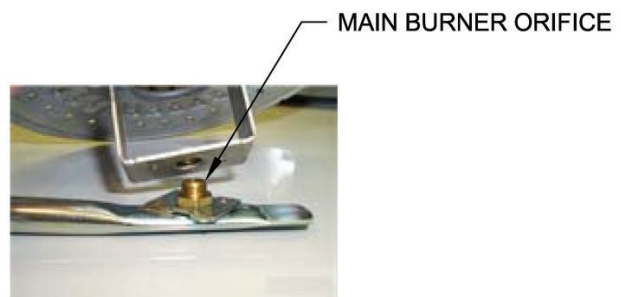
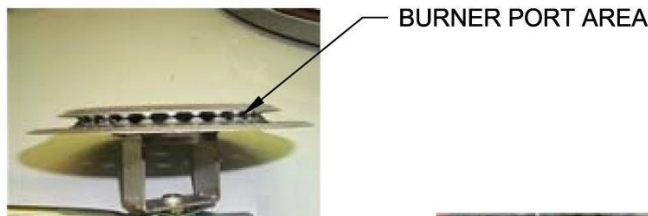

- Step 9. Remove main burner orifice from feedline (1/2" wrench on steel burners) inspect orifice, clean or replace if necessary.
- Step 10. Reassemble burner and reinstall into water heater. Restore gas supply and check for gas leaks.
- Step 11. To resume operation, follow the instruction located on the lighting instruction label or the lighting instruction located in the installation and operation manual.

PV Series

PV SERVICE PROCEDURE II Pilot Inspection, Testing and Replacement

Pilot Inspection, Testing and Replacement

- Step 1. Position gas control power switch to the "OFF" position and unplug heater from wall outlet.
- Step 2. Turn off gas supply to water heater.
- Step 3. Remove outer jacket door and inner door per service procedure XIII on page 39.
- Step 4. Disconnect pilot tubing nut (7/16" wrench) and feedline nut (3/4" wrench) from gas control.
- Step 5. Disconnect igniter/flame sense wire from gas control.
- Step 6. Remove burner assembly from combustion chamber.
- Step 7. Remove pilot assembly from feedline (1/4" nut driver).
- Step 8. Visually inspect igniter/flame sense wire for damage. Replace pilot if damage is found.
- Step 9. With a multi-meter set to ohms setting, check continuity through igniter/flame sense wire. Replace pilot if no continuity.
- Step 10. Visually inspect igniter/flame sense electrode for deterioration. Replace pilot as necessary. Electrode should not be in contact with pilot hood, if so, carefully adjust electrode to a gap of distance of 3/32" (.09) from pilot hood.
- Step 11. Visually inspect igniter/flame sense electrode for oxidation build up. Carefully clean any oxidation using very fine emery cloth.
- Step 12. Visually inspect pilot tubing for kinks or cracks. If damage is found, replace pilot.
- Step 13. Inspect pilot tubing and pilot orifice for blockage:
 - a. Remove ferrule nut from bottom of pilot assembly (7/16" wrench).
 - b. Remove pilot tube and pilot orifice.
 - c. Inspect pilot tubing and pilot orifice for blockage. Clean or replace as necessary.
- Step 14. Reassemble pilot and install on feedline. Reinstall burner assembly to water heater. Restore gas supply and check for gas leaks.

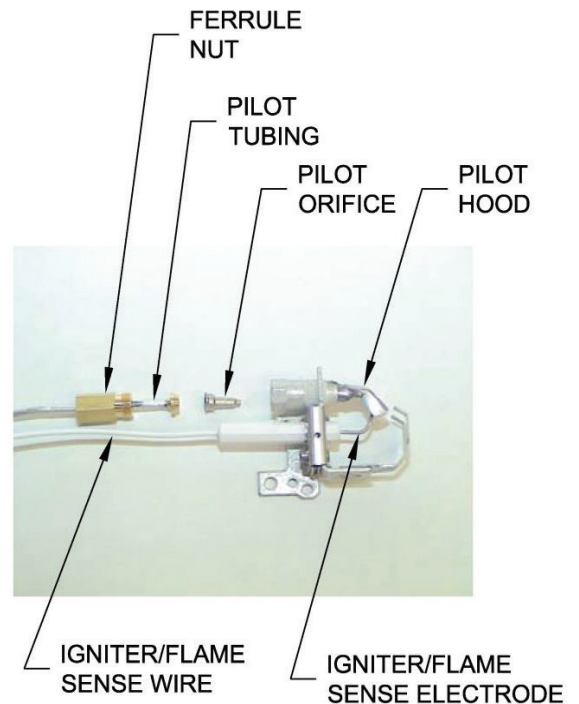
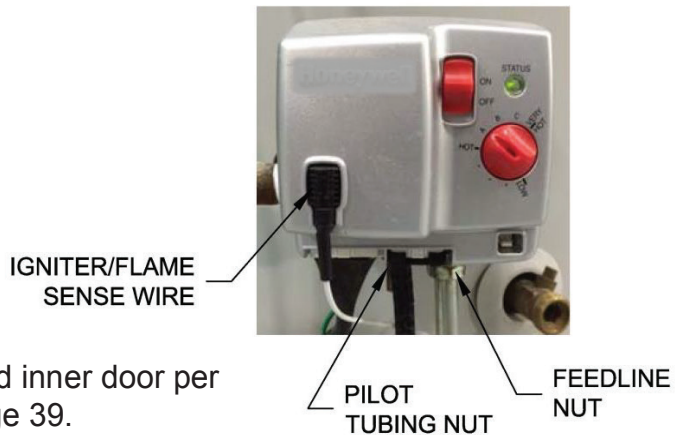

PV Series

PV SERVICE PROCEDURE III Pressure Switch Testing and Replacement

Step 15. To resume operation, follow the instructions located on the lighting instruction label or the lighting instructions located in the installation and operation manual.

Pressure Switch Testing

- Step 1. Position power switch on gas control to the "OFF" position.
- Step 2. Remove the three screws (Phillips screw driver) from control access cover on blower assembly and remove cover (see photo 1).
- Step 3. Remove pressure switch from blower housing by removing the two T10 screws (see photo 2a). If it does not have 2 screws, carefully remove it from the housing (see photo 2b).

⚠ WARNING
115 volt potential exposure. Use caution to avoid personal injury.

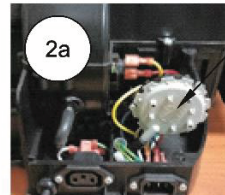

PRESSURE SWITCH



PRESSURE SWITCH WIRE LEADS

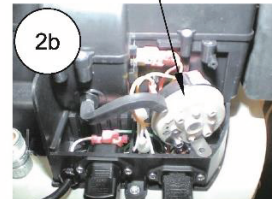

PRESSURE SWITCH

Slide pressure switch in direction of arrow while tilting slightly away from blower housing.

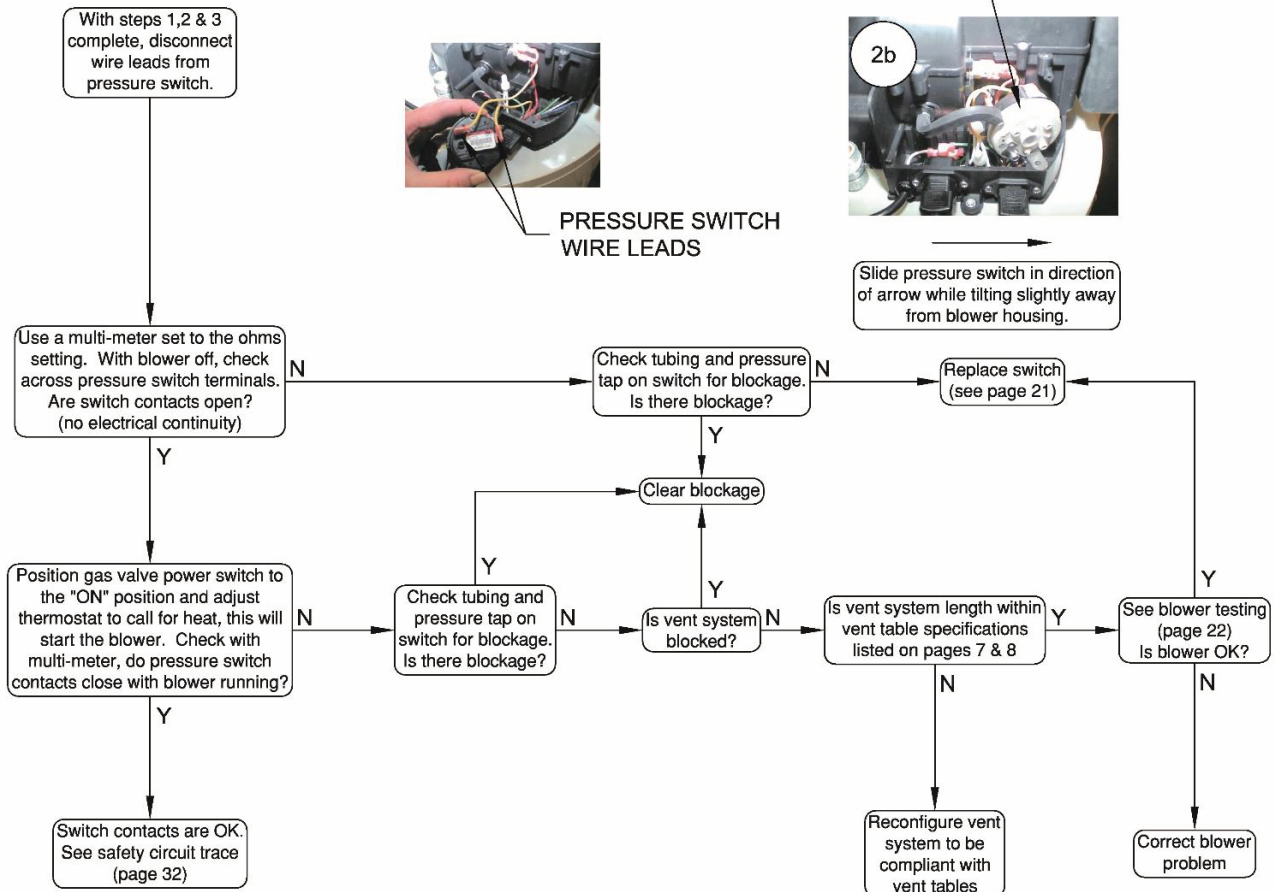

PV Series

PV SERVICE PROCEDURE III Pressure Switch Testing and Replacement

Pressure Switch Replacement

- Step 1. Position gas control power switch to "OFF" position.
- Step 2. Remove the three screws (Phillip's screw driver) from control access cover on blower assembly and remove cover (see photo 3).
- Step 3. Remove pressure switch from blower housing by removing the two T10 screws (see photo 4a). If it does not have 2 screws, carefully remove it from the housing (see photo 4b).
- Step 4. Disconnect tubing from pressure switch (see photo 5).
- Step 5. Disconnect yellow wires from pressure switch (see photo 6).
- Step 6. Reconnect yellow wires from step 5 to new pressure switch.
- Step 7. Reconnect tubing to new pressure switch.
- Step 8. Carefully position pressure switch into blower housing (see photo 4b).
- Step 9. Position gas control power switch to "ON" position and verify proper heater operation.
- Step 10. Replace control access cover from step 2.

⚠ WARNING

115 volt potential exposure. Use caution to avoid personal injury.

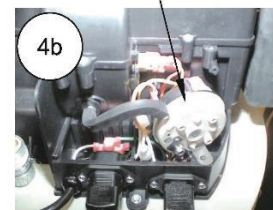
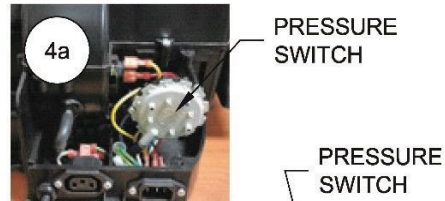
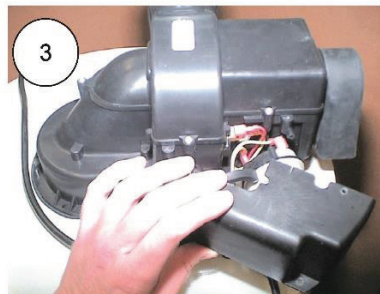

Slide pressure switch in direction of arrow while tilting slightly away from blower housing.



PV Series

PV SERVICE PROCEDURE IV Blower Testing and Replacement

Blower Testing

- Step 1. Position gas control power switch to "ON" position and adjust control to call for heat.
- Step 2. Remove the three screws (Phillip's screw driver) from control access cover on blower assembly and remove cover (see photo 7).

⚠ WARNING

115 volt potential exposure. Use caution to avoid personal injury.

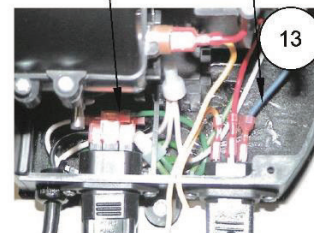
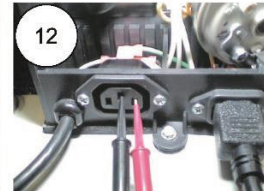
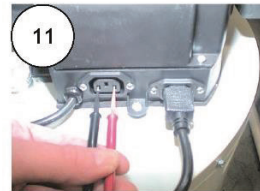
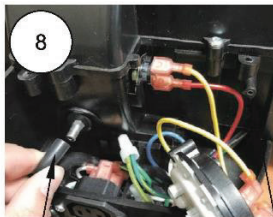
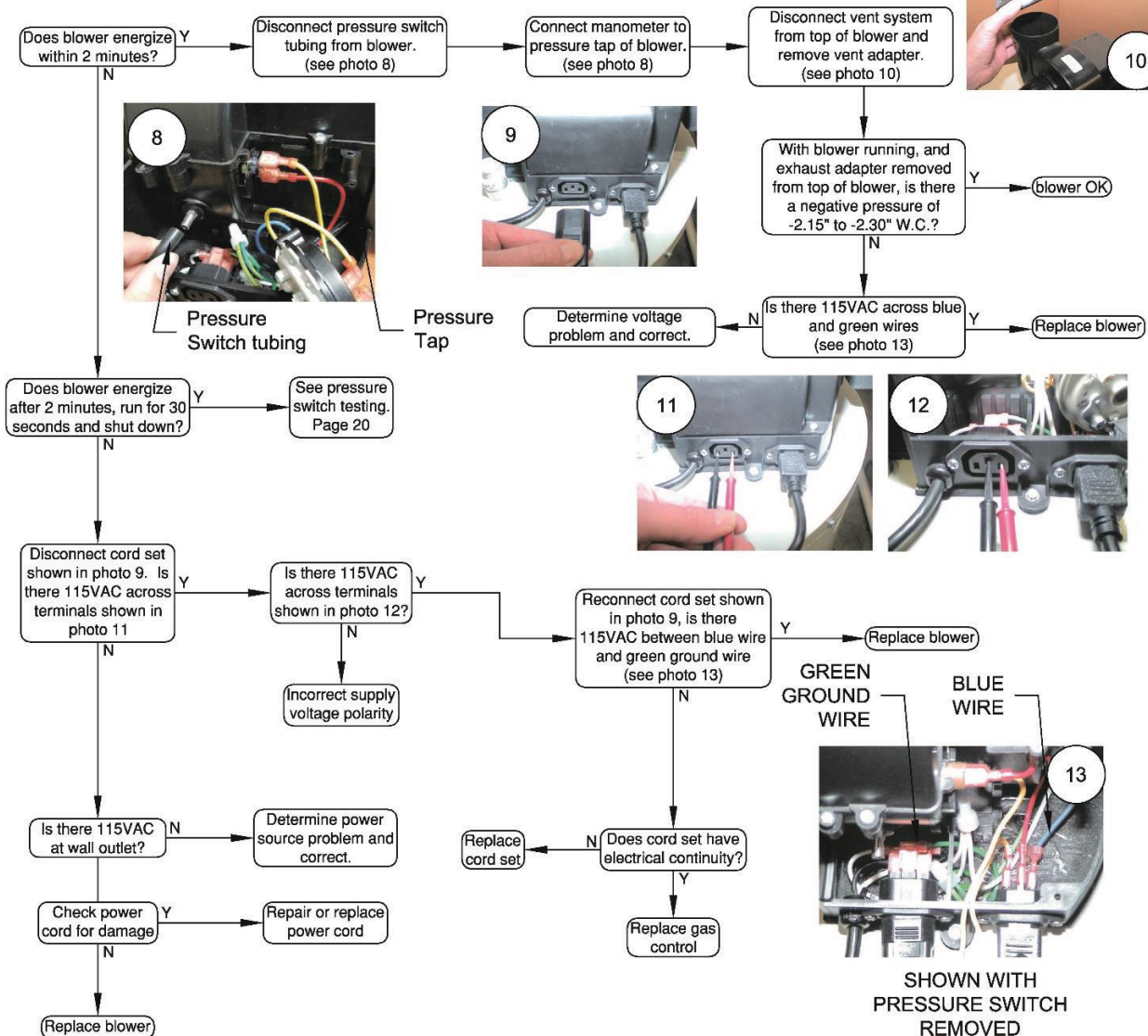

SHOWN WITH PRESSURE SWITCH REMOVED

Blower Removal

- Step 1. Position gas control power switch to “OFF” position and adjust control to call for heat.
- Step 2. Unplug blower power cord from wall outlet.
- Step 3. Disconnect vent system from exhaust adapter on top of blower.
- Step 4. Remove exhaust adapter from blower (blade screw driver) and retain for use on new blower.
- Step 5. Unplug cord sets from blower.
- Step 6. Remove the three blower mounting screws (1/4” nut driver).
- Step 7. Remove blower with gasket from water heater.

Remove exhaust adapter and retain for use on new blower

Blower Mounting Screws



Blower cord sets

Locating Pins on blower flange

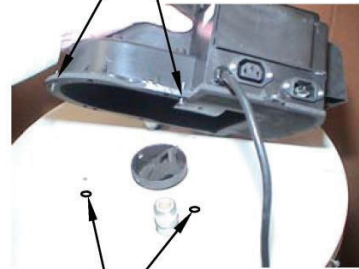

Pin location holes in jacket head

Blower Installation

- Step 8. Clean any debris from jacket head of water heater.
- Step 9. Set new blower with gasket in place using locating pins on blower flange to line up with location holes in jacket head. Be sure not to damage gasket.
- Step 10. Secure blower in place using mounting screws from step 6.
- Step 11. Re-install exhaust adapter from step 4.
- Step 12. Reconnect vent system to exhaust adapter.
- Step 13. Reconnect cord sets from step 5.
- Step 14. Plug blower power cord into wall outlet.
- Step 15. Position gas control power switch to the “ON” position.
- Step 16. Verify proper blower operation.

PV Series

PV SERVICE PROCEDURE V Blower Temperature Switch Testing and Replacement

Blower Temperature Switch Testing

Position power switch on gas control to the "OFF" position.

- Step 1. Remove the three screws (Phillip's screw driver) from control access cover on blower and remove cover (see photo 14).
- Step 2. Locate blower temperature switch (see photo 15).

⚠ WARNING

115 volt potential exposure. Use caution to avoid personal injury.



BLOWER TEMPERATURE SWITCH LOCATION

AIR MIXING INLET

Switch Setting
Opens on rise @ approximately 165°F
Auto resets on fall @ approximately 130°F

Cool switch to below 130°F

Disconnect wire leads to switch. Using a multi-meter set to the ohms setting, is there continuity between the switch terminals?

Replace switch (see page 25)

Reconnect wire leads and observe heater operation. Do exhaust gas temperatures rise to or above 170°F with vent connected?

Do switch contacts open?

Exhaust temperature is too hot.

Do switch contacts open?

Replace switch (see page 25)

Switch OK

Common causes for high exhaust temperatures

1. Vent length is below minimum allowable.
2. Vent diameter not to specification.
3. Restricted dilution air inlet.
4. Missing or deteriorated flue baffle.
5. Gas pressure is out of specification.

PV Series

PV SERVICE PROCEDURE V Blower Temperature Switch Testing & Replacement

Blower Temperature Switch Replacement

⚠ WARNING

115 volt potential exposure. Use
caution to avoid personal injury.

- Step 1. Position gas control power switch to the "OFF" position and unplug heater from wall outlet.
- Step 2. Remove the three screws (Phillip's screw driver) from the control access cover on blower and remove cover (see photo 16).
- Step 3. Locate blower temperature switch (see photo 17).
- Step 4. Disconnect red and yellow wire leads from switch.
- Step 5. With an appropriate tool such as side cutters, snip the retaining lug from the blower housing to allow removal of temperature switch (see photo 18).
- Step 6. Remove switch from blower housing.
- Step 7. Install new switch. Be sure switch is properly seated in mounting area.
- Step 8. Reconnect red and yellow wires to new switch. Wires are interchangeable with either terminal.
- Step 9. Position gas control power switch to the "ON" position and verify proper heater operation.
- Step 10. Replace control access cover from step 2.

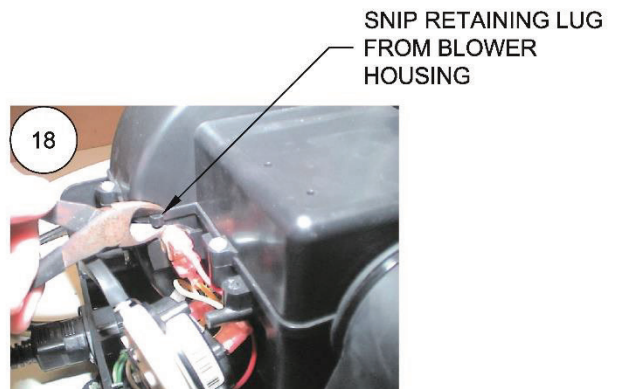
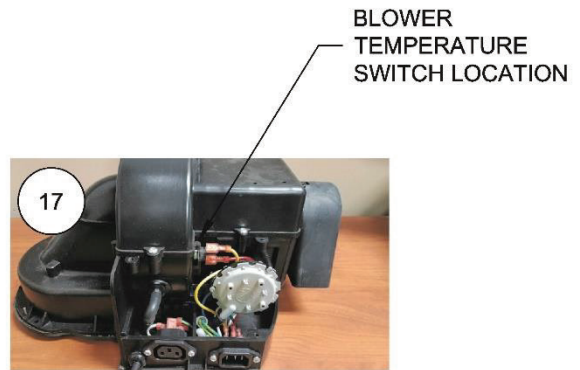

Line Pressure

The gas control is designed for a maximum line pressure of 14.0" W.C. and a minimum line pressure of 1.0" W.C. over the water heater's rated manifold pressure (check rating plate). Line pressure must be checked with the main burner on and off to assure proper readings.

Manifold Pressure Testing

(this procedure presumes a maximum line pressure of 14.0" W.C.)

- Step 1. Set the Gas Control to the "OFF" position.
- Step 2. Remove pressure tap plug and install 1/8" NPT pipe, coupling & pressure tap.
- Step 3. Connect manometer to pressure tap.
- Step 4. Follow instructions located on the lighting instructions label and proceed to light the main burner and observe manometer reading.
- Step 5. Proper operating range for Natural Gas is 4.0" \pm 0.5" W.C. Proper operating range for Propane gas is 10.0" \pm 0.5" W.C.
- Step 6. If pressure is within the range specified in the previous step, set Gas Control knob to the "OFF" position, remove manometer and pressure tap, and replace pressure tap plug. Check for gas leaks prior to placing water heater back into operation by following the instructions located on the lighting label, or the lighting instructions located in the installation and operation manual.
- Step 7. If gas pressure is outside the specification noted above, refer to "Resideo Gas Control Testing, Disassembly and Replacement" to replace gas control or valve body.

GAS CONTROL
SHOWN IN THE
"OFF" POSITION



3/16"
ALLEN
WRENCH

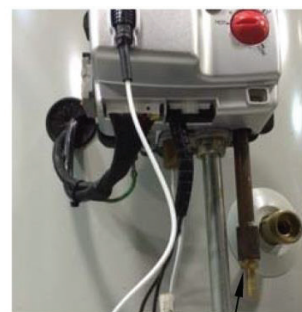

PRESSURE TAP
SHOWN INSTALLED

ECO (Energy Cut Out)

The Resideo gas control is designed with an ECO device that will reset.

To reset the gas control after an error code (4), turn the gas control knob to the “LOW” position and wait a minimum of (5) minutes before relighting following the instructions located on the lighting instruction label or the lighting instructions located in the installation and operation manual.

Gas Control Disassembly/Reassembly

- Step 1. Set the gas control to the “OFF” position.
- Step 2. Turn off gas supply to water heater.
- Step 3. Disconnect gas supply line from gas control.
- Step 4. Disconnect igniter/flame sensor wire.
- Step 5. Remove outer jacket door.

GAS CONTROL SHOWN IN THE “OFF” POSITION



- Step 6. Remove gas control cover screw.

GAS CONTROL COVER SCREW



- Step 7. Depress both tabs on the top of the gas control cover and pull to remove.

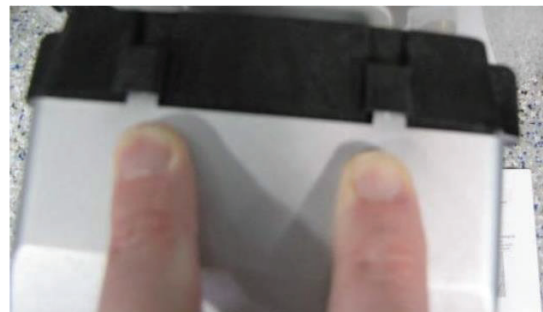

Gas Control Disassembly/Reassembly (cont.)

Step 8. Disconnect temperature sensor from control board.

Step 9. To reassemble gas control, follow the previous steps in reverse order. Once gas control is reassembled, burner assembly is reinstalled, and the gas supply line is reconnected, resume water supply to water heater. Be sure tank is full of water before relighting.

Step 10. To resume operation, follow the instructions located on the lighting instruction label or the lighting instructions located in the installation and operation manual.

⚠ CAUTION

Use care not to bend or damage valve body pins when removing or installing gas control cover.

DISCONNECT
TEMPERATURE
SENSOR

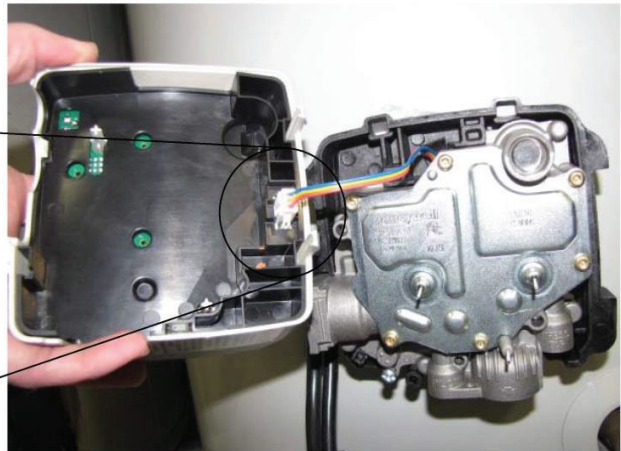
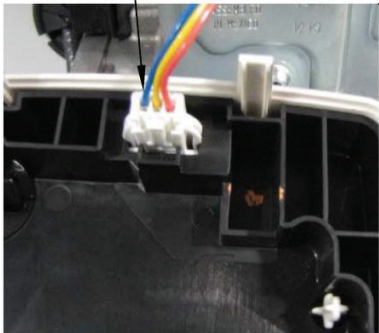

VALVE BODY PINS

Temperature Sensor Testing

Using a multi-meter set to the ohms setting, insert one meter probe (see caution) into center wire position of temperature sensor connector, insert the second probe (see caution) into either of the outside wire positions (see photo 19).

Alternate the probe on the outside position to the opposite outside wire position (see photo 20).

⚠ CAUTION

Do not use standard multi-meter probes for this test. Doing so will damage connector. Use special pin type electronic probes or small diameter wire pins inserted into connector.

If control has gone into lockout due to excessive tank temperature (four flash, three second pause) reset control by sliding gas control knob to "OFF" position and wait a minimum of (5) minutes. Then follow lighting instructions and return gas control knob to desired setpoint.

Observe Green LED indication. Does error code 4 (four flash, three second pause) continue?

Y

Confirm that the water temperature inside the tank has cooled. Draw approximately 4 gallons of water from the drain valve into a container and discard. Draw an additional gallon and immediately measure the temperature using an accurate thermometer.

If it is confirmed that the water temperature has cooled down below the setpoint level and you are still observing an error code 4 as above replace the gas control.

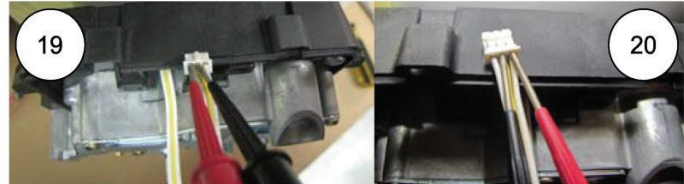

19

20

Resume normal operation

Determine Water Temperature Inside Tank

⚠ WARNING

Stored water may be HOT WHEN PERFORMING THE FOLLOWING STEPS IN THIS PROCEDURE. Take necessary precaution to prevent personal injury.

Note: It is important to understand once the resistance for the temperature sensor is determined from page 29, water flow through the heater should not occur. Prior to performing the steps below, turn off the cold water supply to the water heater. This will prevent cold water flow into the tank affecting the resistance value of temperature sensor.

- Step 1. Position gas control power switch to "OFF" position.
- Step 2. Draw approximately 4 gallons of water from the drain valve into a container and discard. Draw an additional gallon and immediately measure water temperature using an accurate thermometer (It may be necessary to open a hot water faucet to allow heater to drain).
- Step 3. Using the chart below, determine correct resistance value for the water temperature from step 2.

Example: If temperature of water is 84°F, then the resistance through the temperature sensor would be 8449 (see shaded area). NOTE: Temperature sensor resistance increases as the temperature falls.

Temperature Sensor Resistance at Various Temp.s

In Degrees F										
°F	0	1	2	3	4	5	6	7	8	9
40	26109	25400	24712	24045	23399	22771	22163	21573	21000	20445
50	19906	19383	18876	18383	17905	17440	16990	16553	16128	15715
60	15314	14925	14548	14180	13823	13477	13140	12812	12494	12185
70	11884	11592	11308	11032	10763	10502	10248	10,000	9760	9526
80	9299	9078	8862	8653	8449	8250	8057	7869	7685	7507
90	7333	7165	7000	6839	6683	6531	6383	6238	6098	5961
100	5827	5697	5570	5446	5326	5208	5094	4982	4873	4767
110	4663	4562	4464	4368	4274	4183	4094	4006	3922	3839
120	3758	3679	3602	3527	3453	3382	3312	3244	3177	3112
130	3048	2986	2925	2866	2808	2752	2697	2643	2590	2538
140	2488	2439	2391	2344	2298	2253	2209	2166	2124	2083
150	2043	2004	1966	1928	1891	1856	1820	1786	1753	1720
160	1688	1656	1625	1595	1566	1537	1509	1481	1454	1427
170	1402	1376	1351	1327	1303	1280	1257	1235	1213	1191
180	1170	1150	1129	1110	1090	1071	1953	1035	1017	999
190	982	965	949	933	917	901	886	871	857	842
200	828	814	801	788	775	762	749	737	725	713

PV Series

PV SERVICE PROCEDURE VII Flammable Vapor/Simulative Resistance Device Testing

Gas Control Removal From Water Heater

- Step 1. Position the gas control power switch to the "OFF" position and unplug heater from wall outlet.
- Step 2. Drain the heater to a point below the gas control level.
- Step 3. Turn off the gas supply to the water heater and disconnect gas piping from the gas control.
- Step 4. Disconnect wire harnesses from the gas control.
- Step 5. Remove the outer jacket burner access door.
- Step 6. Right side inner door removal.
 - a. Remove (2) hex drive screws from RIGHT side inner door.
 - b. Remove (2) hex drive screws from FLANGE SECTION of inner door.
 - c. Remove right side inner door and set aside. Be careful not to damage gasket material in inner door.
- Step 7. Removal of Gas Control
 - a. Disconnect main burner feedline and pilot tube.
 - b. Remove Gas Control from water heater by rotating counter clockwise. DO NOT use a wrench on the Gas Control body, damage to the Gas Control may occur. If necessary, use a length of 1/2" NPT pipe threaded into the gas inlet of Gas Control.

GAS CONTROL
SHOWN IN THE
"OFF" POSITION

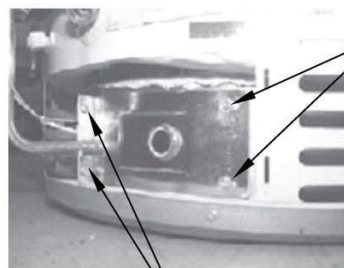

1/4" HEX DRIVE SCREWS
RIGHT AND LEFT SIDE
INNER DOOR.

1/4" HEX DRIVE SCREWS
AT FLANGE AREA OF
INNER DOOR

- Step 8. Install new Gas Control into water heater.
 - a. Install new Gas Control into water heater by rotating Clockwise. DO NOT use a wrench on the Gas Control body, damage to the Gas Control may occur. If necessary, use a length of 1/2" NPT pipe threaded into the gas inlet of the Gas Control.
 - b. Reattach main burner feedline , pilot tube and pilot wire.

Reinstallation of inner door assembly.

- c. Prior to reinstallation of inner door, fully inspect for the following:
- Tears
 - Missing material
 - Cracks
 - Dirt or debris
 - Other imperfections that will inhibit proper seal
 - Gasket adhesion to inner door
 - Material left on combustion chamber (around opening)

If the gasket is not affected by any of the above, gasket replacement may not be required. If replacement is required, replace using new gasket kit following the instructions provided with

- d. Clean any gasket residue or other debris from combustion chamber surface before installing the inner door/gasket assembly.
- e. Position the spark igniter wire and pilot tube against left side inner door flange gasket. **DO NOT ROUTE THROUGH RADIUS CHANNEL WITH FEEDLINE.** Be sure that the spark igniter wire and pilot tube are not in position to interfere with outer jacket burner access door when reinstalled.
- f. Firmly place right side inner door flange against the left side inner door flange and secure with (2) hex drive screws from step 6b. **DO NOT OVER TIGHTEN SCREWS.**
- g. Align right side inner door to combustion chamber and verify the fastener holes of the combustion chamber are aligned with the right side inner door slotted openings. Verify seal integrity around combustion chamber opening. Secure right side inner door using (2) hex drive screws from step 6a. **DO NOT OVER TIGHTEN SCREWS.** Verify both left and right sides of the inner door are properly positioned and sealed against the combustion chamber.

⚠ CAUTION

A seal breach may result in a fire or explosion causing property damage, personal injury or death.

Step 9. Replace outer jacket burner access door.

Step 10. Reconnect gas supply to Gas Control.

Step 11. Resume water supply to water heater. Be sure tank is full of water before resuming operation.

Step 12. To resume operation follow the instructions located on the lighting instruction label or the lighting instructions located in the installation and operation manual.

PV Series

PV SERVICE PROCEDURE VII Flammable Vapor/Simulative Resistance Device Testing

Flammable Vapor/Simulative Resistance Device Testing

- Step 1. Position power switch on gas control to the "OFF" position.
- Step 2. Disconnect flammable vapor sensor from gas control.
- Step 3. Using a multi-meter set to the ohms setting, check resistance of flammable vapor sensor. Resistance must be between 3,000 ohms and 48,000 ohms. If outside of this range replace Flammable Vapor Sensor or Simulated Resistive Device.

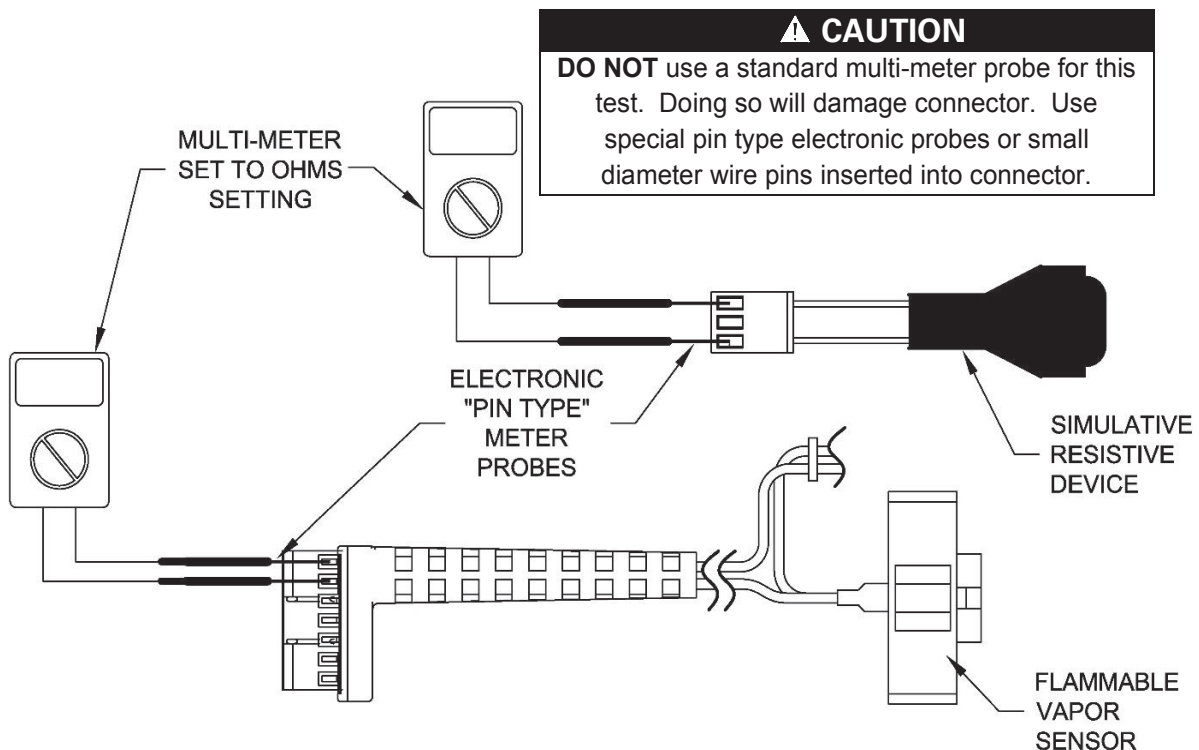
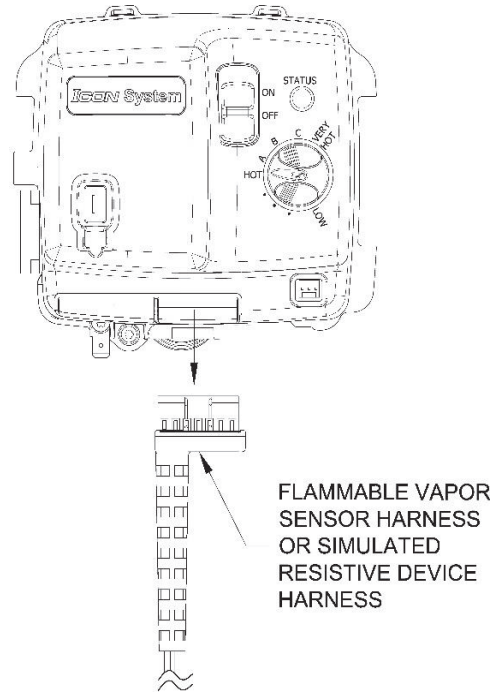

PV Series

PV SERVICE PROCEDURE VIII Safety Circuit Voltage Trace

Safety Circuit Voltage Trace

NOTE: This procedure assumes a cool tank.

⚠ WARNING
115 volt potential exposure. Use caution to avoid personal injury.



Remove three screws (Phillips Screw driver) from control access cover on blower and remove cover (see photo 19).

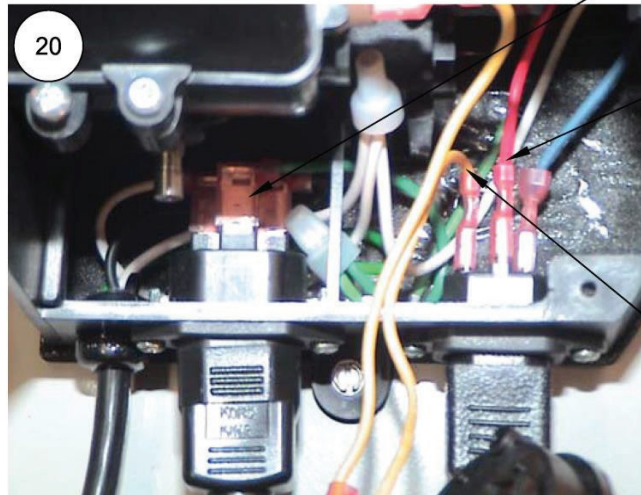
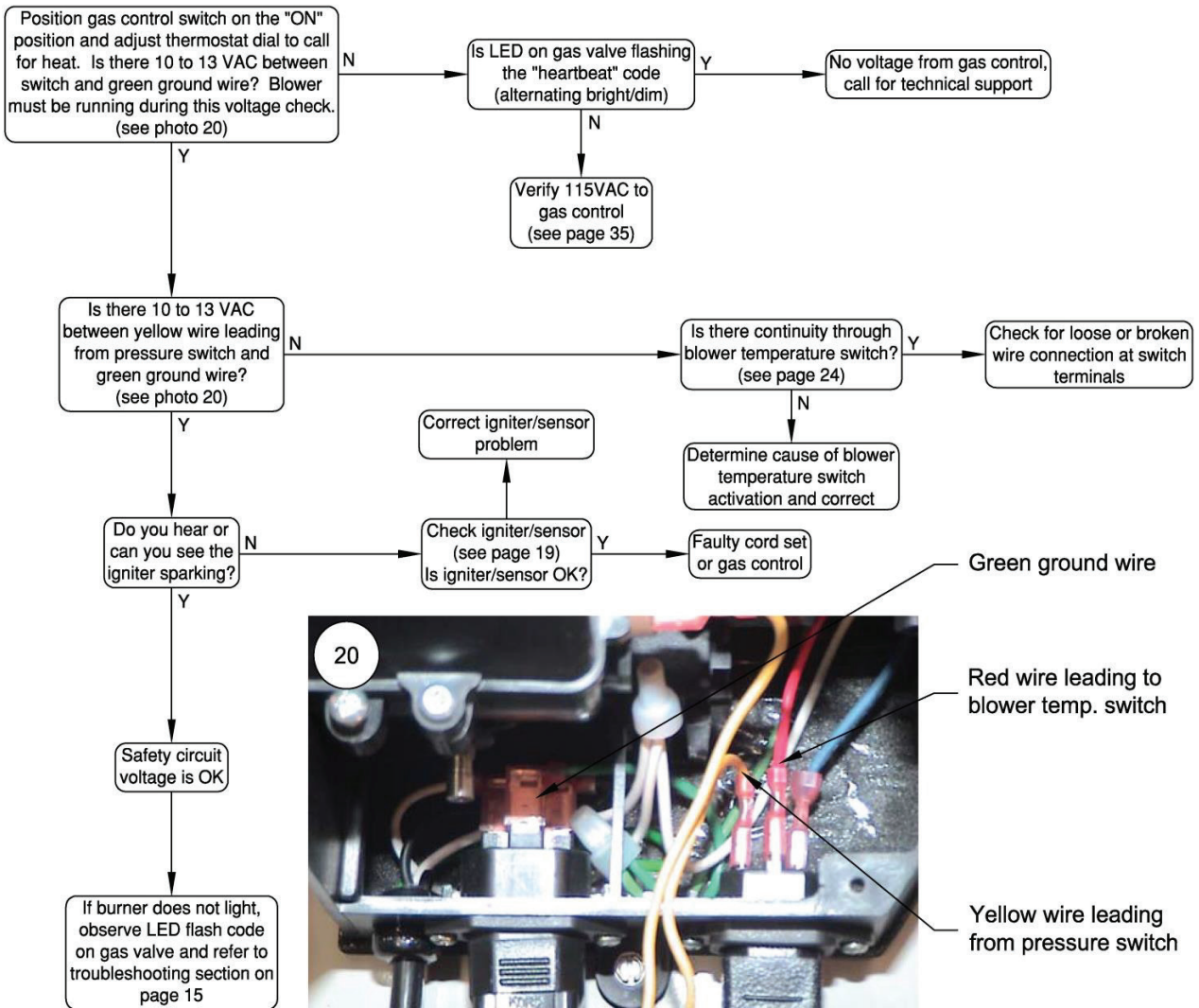

PV Series

PV SERVICE PROCEDURE IX 115 VAC Trace

115 VAC Circuit Trace

- Step 1. Verify 115 VAC and proper polarity at wall outlet.
- Step 2. With unit plugged in and control power switch in the "ON" position verify LED status.

⚠ WARNING
115 volt potential exposure. Use caution to avoid personal injury.

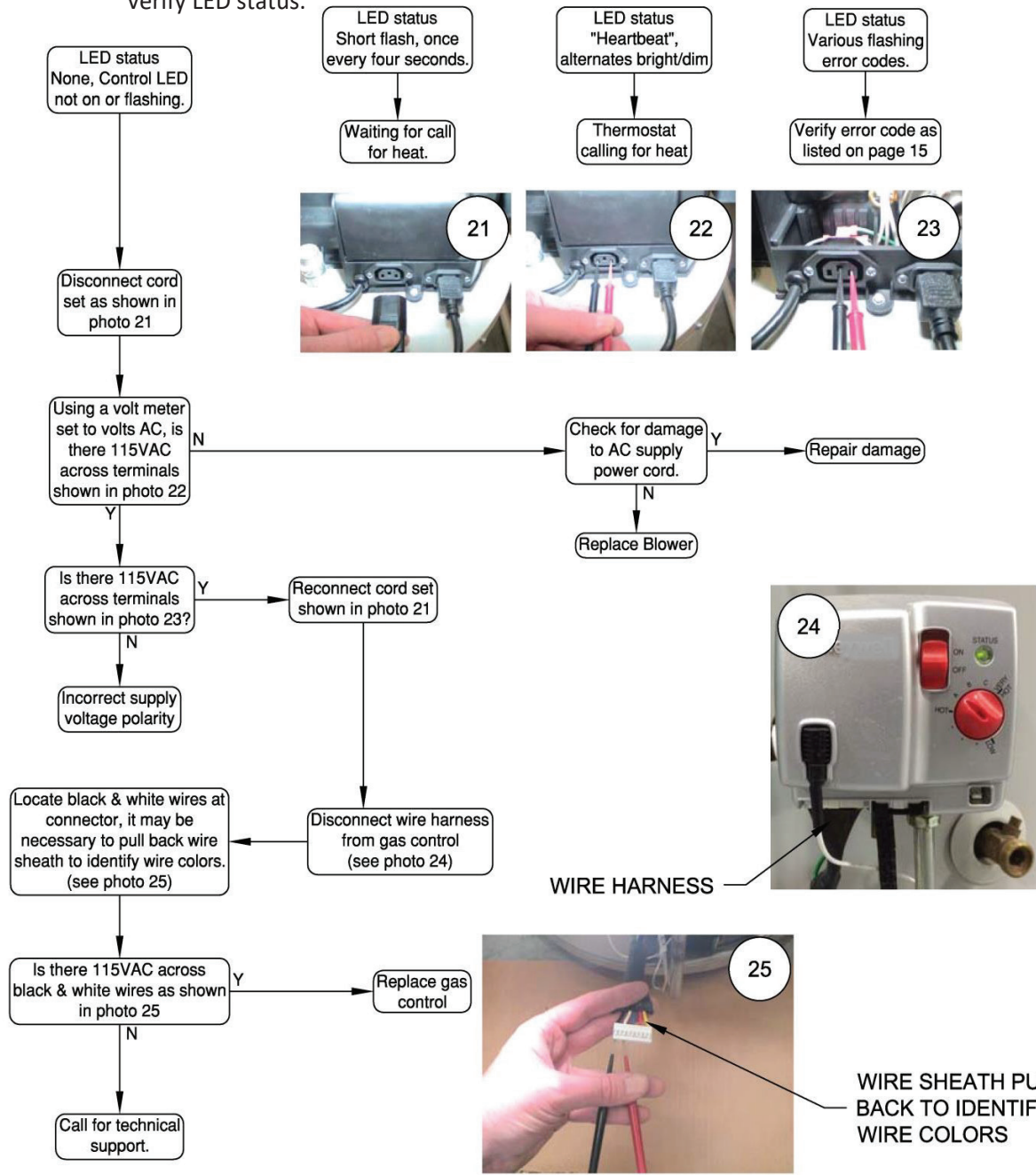

Check for 115VAC between black & white wires.
-NOTE-
Electronic meter probes required. Use care not to damage connector during this check.

Diptube Inspection & Replacement

⚠ WARNING

Water Heater components and stored water may be HOT when performing the following steps in this procedure. Take necessary precaution to prevent personal injury.

- Step 1. Position on/off switch of gas control valve to “OFF” position and unplug water heater from wall outlet.
- Step 2. Turn off cold water supply to water heater. Connect hose to drain valve of water heater and route to an open drain. Open a nearby hot water faucet to vent heater for draining. Open drain valve of water heater and allow heater to drain to a point below the inlet connection nipple.
- Step 3. Disconnect inlet nipple from plumbing system.
- Step 4. With an appropriate tool such as a pipe wrench, remove inlet nipple/dip tube from the water heater. Use caution not to damage pipe threads.
- Step 5. Visually inspect inlet nipple/dip tube. Inlet nipple/dip tube should be free of cracks and any blockage. Hydrojet slots should be open and free of any blockage. Any damage such as cracks, restriction due to deformation or unintentional holes are not field repairable and the inlet nipple/dip tube must be replaced.
- Step 6. Upon completion of inspection or subsequent replacement, reinstall inlet nipple/dip tube into water heater. Ensure pipe dope is used on the nipple’s threads. Connect nipple to plumbing system, resume water supply and refill with water.
- Step 7. To resume operation follow the instructions located on the lighting instruction label or the lighting instructions located in the installation and operation manual.

Anode Inspection & Replacement

⚠ WARNING

Water Heater components and stored water may be HOT when performing the following steps in this procedure. Take necessary precaution to prevent personal injury.

- Step 1. Position on/off switch of gas control valve to the “OFF” position and unplug water heater from wall outlet.
- Step 2. Turn off cold water supply to water heater. Connect hose to drain valve of water heater and route to an open drain. Open a nearby hot water faucet to vent water heater for draining. Open drain valve of water heater and allow water heater to drain to a point below the outlet connection nipple.
- Step 3. Disconnect outlet nipple from plumbing system.
- Step 4. With an appropriate tool such as a pipe wrench, remove outlet nipple/anode from the water heater. Use caution not to damage pipe threads.
- Step 5. Visually inspect outlet nipple/anode. Outlet nipple/anode should show signs of depletion, this is normal. If depletion is $\frac{1}{2}$ of the original anode diameter (approximately $\frac{3}{4}$ ” diameter), replacement is recommended. If any of the steel core of the anode is exposed, replacement is recommended.
- Step 6. Upon completion of inspection or subsequent replacement, reinstall outlet nipple/anode into water heater. Ensure pipe dope is used on the nipple’s threads. Connect nipple to plumbing system, resume water supply and refill with water.
- Step 7. To resume operation, follow the instructions located on the lighting instruction label or the lighting instructions located in the installation and operation manual.

Flue Baffle Inspection and Replacement

- Step 1. Position gas control power switch to the "OFF" position and unplug blower from wall outlet.
- Step 2. Disconnect vent system from exhaust adapter on top of blower.
- Step 3. Unplug cord sets from blower (see photo 26).
- Step 4. Remove the three blower mounting screws (1/4" nut driver) (see photo 26).
- Step 5. Remove blower with gasket from water heater.
- Step 6. Remove flue baffle or flue core from heater (see photos 27a and 27b).
- Step 7. Inspect baffle or core for deterioration, missing restrictors. Clean any scale or debris build up. Replace with new baffle or core as necessary.
- Step 8. Reinstall baffle or core into flue tube. Be sure hanger tabs are inserted into notch location at the top of the flue tube (see photos 28 & 29).
- Step 9. Check burner to insure no scale has accumulated during this operation. See burner cleaning procedure on page 18.
- Step 10. Reinstall blower on water heater. Connect vent system and cords set to blower. Plug water heater into wall outlet.
- Step 11. To resume operation follow the lighting instruction located on the lighting instruction label or the lighting instruction located in the installation operation manual.

DISCONNECT VENT SYSTEM FROM EXHAUST ADAPTER

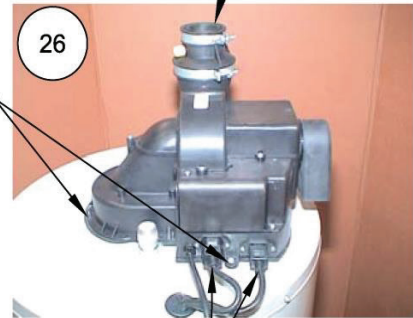

BLOWER MOUNTING SCREWS

BLOWER CORD SETS

FLUE BAFFLE

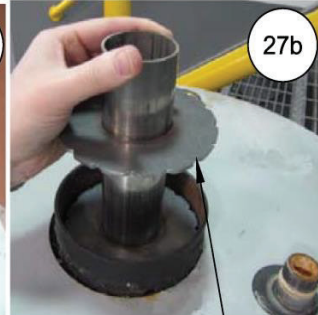
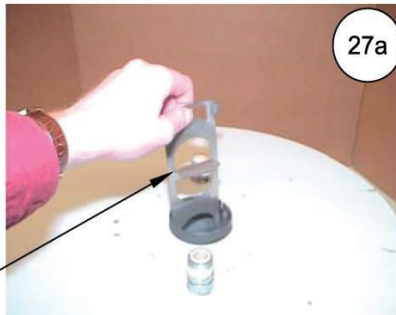

RG2PV50H
FLUE
CORE

FLUE TUBE
NOTCH

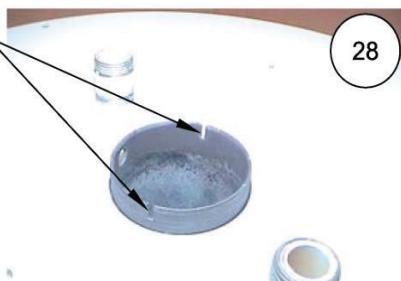

FLUE
BAFFLE SHOWN
INSTALLED IN
FLUE TUBE
NOTCHES



PV Series

PV SERVICE PROCEDURE XIII Inner Door/Gasket Removal, Inspection & Replacement

Inner Door Removal Procedure

- Step 1. Position gas control power switch to the "OFF" position.
- Step 2. Remove outer jacket burner access door.
- Step 3. Inner Door removal.
- Remove (2) 1/4" hex drive screws from right side inner door.
 - Remove (2) 1/4" drive screws from flange section of inner door.
 - Remove (2) 1/4" drive screws from left side inner door.
 - Remove inner door and inspect per step 4.

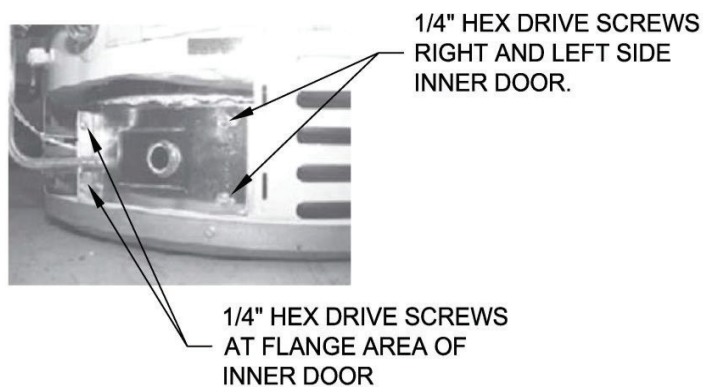

- Step 4. Fully inspect inner door gaskets for the following:
- Tears
 - Missing Material
 - Cracks
 - Dirt or debris
 - Other imperfections that will inhibit proper seal
 - Gasket adhesion to inner door
 - Material left on combustion chamber (around opening)

If the gasket is not affected by any of the above, gasket replacement is not required. If replacement is required, proceed to **Inner Door Gasket Replacement Procedure.**

Inner Door Gasket Replacement Procedure

⚠ WARNING

If the information in these instructions is not followed exactly, a fire or explosion may result causing property damage, personal injury or death.

- Step 5. After inspection of inner door as noted in step 4, completely remove gasket and adhesive residue from right and left side inner doors as needed.
- Step 6. Use RTV sealant (recommended bead size 1/8") to secure the inner door gasket to the inner door sections (right & left). Refer to illustration on next page for proper application. Note the overlap configuration in the flange area of the inner door. Set the flange section first, this will help to achieve the proper overlap position.

PV Series

PV SERVICE PROCEDURE XIII Inner Door/Gasket Removal, Inspection & Replacement

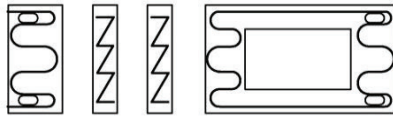

RECOMMENDED PATTERN FOR RTV SEALANT

GASKET OVERLAP MUST BE AS SHOWN $\pm 1/32$

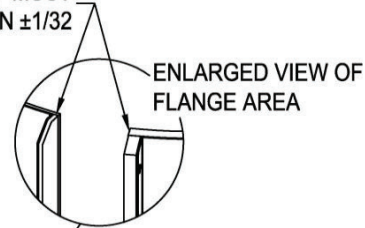

ENLARGED VIEW OF FLANGE AREA

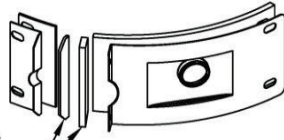

PLACE FLANGE SECTIONS FIRST

EXPANDED VIEW

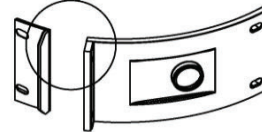

VIEW WITH GASKETS IN PLACE

Installation of Inner Door With Gasket

- Step 7. Clean any residual gasket residue or other debris from combustion chamber surface before installing the inner door/gasket assembly.
- Step 8. Place the left side inner door into position first. Firmly position the radiused channel of the inner door around the feedline. Using the $\frac{1}{4}$ " hex drive screws from step 3c, secure left side inner door in place. **DO NOT OVER TIGHTEN SCREWS**
- Step 9. Position pilot tube and igniter/sensor wire against left side inner door flange gasket. **DO NOT ROUTE THROUGH RADIUSED CHANNEL WITH FEEDLINE.**

⚠ WARNING

Stripped fastener connections may allow for seal breach of inner door. A seal breach may result in a fire or explosion causing property damage, personal injury or death. Do not over tighten screws in steps 8, 10 and 11.



RADIUSED CHANNEL FOR FEEDLINE

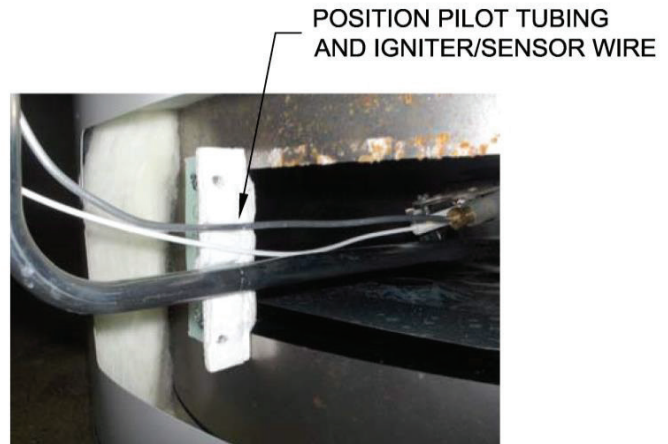

POSITION PILOT TUBING AND IGNITER/SENSOR WIRE

Installation of Inner Door With Gasket (cont.)

- Step 10. Firmly place right side inner door flange against the left side inner door flange and secure with (2) 1/4" hex drive screws from step 3b. **DO NOT OVER TIGHTEN SCREWS.**
- Step 11. Align right side inner door to combustion chamber and verify the fastener holes of the combustion chamber are aligned with right side inner door slotted opening. Verify seal integrity around combustion opening. Secure right side inner door using 1/4" hex drive screws from step 3a. **DO NOT OVER TIGHTEN SCREWS.** Verify both left and right sides of inner door are properly positioned and sealed against the combustion chamber.

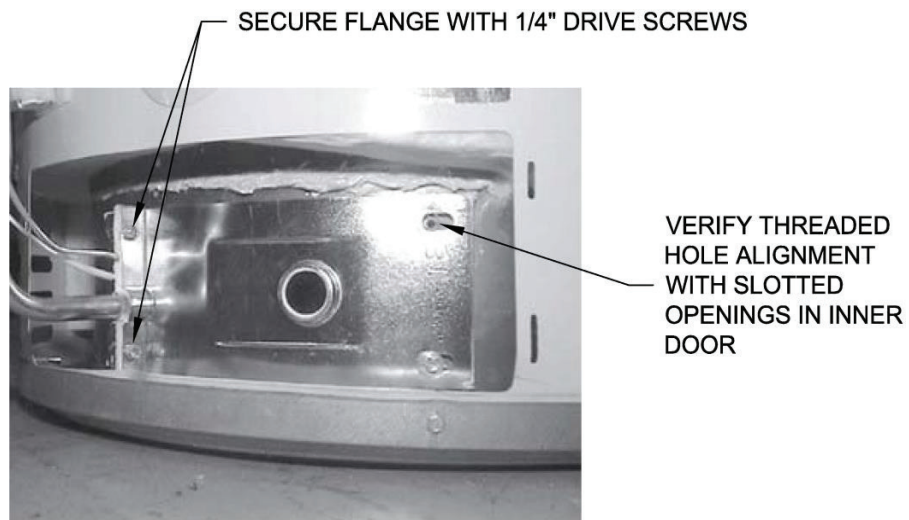

- Step 12. Replace outer jacket burner access door.
- Step 13. To resume operation follow the instructions located on the lighting instruction label or the lighting instructions located in the installation and operation manual.

ScreenLok® Flame Arrestor Cleaning

⚠ NOTICE

Some models are not equipped with the ScreenLok® Flame Arrestor.

- Step 1. Position Gas Control power switch to the “OFF” position.
- Step 2. Remove outer door.
- Step 3. Remove outer jacket door and inner door per service procedure XIII on page 39.
- Step 4. Disconnect main burner feedline (3/4” wrench), pilot tube (7/16” wrench) and igniter/flame sensor wire from gas control and remove burner assembly from combustion chamber.
- Step 5. Clean ScreenLok® Flame Arrestor using stiff brush, compressed air and/or shop vacuum to remove any scale or other debris accumulation. Using a soft brush, clear jacket openings from any dirt, dust, restrictions or other obstructions.
- Step 6. Remove any debris from burner assembly per PROCEDURE I and reinstall burner assembly into combustion chamber.
- Step 7. Reconnect feedline, pilot tube and igniter/flame sensor wire to the gas control
- Step 8. Reinstall outer jacket door and inner door per service procedure XIII on page 39.
- Step 9. To resume operation follow the instructions located on the lighting instruction label or the lighting instruction located in the installation and operation manual.

Frozen Exhaust Vent Terminal

If an exhaust vent terminal is blocked with ice or snow due to severe conditions, the pressure switch and control will not allow the burner to operate. This will result in a three flash error code. Once the blockage is removed (through melting or other means) the controls will let the burner operate. The position of the vent terminals in relation to each other and terminals from other appliances can have an effect on the potential for blockage due to ice or snow. See the installation instructions for recommended positioning of the terminals.

Glossary of Terms

BTU	British Thermal Units
GPM	Gallons per Minute
Hz	Hertz
kWhr	Kilowatt Hour
LED	Light Emitting Diode
NPT	National Pipe Thread
Ohms	Ohms of resistance
PSI	Pounds per Square Inch
RPM	Revolutions per minute
ECO	Energy Cut Out
VAC	Volts Alternating Current
" W.C.	Inches of Water Column
°C	Degrees Centigrade
°F	Degrees Fahrenheit

PV Series

PARTS LIST

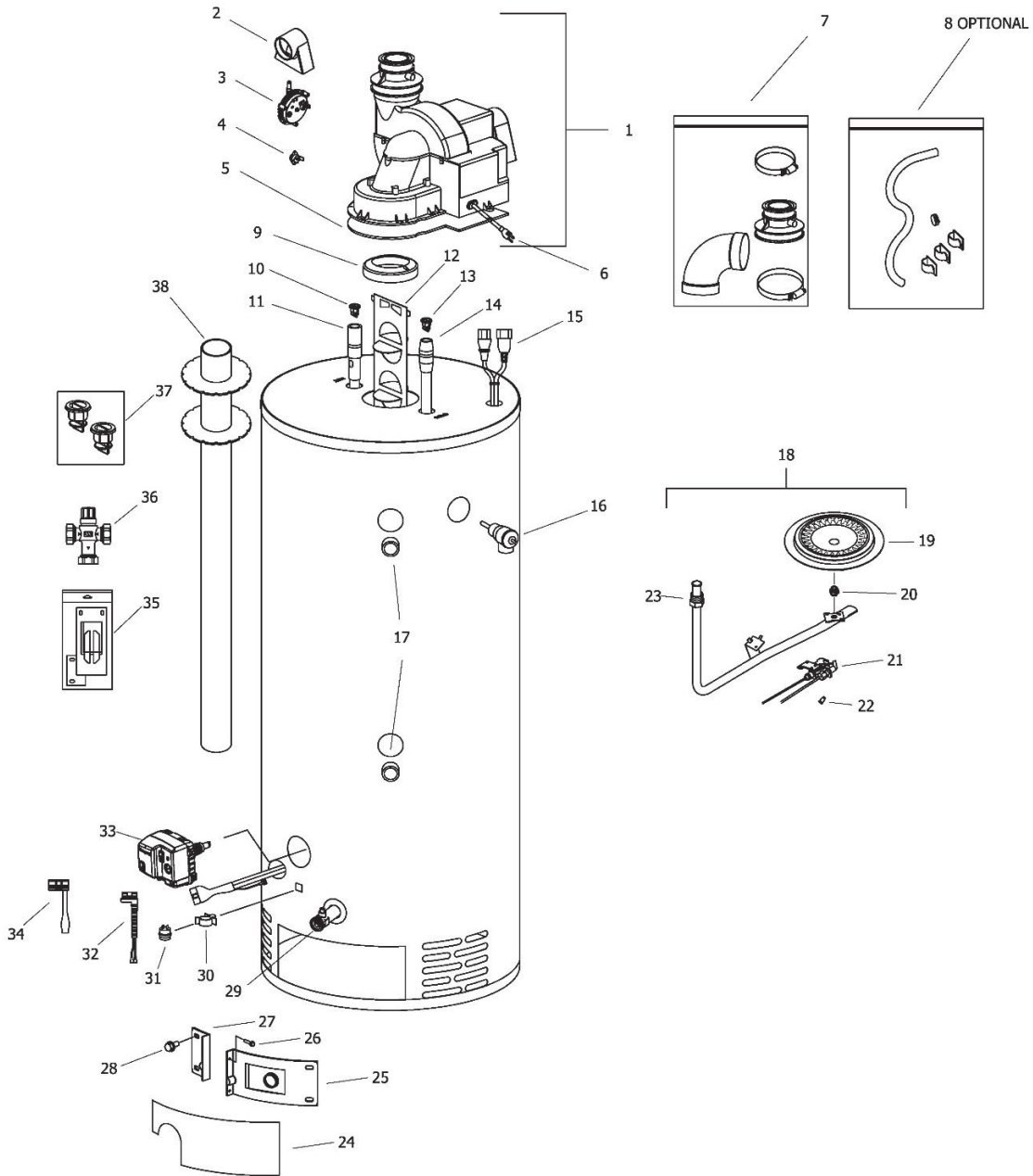

- 1. Blower Complete
- 2. Air Mixing Inlet Cover
- 3. Pressure Switch
- 4. Blower Temp. Switch
- 5. Blower Gasket
- 6. Blower Power Cord
- 7. Vent Adapter Kit
- 8. Condensate Hose Kit
- 9. Flue Reducer ("H" Models only)

- 10. Heat Trap Outlet
- 11. Hot Water Outlet Anode
- 12. Flue Baffle
- 13. Heat Trap Inlet
- 14. Inlet Dip Tube
- 15. Wire Harness
- 16. T&P Valve
- 17. 3/4 NPT Plug ("H" Models only)
- 18. Burner Assy.

- 19. Main Burner
- 20. Main Burner Orifice
- 21. Pilot Assy.
- 22. Pilot Orifice
- 23. Feedline
- 24. Outer Door
- 25. Right side Inner Door
- 26. Screw #8-15 x 3/4
- 27. Left Side Inner Door
- 28. Screw #10-12 x 3/4
- 29. Brass Drain Valve
- 30. FV Sensor Clip

- 31. FV Sensor
- 32. Sensor Harness (except 75 gal.)
- 33. Polymer Gas Control
- 34. Simulative Resistive Device (75 gal. only)
- 35. Inner Door Gasket Kit
- 36. ASSE Approved Mixing Valve
- 37. Kit-Heat Trap Insert
- 38. Flue Core ("55H" models only)



United States

Sales 800-523-2931

Technical Support 800-334-3393

Email techserv@bradfordwhite.com

Warranty 800-531-2111

Email warranty@bradfordwhite.com

Service Parts 800-538-2020

Email parts@bradfordwhite.com

Canada

Sales & Technical Support 866-690-0961 905-203-0600

Fax 905-636-0666

Warranty bwccwarranty@bradfordwhite.com

Technical Support bwccotech@bradfordwhite.com

Service Parts orders@bradfordwhitecanada.com

Orders ca.orders@bradfordwhite.com

For U.S. and Canada field service,
contact your professional installer or
local Bradford White sales representative.

International

General Contact international@bradfordwhite.com