

## INSTRUCTIONS FOR MODELS

VS-5000-E2  
VS-5000-E175  
VS-5000-E15

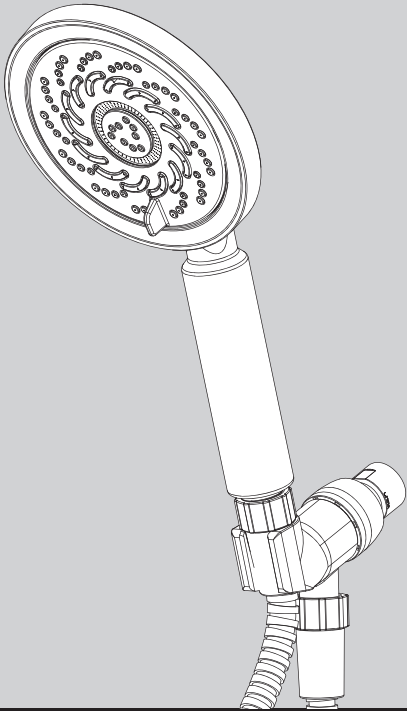

### NEED HELP?

For additional assistance or service please contact:

**SPEAKMAN®**

800-537-2107

customerservice@speakman.com

www.speakman.com

92-VS-5000-01

## TOOLS AND SUPPLIES

Thread Seal  
Tape  
(included)

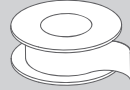

Adjustable  
Wrench



### IMPORTANT



Be sure to read instructions thoroughly before beginning installation. Do not overtighten any connections or damage may occur. This hand shower has an optimal operating range of 20-80 psi.

### SAFETY TIPS

Cover your drain to prevent loss of parts.

### MAINTENANCE

Periodic cleaning using a mild soap and warm water will help keep your Hand Shower's appearance in its original condition.

For best results, dry immediately with a soft, clean cloth. **DO NOT USE** harsh and/or abrasive cleaners.

On CHROME PLATED HAND SHOWERS, a two (2) part white vinegar, one (1) part water solution can be used to break down excessive mineral deposits on the sprays. Let the hand shower soak in the solution for about ½ hour then rinse thoroughly. Brush off any remaining mineral deposits if necessary.

**DO NOT USE** the vinegar/water treatment on any finish other than Chrome.

To reduce mineral build-up, turn the handle to FLOOD position to let the water drain out after every use.

### WARRANTY

Warranty information can be found at:  
[www.speakman.com](http://www.speakman.com)

- 1** Apply Thread Seal Tape to the outlet side of shower arm in a clockwise direction.

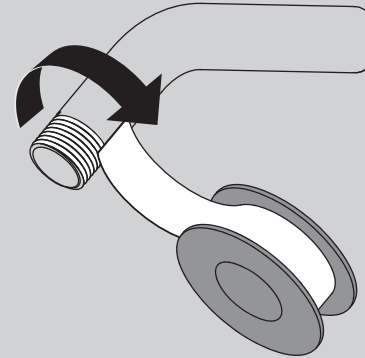

- 2** Thread Bracket onto shower arm by turning it in a clockwise direction. Tighten with adjustable wrench.

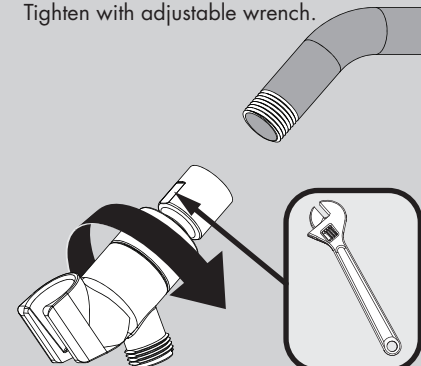

- 3** Ensure Hose Washer is inserted inside connector to avoid leaks. Thread Hose End with Label to the outlet port of Bracket. Hand tighten. **WATER WILL NOT FLOW THROUGH THE HOSE IF THE WRONG SIDE IS CONNECTED.**

**NOTE:** Label around hose shows this end assembles to water supply. Remove label before installation.

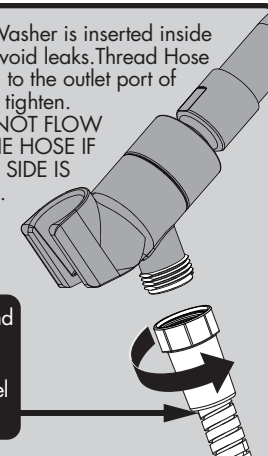

- 4** Ensure Hose Washer is inserted inside connector to avoid leaks. Thread remaining end of Hose to base of Hand Shower. Hand tighten.

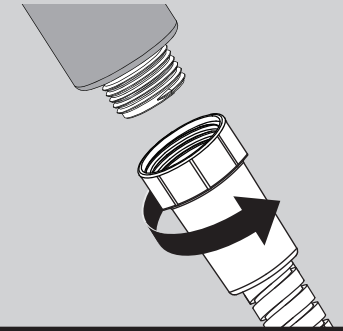

- 5** Place Hand Shower into Bracket. Turn on water supplies and check for leaks.

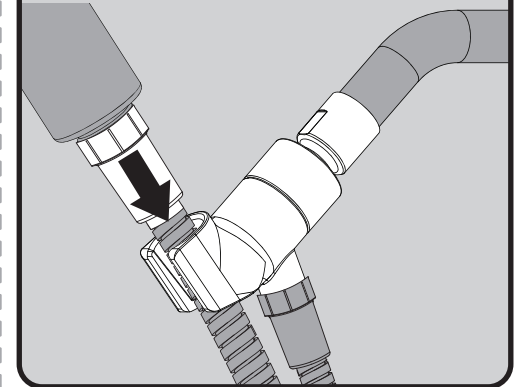

- 6** Rotate Spray Face to change Spray Settings.



## ROUGH IN DIMENSIONS

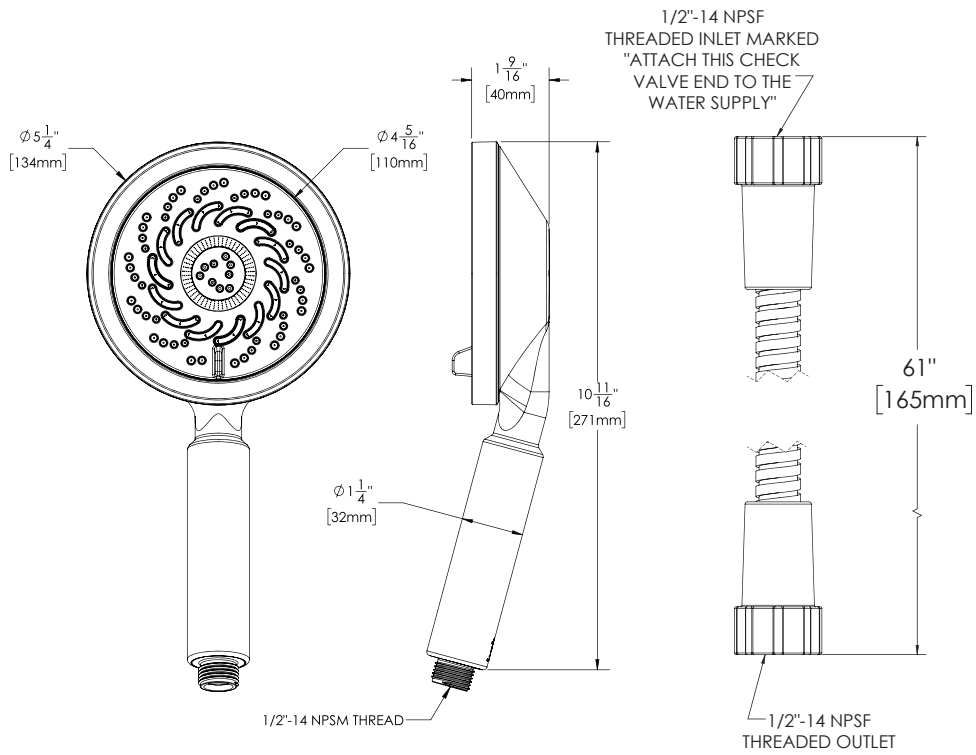

Model: VS-5000-E2

Max. Flow Rate: 2.0 gpm (7.6 L/min)

Min. Flow Rate: 1.75 gpm (6.6 L/min) @ 45 psi

FOR USE WITH AUTOMATIC COMPENSATING VALVES RATED AT 6.6 L/MIN (1.75 GPM) OR LESS.

Model: VS-5000-E175

Max. Flow Rate: 1.75 gpm (6.6 L/min)

Min. Flow Rate: 1.50 gpm (5.7 L/min) @ 45 psi

FOR USE WITH AUTOMATIC COMPENSATING VALVES RATED AT 5.7 L/MIN (1.50 GPM) OR LESS.

Model: VS-5000-E15

Max. Flow Rate: 1.5 gpm (5.7 L/min)

Min. Flow Rate: 1.3 gpm (4.9 L/min) @ 45psi

FOR USE WITH AUTOMATIC COMPENSATING VALVES RATED AT 4.9 L/MIN (1.3 GPM) OR LESS.

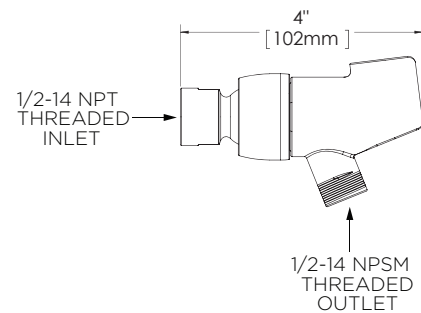

## REPAIR PARTS

