

# >B< MaxiPro

Air Conditioning and Refrigeration



>B< MaxiPro Technical Brochure

# Join the Press Revolution

## Over 110 years of innovation

Conex Bänninger specializes in providing fittings, valves and accessories across the globe by offering innovative and versatile solutions. Since 1909, Conex Bänninger has produced over 22 billion fittings and valves and has built its reputation for quality European manufacturing, backed by first class customer service and unrivalled expertise.

Passionate about excellence, Conex Bänninger is a byword for quality in the domestic, commercial, industrial, shipbuilding, air conditioning and refrigeration markets worldwide. Conex Bänninger is an ISO 9001 company, which assures their customers of consistency in the quality of their services and products.



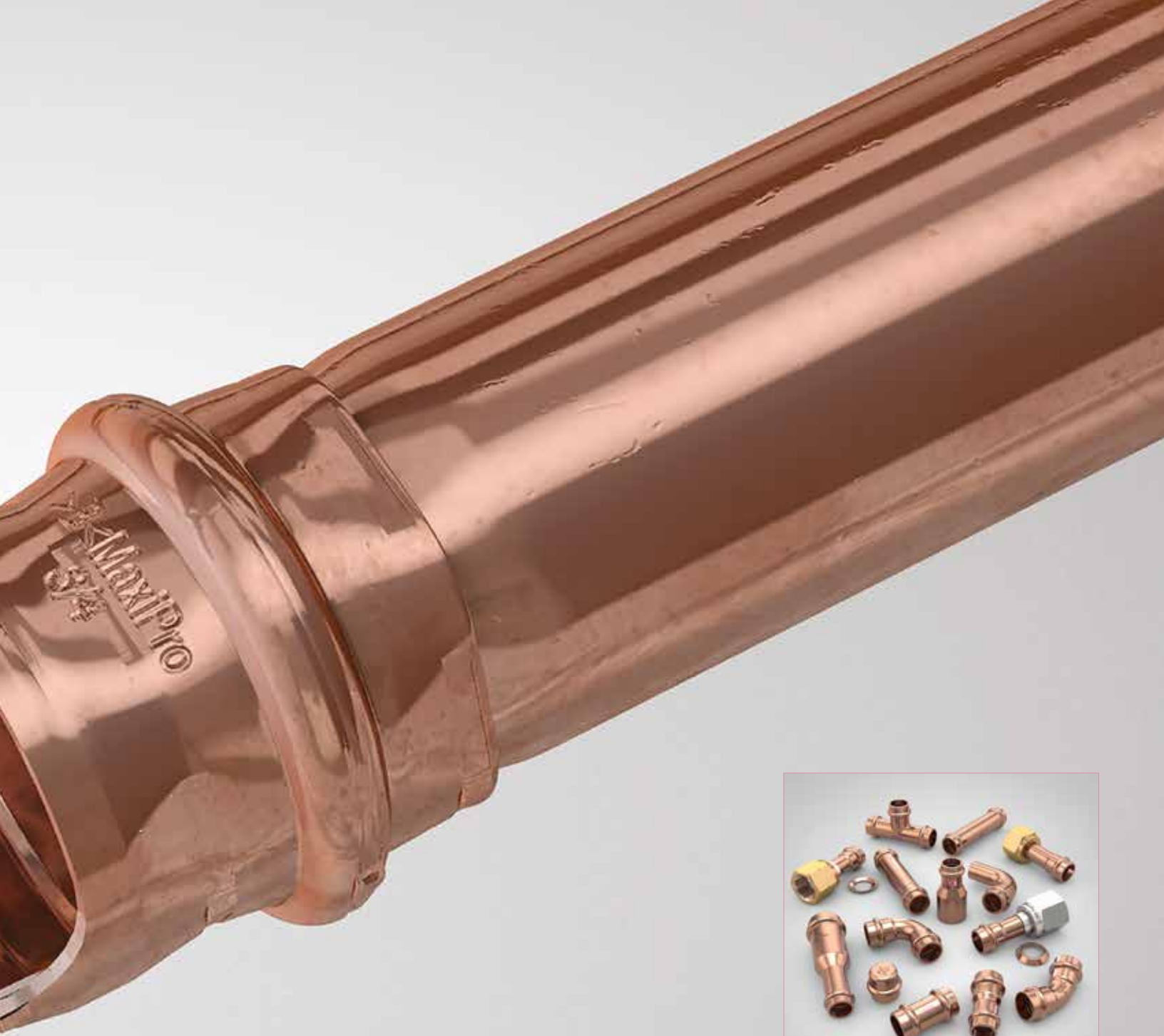

>B< **MaxiPro** is a press fitting system for use with hard, half hard or annealed copper tube conforming to ASTM-B280, ASTM-B88 type K or L and ASTM B1003.

>B< **MaxiPro** provides a secure, permanent leak-proof joint suitable for air conditioning and refrigeration applications.

## Contents

1	Applications .....	1
2	Features and Benefits .....	2
3	Technology - 3 Point Press .....	3
4	Technical Data .....	4
5	Quality Assurance .....	4
6	Trademarks and Patents .....	4
7	Size Availability .....	4
8	Fitting Material .....	4
9	Approvals, Standards and Code Compliance .....	4
10	Fittings Storage .....	5
11	Marking and Cleanliness .....	5
12	Design Considerations .....	5
	12.1 Pipework support	
	12.2 Pipework protection	
	12.3 Pipework identification and insulation	
	12.4 Electrical continuity	
	12.5 Space required for the pressing process	
	12.6 Minimum distances between pressings and insertion depth	
	12.7 Minimum distance for press fittings from an existing brazed joint	
	12.8 Minimum brazing distance to an existing pressed fitting	
	12.9 Minimizing pressure drop with long radius elbows	
	12.10 Testing and commissioning of air conditioning and refrigeration systems	
	12.11 >B< MaxiPro tube compatibility table	
13	>B< MaxiPro Installation Process .....	9
14	Press Tool and Jaw Compatibility .....	12
	14.1 Press Tool and Jaw Compatibility 24 kN	
	14.2 Press Tool and Jaw Compatibility 32 kN	
15	>B< MaxiPro Product Range .....	13
16	Fifteen-Year Limited Warranty .....	20
17	Abbreviations .....	21
18	Frequently Asked Questions .....	22

# 1. Applications

>B< MaxiPro fittings are designed for the following applications:

- Refrigeration
- Air conditioning
- Heat pump (refrigeration side)



## 2. Features and Benefits

<b>Flame-free:</b>	Flame-free installation avoids the need for a fire permit and the risk of fire on site.
<b>No nitrogen purge:</b>	>B< MaxiPro is a mechanical joint, thus eliminating the need for nitrogen purge during the jointing process.
<b>Lower installed cost:</b>	A professional fitting which is quick and simple to install, saving time and money.
<b>Higher productivity, improved flexibility:</b>	Work may be completed during working hours / public access, by a single employee.
<b>Site access:</b>	Easy access to work sites, no gas bottles required.
<b>Quality designed in:</b>	Reliable, repeatable, permanent, tamper-proof connections every time.
<b>3-point press:</b>	Three press points, one each side of the bead, and one press compressing the O-ring. This provides a permanent and secure joint.
<b>High quality O-ring:</b>	A high quality HNBR O-ring forms a secure leak-free joint when pressed.
<b>Protected O-ring:</b>	Lead-in edge design aids tube insertion and helps protect the O-ring from damage or displacement.
<b>Fitting identification:</b>	Fittings are marked >B< MaxiPro and identified with a pink mark indicating their suitability for high pressure air conditioning and refrigeration applications.
<b>Electrical continuity:</b>	Maintains ground continuity without the need for additional ground continuity straps.
<b>Certification:</b>	>B< MaxiPro fittings are UL 207 recognized and listed, refrigerant fitting report reference SA44668, approved use for field and factory installations.
<b>Field proven:</b>	Press fit technology, field proven over two decades and millions of installed fittings worldwide.
<b>Warranty:</b>	>B< MaxiPro fittings are covered by a fifteen (15) year limited warranty. Please refer to full terms and conditions, see section 16.
<b>Support:</b>	Backed by Conex Bänninger's experienced technical support and customer service teams.
<b>Compact tooling:</b>	Light compact tooling provides easy access to tightly spaced tube runs.
<b>Tooling:</b>	Conex Bänninger recommends the use of ROTHENBERGER press tools.

### 3. Technology 3-Point Press

>B< MaxiPro benefits from a 3-point press - three press points; one on each side of the bead and one press compressing the O-ring. This provides a permanent and secure joint.

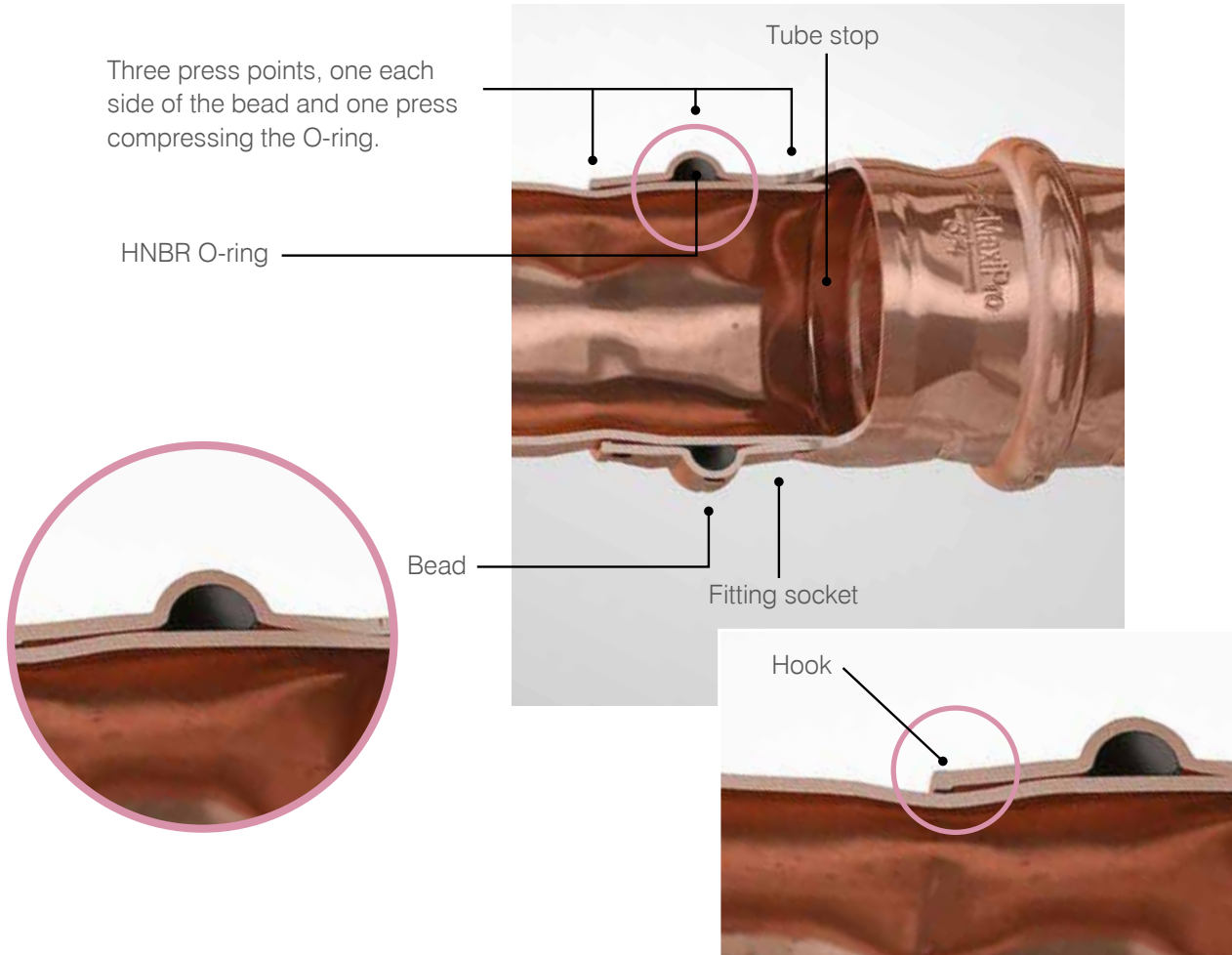

On fittings 1/2" and upwards, a hook ensures that the high pressure performance achieved by >B< MaxiPro fittings is maintained.



## 4. Technical Data

Table 1

Technical Data	
Parameters	Capability
Applications	Air conditioning, refrigeration, heat pump (refrigerant side)
Connections	Copper to copper
Approved tube: Copper tube conforming to*	ASTM-B280, ASTM-B88 type K or L, ATSM B1003
Fitting / tube range	1/4", 3/8", 1/2", 5/8", 3/4", 7/8", 1", 1 1/8", 1 3/8"
Fitting material	Refrigerant grade copper (UNS C12200 min 99.9% pure)
O-ring	HNBR
Approved oils	POE, PAO, PVE, AB and MO
Maximum operating and abnormal pressure	700 psi / 48 bar / 4800 kPa
Burst pressure >3 x maximum operating and abnormal pressure	>2100 psi / >144 bar / >14400 kPa
Leak tightness	Helium $\leq 7.5 \times 10^{-7}$ Pa.m <sup>3</sup> /s at +20 °C, 10 bar
Vacuum	200 microns
O-ring temperature range	-40 °F to 284 °F / -40 °C to 140 °C
UL 207 recognized and listed continuous operating temperature	-40 °F to 250 °F / -40 °C to 121 °C
Compatible refrigerants	R-125, R-134a, R-404A, R-407A, R-407C, R-407F, R-407H, R-410A, R-417A, R-421A, R-422B, R-422D, R-427A, R-438A, R-448A, R-449A, R-450A, R-452A, R-452C, R-507A, R-513A, R513B, R-515B, R-718, R-424A, R-434A, R-437A, R-453A, R-456A, R-513, Ethylene Glycol and HYCOOL 20. Please refer to refrigerants chart on the <a href="#">website</a> .

\*Please refer to >B< MaxiPro Tube Compatibility Table, see section 12.10.

**Note:** >B< MaxiPro fittings are NOT suitable for R-717, R-723, R-764, R-744, R-22 refrigerants. Please check our website: <https://conexbanninger.com/en-us/> for updates on the >B< MaxiPro range.

## 5. Quality Assurance

Conex Bänninger is an ISO 9001 quality assured company. We are committed to providing quality products and support to our customers.

## 6. Trademarks and Patents

>B< MaxiPro is a registered trademark in numerous territories worldwide. For information on >B< MaxiPro patents visit: <https://conexbanninger.com/en-us/>.

## 7. Size Availability

>B< MaxiPro is available in the following sizes 1/4", 3/8", 1/2", 5/8", 3/4", 7/8", 1", 1 1/8", 1 3/8" (see range details).

## 8. Fitting Material

>B< MaxiPro is manufactured from refrigerant grade copper (UNS C12200 min 99.9% pure).

## 9. Approvals, Standards and Code Compliance

- >B< MaxiPro fittings are UL 207 recognized and listed, refrigerant fitting report reference SA44668, approved use for field and factory installations.
- UL 109 - 8 Vibration test, compliant.
- UL 1963 - 79 Tests of gaskets and seals used in refrigerant systems, compliant.
- ISO 5149-2:2014, Refrigerating systems and heat pumps - Safety and environmental requirements - Part 2: Design, construction, testing, marking and documentation compliant.
- ISO 5149-2, 5.3.2.2.3 Strength pressure test, compliant.
- ISO 14903 - 7.4 Tightness test, compliant.
- ISO 14903 - 7.6 Pressure temperature vibration tests (PTV), compliant.
- ISO 14903 - 7.8 Freezing test, compliant.
- ASTM G85 salt spray (fog) compliant.
- ASHRAE 15 - 2016 Safety Standard for Refrigeration Systems, compliant.
- ASME B31.5 - 2016 Refrigeration Piping and Heat Transfer Components, compliant.
- 2021, 2018, 2015, 2012, 2009 and 2006 International Mechanical Code (IMC), certified, ICC-ES, PMG-1440.
- 2021, 2018, 2015, 2012, 2009 and 2006 International Residential Code (IRC), certified, ICC-ES, PMG-1440.
- 2021, 2018, 2015, 2012, 2009 and 2006 Uniform Mechanical Code (UMC), certified, ICC-ES, PMG-1440.
- 2019, 2016, 2013, and 2010 California Mechanical Code (CMC), Certified, ICC-ES, PMG-1440.

Mechanical joints shall not be used on annealed temper copper tube in sizes larger than 7/8 inch (22.2 mm) OD size per International Mechanical Code (IMC) and 3/4 inch nominal size per Uniform Mechanical Code (UMC).



## 10. Fittings Storage

>B< MaxiPro fittings should be kept in the re-sealable bags that they are sold in and stored out of direct sunlight until ready for use. Any unused fittings should be left sealed in the bag until required.

The O-rings should be protected from light sources, in particular direct sunlight or intense artificial light having a high ultraviolet content.

As the ozone is particularly harmful to rubber, storage rooms should not contain any equipment that is capable of generating ozone, such as mercury vapor lamps or high-voltage electrical equipment giving rise to electric sparks or silent electrical discharges.

Combustion gases and organic vapors should be excluded from storage rooms, as they may give rise to ozone via photochemical processes. Precautions should also be taken to protect stored products from all sources of ionizing radiation.

>B< MaxiPro fittings should be kept in their sealed bags to protect them from contamination.

## 11. Marking and Cleanliness

Each fitting is marked >B< MaxiPro, size and 48 bar (on a pink background) and are cleaned, bagged and labeled to fully comply with the cleanliness requirements of ASTM-B280 and ASTM-B88 type K or L. Keep the ziplock bag sealed to protect fittings from contamination.

## 12. Design Considerations

All refrigeration pipelines must be designed so that the number of joints is kept to a practical minimum. Refrigeration pipelines should be designed in compliance with the following key standards and in line with federal, state and local regulations, codes of practice and bylaws governing the installation. All applicable health and safety practices must be adhered to.

- ASHRAE 15 - 2016  
Safety Standard for Refrigeration Systems.
- ASME B31.5 - 2016  
Refrigeration Piping and Heat Transfer Components.
- 2021, 2018, 2015, 2012, 2009 and 2006  
International Mechanical Code (IMC).
- 2021, 2018, 2015, 2012, 2009 and 2006  
International Residential Code (IRC) .

- 2021, 2018, 2015, 2012, 2009 and 2006  
Uniform Mechanical Code (UMC).
- 2019, 2016, 2013, and 2010  
California Mechanical Code (CMC).

### 12.1 Pipework support

All pipework should be supported by the use of appropriate clips, brackets or supports. Please refer to:

- ASHRAE 15 - 2016  
Safety Standard for Refrigeration Systems.
- ASME B31.5 - 2016  
Refrigeration Piping and Heat Transfer Components.
- 2021, 2018, 2015, 2012, 2009 and 2006  
International Mechanical Code (IMC).
- 2021, 2018, 2015, 2012, 2009 and 2006  
International Residential Code (IRC).
- 2021, 2018, 2015, 2012, 2009 and 2006  
Uniform Mechanical Code (UMC).
- 2019, 2016, 2013, and 2010  
California Mechanical Code (CMC).

Federal, state and local regulations, codes of practice and bylaws governing the installation must also be adhered to. Supports should be placed near to fittings when possible and additional supports may be required when using soft copper tubes or where vibration occurs.

### 12.2 Pipework protection

Tubing and fittings shall be protected as far as possible against adverse environmental or other external effects. Refer to:

- ASHRAE 15 - 2016  
Safety Standard for Refrigeration Systems.
- ASME B31.5 - 2016  
Refrigeration Piping and Heat Transfer Components.
- 2021, 2018, 2015, 2012, 2009 and 2006  
International Mechanical Code (IMC).
- 2021, 2018, 2015, 2012, 2009 and 2006  
International Residential Code (IRC).
- 2021, 2018, 2015, 2012, 2009 and 2006  
Uniform Mechanical Code (UMC).
- 2019, 2016, 2013, and 2010  
California Mechanical Code (CMC).

Federal, state and local regulations, codes of practice and bylaws governing the installation must also be adhered to.

## 12.3 Pipework identification and insulation

All pipework must be installed in accordance with:

- ASHRAE 15 - 2016 Safety Standard for Refrigeration Systems.

## 12.5 Space required for the pressing process

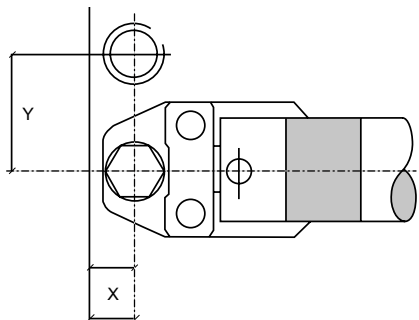

Table 2

Space required for completing a pressing between tubes and wall				
Inch tubes - fittings nominal OD	X	X	Y	Y
Inches	mm	Inches	mm	Inches
1/4"	30	1 1/4"	60	2 3/8"
3/8"	30	1 1/4"	60	2 3/8"
1/2"	30	1 1/4"	60	2 3/8"
5/8"	30	1 1/4"	60	2 3/8"
3/4"	30	1 1/4"	60	2 3/8"
7/8"	35	1 3/8"	60	2 3/8"
1"	35	1 3/8"	60	2 3/8"
1 1/8"	35	1 3/8"	60	2 3/8"
1 3/8"	35	1 3/8"	60	2 3/8"

## 12.4 Electrical continuity

>B< MaxiPro fittings maintain ground continuity without the need for additional ground continuity straps.

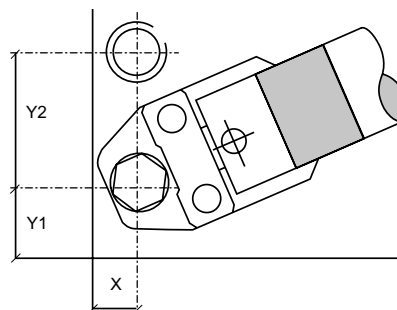

Table 3

Space required for completing a pressing between tubes and wall corner						
Inch tubes - fittings nominal OD	X	X	Y1	Y1	Y2	Y2
Inches	mm	Inches	mm	Inches	mm	Inches
1/4"	50	2"	50	2"	100	4"
3/8"	50	2"	50	2"	105	4 1/4"
1/2"	50	2"	50	2"	110	4 3/8"
5/8"	50	2"	50	2"	110	4 3/8"
3/4"	50	2"	50	2"	110	4 3/8"
7/8"	60	2 3/8"	60	2 3/8"	120	4 3/4"
1"	60	2 3/8"	60	2 3/8"	120	4 3/4"
1 1/8"	60	2 3/8"	60	2 3/8"	120	4 3/4"
1 3/8"	60	2 3/8"	60	2 3/8"	120	4 3/4"

## 12.6 Minimum distances between pressings and insertion depth

Due to the reforming of the tube profile when pressed, it is advised that a minimum distance is allowed between each fitting.

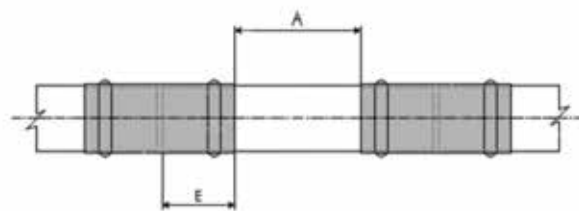

Table 4

Minimum distances between pressings and insertion depth				
Nominal size - inches	Minimum distance - A mm	Minimum distance - A inches	Insertion depth - E mm	Insertion depth - E inches
1/4"	10	1/2"	18.0	0.71
3/8"	10	1/2"	18.0	0.71
1/2"	15	5/8"	19.0	0.75
5/8"	15	5/8"	22.0	0.87
3/4"	20	7/8"	23.0	0.91
7/8"	20	7/8"	25.0	0.98
1"	25	1"	24.0	0.94
1 1/8"	25	1"	26.5	1.04
1 3/8"	35	1 3/8"	34.0	1.34

## 12.7 Minimum distance for press fittings from an existing brazed joint

To ensure proper sealing of both the brazed and >B< MaxiPro fitting the following minimum distances must be maintained between the two fittings.

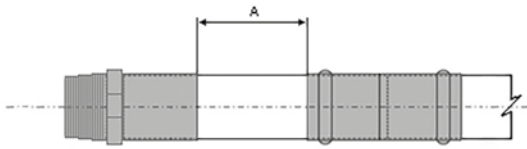

Table 5

Minimum distance from a brazed joint		
Nominal size tube OD	Minimum distance A	Minimum distance A
Inches	mm	Inches
1/4"	10	1/2"
3/8"	10	1/2"
1/2"	15	5/8"
5/8"	15	5/8"
3/4"	20	7/8"
7/8"	20	7/8"
1"	25	1"
1 1/8"	25	1"
1 3/8"	35	1 3/8"

Note: A - clearance between fitting ends

It is important that there is no residual brazing or other foreign debris on the tubing to be inserted into the >B< MaxiPro fitting. The surface condition on the area of press joint should be clean and free from debris and comply with ASTM-B280 or ASTM-B88 type K or L.

## 12.9 Minimizing pressure drop with long radius elbows

Some applications are more sensitive to pressure losses, to minimize pressure drop use long radius elbows.

The table below details the equivalent length of tube for short radius versus long radius elbows, long radius elbows have a shorter equivalent length of tube than short radius elbows, giving a smaller pressure loss.

Table 7

Fitting Size Tube Nominal OD Inches	Elbow Equivalent Lengths of Tube			
	Elbows 90° Brazing Equivalent Length of Tube inches		>B< MaxiPro 90° Elbows Equivalent Length of Tube inches	
	Standard Radius	Long Radius	Standard Radius	Long Radius
1/4"	1	0.7	0.7	*
3/8"	1.2	0.8	0.8	*
1/2"	1.4	0.9	1.2	0.7
5/8"	1.6	1	1.3	0.8
3/4"	1.8	1.2	1.5	1
7/8"	2	1.4	1.7	1.1
1 1/8"	2.6	1.7	2.2	1.4
1 3/8"	3.3	2.3	2.8	1.8

The ratio of fitting bend to tube dia (R/D) for short radius 90° elbows is approximately 1.0

The ratio of fitting bend to tube dia (R/D) for long radius 90° elbows > 1.5

\* 1/4" and 3/8" >B< MaxiPro 90° elbows meet the requirements of long radius elbows as there R/D ratio is > 1.5.

## 12.8 Minimum brazing distance to an existing pressed fitting

**Caution** – Brazing near to >B< MaxiPro joints should be avoided as this may cause the seal to degrade due to heat transfer. The table below states the minimum distance away from the press joint which is acceptable to braze. If this distance cannot be maintained then adequate precautions must be taken such as fabricating the brazed section prior to assembly with the press fittings, wrapping in a wet rag or applying a heat barrier spray, gel or putty, to prevent heat transfer to the press fitting during brazing.

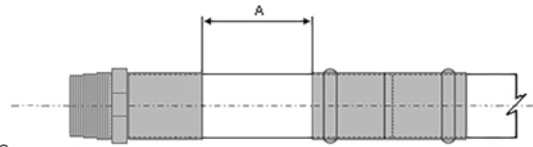

Table 6

Minimum distance brazing		
Nominal size tube OD	Minimum distance A	Minimum distance A
Inches	mm	Inches
1/4"	250	10"
3/8"	300	12"
1/2"	350	13 3/4"
5/8"	450	17 3/4"
3/4"	500	19 3/4"
7/8"	600	23 3/4"
1"	650	24 1/2"
1 1/8"	700	27 1/2"
1 3/8"	900	35 1/2"

Note: A - clearance between fitting ends

## 12.10 Testing and commissioning of air conditioning and refrigeration systems

Testing and commissioning of air conditioning and refrigeration systems should be in accordance with the requirements specified in:

- ASHRAE 15 - 2016  
Safety Standard for Refrigeration Systems.
- ASME B31.5 - 2016  
Refrigeration Piping and Heat Transfer Components.
- 2021, 2018, 2015, 2012, 2009 and 2006  
International Mechanical Code (IMC).
- 2021, 2018, 2015, 2012, 2009 and 2006  
Uniform Mechanical Code (UMC).
- 2019, 2016, 2013, and 2010  
California Mechanical Code (CMC).

Federal state and local regulations, codes of practice and bylaws governing the installation must also be adhered to.

### General

- Dry oxygen free nitrogen (OFN) should be used for tightness and strength testing as it is inert. Do not use oxygen for pressure testing, under pressure it can react violently with hydrocarbons (oil and grease) resulting in explosions and fire.
- The maximum test pressure to be identified by the installer. This will be calculated from the system pressure and the test parameters.
- To ensure >B< MaxiPro fittings are tested safely, during the strength pressure and / or tightness test, the pressure should be raised gradually up to the desired test pressure of the system as established by the installer.

- If you are going to leave the pipework pressurized for 24 hours or longer to check for leaks, measure the system pressure and the ambient temperature at the start and finish of the tightness test. A rise in ambient temperature can mask a leak if this is not taken into account. There will be a pressure change of approximately 10 psi with a temperature change of 9 °F.
- Care must be taken to ensure a >B< MaxiPro joint will not be close enough to the liquid charging point that the temperature of the joint drops below -40 °F when breaking a vacuum by liquid charging the system.

### Problem Solving Vacuum Evacuation

Vacuum evacuation removes air, moisture, and non-condensable gases prior to system charging.

Failure to achieve a vacuum:

- A leak or moisture in the system (see below).
- Vacuum pump not working correctly.
- Vacuum pump does not have sufficient capacity.

Failure to hold a vacuum:

- A leak in the system or the connections to the system – find all leaks and repair them.  
– An ultrasonic leak detector can help pinpoint leaks on a system under vacuum.
- Moisture or refrigerant still in the system – continue evacuation.

No remedial action e.g. cutting out fittings from the system should be taken until a proper fault finding exercise has been completed.

## 12.11 >B< MaxiPro tube compatibility table

Table 8

>B< MaxiPro fitting size	Tube size Nominal OD		ASTM B280 - ASTM B88 - ASTM B743 - ASTM B1003												
			Nominal wall thickness												
	Inch	mm	0.025"	0.030"	0.031"	0.035"	0.040"	0.042"	0.045"	0.049"	0.050"	0.055"	0.06"	0.065"	0.072"
1/4	0.250"	6.35	■	●											
3/8	0.375"	9.53		● ■	●	● ■									
1/2	0.500"	12.70			●	● ■				● ■					
5/8	0.625"	15.88				●	● ■			● ■					
3/4	0.750"	19.05				●		● ■		● ■					
7/8	0.875"	22.23							● ■					● ■	
1 1/8	1.125"	28.58									■			■	
1 3/8	1.375"	34.93										■		■	

- Coil lengths in annealed condition.
- Straight lengths in hard/half hard condition.

### Notes Table 8:

- Ensure coil tubes are in round condition. Oval tubes should be rerounded.
- Hardness tolerance as per approved standards in the table 8 above.
- It is the engineer's responsibility to ensure that the tube selected is compatible with >B< MaxiPro and meets the operating pressure requirements of the system.

Please check our website: <https://conexbanninger.com/en-us/> for updates.

## 13. >B< MaxiPro Installation

**General:** Conex Bänninger >B< MaxiPro fittings must be installed by an installer who is appropriately trained and qualified to work on air conditioning and refrigeration installations and certified via the >B< MaxiPro training course. All installations must be completed in line with local regulations and bylaws governing the installation, and all applicable health and safety practices must be adhered to. When using the press tools, care must be taken to ensure hands are kept away from the jaw during the pressing process. Always wear ear and eye protection.

**Important:** Select the correct size of tube, fitting and jaw for the job. Ensure the fitting and tube are kept free of any dust or dirt and that the O-ring is undamaged. Check the inner pressing contour of the jaw is free of dirt and debris. Do not force tube ends together prior to making joints. Joints should only be made on an unstressed pipework assembly.

**Remarks:**

- A joint is finished after one complete compression cycle of the tool.
- Do not press any >B< MaxiPro fitting more than once.
- Pipework alignment must be completed prior to pressing.
- Do not rotate joints after they have been pressed.

**Copper tube compatibility:** Please refer to tube compatibility table, section 12.10.

**Maximum operating pressure:** 700psi, 48 bar, 4,800 kPa.

**Operating temperature range:** -40 °F to 250 °F, -40°C to 121°C.

**Compatible refrigerants:** R-125, R-134a, R-404A, R-407A, R-407C, R-407F, R-407H, R-410A, R-417A, R-421A, R-422B, R-422D, R-427A, R-438A, R-448A, R-449A, R-450A, R-452A, R-452C, R-507A, R-513A, R513B, R-515B, R-718, R-424A, R-434A, R-437A, R-453A, R-456A, R-513, Ethylene Glycol and HYCOOL 20.

Please refer to refrigerants chart on the [website](#).

**Note:** >B< MaxiPro fittings are **NOT** suitable for **R-717, R-723, R-764, R-744, R-22** refrigerants.

**Compatible oils:** POE, PAO, PVE, AB and MO.



## Making a joint with a >B< MaxiPro press fitting



1. Cut the tube to length

- Use a rotary tube cutter.
- Ensure that the tube is cut square.
- Check the tube has retained its shape and is damage free.



2. Deburr and remove all external sharp edges

- Deburr the tube both internally and externally.
- Where possible angle the tube downwards to prevent filings entering the tube.
- Use a pencil type deburrer on internal tube edges.
- Make sure the internal and external surfaces of the tube ends are smooth and free from burrs or sharp edges.



3. Use a pencil type deburrer on internal edges



4. Clean the tube end

- Thoroughly clean the tube end using ROTHENBERGER ROVLIES or similar cleaning pad in a rotating action.
- Tube ends must be free from scratches, oxidation, dirt and debris.



5. Check for defects

- If deep scratches are still visible, cut the tube back to a clean section and prepare the tube end again.



6. Ensure the O-ring is seated

- Check the fitting is the correct size for the tube.
- Check the O-rings are present and correctly seated.
- It is good practice to add a small amount of Conex Bänninger press fitting lubricant to the O-rings to aid tube insertion.



7A. Mark insertion depth on tube using depth gauge

- Insert tube into correct socket in depth gauge.
- Check window to see the tube is fully inserted.
- Mark the insertion depth on the tube.



7B. Alternatively insert tube to tube stop and mark

- The tube must be fully inserted into the fitting until it reaches the tube stop.
- To reduce the risk of dislodging the O-ring rotate the tube (if possible) while slipping it into the fitting.
- Mark the insertion depth on the tube.



7B. Check the depth mark

- Remove the tube and align with fitting socket, check that the depth mark is correctly positioned.
- The insertion depth mark is used as a reference prior to pressing the joint.



8. Insert the tube fully into the fitting. Ensure tube is fully inserted prior to pressing

- Insert the tube fully into the fitting up to the tube stop.
- To reduce the risk of dislodging the O-ring rotate the tube (if possible) while slipping it into the fitting.
- Prior to pressing, ensure the tube has not moved out from the fitting socket.
- Use the insertion depth mark as a guide.

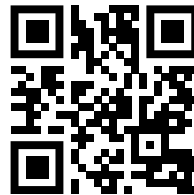

Use the QR code app on your smart phone or tablet to access [www.conexbanninger.com](http://www.conexbanninger.com)

### 1/4" to 1 1/8"



1. Align jaws square on the fitting

- Ensure pipework is correctly aligned prior to pressing.
- Ensure the correct size jaw is inserted into the tool.
- The jaws must be placed squarely on the fitting locating the groove on the bead.
- The bead on the fitting should fit centrally in the groove of the jaw.



2. Complete the joint with the approved tool. Press once only

- Depress and hold the button to complete the pressing cycle.
- Pressing is complete when the jaws are fully closed and the piston retracts.
- Complete the press cycle once only – do not repress.
- Release the jaws from the pressing.



3. Mark the completed joint

- Mark the completed joint after pressing.
- This enables joints to be inspected easily before testing and insulating the pipework.

1 3/8"



1. Fit the pressing ring

- Using the appropriate size pressing ring, open, and locate onto the fitting bead.
- Close the pressing ring fully



2. Engage actuator

- With the actuator jaw fitted in the press tool, open the actuator and locate it into the aperture of the pressing ring.
- Check for any tube movement prior to pressing



3. Complete the joint with the press tool

- Press and hold the trigger/ button on the press tool to begin the pressing cycle.
- The tool automatically stops when the cycle has been completed.

**IMPORTANT: The joint is complete after one full cycle. DO NOT crimp any fitting more than once.**

## Installing a >B< MaxiPro female flare connector to a male flare connector.

Make the flare connection prior to pressing the >B< MaxiPro joint. If this is not possible care must be taken to prevent rotational forces being applied to the pressed joint.

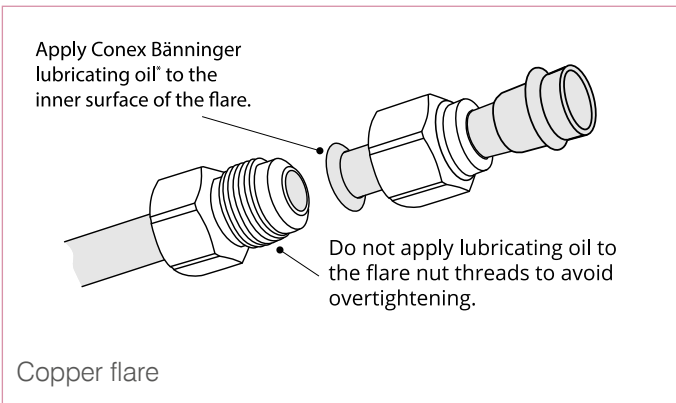

Align the centers of both flares and tighten the flares by hand.

**\*Note:** A compatible refrigerant oil may be used if Conex Bänninger lubricating oil is not available.

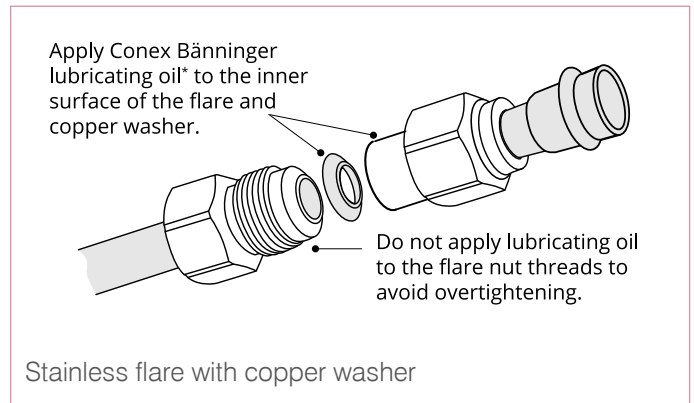

Align the centers of both flares and tighten the flares by hand.

**\*Note:** A compatible refrigerant oil may be used if Conex Bänninger lubricating oil is not available.

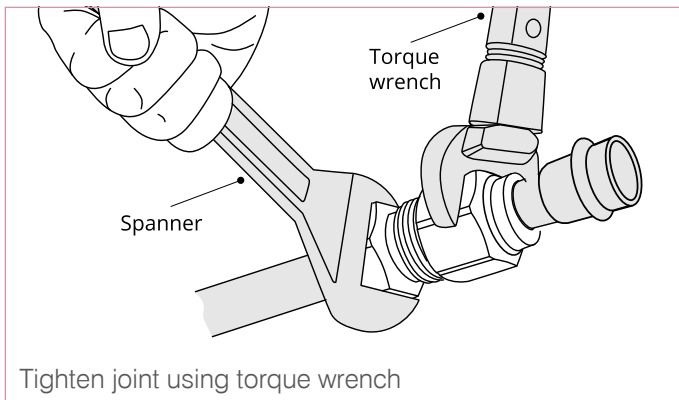

Fully tighten using spanner and torque wrench to the torque values set out in table 9. **Do not over tighten.**

Table 9

Flares Tightening Torque		
Size	N m	ft lbf
1/4"	14-18	11-13
3/8"	33-42	25-31
1/2"	50-62	37-45
5/8"	63-77	47-56
3/4"	90-110	67-81
Do not over tighten		

## 14. Press Tool and Jaw Compatibility

### 14.1 Press tool and jaw compatibility - 24 kN

Table 10

24 kN Machines and Jaws				
Manufacturer	Tool	Jaw Manufacturer		
		Milwaukee	ROTHENBERGER	REMS
		Size 1/4" to 1 1/8"	Size 1/4" to 1 1/8"	Size 1/4" to 1 1/8"
Milwaukee	M12	✓	✓	
REMS	Mini Press			✓
RIDGID	RP200	✓	✓	
	RP210	✓	✓	
	RP240	✓	✓	
	RP241	✓	✓	
ROTHENBERGER	Romax TT	✓	✓	
Viega	Picco	✓	✓	
	Picco 6	✓	✓	

### 14.2 Press tool and jaw compatibility - 32 kN

Table 11

32 kN Machines and Jaws				
Manufacturer	Tool	Jaw Manufacturer		
		Milwaukee	ROTHENBERGER	REMS
		Size 1/4" to 1 3/8"	Size 1/4" to 1 3/8"	Size 1/4" to 1 1/8"
DeWalt	DCE200	✓	✓	✓
Klauke	UAP332	✓	✓	✓
	UAP432	✓	✓	✓
Milwaukee	M18	✓	✓	✓
	M18 Long Throw	✓	✓	✓
NIBCO	PC-100	✓	✓	✓
	PC-280	✓	✓	✓
Novopress	ACO202	✓	✓	✓
	ACO202 XL	✓	✓	✓
	ACO203	✓	✓	✓
	ACO203XL	✓	✓	✓
REMS	PowerPress			✓
	Akku-Press			✓
RIDGID	RP330	✓	✓	✓
	RP340	✓	✓	✓
	RP350	✓	✓	✓
	RP351	✓	✓	✓
ROTHENBERGER	Romax 3000	✓	✓	✓
	Romax 4000	✓	✓	✓
Viega	Pressgun 5	✓	✓	✓
	Pressgun 6	✓	✓	✓
VIRAX	Viper P25+	✓	✓	✓
	Viper P30+	✓	✓	✓

Note: For latest information on press tool and jaw compatibility information for >B< MaxiPro please visit: <https://conexbanninger.com/en-us/>.



## 15. >B< MaxiPro Product Range

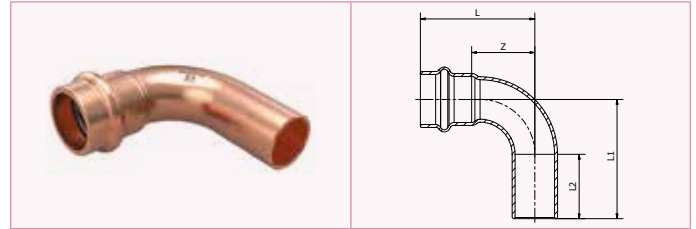

### MPA5001 90° Street Bend

Code	Size	L Inch	L mm	L1 Inch	L1 mm	L2 Inch	L2 mm	Z Inch	Z mm
MPA5001 0030001	3/8"	1.30	33	1.36	34.5	0.83	21.0	0.59	15
MPA5001 0040001	1/2"	1.24	31.5	1.36	34.5	0.81	20.5	0.55	14
MPA5001 0050001	5/8"	1.54	39	1.77	45	0.94	24.0	0.71	18
MPA5001 0060001	3/4"	1.67	42.5	1.89	48	0.98	25.0	0.81	20.5
MPA5001 0070001	7/8"	1.97	50	2.09	53	1.06	27.0	1.02	26
MPA5001 0080001	1"	2.13	54	2.20	56	1.04	26.5	1.22	33
MPA5001 0090001	1 1/8"	2.24	57	2.42	61.5	1.12	28.5	1.24	31.5
MPA5001 0110001	1 3/8"	2.72	69	3.22	82	1.46	37.0	1.38	35

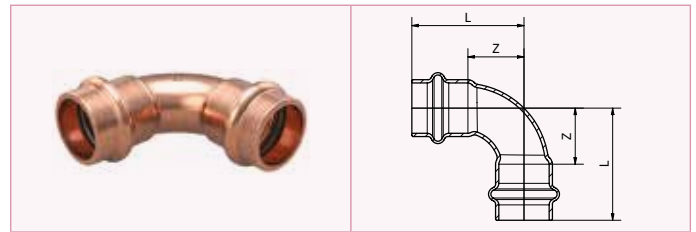

### MPA5002 90° Bend

Code	Size	L Inch	L mm	Z Inch	Z mm
MPA5002 0020001	1/4"	1.28	32.5	0.57	14.5
MPA5002 0030001	3/8"	1.30	33	0.59	15
MPA5002 0040001	1/2"	1.24	31.5	0.55	14
MPA5002 0050001	5/8"	1.54	39	0.71	18
MPA5002 0060001	3/4"	1.67	42.5	0.81	20.5
MPA5002 0070001	7/8"	1.97	50	1.02	26
MPA5002 0080001	1"	2.09	53	1.16	29.5
MPA5002 0090001	1 1/8"	2.24	57	1.24	31.5
MPA5002 0110001	1 3/8"	2.72	69	1.38	35

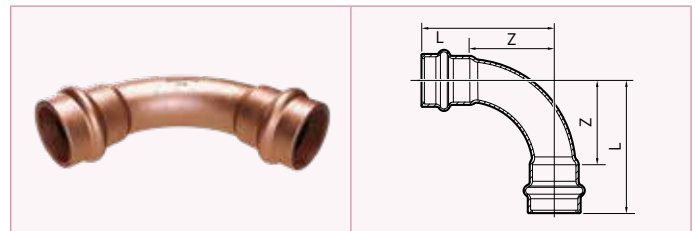

### MPA5002L 90° Bend

Code	Size	L Inch	L mm	Z Inch	Z mm
MPA5002L0040001	1/2"	1.71	43.5	1.02	26
MPA5002L0050001	5/8"	1.97	50	1.14	29
MPA5002L0060001	3/4"	2.20	56	1.34	34
MPA5002L0070001	7/8"	3.00	66	1.65	42
MPA5002L0080001	1"	2.87	73	1.95	49.5
MPA5002L0090001	1 1/8"	3.03	77	2.03	51.5
MPA5002L0110001	1 3/8"	3.5	89	2.15	54.7

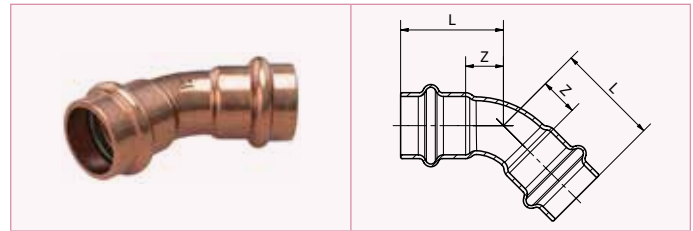

## MPA5041 45° Obtuse Elbow

Code	Size	L Inch	L mm	Z Inch	Z mm
MPA5041 0020001	1/4"	0.93	23.5	0.22	5.5
MPA5041 0030001	3/8"	1.02	26	0.31	8
MPA5041 0040001	1/2"	0.94	24	0.26	6.5
MPA5041 0050001	5/8"	1.10	28	0.28	7
MPA5041 0060001	3/4"	1.24	31.5	0.37	9.5
MPA5041 0070001	7/8"	1.34	34	0.39	10
MPA5041 0080001	1"	1.40	35.5	0.47	12
MPA5041 0090001	1 1/8"	1.56	39.5	0.55	14
MPA5041 0110001	1 3/8"	2.02	52	0.71	18

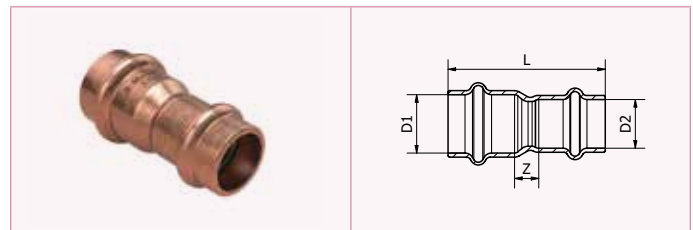

## MPA5240 Reducing Coupler

Code	Size	L Inch	L mm	Z Inch	Z mm	D1	D2
MPA5240 0030201	3/8" x 1/4"	1.65	42	0.24	6	3/8"	1/4"
MPA5240 0040201	1/2" x 1/4"	1.73	44	0.33	8.5	1/2"	1/4"
MPA5240 0040301	1/2" x 3/8"	1.67	42.5	0.28	7	1/2"	3/8"
MPA5240 0050201	5/8" x 1/4"	2.05	52	0.51	13	5/8"	1/4"
MPA5240 0050301	5/8" x 3/8"	1.87	47.5	0.33	8.5	5/8"	3/8"
MPA5240 0050401	5/8" x 1/2"	1.79	45.5	0.28	7	5/8"	1/2"
MPA5240 0060301	3/4" x 3/8"	2.01	51	0.43	11	3/4"	3/8"
MPA5240 0060401	3/4" x 1/2"	1.81	46	0.26	6.5	3/4"	1/2"
MPA5240 0060501	3/4" x 5/8"	2.07	52.5	0.37	9.5	3/4"	5/8"
MPA5240 0070401	7/8" x 1/2"	2.07	52.5	0.43	11	7/8"	1/2"
MPA5240 0070501	7/8" x 5/8"	2.07	52.5	0.30	7.5	7/8"	5/8"
MPA5240 0070601	7/8" x 3/4"	2.07	52.5	0.26	6.5	7/8"	3/4"
MPA5240 0080601	1" x 3/4"	2.17	55	0.37	9.5	1"	3/4"
MPA5240 0090501	1 1/8" x 5/8"	2.17	55	0.33	8.5	1 1/8"	5/8"
MPA5240 0090601	1 1/8" x 3/4"	2.26	57.5	0.39	10	1 1/8"	3/4"
MPA5240 0090701	1 1/8" x 7/8"	2.28	58	0.33	8.5	1 1/8"	7/8"
MPA5240 0090801	1 1/8" x 1"	2.20	56	0.28	7	1 1/8"	1"
MPA5240 0110701	1 3/8" x 7/8"	2.63	67.0	0.51	13.0	1 3/8"	7/8"
MPA5240 0110801	1 3/8" x 1"	2.83	72.0	0.59	15.0	1 3/8"	1"
MPA5240 0110901	1 3/8" x 1 1/8"	2.83	72.0	0.49	12.5	1 3/8"	1 1/8"

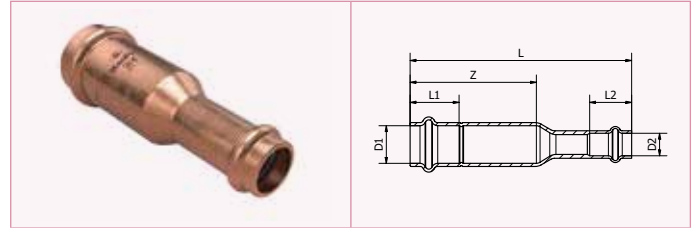

## MPA5240L Long Reducing Coupler

Code	Size	D1 inch	D2 inch	L inch	L mm	L1 inch	L1 mm	L2 inch	L2 mm	Z inch	Z mm
MPA5240L0030201	3/8" x 1/4"	3/8"	1/4"	3.72	94.5	0.71	18	0.71	18	2.28	58
MPA5240L0050301	5/8" x 3/8"	5/8"	3/8"	3.74	95	0.83	21	0.71	18	2.19	55.5
MPA5240L0050401	5/8" x 1/2"	5/8"	1/2"	3.74	95	0.83	21	0.69	17.5	2.19	55.5

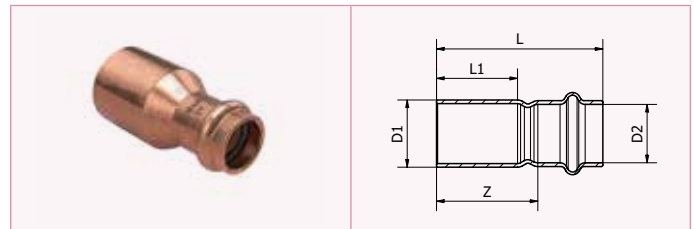

## MPA5243 Fitting Reducer

Code	Size	L Inch	L mm	L1 Inch	L1 mm	Z Inch	Z mm	D1	D2
MPA5243 0030201	3/8" x 1/4"	1.73	44	0.83	21	1.02	26	3/8"	1/4"
MPA5243 0040301	1/2" x 3/8"	1.77	45	0.81	20.5	1.06	27	1/2"	3/8"
MPA5243 0050301	5/8" x 3/8"	1.87	47.5	0.94	24	1.16	29.5	5/8"	3/8"
MPA5243 0050401	5/8" x 1/2"	1.81	46	0.94	24	1.12	28.5	5/8"	1/2"
MPA5243 0060401	3/4" x 1/2"	2.09	53	0.98	25	1.40	35.5	3/4"	1/2"
MPA5243 0060501	3/4" x 5/8"	2.11	53.5	0.98	25	1.28	32.5	3/4"	5/8"
MPA5243 0070401	7/8" x 1/2"	2.13	54	1.06	27	1.44	36.5	7/8"	1/2"
MPA5243 0070501	7/8" x 5/8"	2.15	54.5	1.06	27	1.32	33.5	7/8"	5/8"
MPA5243 0070601	7/8" x 3/4"	2.09	53	1.06	27	1.22	31	7/8"	3/4"
MPA5243 0090401	1 1/8" x 1/2"	2.40	61	1.12	28.5	1.71	43.5	1 1/8"	1/2"
MPA5243 0090501	1 1/8" x 5/8"	2.50	63.5	1.12	28.5	1.67	42.5	1 1/8"	5/8"
MPA5243 0090601	1 1/8" x 3/4"	2.36	60	1.12	28.5	1.50	38	1 1/8"	3/4"
MPA5243 0090701	1 1/8" x 7/8"	2.34	59.5	1.12	28.5	1.40	35.5	1 1/8"	7/8"
MPA5243 0110701	1 3/8" x 7/8"	2.93	74.5	1.48	37.5	1.99	50.5	1 3/8"	7/8"
MPA5243 0110801	1 3/8" x 1"	2.85	72.5	1.48	37.5	1.93	49	1 3/8"	1"
MPA5243 0110901	1 3/8" x 1 1/8"	2.93	74.5	1.48	37.5	1.93	49	1 3/8"	1 1/8"



## MPA5270 Straight Coupler

Code	Size	L Inch	L mm	Z Inch	Z mm
MPA5270 0020001	1/4"	1.54	39	0.12	3
MPA5270 0030001	3/8"	1.5	38	0.12	3
MPA5270 0040001	1/2"	1.57	40	0.2	5
MPA5270 0050001	5/8"	1.77	45	0.12	3
MPA5270 0060001	3/4"	1.79	45.5	0.06	1.5
MPA5270 0070001	7/8"	2.22	56.5	0.33	8.5
MPA5270 0080001	1"	1.93	49	0.08	2
MPA5270 0090001	1 1/8"	2.24	57	0.24	6
MPA5270 0110001	1 3/8"	2.80	71	0.11	3

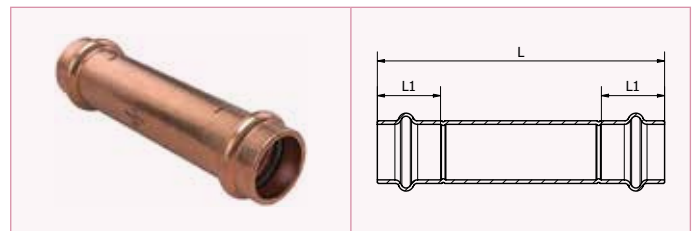

## MPA5270L Long Coupler

Code	Size	L Inch	L mm	Z Inch	Z mm
MPA5270L0020001	1/4"	3.54	90	0.71	18
MPA5270L0030001	3/8"	3.54	90	0.71	18
MPA5270L0040001	1/2"	3.58	91	0.69	17.5
MPA5270L0050001	5/8"	3.98	101	0.83	21
MPA5270L0060001	3/4"	3.98	101	0.86	22
MPA5270L0070001	7/8"	4.17	106	0.95	24
MPA5270L0080001	1"	4.13	105	0.93	23.5
MPA5270L0090001	1 1/8"	4.17	106	1.00	25.5
MPA5270L 0110001	1 3/8"	3.94	100	1.34	34

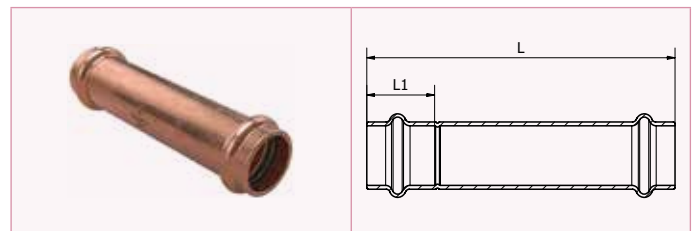

## MPA5275L Long Repair Coupler

Code	Size	L Inch	L mm	Z Inch	Z mm
MPA5275L0020001	1/4"	3.54	90	0.71	18
MPA5275L0030001	3/8"	3.54	90	0.71	18
MPA5275L0040001	1/2"	3.58	91	0.69	17.5
MPA5275L0050001	5/8"	3.98	101	0.83	21
MPA5275L0060001	3/4"	3.98	101	0.86	22
MPA5275L0070001	7/8"	4.17	106	0.95	24
MPA5275L0080001	1"	4.13	105	0.93	23.5
MPA5275L0090001	1 1/8"	4.17	106	1.00	25.5
MPA5275L0110001	1 3/8"	3.94	100	1.34	34

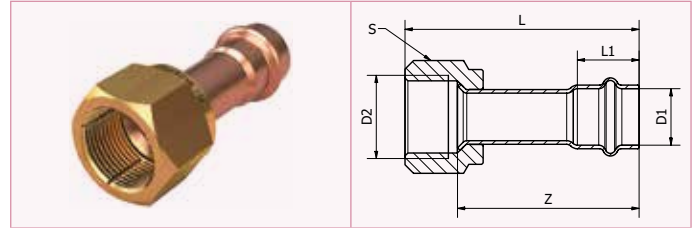

## MPA5285G SAE Copper Formed Flare - Brass Nut

Code	Size	D1 inch	D2 inch	L inch	L mm	L1 inch	L1 mm	Z inch	Z mm	S inch	S mm
MPA5285G0020201	1/4"	1/4"	1/4"	2.13	54	0.71	18	1.81	46	0.67	17
MPA5285G0030301	3/8"	3/8"	3/8"	2.40	61	0.71	18	1.97	50	0.86	22
MPA5285G0040401	1/2"	1/2"	1/2"	2.50	63.5	0.69	17.5	2.03	51.5	0.95	24
MPA5285G0050501	5/8"	5/8"	5/8"	2.91	74	0.83	21	2.28	58	1.06	27
MPA5285G0060601	3/4"	3/4"	3/4"	3.21	81.5	0.86	22	2.50	63.5	1.34	34

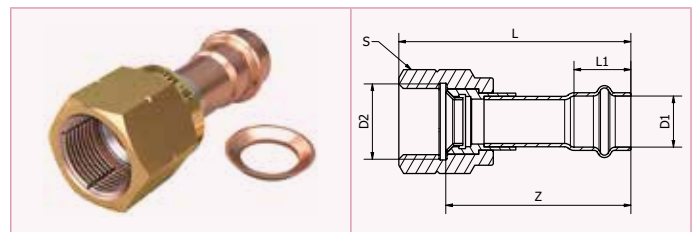

## MPA5286G SAE Stainless Machined Flare - Brass Nut - Copper Washer

Code	Size	D1	D2	L inch	L mm	L1 inch	L1 mm	Z inch	Z mm	S inch	S mm
MPA5286G0020201	1/4"	1/4"	1/4"	2.52	64	0.71	18	2.19	55.5	0.67	17
MPA5286G0030301	3/8"	3/8"	3/8"	2.17	55	0.71	18	1.75	44.5	0.86	22
MPA5286G0040401	1/2"	1/2"	1/2"	2.54	64.5	0.69	17.5	2.07	52.5	0.95	24
MPA5286G0050501	5/8"	5/8"	5/8"	3.11	79	0.83	21	2.48	63	1.06	27
MPA5286G0060601	3/4"	3/4"	3/4"	3.35	85	0.86	22	2.64	67	1.34	34



## MPA5287 Flare Copper Washer

Code	Size	L inch	L mm	A1
MPA5287 0020001	1/4"	0.12	3	45°
MPA5287 0030001	3/8"	0.14	3.5	45°
MPA5287 0040001	1/2"	0.18	4.5	45°
MPA5287 0050001	5/8"	0.18	4.5	45°
MPA5287 0060001	3/4"	0.26	6.5	45°

## MPA5289G SAE Stainless Machined Flare - Stainless Nut - Copper Washer

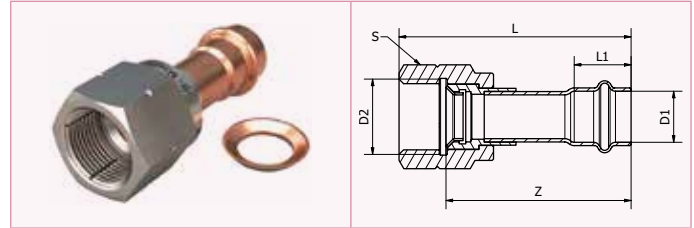

Code	Size	D1	D2	L inch	L mm	L1 inch	L1 mm	Z inch	Z mm	S inch	S mm
MPA5289G0020201	1/4"	1/4"	1/4"	2.52	64	0.71	18	2.19	55.5	0.67	17
MPA5289G0030301	3/8"	3/8"	3/8"	2.17	55	0.71	18	1.75	44.5	0.86	22
MPA5289G0040401	1/2"	1/2"	1/2"	2.54	64.5	0.69	17.5	2.07	52.5	0.95	24
MPA5289G0050501	5/8"	5/8"	5/8"	3.11	79	0.83	21	2.48	63	1.06	27
MPA5289G0060601	3/4"	3/4"	3/4"	3.35	85	0.86	22	2.64	67	1.34	34

## MPA5301 Stop End

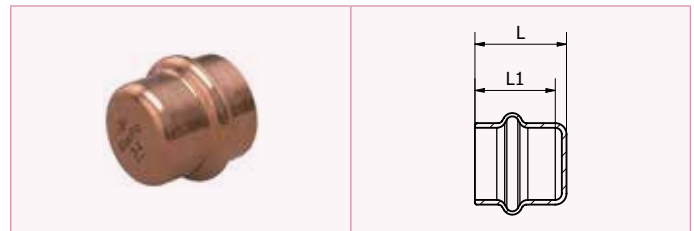

Code	Size	L Inch	L mm	L1 Inch	L1 mm
MPA5301 0020001	1/4"	0.77	19.5	0.71	18
MPA5301 0030001	3/8"	0.77	19.5	0.71	18
MPA5301 0040001	1/2"	0.75	19	0.69	17.5
MPA5301 0050001	5/8"	0.89	22.5	0.83	21
MPA5301 0060001	3/4"	0.93	23.5	0.87	22
MPA5301 0070001	7/8"	1.02	26	0.94	24
MPA5301 0080001	1"	1.00	25.5	0.93	23.5
MPA5301 0090001	1 1/8"	1.08	27.5	1.00	25.5
MPA5301 0110001	1 3/8"	1.47	37.5	1.34	34

## MPA5T Equal Tee

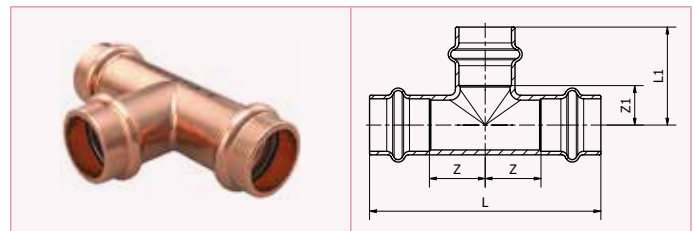

Code	Size	L Inch	L mm	L1 Inch	L1 mm	Z Inch	Z mm	Z1 Inch	Z1 mm
MPA5T 002020201	1/4"	2.13	54	1.06	27	0.35	9	0.35	9
MPA5T 003030301	3/8"	2.48	63	1.22	31	0.53	13.5	0.51	13
MPA5T 004040401	1/2"	2.60	66	1.10	28	0.61	15.5	0.41	10.5
MPA5T 005050501	5/8"	2.99	76	1.26	32	0.67	17	0.43	11
MPA5T 006060601	3/4"	3.31	84	1.42	36	0.79	20	0.55	14
MPA5T 007070701	7/8"	3.50	89	1.52	38.5	0.81	20.5	0.57	14.5
MPA5T 008080801	1"	3.62	92	1.57	40	0.89	22.5	0.65	16.5
MPA5T 009090901	1 1/8"	3.74	95	1.69	43	0.87	22	0.69	17.5
MPA5T 011111101	1 3/8"	4.41	112	2.20	56	0.87	22	0.87	22

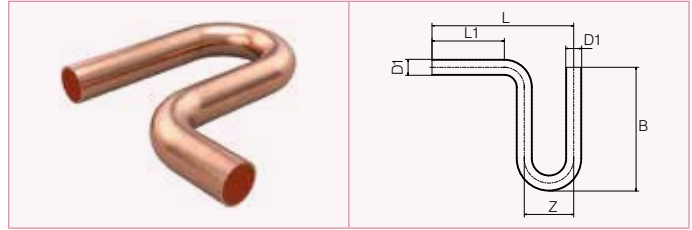

## MPA5698 P-Trap\*

Code	Size	D1 inch	L inch	L mm	L1 inch	L1 mm	B inch	B mm	Z inch	Z mm
MPA5698 0050001	5/8"	5/8"	6.73	171	4.07	103.5	5.96	151.5	1.77	45
MPA5698 0060001	3/4"	3/4"	6.77	172	3.58	91	6.24	158.5	2.12	54
MPA5698 0070001	7/8"	7/8"	6.73	171	2.83	72	6.69	170	2.60	66
MPA5698 0090001	1 1/8"	1 1/8"	6.69	170	1.73	44	6.83	173.5	3.31	84

\*Note: Not UL approved.



## MPA Depth Gauge Depth Gauge 1/4" to 1 3/8" and Marker

Code	Description
MPA Depth Gauge	>B< MaxiPro Depth Gauge 1/4" to 1 3/8" and Marker

## MPABPSOIL Press Fitting Lubricant



Code	Size
MPABPSOIL100ML	100 ml

## 16. Fifteen-Year Limited Warranty

Conex Universal Ltd. warrants that its >B< MaxiPro fittings will be free of material defects resulting from errors in manufacture, for fifteen (15) years from the date of first purchase by an end user. This warranty will be void if not professionally installed by a trained and certified >B< MaxiPro installer\*, and used and maintained in accordance with the installation and maintenance instructions detailed in the >B< MaxiPro technical brochure.

**THERE ARE NO WARRANTIES WHICH EXTEND BEYOND THIS DESCRIPTION, EXCEPT FOR ANY REQUIREMENTS THAT ARE LEGALLY MANDATED IN THE JURISDICTION OF THE FIRST END USER'S PREMISES. THIS WARRANTY IS LIMITED TO THE REPAIR OR REPLACEMENT OF MATERIALLY DEFECTIVE FITTINGS AT THE SOLE DISCRETION OF CONEX UNIVERSAL LTD.**

At the request of Conex Universal Ltd. the claimed defective fitting(s) must be returned to the address below.\*\* Conex Universal Ltd. reserves the right to inspect and test claimed defective fittings before deciding whether to repair or replace a fitting claimed to be defective.

**This Warranty is subject to the following additional conditions:**

- 20
- A. Any claimed defect(s) must be reported to Conex Universal Ltd. within one month of the first occurrence of any such claimed defect, clearly setting out the nature of the claim and the circumstances surrounding it.
- B. Conex Universal Ltd. shall have no liability in respect of any fitting claimed to be defective if any of the following circumstances apply:
- defective installation;
  - normal wear and tear;
  - willful misconduct;
  - negligence or omissions of any party other than Conex Universal Ltd.;
  - abnormal working or environmental conditions;
  - failure to follow the installation and maintenance instructions detailed in the >B< MaxiPro technical brochure, and any other instructions of Conex Universal Ltd. communicated through the Conex Bänninger website or its successor, [www.conexbanninger.com](http://www.conexbanninger.com) (the Website) or otherwise;

- misuse (which includes any use of the fittings for a purpose or in a situation / environment or for an application other than that for which it was designed according to the specifications of the fittings as described on the Website or in other materials provided to the buyer from Conex Universal Ltd.); or
- alteration or repair of any fitting without the prior written approval of Conex Universal Ltd..

C. At the request of Conex Universal Ltd., the person claiming under this warranty must deliver to Conex Universal Ltd. written evidence of the date of first purchase by an end user of the products claimed to be defective.

\*All certified >B< MaxiPro installers must have participated in and passed the requisite Conex Universal Ltd., >B< MaxiPro product course, or have otherwise been approved by Conex Universal Ltd. to use and install the >B< MaxiPro product. In either case, all certified >B< MaxiPro installers must have valid training certificates, which can be made available for proof of certification upon request.

\*\* The address for returns is:

Customer Service

**IBP Group LLC.**

155 Bartram Market Drive, Suite 135,  
#163 Saint Johns, FL 32259.



## 17. Abbreviations

<b>AB oil</b>	Alkyl Benzene oil.
<b>ASHRAE 15 - 2016</b>	Safety Standard for Refrigeration Systems.
<b>ASTM-B280-13</b>	American Standard Specification for Seamless Copper Tube for Air Conditioning and Refrigeration Field Service.
<b>ASTM-B88 Type K or L</b>	Seamless Copper Water Tube.
<b>ASTM B1003</b>	Standard Specification for Seamless Copper Tube for Linesets.
<b>ASME B31.5 - 2016 - 2016</b>	Refrigeration Piping and Heat Transfer Components.
<b>CFT</b>	Constant Force Technology.
<b>CMC 2019</b>	California Mechanical Code 2019
<b>HNBR</b>	Hydrogenated Nitrile Butadiene Rubber.
<b>IMC 2021</b>	International Mechanical Code 2021.
<b>IRC 2021</b>	International Residential Code 2021.
<b>ISO 5149-2:2014</b>	International Standard for Refrigerating systems and heat pumps - Safety and environmental requirements - Part 2: Design, construction, testing, marking and documentation.
<b>ISO 9001</b>	Certified quality management system.
<b>ISO 14903:2017</b>	International Standard for Refrigerating systems and heat pumps - Qualification of tightness of components and joints.
<b>LED</b>	Light Emitting Diode.
<b>PAO oil</b>	Poly-alpha-olefin oil.
<b>POE oil</b>	Polyolester oil.
<b>PVE oil</b>	Polyvinylether oil.
<b>SMS</b>	Short Message Service.
<b>UL 207</b>	Standard for Refrigerant-Containing Components and Accessories, Nonelectrical.
<b>UL 1963 - 79</b>	Standard for Refrigerant Recovery / Recycling Equipment. Section 79 Tests of Gaskets and Seals Used in Refrigerant Systems.
<b>UL 109 - 7</b>	Standard for Tube Fittings for Flammable and Combustible Fluids, Refrigeration Service, and Marine Use. Section 7 Pull test.
<b>UL 109 - 8</b>	Standard for Tube Fittings for Flammable and Combustible Fluids, Refrigeration Service, and Marine Use. Section 8 Vibration test.
<b>UMC 2021</b>	Universal Mechanical Code 2021.
<b>UNS</b>	Unified Numbering System.

## 18. Frequently Asked Questions

**1. How long is the Conex Banninger business heritage?**

Since 1909.

**2. Where are the >B< MaxiPro fittings manufactured?**

The products are manufactured in Europe.

**3. Does >B< MaxiPro work on both hard and soft copper?**

Yes, >B< MaxiPro is a press fitting system for use with hard, half hard or annealed copper tube conforming to ASTM-B280 or ASTM-B88 type K or L. Mechanical joints shall not be used on annealed temper copper tube in sizes larger than 7/8 inch (22.2 mm) OD size per International Mechanical Code IMC and 3/4 inch nominal size per Uniform Mechanical Code (UMC).

\*Please refer to >B< MaxiPro - Tube Compatibility Table, see section 12.11.

**4. Can you use >B< MaxiPro to press to aluminium, steel, or stainless steel?**

No, >B< MaxiPro is specifically designed for copper to copper connections. Connecting to dissimilar metals can cause corrosion issues that could cause a failure.

**5. What is the warranty on >B< MaxiPro fittings?**

The product has a fifteen (15) year limited warranty. Please refer to full warranty terms see section 16.

**6. What material is the O-ring made of?**

The O-ring is manufactured from Hydrogenated Nitrile Butadiene Rubber (HNBR).

**7. What is the expected life of the O-ring in the system?**

The O-ring is manufactured by Germany's leading producer of O-rings. The expected life of the O-ring if used within the product specifications for temperature and pressure is at least 25 years.

**8. Are there any storage issues, including where the fittings are stored in vehicles and exposed to extremes of high or low temperature?**

No, the product is not subject to degradation under normal storage conditions. Provided it is kept in original packaging and not exposed to direct sunlight for long periods. Please see section 10.0 for details regarding fitting storage.

**9. What refrigerants are compatible with >B< MaxiPro?**

>B< MaxiPro is compatible for use with R-125, R-134a, R-404A, R-407A, R-407C, R-407F, R-407H, R-410A, R-417A, R-421A, R-422B, R-422D, R-427A, R-438A, R-448A, R-449A, R-450A, R-452A, R-452C, R-507A, R-513A, R513B, R-515B, R-718, R-424A, R-434A, R-437A, R-453A, R-456A, R-513, Ethylene Glycol and HYCOOL 20.

**Note:** >B< MaxiPro fittings are NOT suitable for R-717, R-723, R-764, R-744, R-22 refrigerants.

Please check our website: <https://conexbanninger.com/en-us/> for updates on the >B< MaxiPro range.

**10. What oils are approved for use with >B< MaxiPro?**

>B< MaxiPro is approved for use with POE, PVE, PAO, AB and MO. The O-ring has been tested successfully with PAG oil however PAG oil should not be used with copper systems due to potential for corrosion of the copper material.

**11. If a fitting leaks on installation, can you braze the fitting rather than cutting out the joint and having to replace missing tube?**

No, if a fitting that has been pressed is leaking, the fitting must be cut out and replaced. You should not attempt to braze the fitting as you may melt the O-ring material and thus introduce contaminants into the system that could cause other system issues.

**12. Is there a concern about ice building up and then thawing under the fitting in a horizontal or vertical configuration?**

No, >B< MaxiPro has been thoroughly freeze / thaw tested. ISO 14903 - Freeze / thaw test, compliant.

**13. Are there any concerns with corrosion where installations are made in coastal areas or with respect to cleaning agents?**

No, >B< MaxiPro has been Acid Salt Spray tested to ASTM G85. As with all copper installations exposure to ammonia should be avoided.

**14. How do you know when a ROTHENBERGER press tool needs to be serviced?**

The tools service counter keeps a record of the number of pressings. The LED flashes after 40,000 pressings indicating service required.

**15. Do >B< MaxiPro Jaws need servicing?**

>B< MaxiPro jaws manufactured by ROTHENBERGER are laser hardened and do not require servicing.

**16. Are the >B< MaxiPro jaws manufactured by ROTHENBERGER compatible with any other commercially available press tool?**

Please see section 14. Press Tool and Jaw Compatibility.

**17. What tube diameter is acceptable if a press joint is going to be made with >B< MaxiPro ?**

>B< MaxiPro is a press fitting system for use with hard, half hard or annealed copper tube conforming to ASTM-B280 ASTM-B88 type K or L. Mechanical joints shall not be used on annealed temper copper tube in sizes larger than 7/8 inch (22.2 mm) OD size per International Mechanical Code IMC and 3/4 inch nominal size per Uniform Mechanical Code (UMC). \*Please refer to >B< MaxiPro - Tube Compatibility Table, see section 12.11.

**18. What standards and codes is >B< MaxiPro compliant with and what approvals does it hold?**

>B< MaxiPro fittings are: UL 207 recognized and listed, refrigerant fitting report reference SA44668, approved use for field and factory installations.

UL 109 - 7 Pull test, compliant.

UL 109 - 8 Vibration test, compliant.

UL 1963 - 79 Tests of Gaskets and Seals Used in Refrigerant Systems, compliant.

ISO 5149-2:2014, Refrigerating systems and heat pumps - Safety and environmental requirements - Part 2: Design, construction, testing, marking and documentation, compliant.

ISO 5149-2 - 5.3.2.2.3 Strength pressure test, compliant.

ISO 14903 - 7.6 Pressure temperature vibration tests (PTV), compliant.

ISO 14903 - 7.8 Freezing test, compliant.

ASTM G85 -11, Standard Practice for Modified Salt Spray (Fog) Testing, compliant.

ASHRAE 15 - 2016 Safety Standard for Refrigeration Systems, compliant.

ASME B31.5 - 2016 Refrigeration Piping and Heat Transfer Components, compliant.

2021, 2015 - 2012, 2009 and 2006 International Mechanical Code (IMC), certified, ICC-ES, PMG-1440.

2021, 2015, 2012, 2009 and 2006 International Residential Code (IRC), certified, ICC-ES, PMG-1440.

2021, 2015, 2012, 2009 and 2006 Uniform Mechanical Code (UMC), certified, ICC-ES, PMG-1440.

2019, 2016, 2013, and 2010 California Mechanical Code (CMC), Certified, ICC-ES, PMG-1440.

### 19. Does the O-ring compensate for imperfections in the tube to make a tight seal?

Yes, the O-ring does compensate for small/minor scratches on the surface of the tube. However imperfections adjacent to the press area such as scratches and tubing that is not round must be avoided.

### 20. The product specifications state that the application temperature limits are -40 °F to 250 °F. What happens if we go beyond that limit?

>B< MaxiPro is suitable for continuous operating at temperatures between -40 and +250 °F. It will also cope with short term excursions up to 284 °F. Operating at temperatures outside this range is not acceptable and may lead to failure.

### 21. How clean are >B< MaxiPro fittings?

>B< MaxiPro fittings comply with the cleanliness standard as required in the following Copper Tube Standards ASTM-B280. Keep the ziplock bag sealed to protect fittings from contamination.

### 22. How do the fittings cope with vibration from the system?

Vibration is a recognized cause of leaks and the system must be designed and installed to comply with all local standards and codes of practice which aim to minimize vibration.

>B< MaxiPro fittings have been extensively tested to ensure the joint will not leak as a result of system vibration and complies with the following standards:

- ISO 14903 temperature, pressure cycling and vibration test
- UL 109-8 vibration
- UL 207 fatigue shock test

### 23. Will the O-ring be damaged if acid develops in the refrigeration system?

Good piping practice, a nitrogen purge during any brazing (not required with >B< MaxiPro mechanical fittings), a deep evacuation, and the proper installation and use of filter driers containing modern and effective molecular sieve desiccants will prevent many system failures. Including the build up of acid within the system.

When selecting which desiccant material is best for an application, water capacity, refrigerant and lubricant compatibility, acid capacity, and physical strength are important characteristics and should be considered.

### 24. When pressed, small size fittings, particularly elbows, may allow a small amount of rotational movement to be induced at the joint. Will this affect the security of the joint?

No, some rotational movement is quite acceptable, the joint will not leak nor will it come apart under the pressure loading and during system operation. Some joint movement is good as it will allow for expansion and contraction in the pipework system.

### 25. Is >B< MaxiPro suitable for medical gas applications?

No, >B< MaxiPro is not suitable for medical gas applications.

### 26. Can you press a fitting more than once?

No, >B< MaxiPro fittings can be pressed only once.

### 27. Is >B< MaxiPro approved for drinking water systems?

No, >B< MaxiPro is not approved for drinking water systems.

### 28. Can >B< MaxiPro be used on heating and hot water systems?

No, >B< MaxiPro is approved for use in air conditioning and refrigeration applications only.

### 29. If my system fails to achieve or hold a vacuum what should I do?

#### Problem Solving Vacuum Evacuation

Vacuum evacuation removes air, moisture, and noncondensable gases prior to system charging.

#### Failure to achieve a vacuum:

- A leak or moisture in the system (see below).
- Vacuum pump not working correctly.
- Vacuum pump does not have sufficient capacity.

#### Failure to hold a vacuum:

- A leak in the system or the connections to the system – find all leaks and repair them.
- An ultrasonic leak detector can help pinpoint leaks on a system under vacuum.
- Moisture or refrigerant still in the system – continue evacuation.

No remedial action e.g. cutting out fittings from the system should be taken until a proper fault finding exercise has been completed.

### 30. I am having a problem achieving a seal on a flared connection what should I do?

If you cannot achieve a seal on a flared connection, place a small drop of Conex Bänninger press fitting lubricant on the sealing face.

# Conex | Bänninger

>B< Press

>B< Press Gas

>B< Press Solar

>B< Press XL

>B< Press Carbon

>B< Press Inox

>B< MaxiPro

>B< ACR

**K65**

<A> Press Inox

>B< Push

>B< Sonic

>B< Oyster

>B< Flex

Triflow Solder Ring

Delcop End Feed

Delbraze

Medical Gas

Valves

Conex Compression

Series 3000

Series 4000

Series 5000

Series 8000

OEM Solutions



IBP Group LLC. 155 Bartram Market Drive, Suite 135, #163 Saint Johns, FL 32259

Tel: 904-217-4970 | Fax: 904-460-2603 | Email: SalesUSA@IBPGroup.com | Website: www.conexbanninger.com

**Global Headquarters:**

Conex Universal Limited. Global House, 95 Vantage Point, The Pensnett Estate, Kingswinford, West Midlands, DY6 7FT, UNITED KINGDOM.

Tel: +44 (0) 121 557 2831 | Fax: +44 (0) 121 557 0185 | Email: salesuk@ibpgroup.com | Website: www.conexbanninger.com

The content of this publication is for general information only. It is the user's responsibility to determine suitability of any product, product data and specifications, for the purpose intended and reference should be made to our Technical Department if clarification is required – [technical@ibpgroup.com](mailto:technical@ibpgroup.com). All products must be installed in accordance with our installation instructions. In the interests of technical development we reserve the right to change specification, design and materials without notice.

Conex Bänninger products are approved by numerous Standards Authorities and Certification Bodies. This is a representation of the full range from Conex Universal Ltd. Patents and trademarks are registered in numerous countries. Details on registered and pending patents protecting our products is available at public patent registers or can be requested from [legal@ibpgroup.com](mailto:legal@ibpgroup.com). All documents, images and technical data are © of Conex Universal Limited. E&OA.

More information online at: <https://conexbanninger.com/en-us/>