

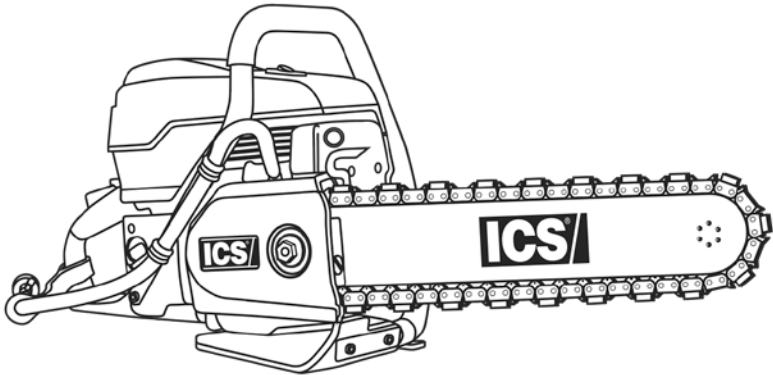

Diamond Tools and Equipment
for Construction and Infrastructure



695XL

OPERATOR MANUAL

WARNING: READ AND UNDERSTAND ALL SAFETY WARNINGS AND ALL INSTRUCTIONS BEFORE YOU USE THIS EQUIPMENT.

Failure to follow the warnings and instructions may result in fire, serious injury, or death.

SAVE ALL WARNINGS AND INSTRUCTIONS FOR FUTURE REFERENCE

This instruction manual contains translations of a manual drafted in English and are provided to assist those who do not speak English as their first language. Being a technical writing, some terms may not have a like or equivalent meaning as translated. Therefore, you should not rely on this translation, and should cross-reference the English version, where relying on the translated instructions could result in harm to your person or property.

TABLE OF CONTENTS

SYMBOLS AND LABELS	4
ICS695XL NAMES AND TERMS	8
PRODUCT IDENTIFICATION	10
INTRODUCTION	11
SAFETY RULES	12
UNPACKING AND ASSEMBLY	16
FUELING	23
OPERATION	26
TRANSPORTING & STORING	36
MAINTENANCE	37
TROUBLESHOOTING	45
EMISSIONS	47
TECHNICAL SPECIFICATIONS	49
SERVICE CENTERS	50

SYMBOLS AND LABELS

THE FOLLOWING SYMBOLS ARE FOUND THROUGHOUT THIS MANUAL AND/OR ON THE SAW AND ARE DESIGNED TO MAKE YOU AWARE OF POTENTIAL HAZARDS OR UNSAFE PRACTICES.



SAFETY ALERT

Indicates that the text that follows explains a danger, warning or caution.



READ INSTRUCTIONS

The original instruction manual contains important safety and operating information. Read and follow the instructions carefully.



WEAR EYE, HEARING AND RESPIRATORY PROTECTION WEAR HEAD PROTECTION

Wear eye, hearing and respiratory protection and a protective helmet when operating the saw.



WEAR LONG PANTS

Wear long pants when operating the saw.



WEAR FOOT PROTECTION

Wear appropriate closed-toe boots when operating the saw.



WEAR HAND PROTECTION

Wear hand protection when operating the saw.



KERF WIDTH

Do not insert tool into slot narrower than chain.



VENTILLATION REQUIRED

Use tool in a well ventilated area

SYMBOLS AND LABELS

THE FOLLOWING SYMBOLS ARE FOUND THROUGHOUT THIS MANUAL AND/OR ON THE SAW AND ARE DESIGNED TO MAKE YOU AWARE OF POTENTIAL HAZARDS OR UNSAFE PRACTICES.



SOUND POWER

Sound power level is 115 dB(A).



BEWARE OF KICKBACK

Kickback can cause severe injuries.



TWO-HANDED HOLD

Operate the saw with two hands, securely gripping both handles



ONE-HANDED HOLD

Do not operate the saw with one hand.



DO NOT USE A LADDER

Never stand on a ladder when using the saw.



FIRE DANGER

Risk of fire if warnings not followed.



SLIPPERY SURFACE

Unsure footing can lead to accidents.

LABELS ON YOUR SAW

SAFETY LABEL

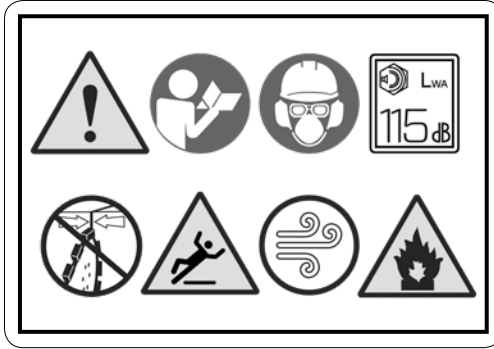

EMISSIONS LABEL



LABEL SHOWN FOR REFERENCE ONLY

NAMEPLATE LABEL

ÅÅÅÅ = Year of Manufacture (ie. 2015)

VV = Week number within the year (ie. 07)

XXXXX = Saw number within production batch in sequential order beginning with 00001

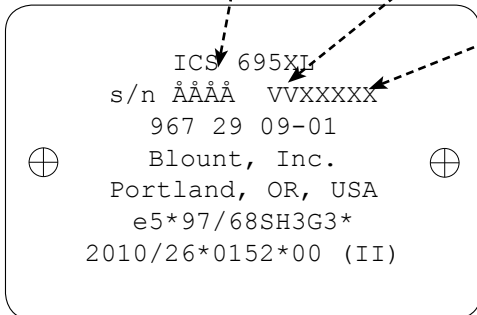

LABELS ON YOUR SAW

OPERATOR CONTROLS

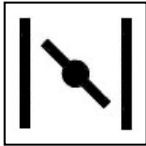

**CHOKE CONTROL
MULTI-FUNCTION LEVER**

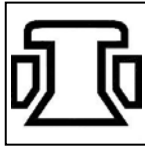

DECOMPRESSION VALVE

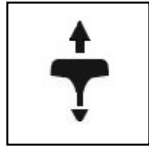

STARTER HANDLE

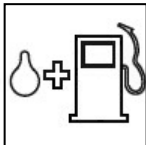

REFUELING

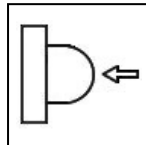

PRIMER/PURGER BULB

ICS695XL NAMES AND TERMS

Air box intake

The only entry point of air into the engine

Bar pad

The mounting pad on the powerhead that helps assure proper alignment of the guidebar.

Bar slot

The slot feature on the guidebar that fits over the alignment block and bar stud.

Bystander safety zone

A 6 m (20 ft) circle around the operator that must remain free from bystanders, children and pets.

Chain catcher

A device for retaining the chain if it breaks or derails.

Chain pitch

The distance between any three consecutive rivets on the chain divided by two.

Chain tensioning screw

An adjustment screw used to set proper tension on the chain and compensate for chain stretch from normal use.

Decompression valve

A device that relieves engine pressure to assist starting.

Front handle

The support handle located at or toward the front of the saw intended to be gripped by the left hand.

Guidebar

A railed structure that supports and guides the chain. Sometimes simply called the "bar".

Kickback

The rapid backward and/or upward motion of the guidebar, occurring when the chain near the top area of the nose of the guidebar contacts a foreign object or snags in the workpiece.

Multi-function lever

A device for setting the choke and temporarily advancing the throttle in a partially open position to aid starting.

Mud flap

A barrier to protect the operator from cutting debris and other projectiles.

ICS695XL NAMES AND TERMS

On/Off or “Stop” control

A control that allows the engine to run or causes the engine to stop.

Powerhead

A saw without the chain or guidebar.

Primer/Purger bulb

A device in the fuel system for supplying extra fuel or for evacuating air to aid starting.

Pushback

The rapid backward motion of the guidebar, occurring when the chain on the top straight portion of the guidebar contacts a foreign object or snags in the workpiece.

Rear handle

The support handle located at or toward the rear of the saw intended to be gripped by the right hand.

Rear hand guard:

A structural barrier at the bottom right side of the rear handle to protect the operator in case the chain breaks or derails.

Side cover:

The component on the powerhead that covers the drive sprocket and directs debris away from the operator during use.

Side cover nut:

The component on the side cover that secures the side cover and guidebar.

Throttle trigger lock-out

A device that prevents the unintentional operation of the throttle trigger until manually released.

Throttle trigger

A mechanism that controls engine RPM.

WallWalker®

A device used as a fulcrum to provide mechanical advantage during cutting.

Water shut-off valve

A mechanism that controls water delivery and flow to the guidebar and chain.

PRODUCT IDENTIFICATION

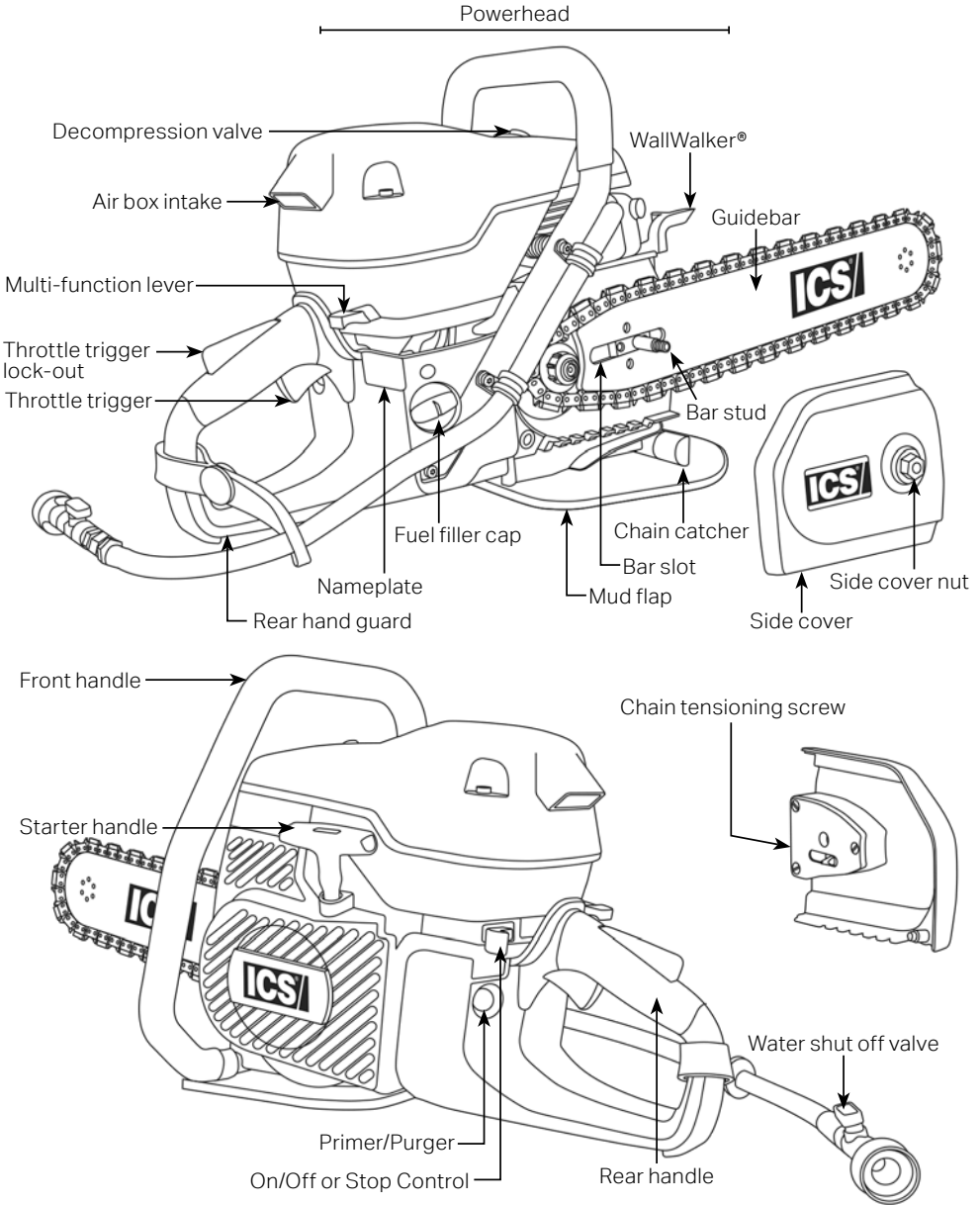

INTRODUCTION

The 695XL saw is designed to cut concrete, stone, and masonry when used with the appropriate genuine ICS Diamond Chain. Ductile iron pipe may also be cut but ONLY if using PowerGrit® Utility Saw Chain. This is a professional tool and is solely intended for use by trained and experienced operators. A first time operator should obtain practical instruction before using the saw, as well as reading and understanding this Operator's Manual.

Local legislation and/or workplace standards may regulate the use of this saw. Determine what regulations are applicable in the place you work before using the saw.

Prop 65 statement:

California Proposition 65 (the Safe Drinking Water and Toxic Enforcement Act of 1986) refers to the California legislation that was intended by its authors to protect California citizens and the State's drinking water sources from chemicals known to cause cancer, birth defects or other reproductive harm, and to inform citizens about exposures to such chemicals. Proposition 65 requires businesses to notify Californians about significant amounts of chemicals in the products they purchase, in their homes or workplaces, or that are released into the environment. By providing this information, Proposition 65 enables Californians to make informed decisions about protecting themselves from exposure to these chemicals. Proposition 65 also prohibits California businesses from knowingly discharging significant amounts of listed chemicals into sources of drinking water.

The engine exhaust from this machine and some types of dust/debris created from its normal operation may contain chemicals known to the State of California to cause cancer, birth defects or other reproductive harm.

SAFETY RULES

To get the maximum benefit from your saw, and assure maximum safety, be sure to read this manual thoroughly and follow the safety instructions provided.

EXPLANATION OF WARNING LEVELS

DANGER

Indicates a hazard with a high level of risk which, if not avoided, will result in death or serious injury.

WARNING

Indicates a hazard with a medium level of risk which, if not avoided, could result in death or serious injury.

CAUTION

Indicates a hazard with a low level of risk which, if not avoided, could result in minor or moderate injury.

IMPORTANT

Indicates a potential situation exists which, if not avoided, may result in damage to your saw or property.

HANDLING FUEL SAFELY

WARNING

Fuel vapors are highly flammable.

Turn off the saw, lock the off/on switch in the “STOP” position, and allow the engine to cool a few minutes before fueling. Do not smoke or refuel the saw in close proximity to any ignition sources. Move the saw at least 3 m (10 ft) from the fueling area before restarting it.

Avoid spilling fuel on yourself or on the saw.

Use only approved containers to transport and store fuel. If fuel is spilled on the saw, wipe up the spillage and allow the rest to evaporate. If fuel is spilled on yourself or your clothes, immediately remove contaminated clothing and wash any part of your body that has contacted fuel with soap and warm water.

CAUTION

Check saw for fuel leaks before starting.

Check regularly for leaks from the fuel caps and fuel lines and do not start saw if any leaks are found.

WORK AREA SAFETY

Following are the basic instructions to assure work area safety.

DANGER

Breathing exhaust gases can cause asphyxiation and carbon monoxide poisoning in high concentrations.

Use the saw only in a well-ventilated area.

WARNING

Drugs or alcohol can impair vision, dexterity, and judgment.

Do not operate the saw when tired or under the influence of any substance.

CAUTION

Remove or control slurry to prevent slippery conditions while cutting.

This saw uses water and can cause slippery surfaces due to the slurry produced and/or freezing temperatures.

Keep children and bystanders away from work area.

Set up a well-marked safety zone with a roped boundary and clear signs to keep bystanders at least 6 m (20 ft) away.

PERSONAL SAFETY

Following are the basic instructions to assure personal safety.

WARNING**Always wear protective clothing.**

At a minimum always wear eye protection and/or face shield, hearing protection, long sleeve shirt, long pants, closed toe shoes with non-slip soles, and gloves. In many work situations, a hard hat and steel toed shoes may also be required. Avoid loose fitting clothing.

Long-term exposure to noise can result in permanent hearing impairment.

Always wear approved hearing protection.

This saw can generate hazardous dust and vapors.

Determine the nature of the material you are going to cut before proceeding with the job. Be especially aware of cutting materials containing silica and asbestos as inhaling dust can result in respiratory disease. Be sure to use appropriate respiratory protection designed to filter out microscopic particles. Be sure to use adequate water pressure.

Over-exposure to vibration can lead to circulatory and/or nerve damage to the extremities, especially in cold temperatures (Reynaud's Disease).

If you experience tingling, numbness, pain or changes in skin color, particularly in your fingers, hands or wrists, stop using the saw immediately. If the problem persists, seek medical attention.

This machine produces an electromagnetic field during operation.

This field may under some circumstances interfere with active or passive medical implants. To reduce the risk of serious or fatal injury, we recommend persons with medical implants consult their physician and the medical implant manufacturer before operating this machine.

USING THE ICS SAW SAFELY

Following are the basic instructions to assure safe use of the saw. Also read and understand additional safety precautions specific to the operation and maintenance of the saw throughout this manual.

DANGER

DO NOT operate the ICS saw with a saw chain or saw bar designed to cut wood.

Using wood cutting saw chain on the ICS saw could result in severe injuries to the operator or a bystander! Use **ONLY** the cutting attachments specified in this manual on this saw.

WARNING

DO NOT operate the saw with damaged, modified, broken, or missing components.

Below safety features are designed to protect against contact with moving parts, ejected debris, broken chain, thrown water, and concrete slurry.

- Side cover
- Mud flap
- Mud flap bracket (Chain Catcher)
- Rear hand guard
- Throttle trigger lock-out

Use only Genuine ICS replacement parts. Use of unauthorized aftermarket parts may result in injury or damage to the saw.

DO NOT insert the guidebar into a slot narrower than the width of the chain.

Rapid pushback, kickback and/or chain breakage could result.

DO NOT operate the saw without an adequate water supply.

The integral water supply channels in the guidebar act to cool and lubricate the cutting system as well as to suppress dust and debris generated during cutting. Assure that the water supply is capable of delivering 1.5 bar (20 psi) pressure to the saw at a minimum flow rate of 4 lpm (1 gpm).

Never attempt to cut ductile iron pipe or similar pipe materials with the saw unless using PowerGrit® Utility Saw Chain.

Using concrete saw chain in these applications can cause the chain to snag abruptly in the cut which may result in chain breakage, pushback and/or kickback.

BOX CONTENTS

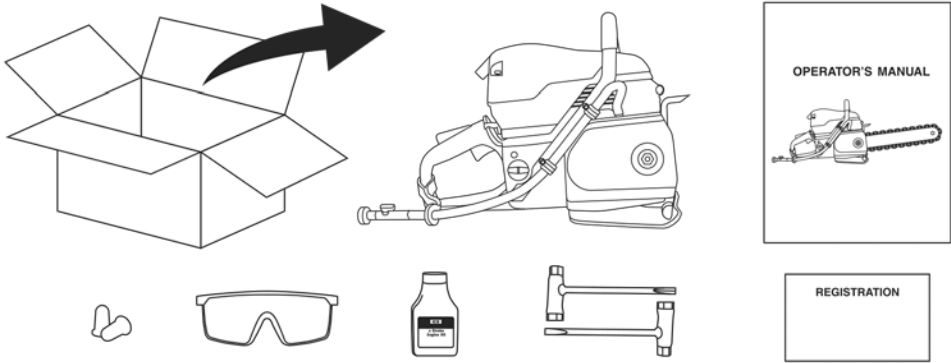

Minimum contents for all packages shown. Some packages also contain guidebar and diamond chain.

See page 44 for listing of compatible guidebars and diamond chain.

GUIDEBAR AND DIAMOND CHAIN INSTALLATION & TENSIONING



Following are the basic instructions for guidebar and diamond chain installation and tensioning.

WARNING

Never perform any maintenance or adjustments on the saw while the engine is running.

Be sure the on/off control is locked in the "STOP" position before proceeding.

Improper chain tension can lead to failure of the chain or derailing of the chain off of the guidebar.

Check tension frequently and adjust if drive links of chain hang 18 mm (3/4 in) or more below the guidebar groove

CAUTION

Always wear gloves when handling the bar and chain.

These components can develop sharp edges and cause cuts.

GUIDEBAR AND DIAMOND CHAIN INSTALLATION & TENSIONING

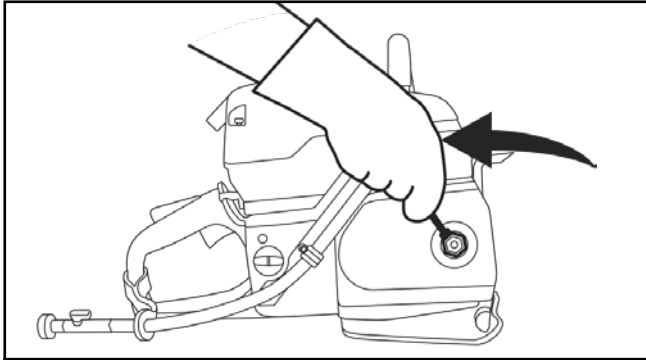

STEP 1

Loosen side cover nut and remove side cover.

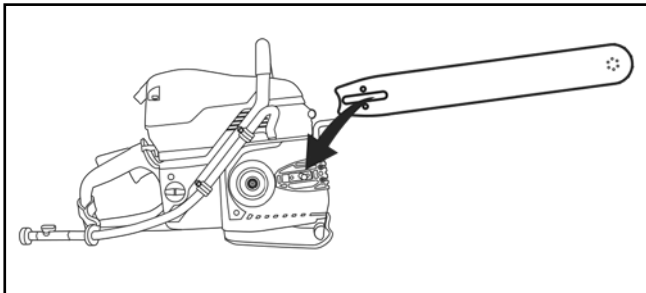

STEP 2

Place guidebar slot over bar stud and alignment block, ensuring even contact with bar pad.

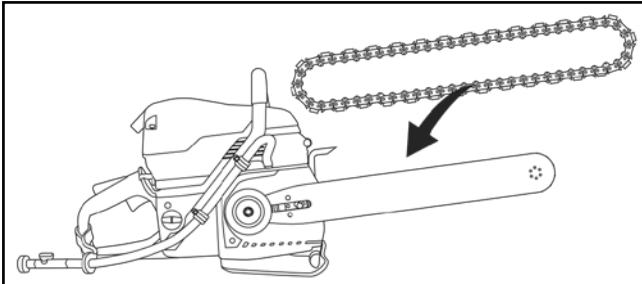
GUIDEBAR AND DIAMOND CHAIN INSTALLATION & TENSIONING**STEP 3**

Mount the diamond chain on the guidebar starting at the drive sprocket and continue over the guidebar nose.

NOTE: FORCE4® requires rim to be pulled outward for chain installation.

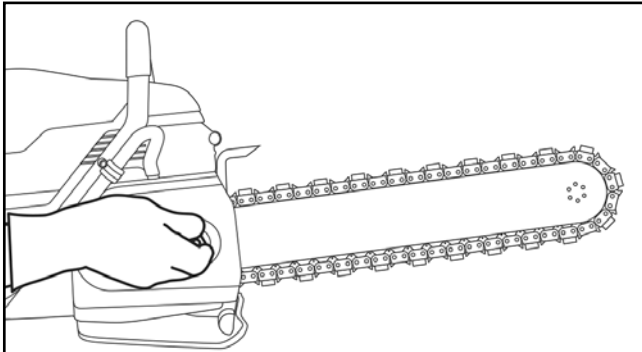
**STEP 4**

Install the side cover and assure tensioning adjustment pin engages in the mating hole in the guidebar. Tighten side cover nut finger tight, but do not fully tighten until chain is properly tensioned.

NOTE: To ease assembly, turn tensioning screw fully counterclockwise before installing side cover.

GUIDEBAR AND DIAMOND CHAIN INSTALLATION & TENSIONING

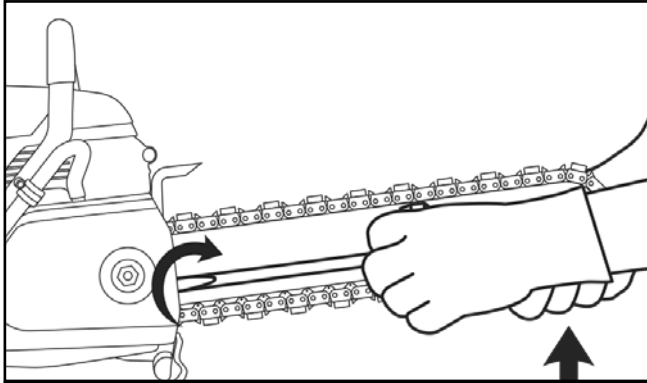
**STEP 5**

Make sure all the drive links are inside the guidebar groove then lift the bar nose and tension the chain by turning the tensioning screw clockwise.

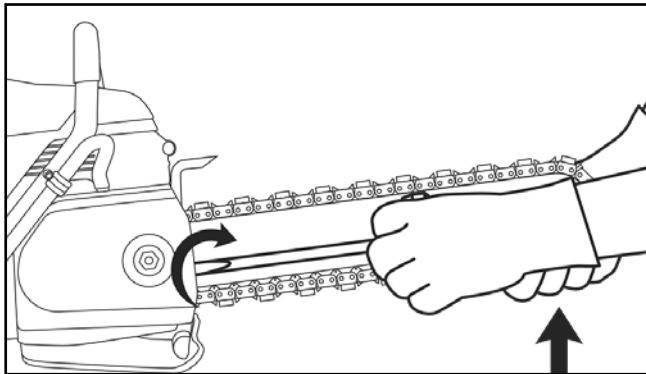
**STEP 6**

Check for proper tension by pulling the chain around the bar by hand. If you cannot easily pull by hand, the chain is too tight and needs to be loosened slightly.
CAUTION: Be aware that the guidebar rails may develop sharp edges over time so always pull the diamond chain by the diamond segments.

GUIDEBAR AND DIAMOND CHAIN INSTALLATION & TENSIONING

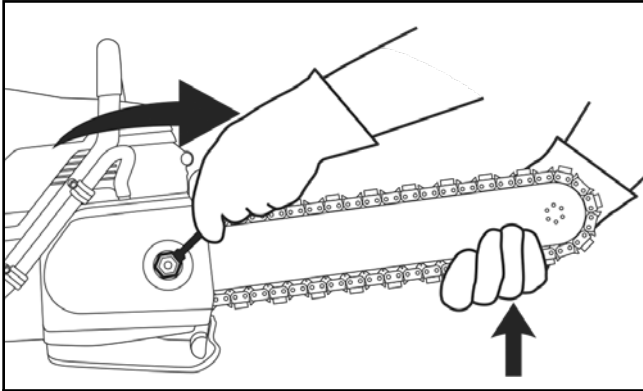

STEP 7

Continue to lift up on the nose of the guidebar and firmly tighten the side cover nut.

NOTE: Tighten the side cover nut to 27-33 Nm (20-25 ft-lbs).

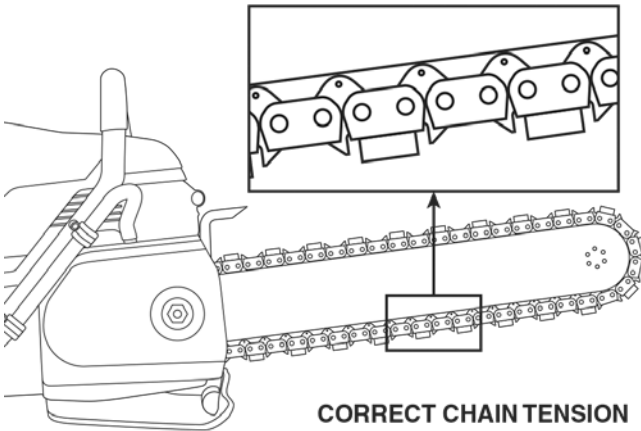

CORRECT CHAIN TENSION



CHAIN TOO TIGHT

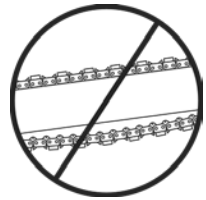

CHAIN TOO LOOSE

STEP 8

Correct chain tension is achieved when drive links of chain hang just outside of the bar groove. Chain should move freely around guidebar by hand.

CHECKING & ADJUSTING CHAIN TENSION



All chains have a tendency to stretch when used. ICS chains stretch more than wood cutting chains because of the abrasive materials they are cutting.

WARNING

Improper chain tension can lead to failure of the chain or derailing of the chain off of the guidebar.

Check chain tension frequently and adjust if drive links of chain hang 18 mm (3/4 in) or more below the guidebar.

CAUTION

Assure that proper chain tension is maintained.

If tension is set too tight, it will lead to excessive chain stretch, and most of the saw's power will be used just to overcome friction. In severe cases the chain may not turn at all, and can lead to chain breakage. If the tension is set too loose, the chain could be thrown off of the bar, or allow the sprocket to turn without turning the chain, which will damage the drive links.

IMPORTANT

When a chain stretches to a point where the drive links are hanging approximately 12 mm (1/2 in) to 18 mm (3/4 in) below the guidebar groove, it is time to tension the chain.

CONNECT TO WATER SUPPLY

Following are the basic instructions to assure correct water supply to the saw.

WARNING

ICS diamond saws require a continuous water supply to the guidebar and chain.

A key purpose of the supply water is dust suppression. The potential for airborne particulates depends on many factors including, but not limited to, the material being cut, application and cutting environment. In all cases, assure that the water supply is capable of delivering 1.5 bar (20 psi) pressure to the saw at a minimum flow rate of 4 lpm (1 gpm).

NOTE: Local and/or regional regulation can vary widely. It is the responsibility of the operator to wear appropriate dust protection applicable in their area and suitable to the application.

Never operate saw with insufficient water supply.

Insufficient water supply will result in excessive wear to the chain, which can lead to excessive stretch, chain breakage and/or damage to the guidebar nose sprocket.

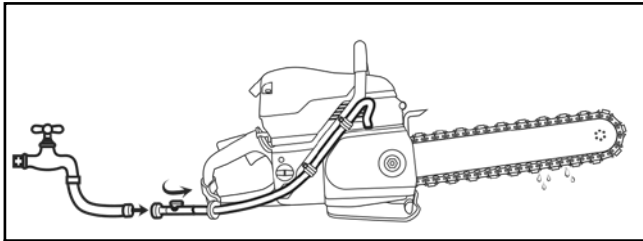

Attach to water supply capable of delivering 1.5 bar (20 psi) pressure to the saw at a minimum flow rate of 4 lpm (1 gpm). The single most important factor an operator can control to increase chain life is to use adequate water pressure.

FUELING

Following are the basic instructions to assure safe fueling procedures.

DANGER

Fuel vapors are highly flammable.

Turn off the saw, lock the off/on switch in the "STOP" position, and allow the engine to cool a few minutes before fueling. Do not smoke or refuel the saw in close proximity to any ignition sources. Move the saw at least 3 m (10 ft) from the fueling area before restarting it.

IMPORTANT

FUEL

ICS saws require the use of high quality, 90 Octane (95 RON) or higher fuel combined with ICS 2-stroke oil (or other high quality 2-stroke oil) specifically formulated for air-cooled power equipment at a mixture of 2% (50:1). Due to the heavy duty cycle ICS saws are subjected to in both concrete and utility pipe cutting applications, oil mixture and fuel quality are critical to the performance and life of the engine.

BLENDED AND ALKYLATE FUELS

Pre-mixed (2% oil mixture) alkylate fuel (i.e. Aspen 2) is an acceptable alternative to conventional fuel.

NOTE: If using Aspen alkylate fuel or similar, carburetor adjustments are not necessary or recommended.

ETHANOL BLENDED FUEL

While ICS recommends using fuel that does not contain ethanol (alcohol), it is understood that 10% Ethanol blended fuel (E10) is becoming more widespread. ICS saws are not designed to operate with fuel containing more than 10% ethanol.

NOTE: The use of Ethanol blended fuel greater than E10 will cause improper operation and will cause major engine failure. This type of fuel related failure is not covered under warranty.

This saw is certified to be in conformance with Section 213 of the Clean Air Act by the US EPA.

Failure to follow instructions on preparing the fuel and oil mixture may result in emissions violations.

FUEL MIXING INSTRUCTIONS



CAUTION

Pressure can build up in the fuel tank and container and possibly cause sudden release of fuel vapors when the tank is opened.

Open the fuel cap slowly and always provide adequate ventilation when handling fuel.

IMPORTANT

It is important to accurately measure the amount of oil to be mixed with petrol to assure that the correct mixture is obtained. When mixing small amounts of fuel, even small inaccuracies can drastically affect the ratio of the mixture.

Always mix petrol and oil in a clean container approved for use with fuel. Keep fuel container closed tightly to prevent moisture from getting into the fuel. Do not mix more than one month's supply of fuel. This helps prevent the separation of the 2-stroke oil from the petrol (varnishing).

Before fueling, clean the area around fuel cap on the saw to prevent dirt from contaminating the fuel. Contamination of the fuel tank can lead to saw malfunction.

Always begin mixing fuel by pouring half the amount of petrol to be prepared into the mixing container. Then add the correct amount of 2-stroke oil for 2% (50:1) mixture and finish by adding petrol to obtain the total quantity of mixed fuel. Shake the fuel container to thoroughly mix the petrol and oil before adding to the saw. The table below shows the correct quantity of two-cycle oil to be used.

FUEL MIXTURE: 2% (50:1) mixture petrol/oil.

PETROL	OIL
US Gallon	US Fl oz
1	2.6
2 1/2	6.4
5	12.8

PETROL	OIL
Liters	ml
1	20
5	100
10	200
20	400

NOTE: If the saw is not used for an extended period of time (3 months) the fuel tank should be emptied and cleaned.

FUELING THE SAW**CAUTION****Do not overfill the fuel tank.**

Should any fuel spill happen, wipe up the spillage and allow the rest to evaporate. If fuel is spilled on yourself or your clothes, immediately remove contaminated clothing and wash any part of your body that has contacted fuel with soap and warm water.

Pressure can build up in the fuel tank and container and possibly cause sudden release of fuel vapors when the tank is opened.

Open the fuel cap slowly and always provide adequate ventilation when handling fuel.

After adding fuel, carefully install the fuel cap and tighten firmly by hand. Tip the saw slightly to one side and check for leaks. Should any fuel leaks be observed, do not start the saw.

Customers are encouraged to remain consistent in the fuel option they choose for ICS saws. Alternating between options, such as going between traditional fuel to Alkylate fuel (Aspen) and back again may have negative impacts on the engine.

OPERATION

Following are the basic instructions to assure safe operation of the saw.



Never start the saw without the bar, chain and side cover properly assembled.

DO NOT operate the saw with loose, missing, damaged or improperly installed or repaired parts.

Check that the components shown below are intact, undamaged, and installed correctly:

- Side cover nut torqued down properly
- Side cover not damaged and discharge port not plugged
- Handles not loose, gripping area is clean and undamaged
- Mud flap is not ripped, torn or missing and fully attached to the saw
- Cylinder cover is properly secured in place
- Muffler not damaged and is adequately secured to cylinder
- Guidebar not bent or otherwise damaged such as rails dished and uneven
- Nose sprocket not excessively worn or broken, and turns freely
- Diamond chain does not have loose rivets, chassis damage, or missing diamond segments
- Chain tensioner mechanism functions properly and pin is not bent or broken
- Drive sprocket not excessively worn and slides easily on adapter
- Check alignment of drive sprocket and guidebar

PRE-OPERATION SAFETY CHECKS

Perform the following safety checks each day to be sure that the safety features designed into the saw are functioning properly. If any items are excessively worn or damaged, replace before use.

- With on/off switch locked in the "STOP" position, without starting saw and with decompression valve depressed, pull starter rope slowly and inspect for fraying, wear and abrasion
- Assure vibration isolators are intact
- With engine running and without depressing throttle trigger lockout, pull throttle trigger and assure continuous chain movement does not occur
- Verify at engine idle speed that the chain does not move

STARTING & STOPPING THE SAW

WARNING

Be sure that no part of the cutting system is contacting a solid object when starting the saw.

When the choke and/or throttle advance is engaged for starting, the chain may move and cause the saw to react if the chain contacts a solid object.

CAUTION

Move the saw at least 3 m (10 ft) from the fueling area before starting it.

Assure that secure footing is established and chain is not contacting any objects.

When starting the saw, place the saw on clear and level ground.

IMPORTANT

Failure to break-in an engine may result in piston seizure.

It is very important to break-in a new engine to "seat" all moving parts, especially the piston rings. To break-in the engine, run one full tank of 2% (50:1) fuel at idle, cycling the throttle every 5 to 10 minutes to prevent loading.

Do not obstruct air intake.

Loose clothing can inadvertently be drawn into air intake and obstruct air flow which may result in engine stall.

STOPPING THE SAW

To turn the engine off, push the on/off control briefly to the right until engine stops. Once released, control will automatically return to the "START" position. If control is pushed beyond the detent, it will lock in the "STOP" position and prevent starting. Close water valve completely.

COLD ENGINE STARTING PROCEDURE

1. Assure on/off control is not locked in the "STOP" position.
2. Pull the multi-function lever out, which also sets the throttle advance.
3. Depress primer/purger bulb until fuel is visible in bulb. May take 10 or more pushes.
4. Push in decompression valve.
5. Open the water valve 1/4 turn.
6. Place foot on the base of the rear handle, and place one hand on front handle.
7. With opposite hand, slowly pull starter handle until you feel the starter pawls engage.
8. Pull the starter cord (hard, fast, short pulls) **until engine initially fires or "pops"**. Could be as many as 10-15 pulls.
9. Push the multi-function lever in, this will keep throttle in advance position.
10. Pull the starter cord until engine starts - should be 1 to 2 pulls.
11. Release the throttle advance by pulling and releasing the throttle trigger, which allows engine to return to normal idle speed.
12. Allow the engine to idle briefly then pull throttle trigger several times to help warm up the engine.
13. Open the water valve completely.

WARM ENGINE STARTING PROCEDURE

1. Assure on/off control is not locked in the "STOP" position.
2. Pull multi-function lever out, and immediately push back in to set the throttle advance. If the multi-function lever is left in the out position on a warm engine, the carburetor will flood with petrol. If this occurs, see Troubleshooting section.
3. Push in decompression valve.
4. Open the water valve 1/4 turn.
5. Place foot on the base of the rear handle, and place one hand on front handle.
6. With opposite hand, slowly pull starter handle until you feel the starter pawls engage.
7. Pull the starter cord until engine starts. Should be 1-2 pulls.
8. Release the throttle advance by pulling and releasing the throttle trigger, which allows engine to return to normal idle speed.
9. Allow the engine to idle briefly then pull throttle trigger several times to help warm up the engine.
10. Open the water valve completely.

PRECUT CHECKLIST

**WARNING**

Sudden contact of the guidebar nose with a foreign object may generate kickback.

Remove and/or avoid any obstructions (plumbing, water supply hoses, electrical conduit, air ducts, etc.) that may interfere with the cut.

To avoid electrocution, check for live electrical wires.

Wires may be hidden within or behind walls and/or laying around the workspace. Assure that any ancillary electrical equipment (fans, pumps, vacuums, etc.) are properly grounded and certified for use in the intended environment.

Always operate the saw with solid footing and both hands on the saw.

Keep your left hand on the front handle and your right hand on the rear handle. Wrap your thumbs around the handles to assure you maintain a secure grip on both handles.

Never operate the saw during severe inclement weather.

Freezing conditions, lightening and sudden downpours can create hazardous job site conditions.

Always wear protective clothing.

At a minimum always wear eye protection and/or face shield, hearing protection, long sleeve shirt, long pants, closed toe shoes with non-slip soles, and gloves. In many work situations, a hard hat, steel toed shoes and a respirator may also be required. Avoid loose fitting clothing.

Cutting with the saw may generate sparks, especially when cutting through metal (such as rebar), and may start a fire in combustible materials such as dry grass, wood and fuel.

Be sure to use adequate water pressure and have fire fighting equipment readily available.

CUTTING WITH THE SAW**! WARNING**

DO NOT insert the guidebar into a slot narrower than the width of the chain. Rapid pushback, kickback and/or chain breakage could result.

Be sure cut concrete cannot fall and injure the operator or bystanders.

Assure cut piece is controlled and does not fall unexpectedly.

NOTE: Concrete is very heavy; one cubic foot = 30 cm x 30 cm x 30 cm = 68 kg (12 in x 12 in x 12 in = 150 lbs).

! CAUTION

Slippery or unstable surfaces such as ladders may cause a loss of balance or control of the saw.

Always keep proper footing and operate the saw only when standing on fixed, secure and level surface.

Unexpected loss of control of the saw and loss of balance can result in injury.

Do not overreach and do not cut above shoulder height.

Do not allow workpiece to pinch the guidebar and chain, or rapid pushback could result.

Always cut bottom of opening first and assure workpiece is secure and does not shift during cutting operations.

Do not operate saw upside down.

Cutting debris can be directed back towards the operator.

Take special precautions when cutting in horizontal orientation.

Be aware that debris may be ejected differently than when cutting in a vertical position.

IMPORTANT

Always operate saw at full throttle.

For best results, always operate the saw at full power.

CUTTING WITH THE SAW

To assure the best performance from your ICS saw, follow all safety precautions and recommended techniques. Additional helpful information can be obtained at icsdiamondtools.com.

CONCRETE/MASONRY CUTTING**Planning the Cut**

1. Select the proper chain type for the material being cut. Refer to the chain selection guide in this manual. See page 44.
2. Outline the cut with a permanent marker for a visual cutting guide.
3. Avoid pinching the guidebar and chain by using shims or other anchoring devices to stabilize the workpiece. Always plan to cut the bottom of an opening first, then top or sides. Save the easiest cut for last (see image at right).
4. Be sure cut concrete cannot fall and injure the operator or bystanders. As the cut is being completed, assure that appropriate bracing is in place to control the cut section of the workpiece. Concrete is very heavy, one cubic foot = 30 cm x 30 cm x 30 cm = 68 kg (12 in x 12 in x 12 in = 150 lbs)

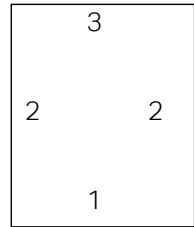

CONCRETE/MASONRY CUTTING

Recommended Concrete Cutting Techniques

1. Plunge in

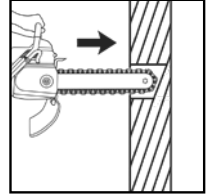

2. Cut down to open slot

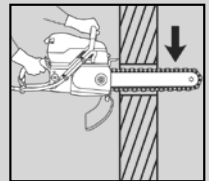

3. Insert WallWalker® rotate rear handle up

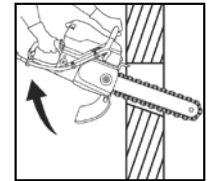

4. Pull saw out, rotate rear handle down, press bottom of saw to leading edge of cut and rotate rear handle up

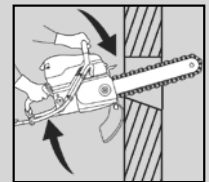

5. Reengage WallWalker® and repeat Steps 3 and 4

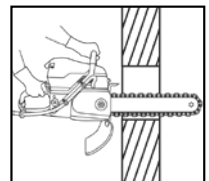

CUTTING TIPS

- For the straightest cuts use the “Step Cut” method:
 - First score the entire cut line approximately a 12 mm (1/2 in) deep using the nose of the guidebar
 - Next, deepen the cut by about two inches
 - Then plunge all the way through and complete the cut using the WallWalker® as a pivot point and pull on the rear handle to rotate the bar into the cut
- Always operate the concrete saw at full throttle. If too much force is applied, the saw will lug or stall. The chain will not have enough speed to cut effectively. If too little feed force is applied, the diamonds will skid and glaze over.
- Plunge cut instead of starting at the top surface of the wall. This will reduce chatter, extend diamond life, create a straighter cut and more quickly enable the use of the WallWalker.
- When cutting heavy rebar, slowly “rock” the saw so that you’re always cutting concrete as well as steel. This will help keep the diamonds exposed. Also, expect less chain life when cutting heavy rebar.
- Expect more chain stretch when making nose-buried cuts for extended periods of time, as the chain does not have a chance to “throw” the slurry away from the nose of the guidebar.
- If the saw begins to cut consistently crooked, stop the saw, remove the bar and chain and turn the bar over and use the other side. Dress worn rails with a belt sander.
Note: The normal life of a guidebar is two to three diamond chains. Heavy rebar can shorten guidebar life.
- The guidebar is solely a guide track for the chain. Never use the guidebar to lift, twist or pry concrete material
- When using a new chain, you can increase the initial cutting speed by “opening up the diamonds”. This can be accomplished by first making a few cuts in an abrasive material such as a cinder block or brick.

PIPE CUTTING USING POWERGRIT® UTILITY SAW CHAIN

To assure the best performance from your ICS® saw when cutting ductile iron pipe or similar pipe materials, follow all safety precautions and recommended cutting techniques.

WARNING

Always assure trench walls are adequately supported before entering work space. Consult applicable regional regulations and obtain necessary approvals before entering a trench or any excavated areas.

Never attempt to cut ductile iron pipe or similar pipe materials with the saw unless using PowerGrit® Utility Saw Chain. Using concrete diamond saw chain in these applications can cause the chain to snag abruptly in the cut which may result in chain breakage, pushback and/or kickback.

Always assure that pipe is properly evacuated before cutting. Pipes may contain sewage, gas or other hazardous materials.

Always support the pipe on both sides of the cut to assure the cut remains open throughout the cutting operation, including when the cut is finished. An improperly supported pipe can cause the cut to close, pinching the chain and guidebar which may result in chain breakage, pushback and/or kickback.

Recommended Pipe Cutting Techniques

1. Make a small plunge cut into the lower quadrant of the pipe to relieve internal pressure and allow contents to drain from pipe in a controlled manner.

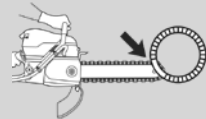

2. With pipe drained, cut from the top of pipe and continue through bottom of the pipe.

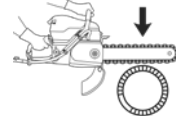

3. To assure straightness of cut, guidebar should extend completely through the pipe during the cut.

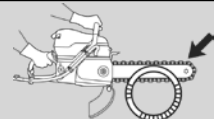

4. To assist with cutting, engage the WallWalker® in the cut when possible to provide additional leverage and alternate cutting between the near and far side walls of the pipe.

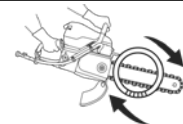

TRANSPORTING & STORING**WARNING****Fuel and vapors are highly flammable**

When transporting or storing fuel, always use a container approved for fuel and assure it is sealed against leaks and/or escaping fumes. Contact with an ignition source could cause fire or explosion.

CAUTION**Always carry the saw by the front handle with the on/off control in the locked "STOP" position and away from your body**

When transporting the saw, assure it is secured to avoid damage and/or personal injury. Proper handling of the saw will reduce the likelihood of accidental contact with the guidebar and chain.

IMPORTANT

ICS recommends mixing fuel in small batches, to be used within 30 days. Fuel stabilizers (additives) can prolong the life of the fuel, but still should not be stored longer than 90 days.

MAINTENANCE AFTER EACH USE

IMPORTANT

1. After cutting, pull trigger to spin the chain for at least 15 seconds with the water on to flush slurry and debris from chain, guidebar and drive sprocket.
2. Stop saw and wash concrete slurry from saw assembly with special attention to the starter housing and flywheel. Do not let slurry dry on saw as it will be very difficult to remove later.
3. Avoid getting any water in the carburetor or exhaust system. If water enters the exhaust port, it can enter the carburetor. To make sure there is no water in the exhaust system, assure the on/off control is locked in the "STOP" position, point the guidebar tip down and pull the starter handle several times to expel water from muffler.
4. Remove the chain and guidebar. Flush out the chain tensioner and side cover with water. Lubricate tensioner with waterproof grease.
5. After cleaning the saw, spray the entire saw body, chain, guidebar, and drive sprocket with lightweight oil. Using lightweight oil on the saw will minimize rust and help reduce slurry build up.
6. Inspect and tighten all fasteners as necessary.
7. Inspect drive sprocket for wear. Replace if tooth tips are pointed, or if groove cuts through top of tooth.
8. Check clutch cup needle bearing for wear. Assure clutch cup spins freely and without excessive play.
9. Check starter cord for wear or damage. Replace as necessary.
10. Inspect air filter. Replace filter if dirty or wet.
11. Spray lightweight oil into the air intake slots on the starter housing and flywheel (this will prevent the starter pawls from sticking).

AFTER EVERY 10 HOURS OF USE

1. Remove the starter cover and clean the flywheel fins and the starter pawls with a wire brush, then apply waterproof grease to the starter pawls.
2. Remove the spark plug and clean with a wire brush. Check the electrode gap. The correct gap is 0.5 mm (0.020 in). Replace if necessary.

AFTER EVERY 40 HOURS OF USE

1. Change the spark plug. Adjust the electrode to 0.5 mm (0.020 in).
2. Check the fuel filter located inside the fuel tank. Clean or replace if clogged.

After each use	After every 10 hours	After every 40 hours
External Cleaning	Clean Starter Housing	Replace Spark Plug
Fasteners/Screws	Check Spark Plug	Check Fuel Filter
Air Intake		
Functional Inspection	Functional Inspection	Functional Inspection
General Inspection	Vibration Isolators	Fuel System
Throttle Trigger Lockout	Muffler	Fuel Filter
On/Off Switch	Carburetor	Air Filter
Mud Flap	Starter Housing	Clutch Cup
Guidebar and Chain	Sprocket	Clutch

AIR FILTER

The polyester air filter must be kept clean for the engine to operate properly. If the saw is not reaching full RPM, most likely the air filter is dirty or wet.

- The air filter should be free of holes and white in color
- Replace the air filter when dirty or wet
- When replacing the air filter, clean the area inside the air box with a clean towel prior to installing new filter
- Inspect air box seals for wear or damage. Replace if damaged

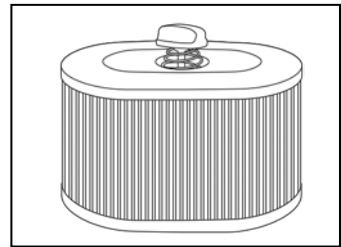

FUEL SYSTEM

- Clean area around fuel cap before removing
- Check the fuel cap and seal for damage
- Check the fuel line for damage
- Check fuel filter, assure it is free of debris
- Replace fuel filter if it is stained dark or clogged (fuel filter cannot be cleaned)

SPARK PLUG

- Clean the spark plug with a wire brush and check to assure the plug gap is 0.5 mm (0.020 in)
- Inspect the spark plug boot, replace if needed
- Inspect lead wire for wear or damage. Replace if necessary (lead wire cannot be replaced separately from ignition module)

IMPORTANT

- Replace spark plug after 40 hours of use, or if the electrode is corroded or eroded
- Always use a recommended spark plug (resistor type) to prevent damage to the piston and cylinder (NGK #BPMR7A or Champion RCJ6Y or equivalent)

CARBURETOR

- The function of the carburetor is to mix fuel with air. Adjustments other than idle speed should only be made by an Authorized Service Center
- Before adjusting the engine idle speed, make sure the air filter is clean, the engine is running, warmed up and the guidebar and chain are assembled on the saw
- Adjust idle screw so that the engine idles smoothly but the clutch does not engage. If the chain begins to spin, turn the idle screw counter-clockwise until the chain stops
- If saw has been running satisfactorily and there is a gradual decrease in power and drop in RPM at full throttle, the filter may have become dirty or wet. (See air filter section)

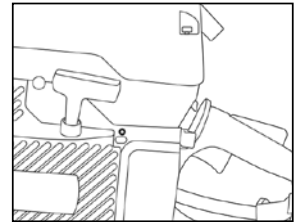

Carburetor idle screw

STARTER RECOIL HOUSING

It is common for concrete slurry to get inside the starter housing assembly during cutting. This can cause starter pawls to stick and not engage when the rope is pulled.

- After each usage, thoroughly flush the starter housing assembly with water
- Spray lightweight oil into the air intake slots on the starter housing and flywheel (this will prevent the starter pawls from sticking)
- Inspect the starter cord for fraying, replace if necessary

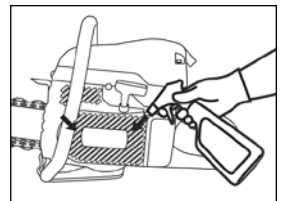

STARTER ROPE REPLACEMENT

- Loosen the four screws that attach the starter cover assembly to the crankcase, and remove the starter cover assembly from the saw
- Pull rope out from pulley approximately 30 cm (12 in) and hook rope into the notch in the pulley. Relax the recoil spring by placing thumb on the pulley and gently allow the pulley to rotate backwards to unwind the spring entirely
- Loosen center screw to remove pulley from starter recoil housing and remove the old starter rope
- Thread new starter rope through hole in the starter recoil housing and then through hole in pulley
- Wrap the starter rope counter clockwise around the raised center of the pulley, looping over top and under the beginning of the wrap. Tighten the knot firmly and assure that free end of rope is as short as possible. Secure the other end of the rope in the starter handle
- Reinstall pulley in starter recoil housing and tighten center screw

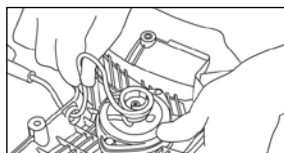
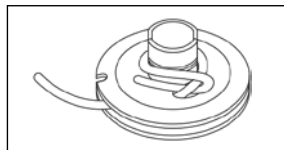

TENSIONING THE RECOIL SPRING

- Hook the rope in the notch of pulley and wind the rope clockwise three times around the raised center of the pulley
- Pull the starter rope with the handle until the rope is unwound, tensioning the spring. Repeat this process, but this time, wind the rope clockwise four times around and then pull the rope with the handle to complete the tensioning of the spring

NOTE: When released, the starter handle should be drawn to the correct start position after tensioning the spring.

IMPORTANT

Check that the pulley can be turned an additional 1/2 turn when the starter cord is pulled all the way out.

STARTER RECOIL HOUSING ASSEMBLY

- To reattach the starter cover assembly, first pull the starter cord out, then hold the starter recoil housing against the crankcase
- Slowly release the starter cord to enable the pulley to fit between the pawls
- Insert and tighten the screws. Use blue Loctite® #242

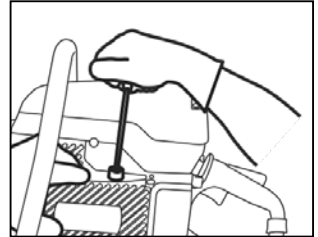

CHAIN TENSIONER

The chain tensioner can become clogged with concrete slurry during cutting.

- After each use thoroughly flush the chain tensioner with water and apply a liberal amount of waterproof grease covering the chain tensioner screw

NOTE: The chain tensioner is located on the side cover.

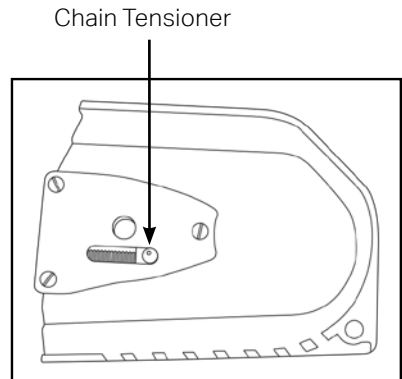
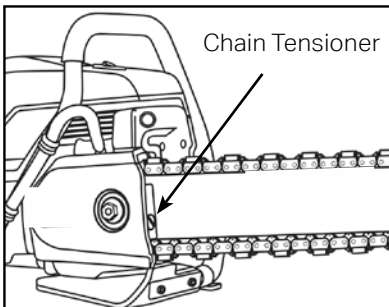

DRIVE SPROCKET

- The drive sprocket (rim sprocket) is a wear item and should be replaced every two to three chains, or when the teeth become pointed or if groove cuts through top of tooth.
- Inspect the sprocket for wear
- The needle bearing inside of the clutch cup is self-lubricating through the crank shaft, spin the clutch cup to assure it spins freely and without excessive play

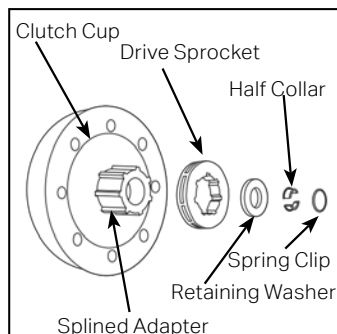

DRIVE SPROCKET REMOVAL/INSTALLATION



CAUTION

Wear safety glasses.

- Remove the side cover, diamond chain and guidebar
 - Using a screwdriver, carefully pry the spring clip from the half collars.
- NOTE: Cup your hand over the end of shaft to prevent spring clip from being ejected.*
- Remove the half collars and retaining washer from the shaft
 - Slide the drive sprocket off of the splined adapter
 - Reengage the clutch cup onto the shaft and slide the drive sprocket onto the splined adapter, either side out
 - Install the retaining washer and half collars onto the shaft
 - Place the spring clip atop the half collars, assuring the half collars are symmetrical with equal gap on either side
 - Engage the spring clip onto the half collars by firmly pressing down with a screwdriver over top of one of the gaps

NOTE: Hold your thumb on the spring clip over the opposite side gap to maintain placement.

- Once the spring clip is partially engaged on one side, perform the same technique to the other side, again pressing firmly over top of the gap
- Visually check proper spring clip engagement in groove of half collars. Both half collars should be firmly secured to the shaft

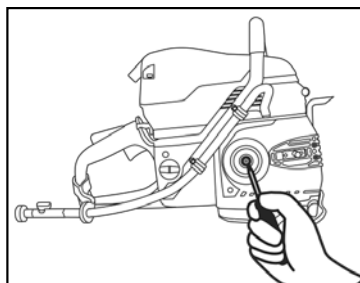

CHAINS & GUIDE BARS



IMPORTANT

Inspect chain segments and drive links for damage or excessive wear. Chains with damage or excessive wear should not be used or repaired, they should be replaced.

NOTE: Guidebars are designed to be used on both sides. If the cut is consistently leading to one side, turn the guidebar over. It is recommended to turn the guidebar over with every new chain.

- A table mounted belt or disc sander can be used to square the rails of a worn guidebar. A badly worn guidebar can quickly damage the chain. If the chain is touching the bottom of the guidebar groove, replace the guidebar
- Check the guidebar for straightness
- Proper chain tension will extend guidebar life
- Under some circumstances, especially low water pressure, the sprocket nose can wear out before the guidebar body. Sprocket nose assemblies may be replaced by an Authorized Service Center
- Periodically clean the water ports inside the groove of the guidebar using a small diameter piece of wire or pipe cleaner
- The guidebar is solely a guide track for the chain. Never use the guidebar to lift, twist or pry concrete material
- Prior to storage, spray the chain and guidebar with lightweight oil

695XL CHAIN SELECTION GUIDE & CONSUMABLES

3/8" Pitch Chain Selection Guide					
Chain & Applications	Soft Stone/ Abrasive/Brick	Natural Stone	Medium Concrete/Light Reinforcement	Hard Concrete/ Heavy Reinforcement	Ductile Iron/Cast Iron/PVC/HDPE
TwinMAX™ <i>General Purpose</i>		♦	♦		
TwinMAX™ Plus <i>For harder materials</i>		♦	♦	♦	
TwinMAX™ Abrasive <i>For brick & block</i>	♦				
3/8" Pitch Consumables					
		30 cm (12 in)	35 cm (14 in)	40 cm (16 in)	
TwinMAX™ Diamond Chain		p/n 71400	p/n 71486	p/n 71607	
TwinMAX™ Plus Diamond Chain		p/n 71704	p/n 71705	p/n 71706	
TwinMAX™ Abrasive Diamond Chain		p/n 71554	p/n 71610	p/n 71611	
3/8" Pitch Guidebar		p/n 553207	p/n 73600	p/n 71600	
3/8" Pitch Drive Sprocket		p/n 70949			

TROUBLESHOOTING

PROBLEM	Possible Cause
SAW WON'T REACH FULL RPM	Dirty air filter
SLOW CHAIN SPEED	Chain tension too tight. Chain should always be able to be pulled around the guidebar by hand. It is normal for the drive links of the chain to hang below the guidebar.
POOR CUTTING SPEED	All of the above, plus diamonds may be glazed over. Make a few cuts in an abrasive material to expose the diamonds.
PREMATURE CHAIN STRETCH	Not enough water pressure. The minimum water pressure required is 1.5 bar (20 psi). Insufficient water supply may result in excessive wear to the chain, which can lead to stretch and chain breakage.
CHAIN TENSIONER BREAKAGE	Side cover nut is not tight enough. Torque to 27-33 Nm (20-25 ft-lbs).
	Tensioning with side cover nut already tight
WATER NOT FLOWING	Water hose is kinked or water supply not turned on
	Water ports plugged with debris
WON'T START	Aged or bad fuel
	Corroded or eroded spark plug
	Stop switch locked in "STOP" position
DIFFICULT TO START	Flooded engine. Push Multi-function lever in, hold throttle on full with foot and pull starter cord (hard, short, fast pulls) until engine starts.
	Fouled spark plug. Remove spark plug, clean, and re-gap to 0.5 mm (0.020 in).
CHAIN BREAKAGE	Improper chain tension
	Insufficient water pressure
	Inserting saw into slot narrower than diamond chain segments
	Using chain that is already stretched beyond ability to tension

THIS PAGE INTENTIONALLY LEFT BLANK

FEDERAL EMISSION CONTROL WARRANTY STATEMENT

YOUR WARRANTY RIGHTS AND OBLIGATIONS

The U.S. Environmental Protection Agency (EPA), Environment Canada and ICS, Blount Inc. are pleased to explain the Emissions Control System Warranty on your 2009 and later small non-road engine. In the U.S. and Canada, new small non-road engines must be designed, built and equipped to meet federal emission regulations.

ICS must warrant the emission control system on your small non-road engine for the period of time listed below provided there has been no abuse, neglect or improper maintenance of your unit.

Your emission control system includes parts such as the carburetor and the ignition system. Also included may be hoses, connectors and other emission related assemblies.

Where a warrantable condition exists, ICS will repair your saw engine at no cost to you. Expenses covered under warranty include diagnosis, parts and labor.

MANUFACTURER'S WARRANTY COVERAGE

The emission control system on 2009 and later small non-road engines is warranted for two years. If any emission related part on your engine (as listed above) is defective, the part will be repaired or replaced by ICS.

FEDERAL EMISSION CONTROL WARRANTY STATEMENT

OWNER'S WARRANTY RESPONSIBILITIES

As the saw owner, you are responsible for the performance of the required maintenance listed in your Operator's Manual. ICS recommends that you retain all receipts covering maintenance on your saw engine, but ICS cannot deny warranty solely for the lack of receipts or for your failure to assure the performance of all scheduled maintenance. However, ICS reserves the right to deny warranty coverage if your saw engine, or a part of it, has failed due to abuse, neglect, improper maintenance, unapproved modifications or the use of parts not made or approved by the original equipment manufacturer.

You are responsible for presenting your saw engine to an ICS authorized servicing dealer as soon as a problem exists. The warranty repairs should be completed in a reasonable amount of time, typically not to exceed 30 days.

If you have any questions regarding your warranty rights and responsibilities, please contact an ICS customer service representative at 1.800.321.1240. www.icsdiamondtools.com

LENGTH OF COVERAGE

ICS warrants to the initial purchaser and each subsequent owner that the engine is free from defects in materials and workmanship which cause the saw engine to fail to conform with applicable emission regulations for a period of two years.

WARRANTY PERIOD

The warranty period begins on the date of sale of the saw engine to the initial purchaser.

TECHNICAL SPECIFICATIONS

Engine Type	2-stroke, Air Cooled
Displacement	94 cc (5.7 cu-in)
Horsepower	4.8 kW (6.4 hp) @ 9000 rpm
Torque	5.7 Nm (50.4 in-lbs) @ 7,200 rpm
Engine Speed	9,300 +/- 150 rpm (max) 2,700 +/- 100 rpm (idle)
Chain Speed at Maximum Power	28 m/s (5500 ft/min)
Weight	9.5 kg (21 lbs) powerhead only
Dimensions	46 cm (18 in) length 36 cm (14 in) height 30 cm (12 in) width
Air Filter	Water resistant polyester
Carburetor	Walbro RWJ-7
Starter	Recoil, dust and water resistant
Ignition	Special water resistant electronic ignition
Clutch	Centrifugal, three shoe, three spring
Fuel ratio	2% (50:1) petrol-to-oil
Fuel Capacity	1 liter (0.26 gallon)
Water Supply Requirement	Minimum 1.5 bar (20 psi)
Water Flow Requirement	Minimum: 4lpm (1 gpm)
Guaranteed Sound Power Level, L_{wa} (1)	115 dB(A); ($K_{wa}=1.0$ dB(A))
Equivalent Sound Pressure at the Operator's Ear L_{pA}	104.6 dB(A) ($K=1.0$ dB(A))
Vibration, $a_{hv,eq}$ Concrete Cutting (2)	3.6 m/s ² ($K=1.0$ m/s ²) Front Handle 3.1 m/s ² ($K=1.0$ m/s ²) Rear Handle
Vibration, $a_{hv,eq}$ Pipe Cutting (2)	5.62 m/s ² ($K=0.2$ m/s ²) Front Handle 5.28 m/s ² ($K=0.2$ m/s ²) Rear Handle
Engine Break-in Period	One tank, without cutting, cycling throttle
Spark Plug	NGK BPMR7A or Champion RCJ6Y Electrode gap 0.5 mm (0.020 in)

(1) Measured in accordance with ANSI S12.51-2012/ISO3741:2010

(2) Measured in accordance with ISO5349-1:2001, ISO22867:2011 and ISO19432:2012

AUTHORIZED SERVICE CENTERS

DEALER	PHONE	ADDRESS	CITY	STATE	ZIP CODE
KENNEDY EQUIPMENT CO INC	714.771.7324	748 N. LEMON ST	ORANGE	CA	92867
ABLE TOOL EQUIPMENT	860.289.2020	410 BURNHAM STREET	SOUTH WINDSOR	CT	06074
EQUIPSERV LLC	770.709.5101	6225 MABELTON PARKWAY SW	MABLETON	GA	30126
STAR EQUIPMENT	515.283.2215	1401 2nd AVE	DES MOINES	IA	50314
MCCANN INDUSTRIES, INC.	630.627.8700	543 SOUTH ROHLWING RD	ADDISON	IL	60101
CLEAN RITE TECH	504.468.7997	1332 FULTON ST	KENNER	LA	70062
ACE CUTTING EQUIPMENT	248.449.4944	25806 NOVI RD.	NOVI	MI	48375
CONCRETE CUTTING & CORING	952.882.0980	12690 CREEK VIEW AVE	SAVAGE	MN	55378
ACME ELECTRIC	218.628.3523	4332 GRAND AVE	DULUTH	MN	55807
MERLIN STELZER SALES CO., INC.	314.535.7540	4109 PAPIN ST	ST. LOUIS	MO	63110
ACME ELECTRIC	701.258.1267	3840 E. ROSSER AVE	BISMARCK	ND	58501
ACME ELECTRIC	701.746.6481	1705 12TH AVE NORTH	GRAND FORKS	ND	58203
ACME ELECTRIC	701.476.4600	920 36TH STREET S.W.	FARGO	ND	58103
ACME ELECTRIC	701.839.2263	700 20TH AVE S.E.	MINOT	ND	58701
ADMAR SUPPLY	585.272.9390	1950 BRIGHTON-HENRIETTA TL RD	ROCHESTER	NY	14623
ADMAR SUPPLY	315.433.5000	6014 DROTT DR	EAST SYRACUSE	NY	13057
ADMAR SUPPLY	518.690.0750	878 ALBANY SHAKER RD	LATHAM	NY	12110
ADMAR SUPPLY	607.754.4700	2305 OLD VESTAL RD	VESTAL	NY	13850
ADMAR SUPPLY	716.873.8000	1394 MILITARY RD	BUFFALO	NY	14217
CESSCO, INC.	503.288.1242	4222 N.E. COLUMBIA BLVD.	PORTLAND	OR	97218
TRI-BORO CONST. SUPPLIES	800.632.9018	435 LOCUST ST	DALLASTOWN	PA	17313
LEHIGH CONSTRUCTION SUPPLY CO.	570.654.3981	295 SCHOOLEY AVE	EXETER	PA	18643
DRIVEKORE, INC.	717.766.7636	101 WESLEY DRIVE	MECHANICSBURG	PA	17055
ECKHART CONSTRUCTION	803.802.6635	1019 SOCIETY LANE	FORT MILL	SC	29707
STAN HOUSTON EQUIPMENT	605.336.3727	501 SOUTH MARION ROAD	SIoux FALLS	SD	57106
STAN HOUSTON EQUIPMENT	605.348.1155	1210 DEADWOOD AVENUE	RAPID CITY	SD	57702
LINCOLN CONTRACTORS SUPPLY	414.541.1327	11111 WEST HAYES AVE	MILWAUKEE	WI	53227
LINCOLN CONTRACTORS SUPPLY	608.249.6476	901 WALSH RD	MADISON	WI	53714
LINCOLN CONTRACTORS SUPPLY	715.359.6111	5207 WESTFAIR AVE	SCHOFIELD	WI	54476
LINCOLN CONTRACTORS SUPPLY	920.757.1901	5663 NUEBERT RD	APPLETON	WI	54913
LINCOLN CONTRACTORS SUPPLY	920.432.8697	1654 MORROW ST	GREEN BAY	WI	54302
LINCOLN CONTRACTORS SUPPLY	715.874.4100	7840 PARTRIDGE AVE	EAU CLAIRE	WI	54703
LEE JENSEN SALES CO, INC	815 459-0929	101 WEST TERRA COTTA	CRYSTAL LAKE	IL	60014
ROCK-CRETE EQUIPMENT LTD.	604 464-1448	50 BURBIDGE STREET	COQUITLAM	BC	V3K 6B1
CONCUT DIAMOND PRODUCTS	561-989-8895	6500 W ROGERS CIRCLE SUITE 6000	BOCA RATON	FL	33487
AUSTECH SUPPLIES PTY LTD	61298541200	UNIT 12, 197 POWER STREET	GLENDENNING	NSW	2761
HATCH BUILDING SUPPLY COMPANY	608 222-0011	5601 MANUFACTURERS DRIVE	MADISON	WI	53704
AMERICAN TOOL AND FASTENER	972-801-9909	1331 E PLANO PKWY STE #B	PLANO	TX	75074
HENARD UTILITY PRODUCTS, INC	501 268-1987	1920 S. MAIN STREET	SEARCY	AR	72143

THIS PAGE INTENTIONALLY LEFT BLANK

ICS | BLOUNT, INC.
4909 SE INTERNATIONAL WAY
PORTLAND, OR 97222
800.321.1240
icsdiamondtools.com