

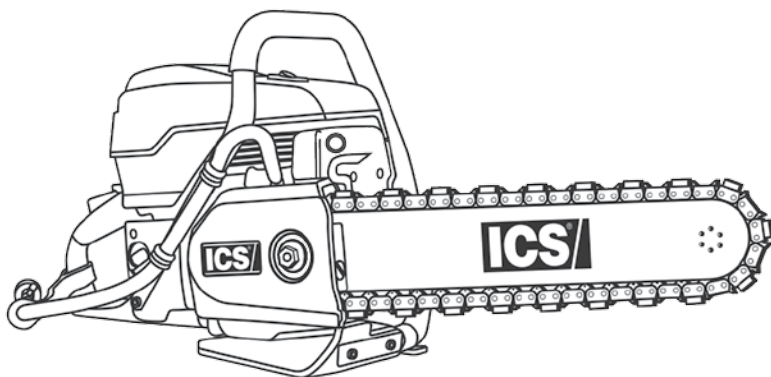

Diamond Tools and Equipment
for Construction and Infrastructure

695XL



SERVICE MANUAL

TABLE OF CONTENTS

SECTION	SECTION TITLE	PAGE NUMBER
	SERVICE MANUAL USE	3
1	TOOLS.....	4
2	POWER CUTTER SPECIFICATIONS.....	5
3	SERIAL NUMBER LOCATION.....	6
4	SPARE PARTS DIAGRAM.....	7
5	AIR INTAKE	18
6	SPARK PLUG	19
7	SIDE COVER & TENSIONER.....	21
8	CLUTCH & RIM SPROCKET	23
9	STARTER SYSTEM.....	28
10	CARBURETOR REMOVAL.....	33
11	MUFFLER.....	37
12	GUIDE BAR STUD	38
13	IGNITION MODULE	39
14	STOP SWITCH.....	40
15	WATER HOSE	42
16	CYLINDER, PISTON & DECOMPRESSION.....	43
17	BOTTOM GUARD/FRONT HANDLE	49
18	REAR HANDLE.....	51
19	FUEL TANK & COMPONENTS.....	55
20	CRANKCASE	63
21	CARBURETOR TUNING.....	76
22	IDLE SPEED ADJUSTMENT ⁸⁰	78
23	DIAGRAMS	79
24	FUEL SYSTEM.....	81
25	CRANKCASE LEAKS	84
26	SPARK PLUG REFERENCE GUIDE	86

Service Manual Use

This manual contains all the technical information necessary for carrying out repairs on the 695XL power cutter. For safe, efficient work, it is of prime importance that the values indicated be adhered to. Routine periodic maintenance is covered in the operator's manual included with each power cutter.

General Service Rules

- Always use the right tools for the job, otherwise components may be damaged.
- Use a plastic dead blow mallet to separate parts attached solidly to each other.
- Mark mating parts as a reassembly reference.
- Keep component parts together as a group. Assemble screws and nuts into appropriate subgroups.
- When reassembling, clean all parts carefully, lubricate moving parts and replace all oil seals, o-rings, gaskets, washers and self-locking nuts.
- **For best results, use only original ICS® replacement parts.**

General Recommendations

- Some procedures in this manual require the use of special tools. These are noted in the service manual.
- Detailed carburetor maintenance and overhaul information is available in Walbro's Diaphragm Carburetor Service Manual. Walbro can be contacted at <http://www.walbro.com> or by calling 1.520.877.3000.



Key #	Part No.	Description
1	71541	Pressure Gauge Bulb
2	71543	Cylinder Assembly Clamps & Piston Stop
3	71565	Electronic Tachometer
4	546191	Workshop Key Torx T27
5	546192	Test Spark Plug
6	546193	Air Gap Gauge
7	546194	Flywheel Puller
8	547277	Piston Stop
9	546196	Wrist Pin Punch
10	546197	Cylinder Seal, Exhaust
11	546198	Cylinder Seal, Inlet Port
12	546289	Puller, Sealing Ring
13	546292	Universal Puller
14	546293	Grip Plate
15	546294	Bearing Puller
16	546295	Bearing Press
17	546307	Screwdriver, Idle
not shown	546659	Clutch Tool
not shown	544120	Flat Blade Srench
not shown	544119	Torque Srench
not shown	70249	14T Bar Nose Sprocket Repair Kit (for 695GC)
not shown	530046	FORCE4™ Bar Nose Sprocket Repair Kit (for 695F4)
not shown	571227	OIL, 2-STROKE 2.6 OZ(6-PACK)
not shown	571228	OIL, 2-STROKE 2.6 OZ (24-PACK)

Engine Type	2-stroke, Air Cooled
Displacement	94 cc (5.7 cu-in)
Horsepower	4.8 kW (6.4 hp) @ 9000 rpm
Torque	5.7 Nm (50.4 in-lbs) @ 7,200 rpm
Engine Speed	9,300 +/- 150 rpm (max) 2,700 +/- 100 rpm (idle)
Chain Speed at Maximum Power	28 m/s (5500 ft/min)
Weight	9.5 kg (21 lbs) powerhead only
Dimensions	46 cm (18 in) length 36 cm (14 in) height 30 cm (12 in) width
Air Filter	Water resistant polyester
Carburetor	Walbro RWJ-7
Starter	Recoil, dust and water resistant
Ignition	Special water resistant electronic ignition
Clutch	Centrifugal, three shoe, three spring
Fuel ratio	2% (50:1) petrol-to-oil
Fuel Capacity	1 liter (0.26 gallon)
Water Supply Requirement	Minimum 1.5 bar (20 psi)
Water Flow Requirement	Minimum: 4lpm (1 gpm)
Guaranteed Sound Power Level, L_{wa} (1)	115 dB(A); (K_{wa} = 1.0 dB(A))
Equivalent Sound Pressure at the Operator's Ear L_{pA}	104.6 dB(A) (K = 1.0 dB(A))
Vibration, $a_{hv,eq}$ Concrete Cutting (2)	3.6 m/s ² (K = 1.0 m/s ²) Front Handle 3.1 m/s ² (K = 1.0 m/s ²) Rear Handle
Vibration, $a_{hv,eq}$ Pipe Cutting (2)	5.62 m/s ² (K = 0.2 m/s ²) Front Handle 5.28 m/s ² (K = 0.2 m/s ²) Rear Handle
Engine Break-in Period	One tank, without cutting, cycling throttle
Spark Plug	NGK BPMR7A or Champion RCJ6Y Electrode gap 0.5 mm (0.020 in)

(1) Measured in accordance with ANSI S12.51-2012/ISO3741:2010

(2) Measured in accordance with ISO5349-1:2001, ISO22867:2011 and ISO19432:2012

3. This section shows the single location of the serial number.

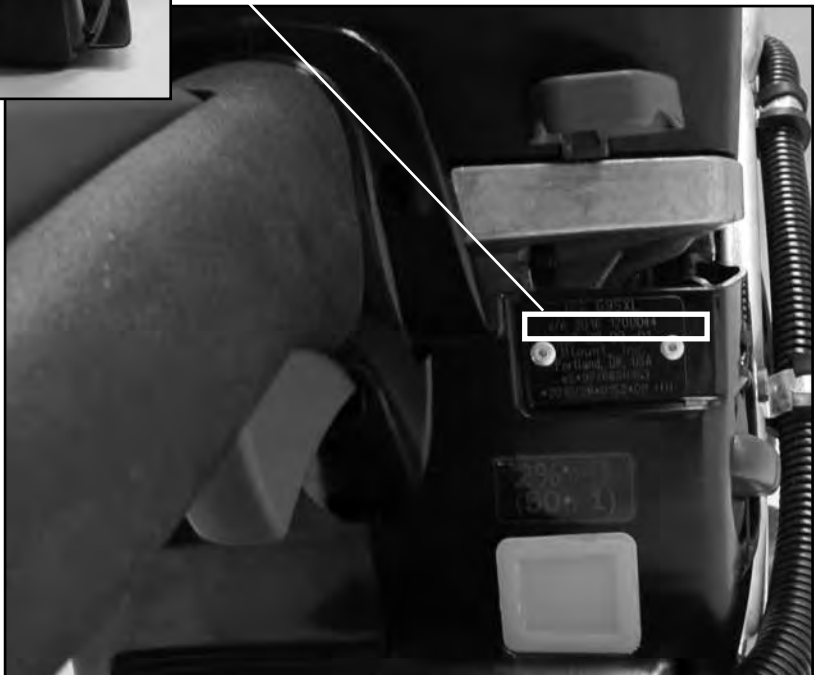

4. This section covers spare parts.

STARTER ASSEMBLY

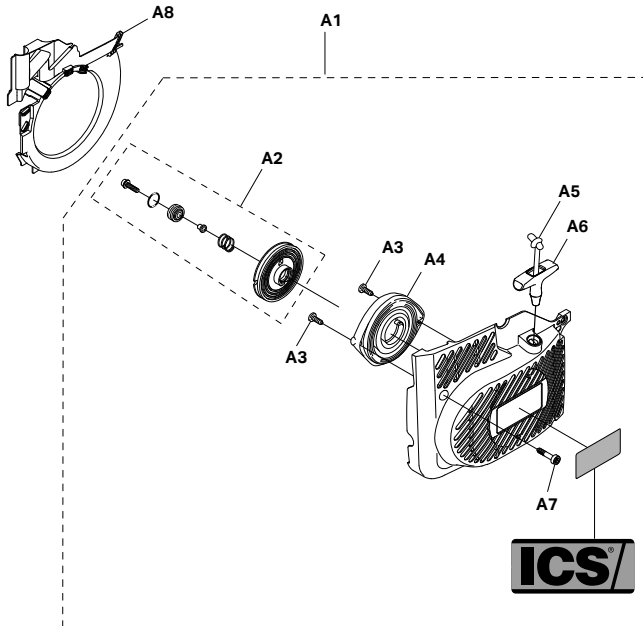

Key #	Part No.	Description
A1	544013	STARTER COVER ASSEMBLY
A2	544127	STARTER PULLEY KIT
A3	543974	SCREW
A4	544021	RECOIL SPRING
A5	544023	STARTER CORD
A6	544024	STARTER HANDLE
A7	544012	SCREW
A8	544026	STARTER COVER SHIELD

FLYWHEEL & IGNITION ASSEMBLY

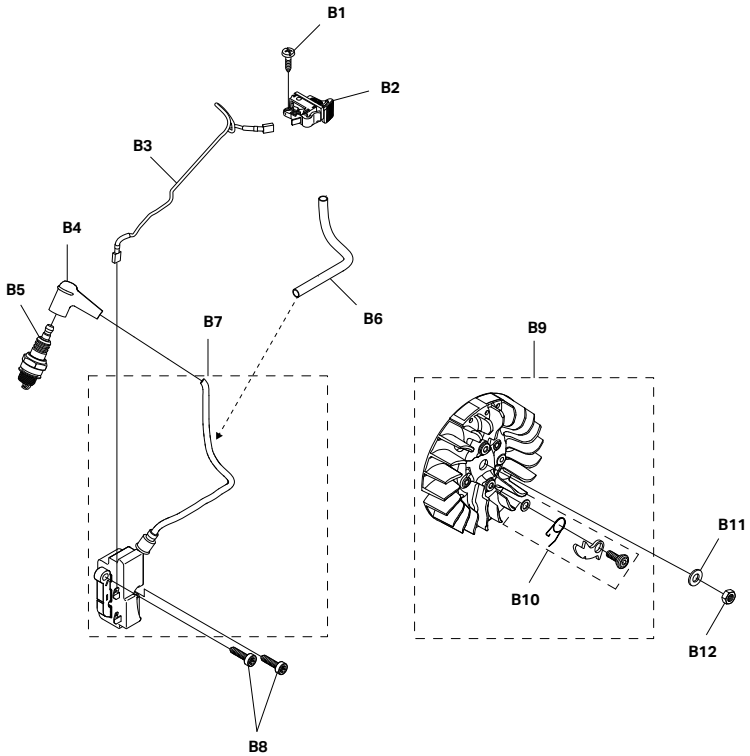

Key #	Part No.	Description
B1	544030	STOP SWITCH SCREW
B2	544031	STOP SWITCH
B3	544032	STOP SWITCH CABLE
B4	544033	SPARK PLUG CAP
B5	544034	SPARK PLUG
B6	544035	PROTECTIVE SLEEVE
B7	544036	IGNITION MODULE
B8	544038	IGNITION MODULE SCREW
B9	544053	FLYWHEEL
B10	544125	STARTER PAWL KIT (INCL. TWO OF EACH ITEM)
B11	544058	STARTER WASHER
B12	544059	STARTER NUT

CLUTCH ASSEMBLY & WALLWALKER®

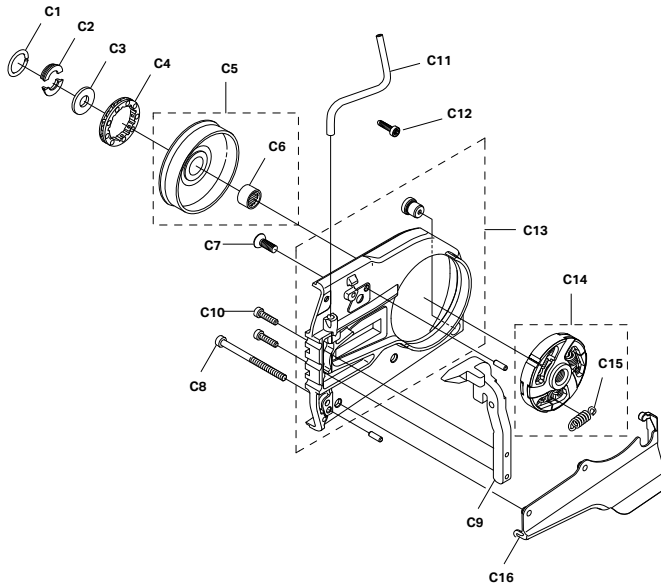

Key #	Part No.	Description
C1	543905	RETAINING RING
C2	551384	SPLIT RETAINER, 695 (PAIR)
C3	543907	SPACER
C4	525496	695F4 FORCE4™ SPROCKET
C4	70949	695GC RIM SPROCKET
C5	543909	CLUTCH CUP
C6	543910	NEEDLE BEARING
C7	543911	BAR BRACKET SCREW
C8	543912	CRANK CASE BOLT
C9	544130	WALLWALKER®
C10	543920	WALLWALKER® SCREW
C11	543915	WATER PIPE
C12	546548	WATER PIPE SCREW
C13	543916	BAR BRACKET
C14	547856	CLUTCH KIT
C15	543928	CLUTCH SPRING
C16	544137	SHIELD

SIDE COVER & TENSIONER ASSEMBLY

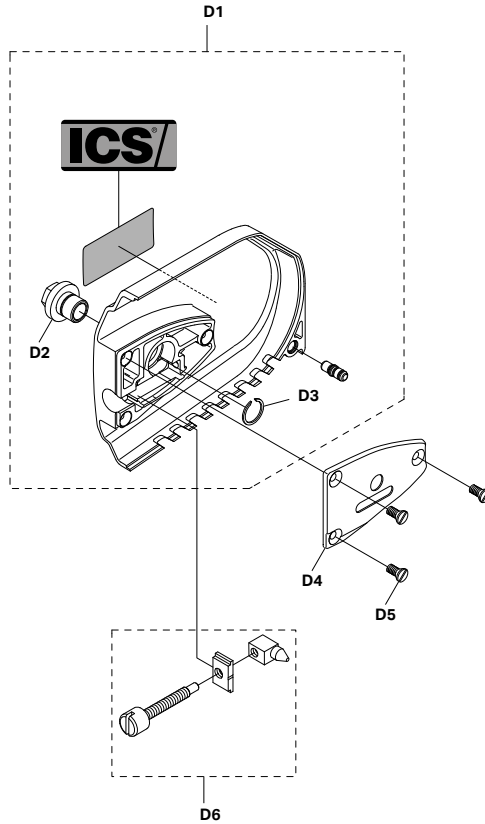

Key #	Part No.	Description
D1	543899	SIDE COVER ASSEMBLY
D2	543900	SIDE COVER NUT
D3	543901	SIDE COVER NUT CIRCLIP
D4	543902	TENSIONER COVER PLATE
D5	543903	SCREW, SIDE COVER CAP
D6	543904	TENSIONER

CYLINDER & EXHAUST ASSEMBLIES

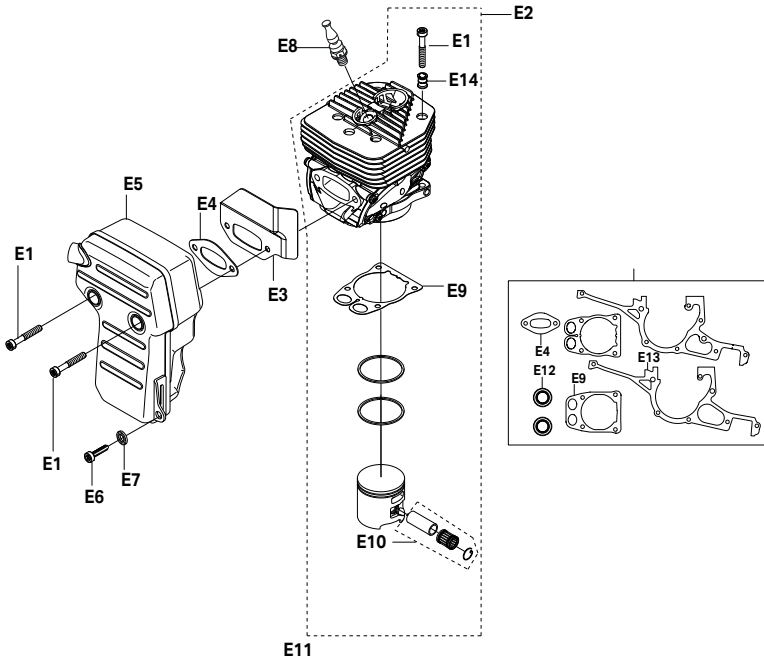

Key #	Part No.	Description
E1	543942	CYLINDER/MUFFLER SCREW
E2	576169	PISTON/CYLINDER KIT
E3	543844	HEAT DEFLECTOR
E4	543938	MUFFLER GASKET
E5	543845	MUFFLER
E6	543846	LOWER MUFFLER MOUNTING SCREW
E7	543847	MUFFLER MOUNTING WASHER
E8	576166	DECOMPRESSION VALVE
E9	576165	CYLINDER BASE GASKET
E10	543949	NEEDLE BEARING
E11	543936	GASKET KIT
E12	543931	SEALING RING
E13	543933	CRANKCASE GASKET

CRANKCASE ASSEMBLY

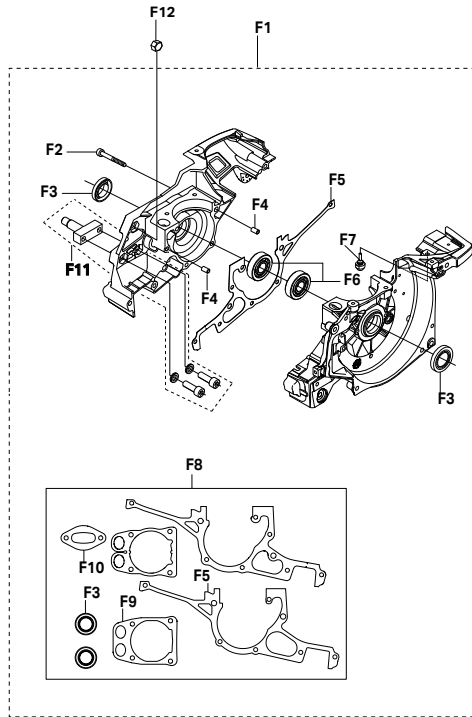

Key #	Part No.	Description
F1	543929	CRANKCASE ASSEMBLY
F2	543930	CRANKCASE SCREW
F3	543931	SEALING RING
F4	543932	GUIDE BUSHING
F5	543933	CRANKCASE GASKET
F6	543934	MAIN BEARING
F7	543935	RUBBER BUSHING
F8	543936	GASKET KIT
F9	543937	CYLINDER BASE GASKET
F10	543938	MUFFLER GASKET
F11	544129	BAR STUD KIT
F12	543941	BAR BRACKET FASTENER

CRANKSHAFT ASSEMBLY

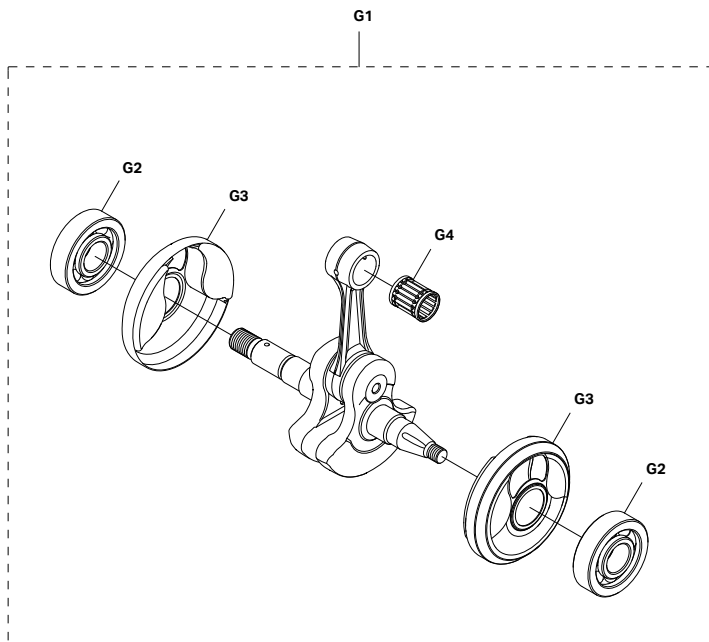

Key #	Part No.	Description
G1	543952	CRANKSHAFT ASSEMBLY
G2	543934	MAIN BEARING
G3	543953	CRANKSHAFT SHIELD
G4	543949	NEEDLE BEARING

CARBURETOR & INTAKE ASSEMBLIES

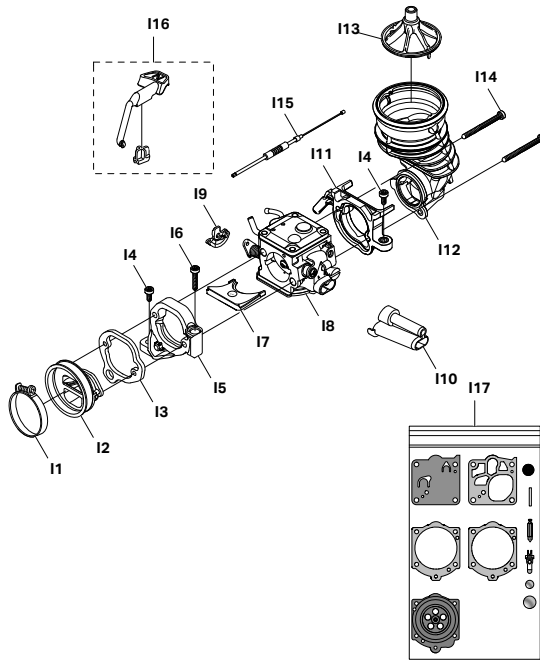

Key #	Part No.	Description
I1	544069	INLET BOOT CLAMP
I2	544070	INLET BOOT
I3	544071	FLANGE
I4	544072	FLANGE CLUTCH SIDE SCREW
I5	544073	FLANGE BRACKET
I6	544065	SCREW
I7	544074	SEPARATOR PLATE
I8	544075	CARBURETOR (WALBRO RWJ-7)
I9	544111	THROTTLE CABLE LEVER
I10	576168	ADJUSTMENT GUIDE
I11	544112	MANIFOLD BRACKET
I12	544113	AIR INTAKE MANIFOLD
I13	544114	AIR FILTER BRACKET
I14	544115	CARBURETOR MOUNTING SCREW
I15	543975	THROTTLE CABLE ASSEMBLY
I16	544117	CHOKE LEVER
I17	576161	CARBURETOR REPAIR KIT (Only for 695XL, will not fit 695GC/F4/PG)

CYLINDER AND AIR FILTER ASSEMBLIES

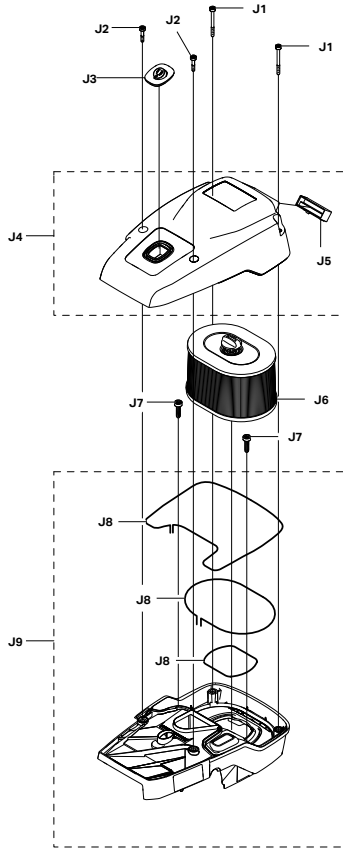

Key #	Part No.	Description
J1	544060	FILTER COVER REAR SCREW
J2	544061	FILTER COVER FRONT SCREW
J3	576167	PLUG (may be required on older 695GC/F4 models)
J4	544062	FILTER COVER
J5	544063	AIR INTAKE INSERT
J6	544064	AIR FILTER
J7	544065	CYLINDER COVER SCREW
J8	544067	CYLINDER COVER SEALS
J9	544066	CYLINDER COVER ASSEMBLY

FUEL TANK ASSEMBLY

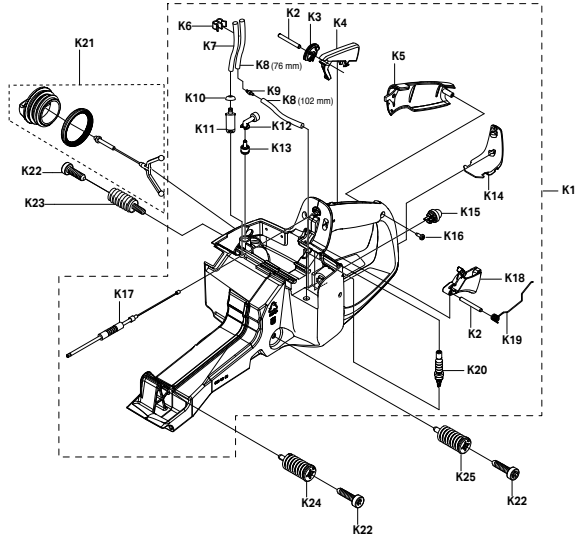

Key #	Part No.	Description
K1	543812	FUEL TANK ASSEMBLY
K2	543813	PARALLEL PIN
K3	543814	CABLE LEVER
K4	543815	THROTTLE LOCK OUT LEVER
K5	543816	REAR HANDLE COVER
K6	543818	CLIP
K7	543993	FUEL LINE
K8	543994	CHECK VALVE TUBE
K9	543969	CHECK VALVE
K10	543970	HOSE CLAMP
K11	543971	FUEL FILTER
K12	544990	TANK VENT ELBOW
K13	544122	TANK VENT
K14	543972	REAR HANDLE GROUND SUPPORT
K15	543973	PURGE BULB
K16	543974	REAR HANDLE SCREW
K17	543975	THROTTLE CABLE ASSEMBLY
K18	543976	THROTTLE TRIGGER
K19	543977	TRIGGER SPRING
K20	543995	PURGE BULB TUB
K21	543979	GAS TANK CAP ASSEMBLY
K22	543981	SHOCK ABSORBER SCREW
K23	543982	SHOCK ABSORBER CLUTCH SIDE
K24	543983	SHOCK ABSORBER FRONT
K25	543984	SHOCK ABSORBER FLYWHEEL SIDE

WATER DELIVERY SYSTEM

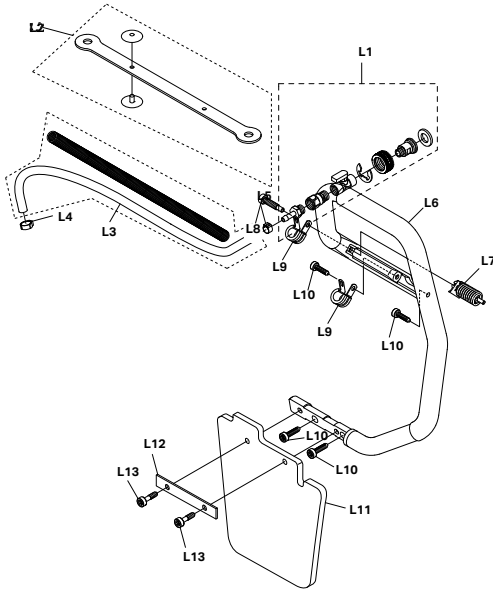

Key #	Part No.	Description
L1	543996	WATER HOSE VALVE ASSEMBLY
L2	547969	HOSE HANGER
L3	543999	WATER HOSE WITH PROTECTIVE COVERING
L4	544000	CLAMP, WATER HOSE
L5	544001	CLAMP, WATER HOSE VALVE SIDE
L6	544002	FRONT HANDLE
L7	544003	SHOCK ABSORBER, FRONT HANDLE
L8	543981	SCREW, SHOCK ABSORBERS
L9	544008	CLIP, FRONT HANDLE
L10	544009	SCREW, FRONT HANDLE
L11	576679	MUD FLAP
L12	544011	BACKING PLATE, MUD FLAP
L13	544012	SCREW, MUD FLAP

5. This section covers the removal, inspection, and assembly of the air intake.

5.1

Loosen the air filter cover screws and remove the air filter cover.



5.2

Loosen air filter screw.

- Inspect air filter for dirt or damage.
- Replace with P/N 544064.



6. This section covers the removal, inspection and installation of the spark plug.**6.1**

Remove the spark plug cap.

**6.2**

Remove the spark plug.

**6.3**

Inspect spark plug.

- If it's dirty, clean with a wire brush.
- Replace spark plug if fouled or eroded. USE NGK BRMR7A or Champion RCJ6Y.



6.4
Gap if necessary to 0.20" (0.5mm).



6.5
Assemble in reverse order ensuring that the spark plug is properly engaged in threads and fully seated.



7. This section covers side cover removal, side cover nut removal, inspection and assembly.

7.1

Loosen side cover nut.

- Remove side cover.
- Remove tensioner plate screws and tensioner plate.



7.2

Remove tensioner assembly.

Note the orientation of the tensioner assembly.

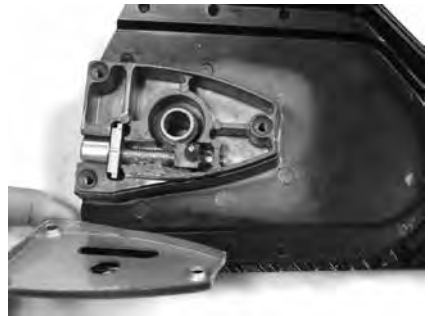

7.3

Inspect tensioner and replace if needed.

- Clean tensioner threads and liberally apply grease to threads prior to assembly.



7.4

Inspect side cover, nut and circlip.
Replace if damaged.

Circlip can be removed with a large
flathead screwdriver.



7.5

Assemble in reverse order.



8. This section covers clutch removal, rim sprocket removal, inspection and assembly. Refer to sections 5 and 6 if necessary.

Rim sprocket removal procedure.



8.1

Using flat head screwdriver, remove retaining ring.

* Use caution when removing retaining ring to prevent damage to the split retainer or crankshaft.



8.2

Remove the split retainer and spacer.



8.3

Inspect rim sprocket and replace if necessary (P/N 70949).

- Replace if the rim sprocket teeth are worn to points as shown on right.

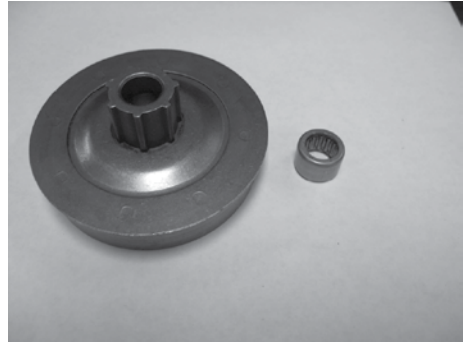

8.4

Rim sprocket assembly.

- Assemble in reverse order.

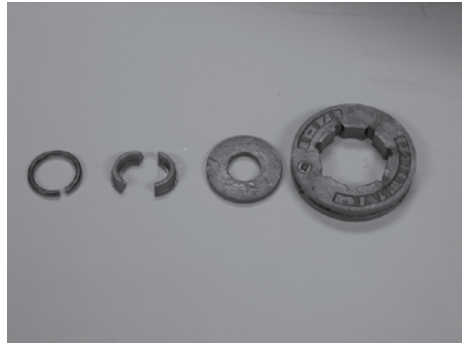

8.5

Remove clutch cup and needle bearing.

- Apply grease to needle bearing prior to reinstalling.

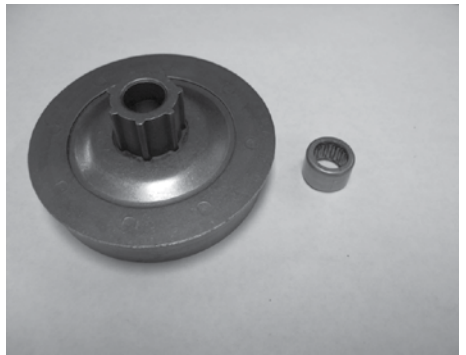

8.6

Clutch removal.

- Remove clutch cup & rim sprocket first.



8.7

Insert piston stop tool into spark plug hole.



8.8

Remove clutch with clutch tool (P/N 546659).

- Rotate clockwise to remove clutch (clutch is left-handed thread).



8.9

Clutch is marked with arrow (off) for direction of removal.

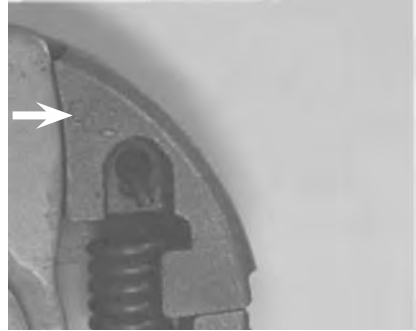

8.10

Inspect clutch shoes (P/N 543927 - CHECK - I can't find this p/n in the RPPL) for excessive wear or damage.



8.12

Height of clutch shoes should not be less than 1 mm.

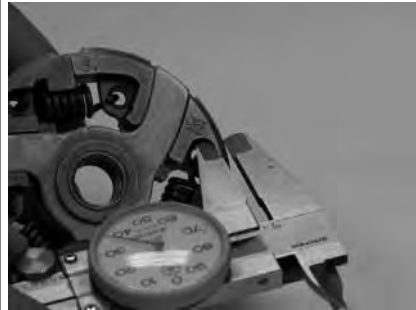

8.12

Inspect and clean springs if necessary.



8.13

Remove the springs.

- Set into a vice to hold in place.
- Place a flat head screwdriver or flat tipped rod against the spring hook.
- Tap lightly at the end of the screwdriver or rod. This will cause the spring hook to detach.

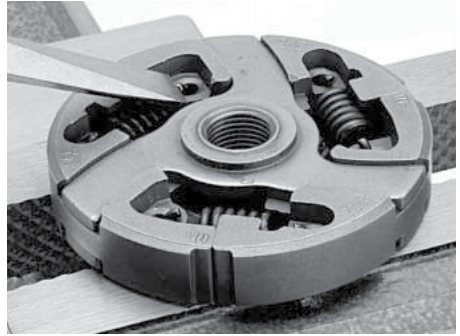

- Push the spring out.
- Repeat with the remaining two springs.

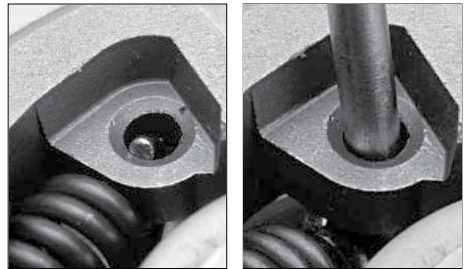

8.14

Fit clutch shoes.

- Slide the spring into the narrower section of the clutch shoe first.

NOTE: All spring hooks should point the same direction as the word "OFF". See illustration at right for an example.

8.15

Fit springs.

- Turn the clutch so the word "OFF" is facing down.
- Push the spring hook into its hole by using a pointed tool.

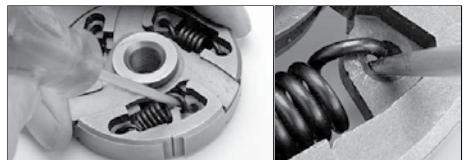
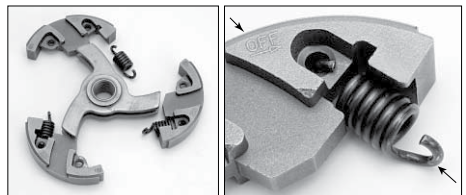

9. This section covers the removal of the starter cover, replacement of the starter rope and replacement of the recoil spring.

9.1

Loosen (4) starter cover screws.

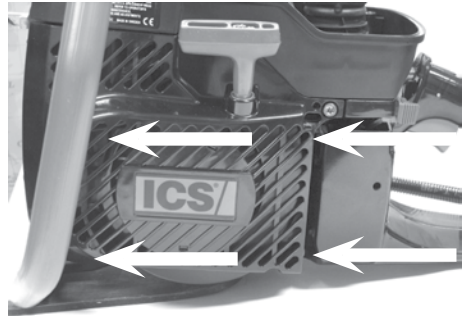

9.2

Remove starter cover from the power cutter.

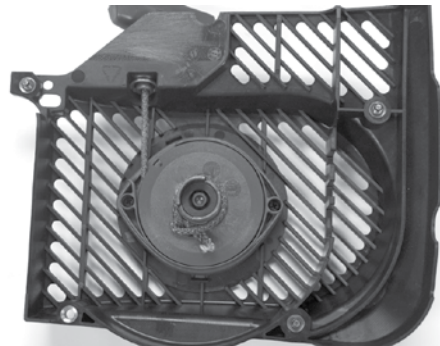

9.3

Relieve spring tension in starter recoil.

- Pull 6 - 8 in (15 - 20 cm) of rope out.
- Line up rope with notch in pulley.

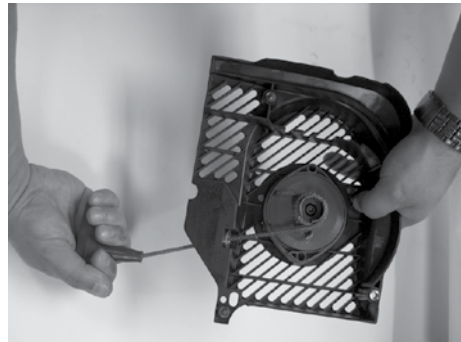

9.4

Rotate pulley shaft counter clockwise, allowing pulley to unwind using rope as a brake.



9.5

Pulley removal from spring.



9.6

Remove the center screw and components.

Note the orientation of the parts.

refer to photo (9.7).



9.7

Note the orientation of the parts for re-installation.



9.8

A. Lift pulley from spring housing. NOTE: the spring catch and spring hook must be aligned during installation (arrows).

B. Remove the two screws holding the spring housing.

C. Use CAUTION when removing the spring to prevent the spring from unwinding.

D. Inspect spring and lubricate with light oil.

E. Align notch in spring housing with end of spring.

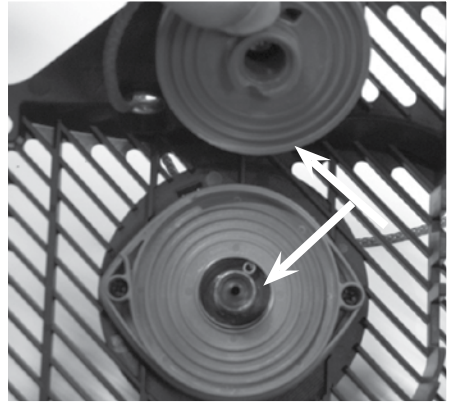

9.9

Inspect rope (P/N 544023) and pulley (P/N 544127). Replace if necessary. Note the orientation of the knot.



9.10

Assemble in reverse order.

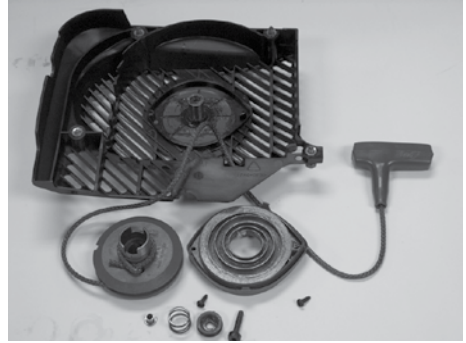

9.11

Install the center screw and components. Note the orientation of the parts for re-installation. See 9.7 for orientation.

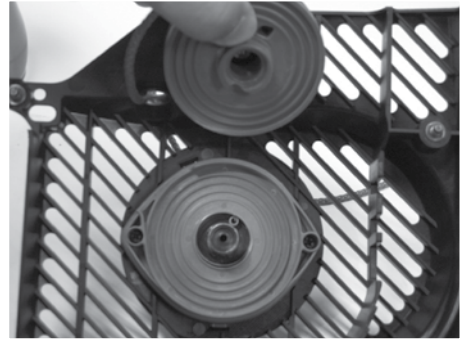

9.12

Tension pulley.

- Wind rope onto pulley clockwise, leaving 6-8 in (15 - 20 cm) of rope out.
- Ensure the pulley spring catch is installed on the spring hook.



9.13

Insert the rope into the pulley notch.

- Wind rope clockwise around pulley shaft 3 - 4 times. Then pull starter rope handle.
- Repeat as necessary to ensure proper spring tension.
- Ensure with starter rope fully extended the pulley can still be rotated an additional 1/2-turn before being stopped by the spring.

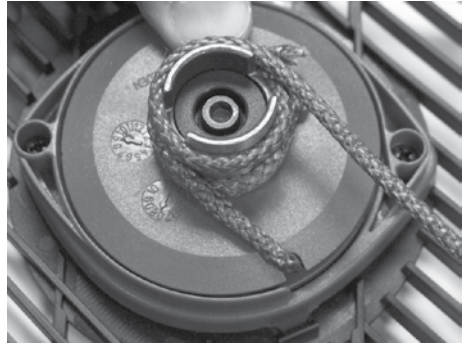

9.14

- Rope must fully retract into starter cover.

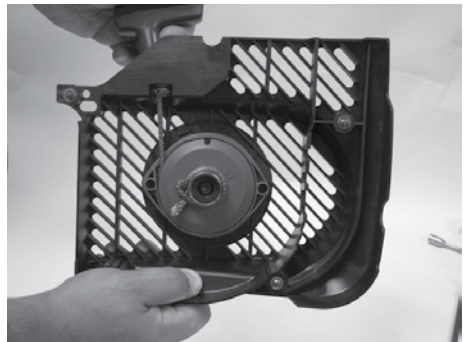

9.15

Install starter cover.

- Pull starter rope to engage starter pawls and seat cover.
- Tighten side cover screws.



10. This section covers the removal & replacement of the carburetor & cylinder cover. Removal of air intake components and front handle is required. Refer to sections 5 & 15 if necessary.

10.1

Remove air filter cover and air filter.
Refer to section 5.

Remove (2) screws (P/N 544065).

Lift cylinder cover off from the front of
the cover.

Install in reverse order using Loctite® 242

**10.2**

Carburetor Removal.

Remove choke lever (P/N 544117).

**10.3**

Lift up choke lever and rotate 90 degrees
then pull out from carburetor.

Install in reverse order.



10.4

Remove (2) carburetor mounting screws (P/N 544115) using a Workshop Key Torx T27 (P/N 546191).

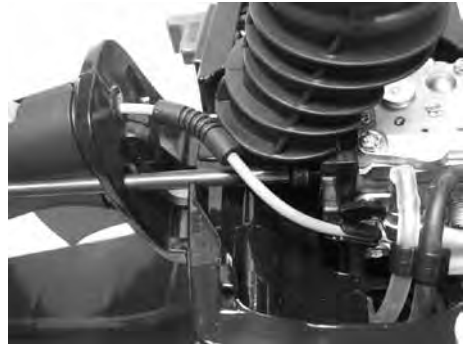

10.5

Remove flange screw (P/N 544072).

Remove air intake manifold (P/N 544113).

Inspect for damage.



10.6

Remove fuel line, check valve tube and carburetor.



10.7

Remove throttle cable from carburetor.

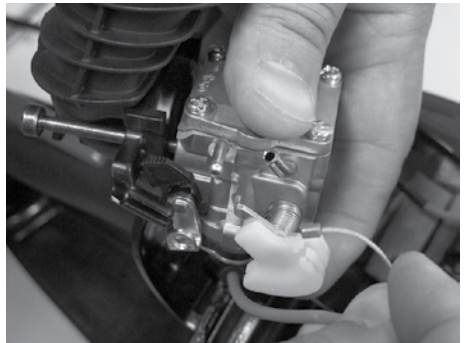
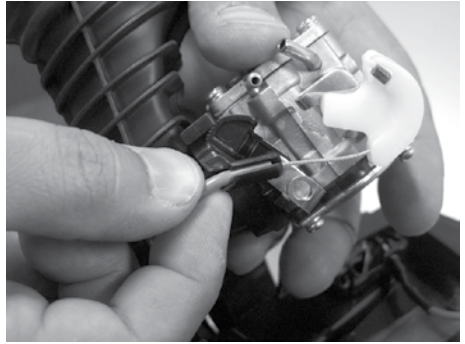

10.8

Remove clutchside flange screw (P/N 544072) and screw (P/N 544065).

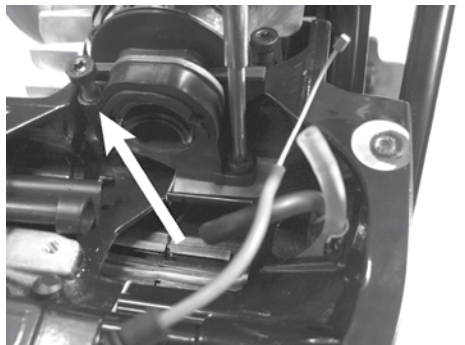

10.9

Remove plate from inlet boot.

Remove the flange bracket and flange from the inlet boot.

Note orientation of plate "UP".



10.10

Loosen clamp.

Inspect and replace inlet boot if damaged (see section 16.2).

- Cylinder must be loosened in order to remove the inlet boot.
- Install in reverse order.
- Using Loctite® 242 for screws.
- Note orientation of plate "UP".



11. This section covers the removal, inspection and assembly of the muffler. Removal of WallWalker® and cylinder cover is required. Refer to section 10 if necessary.

11.1

Muffler removal.

- Remove (2) cylinder/muffler screws (P/N 543942) with srench.
- Remove (1) lower muffler mounting screw (P/N 543846) and muffler mounting washer (P/N 543847).



11.2

Inspect and replace if damaged.

- Muffler (P/N 543845).
- Muffler gasket (P/N 543938).
- Heat Deflector (P/N 543844).

Reassemble in reverse order using Loctite® 242.



12. This section covers the removal, inspection and installation of the guide bar stud. Removal of WallWalker® and muffler is required. Refer to section 10 if necessary.

12.1

Bar stud removal (P/N 544129).

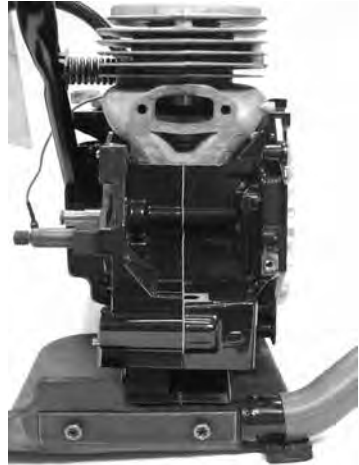

12.2

Using a 6 mm allen or hex head, remove (2) bolts holding bar stud.

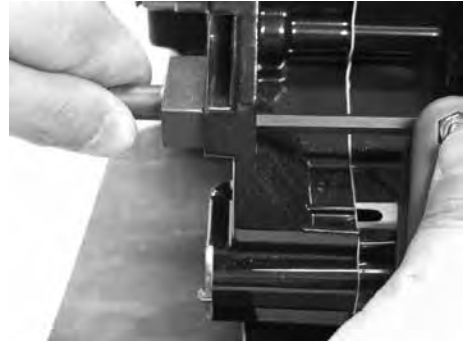

12.3

Inspect bar stud (P/N 544129).

- Replace if damaged.
- Install in reverse order using Loctite®242.



13. This section covers the removal, inspection and installation of the ignition module. Removal of the starter is required. Refer to section 8 if necessary.

13.1

- Remove starter cover.
- Remove starter cover shield.
- Disconnect the stop switch cable.
- Inspect and replace if damaged (P/N 544032).

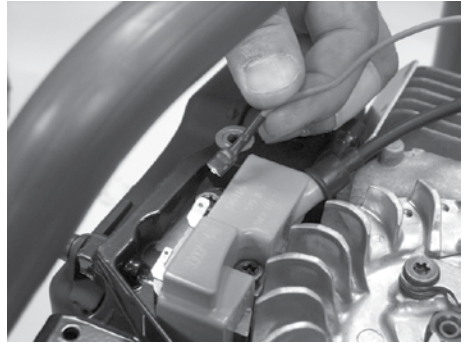

13.2

- Remove (2) ignition module screws (P/N 544038).
- Remove ignition module (P/N 544036).
- Inspect and replace if damaged.

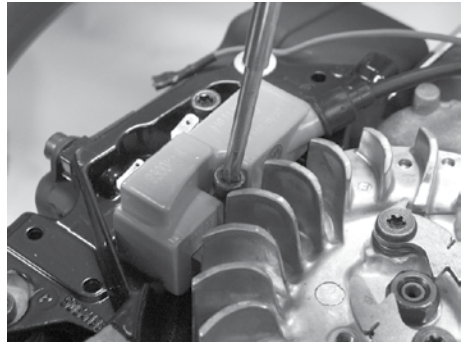

13.3

Reassemble in reverse order.

Place air gap gauge (.010 in/0.3 mm) on the magnet side of the flywheel.

- Set ignition module in place.
- Install ignition module screws with blue Loctite® 242.
- Holding gauge, rotate flywheel magnets around to coil.
- Torque ignition coil screws to 89-105 in/lbs (10 - 12 Nm).
- Remove gauge, rotate flywheel and check for clearance.
- Connect stop switch cable.

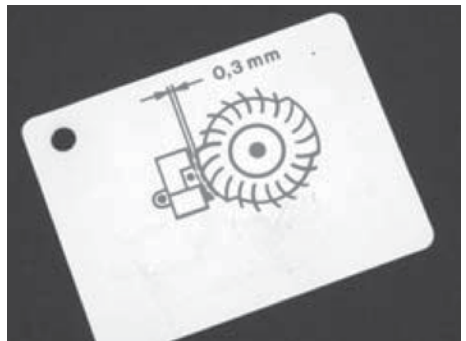

14.1
Remove stop switch (P/N 544031).

Disconnect cable wire.

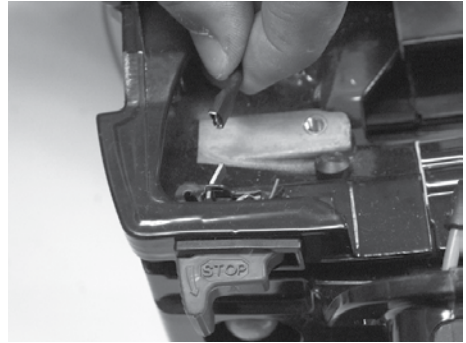

14.2
Remove screw (P/N 544030).

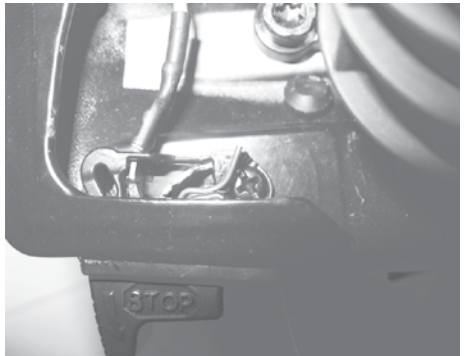

14.3

Pry the switch to the left using the screwdriver.



14.4

Pull the right side out first.

- Replace switch if damaged.
- Install in reverse order.
- Switch will snap back into place.
- Use Loctite®242 only on screw.



15. This section covers water hose and water tank cap.

15.1

Inspect hose (P/N 543999), water pipe (P/N 543915) and water valve (P/N 543996).

Replace if damaged.



15.2

Release clip from water inlet pipe.
Pull hose upward.

Inspect hose and water inlet pipe,
replace if damaged.



16. This section covers the removal, inspection and assembly of the cylinder, piston and related components. Refer to section 5 & 10 if necessary

16.1

Remove outer shock absorber screw (set aside for reassembly) (P/N 543981).

Loosen (4) cylinder screws(P/N 543942).

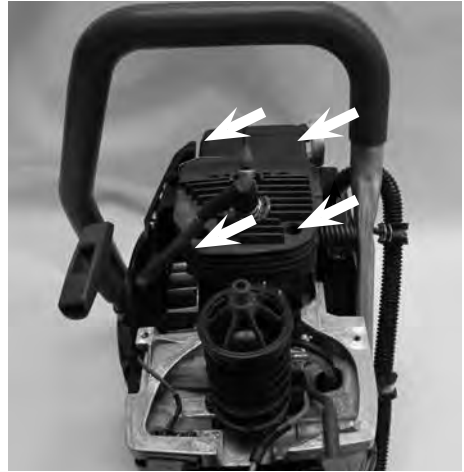

16.2

Remove cylinder from piston.

Remove shock absorber screw (see section 16.1).

Remove inlet boot and clamp. Set aside shock absorber, boot & clamp for reassembly later (see section 10.9).

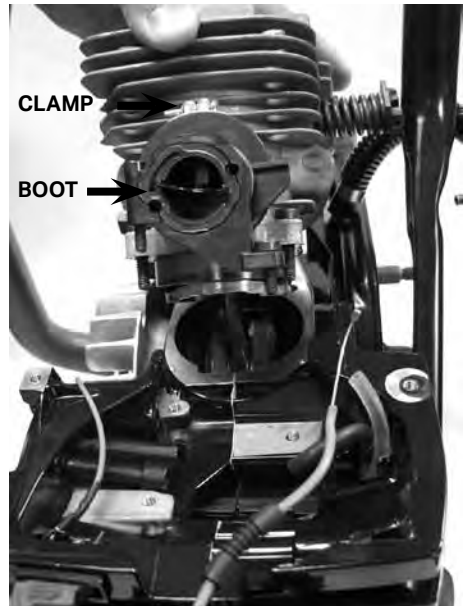

16.3

Remove wrist pin clip from each side of piston.



16.4

Remove wrist pin using the wrist pin punch (P/N 543196).

Remove piston and cylinder base gasket.



16.5

Clean crankcase.



16.6

Inspect cylinder and piston (P/N 543843)
replace if damaged.

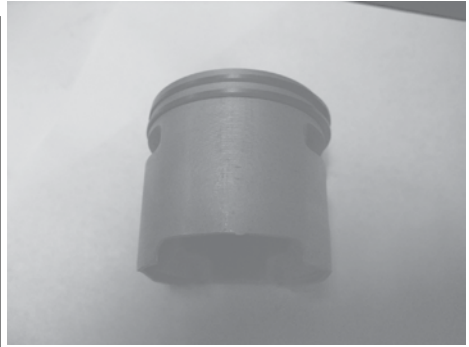

16.7

Install piston rings.
Install lower piston ring first.

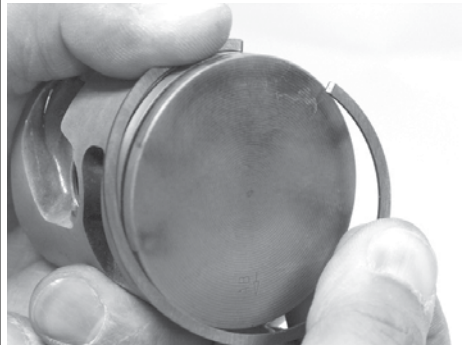

16.8

Note the ring locator pins.

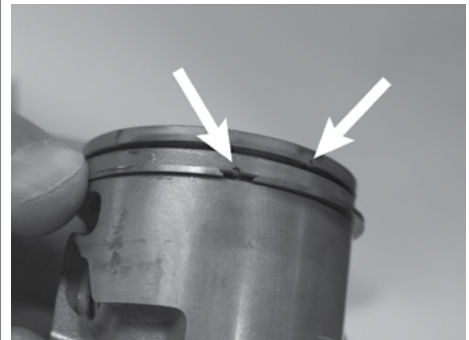

16.9

Note ring orientation.

*If rings are installed upside down or incorrectly, ring will not seat properly and piston damage will occur.

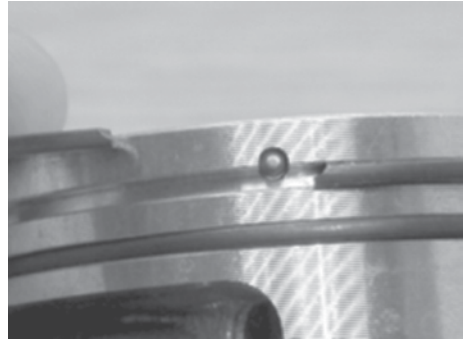

16.10

Lubricate crankcase gasket mating surface with ICS® 2-stroke oil.

Install cylinder base gasket.

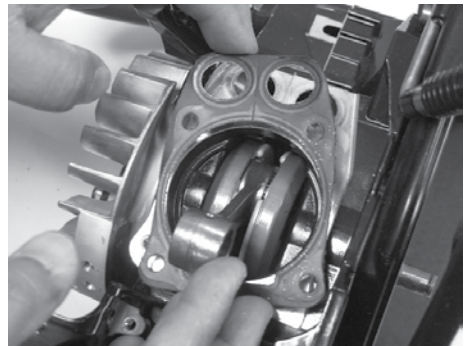

16.11

Lubricate needle roller with ICS® 2-stroke oil. Insert into the connecting rod.



16.12

Lubricate wrist pin with ICS® 2-stroke oil and partially install in the piston.

**16.13**

Install wrist pin clip into opposite side of the piston.

Make sure wrist pin clip is in the proper orientation.

See 16.15

**16.14**

Align the piston in correct orientation. Arrow on top of the piston points towards the muffler/exhaust port.

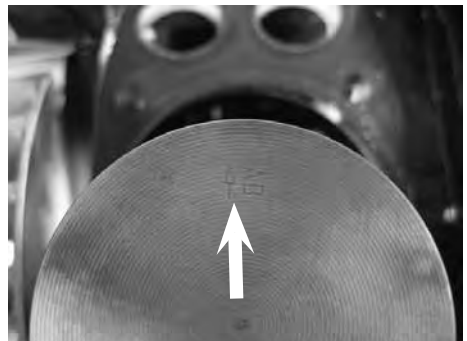

16.15

Install piston.

- A.) Align wrist pin with wrist pin needle bearing.
- B.) Complete wrist pin installation.
- C.) Install second wrist pin clip (note the orientation of the pin clips).
- D.) Coat piston with ICS® 2-stroke oil.

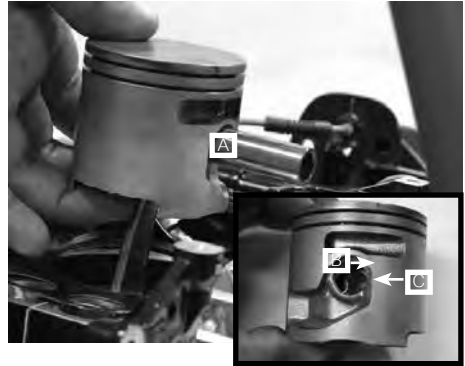

16.16

Install the inlet boot clamp, flange bracket, flange and shock absorber screw before cylinder installation.

- A.) Lubricate the cylinder bore with ICS® 2-stroke oil.
- B.) Compress the rings with compression tool (P/N 71543).
- C.) Slide cylinder onto piston, pushing ring tool down.
- D.) Remove ring compressor.
- E.) Slide cylinder onto piston and into the crankcase.
- F.) Align cylinder bolt holes with crankcase. Align cylinder screw with holes on gasket & crankcase.

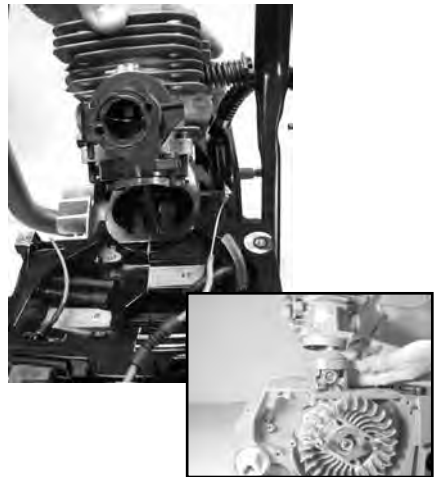

16.17

Install (4) cylinder screws using Loctite®242. Torque to 132-156 in-lbs (15 - 18 Nm).

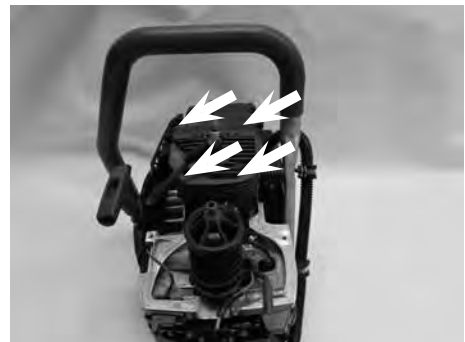

17. This section covers the removal, inspection and installation of the bottom guard and front handle.**17.1**

Remove (2) screws (P/N 544012) and guard flap backing plate (P/N 544011).

Inspect guard flap for damage (P/N 544010) replace if damaged.

Reassemble in reverse order using Loctite®242.

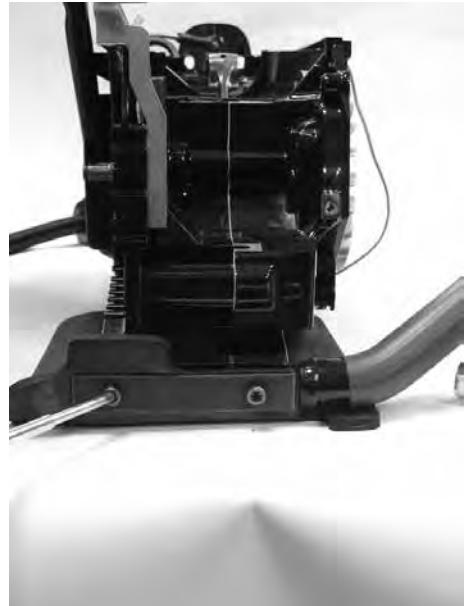
**17.2**

Remove (2) screws from lower front handle (P/N 544009).

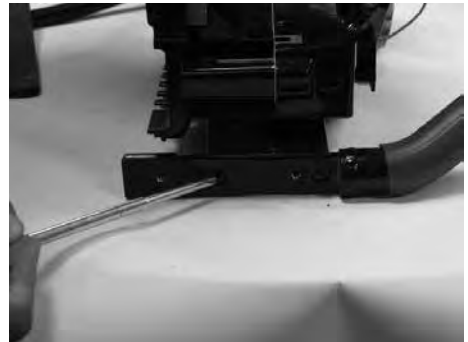

17.3

Remove (3) screws on the side of the handle (P/N 544009).

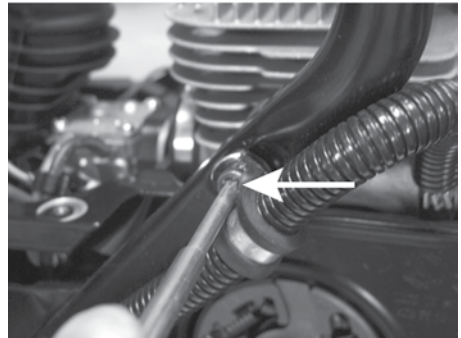
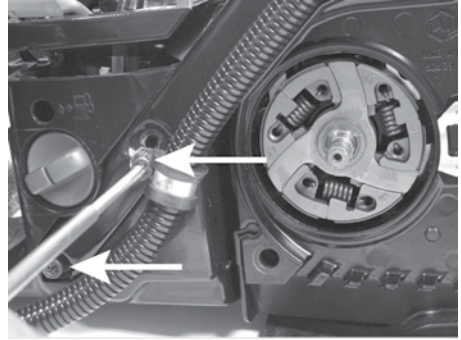

17.4

Lift up crankcase and remove handle, inspect and replace if damaged.

Install in reverse order

Use Loctite®242 on all screws except shock absorber screw.

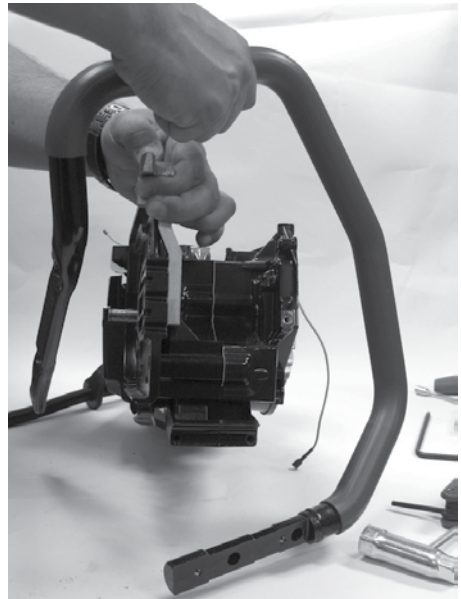

18. This section covers the removal, inspection and installation of the rear handle.

18.1

Remove screw from rear handle (P/N 543974).



18.2

Remove rear handle cover (P/N 543816).



18.3

Remove throttle lock out (P/N 543815) by squeezing, pulling up and out.

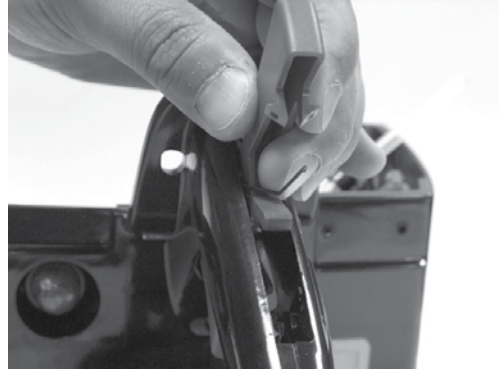

18.4

Remove throttle trigger (P/N 543976) by pushing the (2) parallel pins (P/N 543813) from the rear handle housing.



18.5

Pull the throttle trigger and spring (P/N 543977) down from the rear handle.



18.6

Remove throttle cable (P/N 543975)
See section 10 to remove cable from carburetor.



18.7

Remove cable lever (P/N 543814) using
needle nose pliers pulling up.



18.8

Remove throttle cable from cable lever using an awl or small punch.



18.9

Remove throttle cable through the front of the handle.



18.10

Inspect all throttle component parts.

- Replace if damaged.
- Reassemble in reverse order.



19. This section covers the removal, inspection, and assembly of the shock absorbers, fuel tank and components

19.1

Remove fuel cap (P/N 543979).

- Inspect fuel cap and O-ring.
- Replace if damaged.



19.2

Remove fuel filter (P/N 543971).

Use a small hook to remove filter from gas tank.



19.3

Remove fuel filter.

- Pull up on hose clamp (P/N 543970).
- Pull down on fuel filter.



19.4

Inspect fuel filter and line.

- Replace if damaged or dirty.
- Reassemble in reverse order.

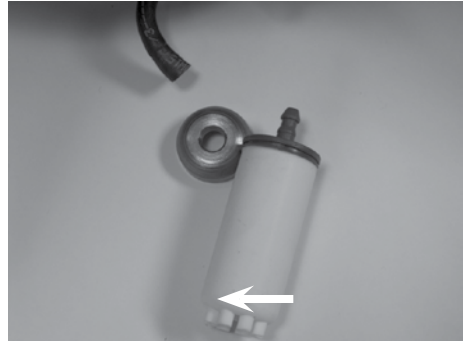

19.5

Before separating the fuel tank from crankcase, remove the front handle (see section 17) and throttle cable (see section 10).

Remove the (2) shock absorber screws from the clutch side of the power cutter.

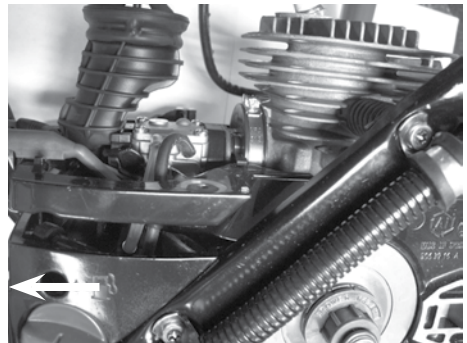

19.6

Remove the (2) shock absorber screws from the flywheel side of the power cutter.

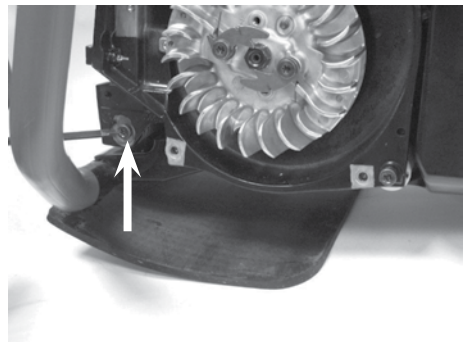

19.7

Separate fuel tank from crankcase by pulling up on the crankcase while holding the fuel tank.



19.8

Inspect Tank Vent Assembly.

Location of the tank vent on a disassembled power cutter.

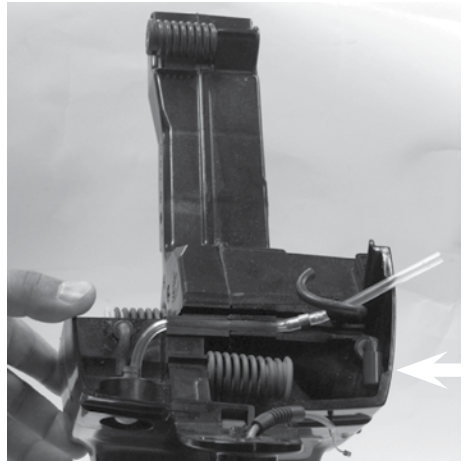

19.9

Location of the tank vent on an assembled power cutter.

NOTE: The breather assembly can be removed without removing the fuel tank.

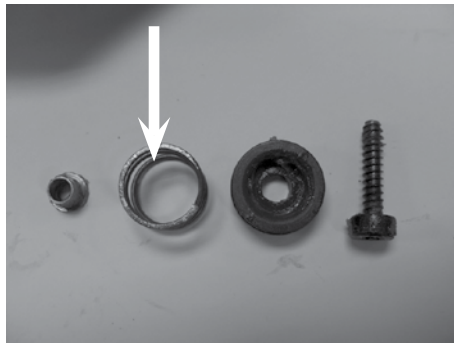

19.10

Using a small wedge, insert between the crank case and fuel tank to create more space.



19.11

Remove fuel cap and locate the fuel tank breather hole. The hole is directly in line with the breather assembly.



19.12

Using a small pick or Allen wrench, push the breather assembly up and out of the breather hole.



19.13

Assemble the tank vent elbow and tank vent by pressing together.

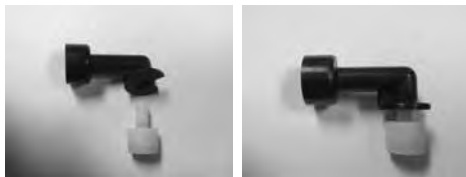

19.14

Insert the breather assembly by pressing directly over the elbow (see arrow at right) and vent into the breather hole.

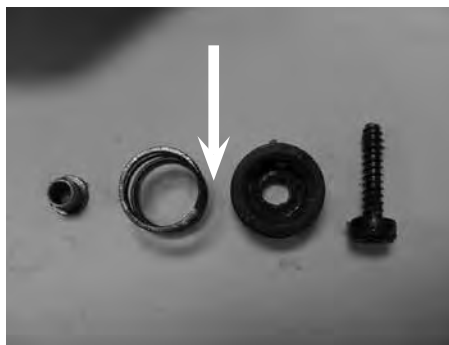

19.15

Inspect the tank vent and replace if damaged.
Refer to troubleshooting (section 25) if necessary.



19.16

Inspect fuel tank for damage.

Replace if damaged.



19.17

Shock Absorbers

Using the Workshop Key Torx T27 (P/N 546191), remove shock absorbers.

A.)Front shock absorber (P/N 543983).

B.) Clutch side shock absorber (P/N 543982).

C.)Flywheel side shock absorber (P/N 543984).

Inspect and replace if damaged.

Install in reverse order using Loctite® 242 (except Tank Vent).

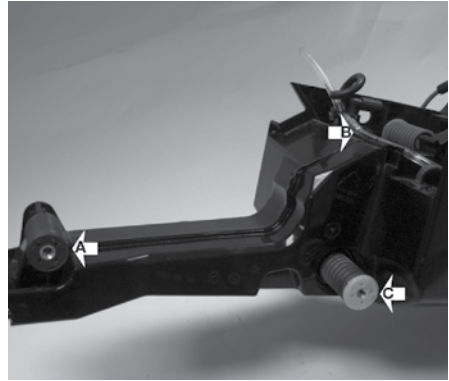

19.18

Purge bulb circuit.

Refer to troubleshooting (section 24) if necessary.

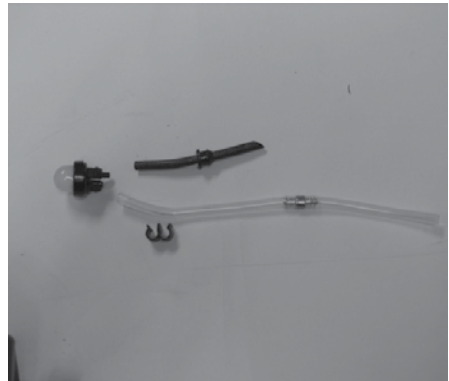

19.19

Disconnect the purge bulb tube, return line (P/N 543995) and disconnect check valve tube (P/N 543994).

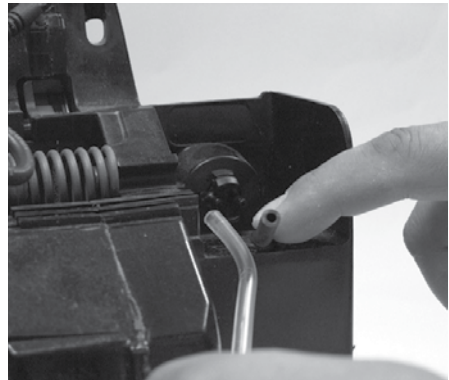

19.20

Remove purge bulb (P/N 543973) lightly depress tab to disengage purge bulb.

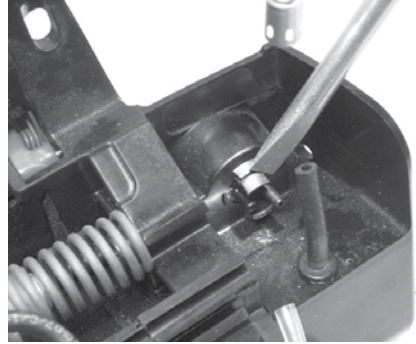

19.21

Inspect all components.

Replace if damaged. Check valve (P/N 543969) flows one way, ensure that it is installed correctly. Fuel flows towards the purge bulb.

Refer to troubleshooting (section 24) if necessary.

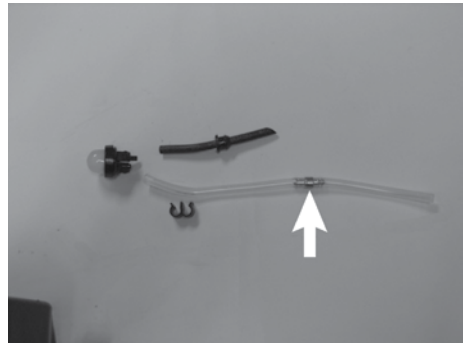

19.22

Reassemble in reverse order. Check valve tube must be inserted back into channel and connected to fuel line with clip. (P/N 543818).

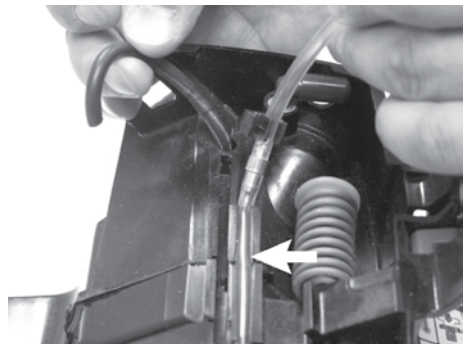

20. This section covers the disassembly, inspection and assembly of the crankcase seals and bearings.

20.1
Crankcase seal puller and punch.



20.2
Crankcase seals.



20.3
Seal removal.

A.) Insert T-handle puller over the shaft.
B.) Apply downward pressure to the T-handle and turn the barrel clockwise with a wrench to thread into the seal.

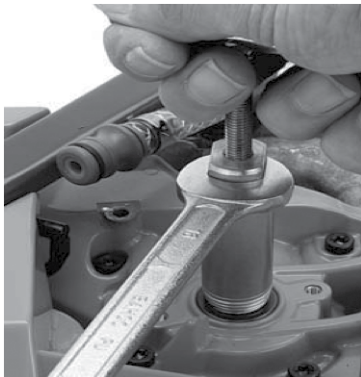

20.4

Turn the T-handle until it presses against the shaft and pulls the seal from the crankcase.

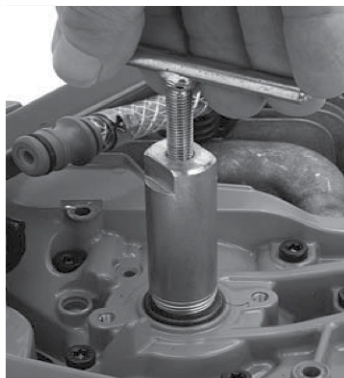

20.5

Lift off the seal and inspect the shaft for damage.



20.6

Lubricate the shaft with High Pressure Grease.



20.7

Install the new seal.

Use caution as seal slides over the threads.



20.8

Use the punch and soft mallet to tap seal into place.



20.9

Repeat procedure for the flywheel side.

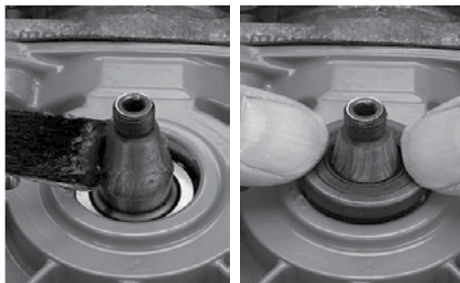

20.10

Using soapy water on both sides, perform a crankcase leak down test using pressure gauge and vacuum gauge.



20.11

Use pressure gauge to perform a leak down test. Pressure should hold at 7 psi (0.5 bar).

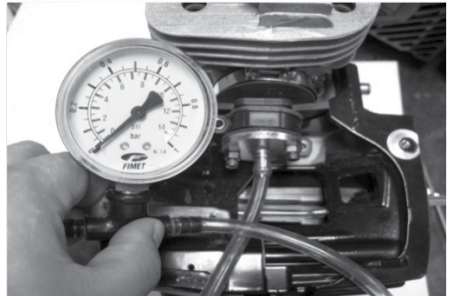

20.12

Crankcase separation.

The universal puller and grip plate are required to separate the crankcase.



20.13

Remove the shaft seals from both sides of the crankcase.

See seal removal.

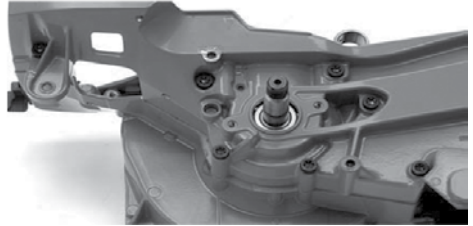

20.14

Install grip plate on the clutch side of the crankcase.

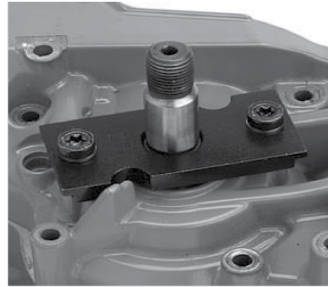

20.15

Attach universal puller and press out the crank shaft.

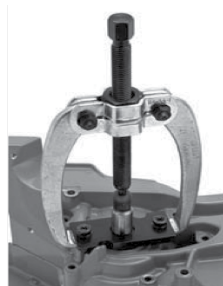

20.16

Using the same process, press out the other half from the flywheel side.

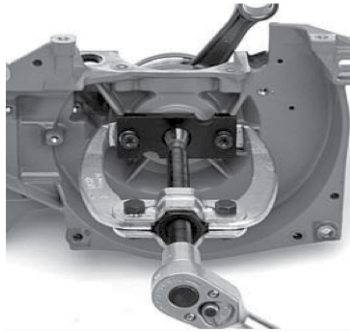

20.17

Separated crankcase halves with bearings installed.

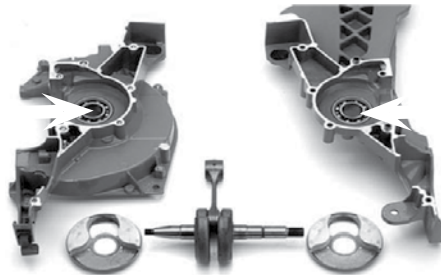

20.18

If the bearing(s) remain on the shaft upon separation, the bearing removal tool must be used.



20.19

Install the bearing clamp and tighten nuts.



20.20

Install the bearing puller and press the bearing off the shaft.

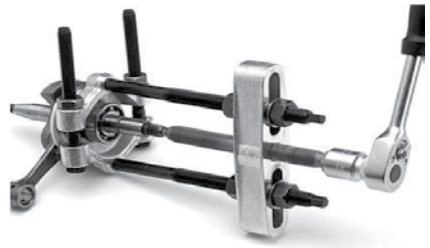

20.21

Crankcase bearing tools. These tools are required to remove the bearing from the crankcase.



20.22

Heat crankcase halves to 150°F (65.5°)
C. Use the shaft sleeve and soft mallet to
tap out both bearings.

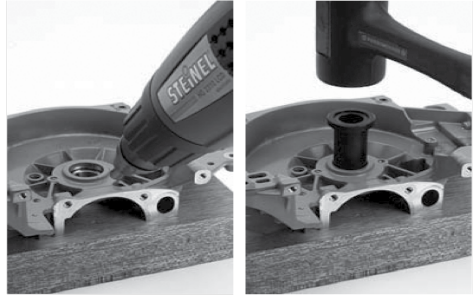

20.23

Bearing installation.
Bearing press tools.



20.24

Place the bearing on the bearing support
plate. Holding the bearing support plate
under the crankcase half.

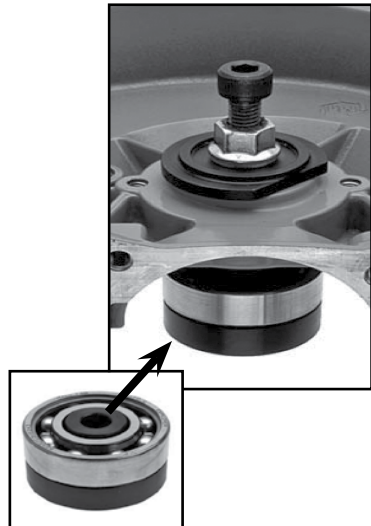

20.25

Place the screw with nut and washers through the crankcase support plate and thread into the bearing support plate.



20.26

Hold the screw in place and turn the nut until the bearing stops against the crankcase.

Repeat the process for the other half of the crankcase.

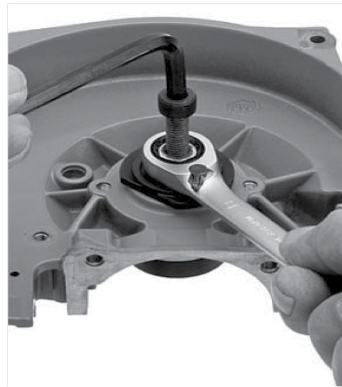

20.27

Bearing Tools.

Shaft Sleeve.

Shaft Mandrels.



20.28
Bearing press kit.



20.29
Crankshaft install.
Secure clutch side crankcase face down,
so the connecting rod is not pinched
against the crankcase.

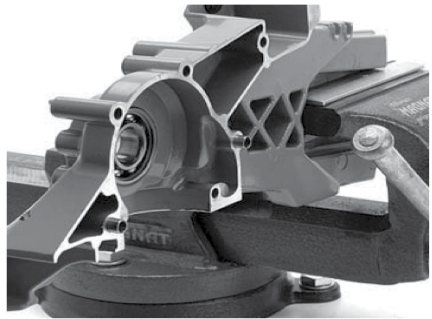

20.30
Slide the clutch side shaft through the
bearing.

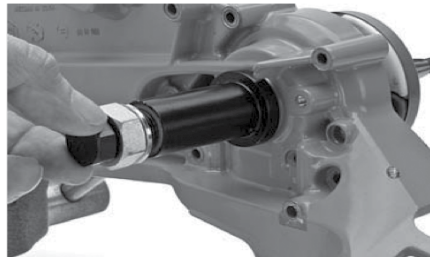

20.31

Slide the shaft sleeve over the shaft, against the crankcase. Thread the M12 mandrel with the nut and washer until it bottoms (Note - **REVERSE THREAD** on the clutch side).

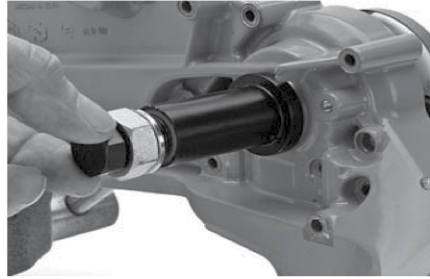

20.32

Hold mandrel in place, turn nut clockwise until the shaft reaches the top at the bearing. Ensure the connecting rod is not pinched against the case.

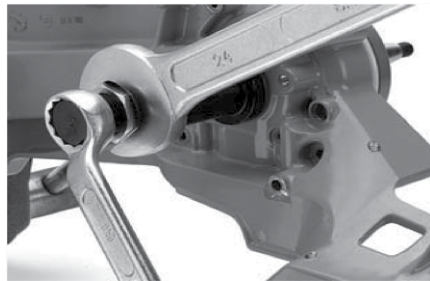

20.33

Install the (2) crankcase guide pins.

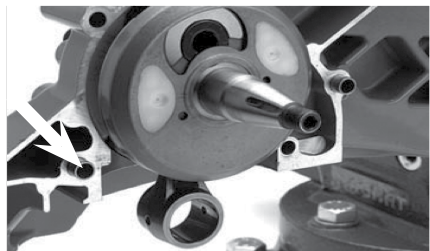

20.34

Lubricate the crankcase halves with ICS® 2-stroke oil and install the crankcase gasket.



20.35

Lubricate and assemble the flywheel side of the crankcase using the same method, with the M8 standard thread mandral. Ensure the connecting rod does not become pinched between the crankcase halves.



20.36

Loctite®242 and prefit the (8) screws and align the guide pins before bringing the crankcase together.

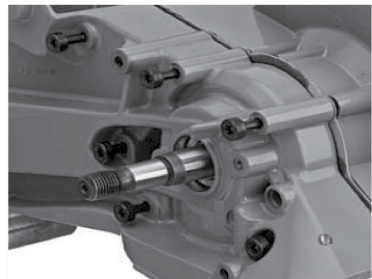

20.37

Tighten the screws to 106 - 124 in-lbs./
12 - 14 Nm using an "x" pattern.

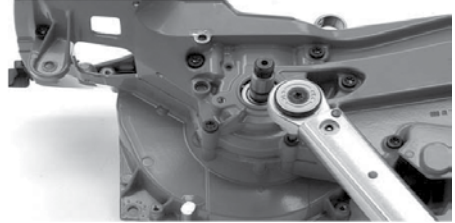

20.38

Cut the excess gasket over the cylinder
port and carburetor area. Tap both sides
of the shaft with a soft mallet and ensure
free movement of shaft and connecting
rod.



20.39

Install shaft seals (refer to section 20.7).



21. This section covers the carburetor tuning.

21.1

Carburetor tuning.
 A.) Throttle screw.
 B.) Low speed jet.
 C.) High speed jet.
 D.) Model number.

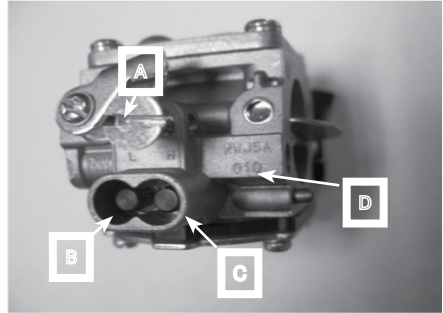

21.2

Tools required:
 Tuning screwdriver.
 Flat screwdriver.
 Tachometer.



21.3

Carburetor adjustment.
 Tachometer is required for proper tuning of the power cutter.



21.4

Throttle screw.

Basic setting:

T = 3 turns from closed.

Used to adjust chain speed at idle.

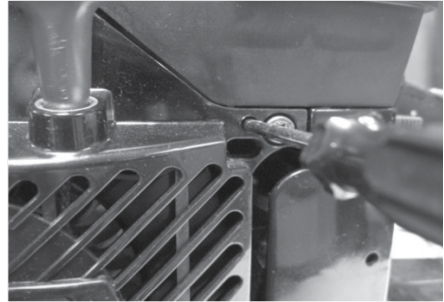

21.5

Carburetor basic setting:

H= 1 1/2 turns from closed.

L= 1 5/8 turns from closed.

Insert the tuning screw driver into the crankcase slot. Note the H screw is on the right as seen in the picture.

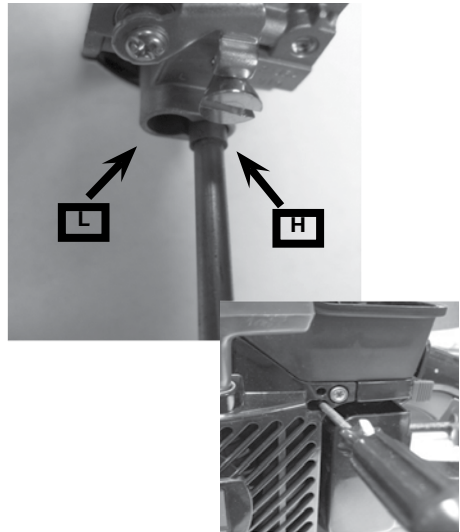

21.5a

Turn both the H and the L needle screws clockwise until they stop.

21.7

Turn the screws counter clockwise to the carburetor basic settings.

Carburetor basic setting:

H= 1 1/2 turns from closed.

L= 1 5/8 turns from closed.

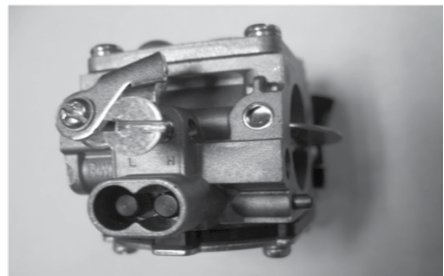

22.1

Verify the RPM's using the tachometer.

Start and warm up the power cutter

NOTE: This is a "no load" tuning procedure. The side cover must be securely fastened with a bar and chain.

Water MUST be used, failure to follow this procedure may result in personal injury and or damage to the power cutter.



22.2

Using the tachometer, check the power cutter RPM's at idle.

- Idle speed = 2700 RPM's +/- 150.
- Make minor adjustments using the throttle screw.

Using the tachometer, check the power cutter RPM's at full throttle.

- Full throttle target = 9300 RPM's +/- 150.
- Make minor adjustments using the throttle screw.



Do not hold the power cutter at maximum RPM for more than 5 seconds.

If the full throttle RPM falls below this range, turn the H needle clockwise 1/16 of a turn at a time, checking the RPM's at each interval.

NOTE: pulse the throttle to stabilize the system.

Once the carburetor is adjusted, install the chain to the proper tension and continue normal operations.

23. This section provides several flowcharts to aid diagnosing common problems.

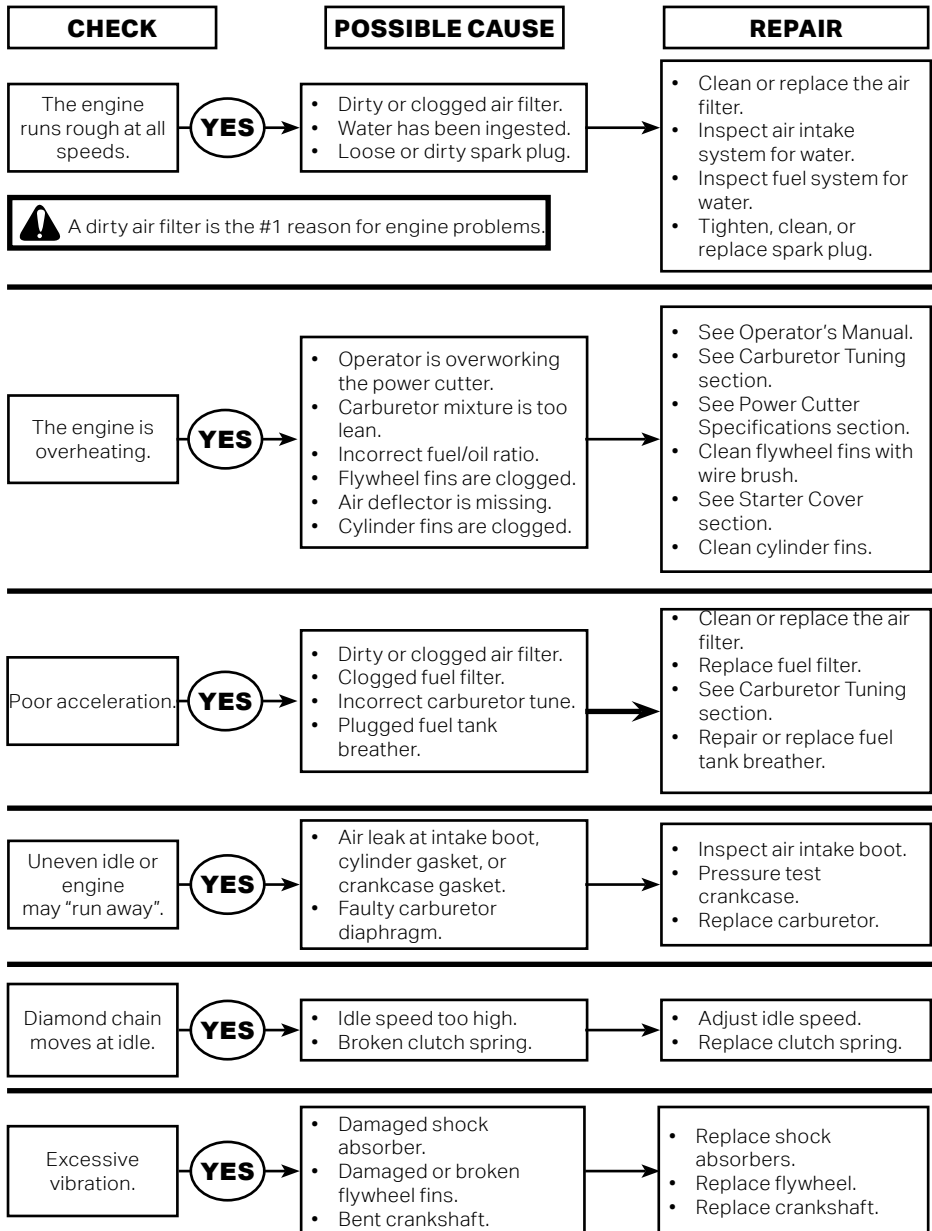

Power Cutter Will Not Start

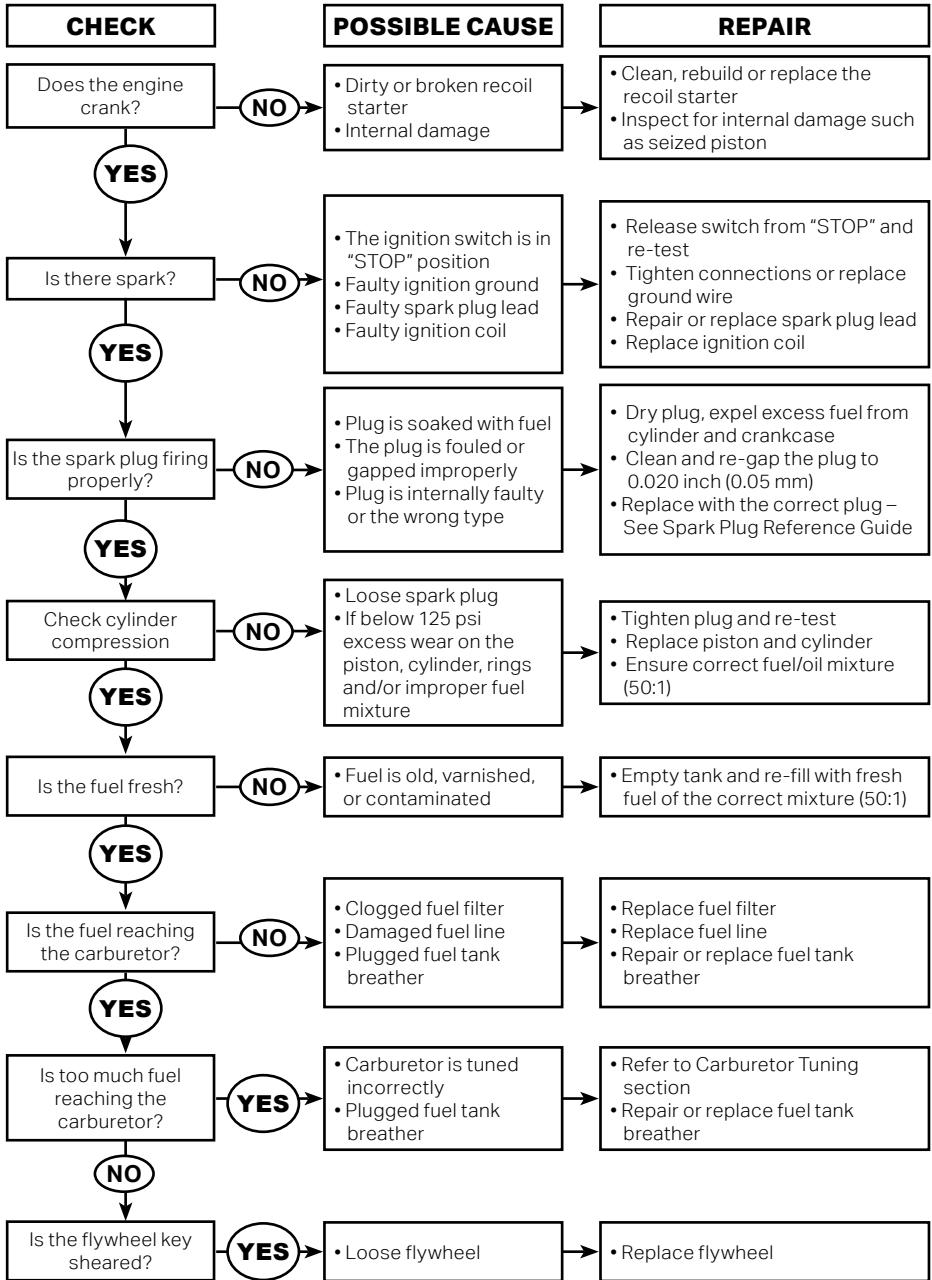

24. This section covers testing the fuel system.**24.1**

Engine starvation can result from a leak or malfunction of any of the main components of the fuel system.

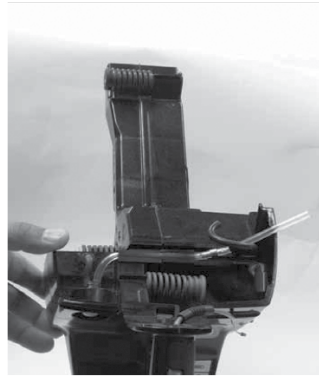
**24.2**

The main components are the fuel tank, fuel tank breather, fuel filter, purge bulb, delivery tubes and carburetor.

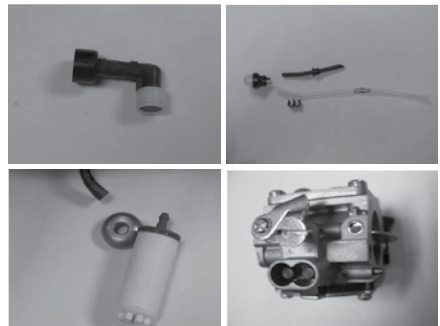
**24.3**

Remove and inspect the fuel filter.

Replace the fuel filter if the filter is excessively dirty or there is foreign material stuck to it.

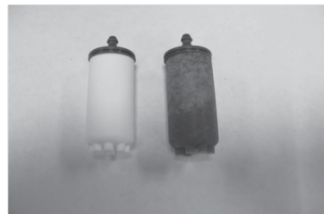

24.4

Test the main fuel pick-up for leaks.

Install the pressure gauge and bulb to the filter end of the fuel line.

Pressurize the tube to 7 psi (0.5 bar)

If the pressure does not maintain, separate the fuel line from the carburetor

24.5

Plug one end of the fuel pick-up tube.

Pressurize the tube to 7 psi (0.5 bar).

If the pressure holds, the leak has been isolated to the carburetor. Refer to the Walbro Carburetor Service Manual.

<http://wem.walbro.com/distributors/servicemanuals>



24.6

The fuel tank breather stabilizes the pressure in the fuel tank preventing both excessive pressure, which could flood the engine and negative pressure which could starve the engine of fuel.



24.7

The fuel breather is located above the fuel cap on top of the fuel tank.



24.8

Testing the fuel tank breather.

Attach the pressure gauge to the fuel tank plug. Plug the fuel line at the carburetor end. Pressurize the tube to 4.5 psi (0.3 bar).

The pressure should reduce to nearly 0 psi (0 bar) over a period of 3 seconds.



24.9

If the pressure does not release, disassemble or replace the breather.



24.10

Inspect the fuel purge circuit.

Inspect the purge bulb for leaks or damage. Replace if damaged. See fuel tank section.

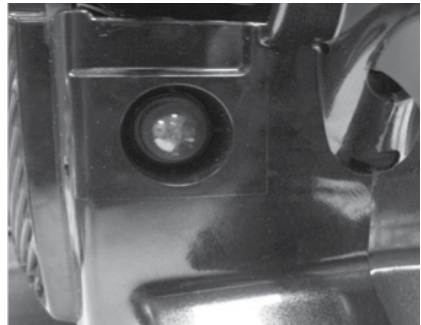

24.11

Inspect fuel purge lines and one way purge valve for leaks or damage. The arrow is the purge flow direction.

Replace if damaged. See fuel tank section.

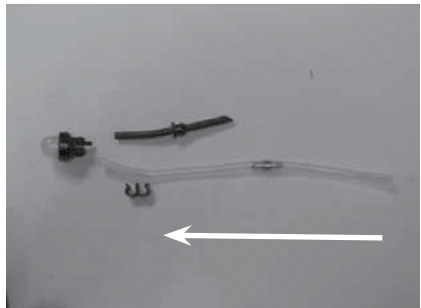

25. This section covers testing the crankcase for leaks. A crankcase leak can cause the engine to run too lean, causing engine damage, or not run at all.

25.1

- A.) Exhaust Seal Flange.
B.) Intake Seal Flange.

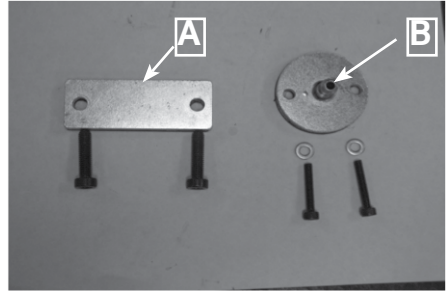

25.2

With the carburetor and muffler removed, block the intake and exhaust ports with the seal flanges.

See Cylinder Cover and Muffler sections.

NOTE: Remove intake plate from intake boot prior to installing intake seal flange.

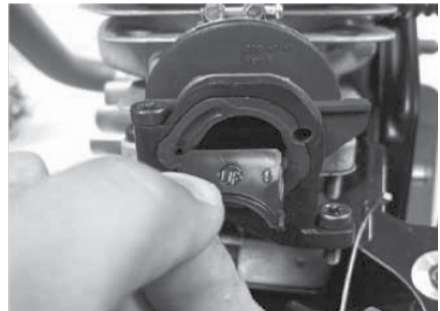

25.3

Securely plug or tape over the clutch needle roller lubrication port on the crankshaft.

Clutch cup and needle roller must be removed. See Clutch Cup and Rim Sprocket Section (section 8).

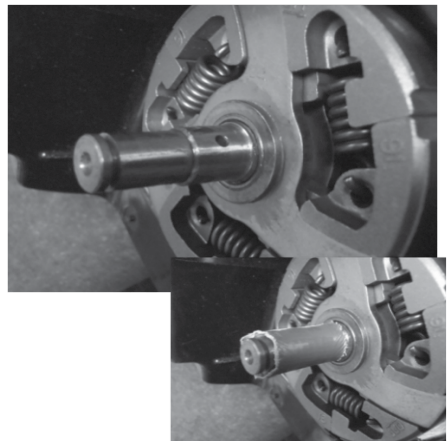

25.4

Install the exhaust seal flange.

Use the muffler mounting screws to install the flange.

Be sure the spark plug is secure and the decompression valve is pulled out.

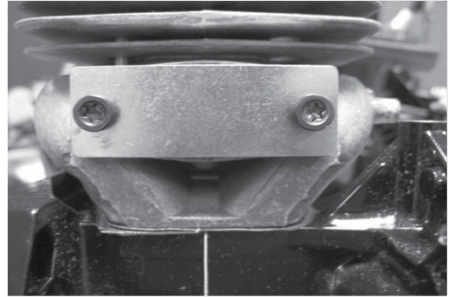

25.5

Install the intake seal flange.

Use M4 x 20 screws w/ washers (not supplied) to secure the seal flange.

Install the pressure gauge and pressurize the crankcase to 7 psi (0.5 bar). If the pressure does not hold, use soapy water to find the leak.

Note: it is recommended to pressure test the engine after a piston and cylinder rebuild, and or crank seal replacements.

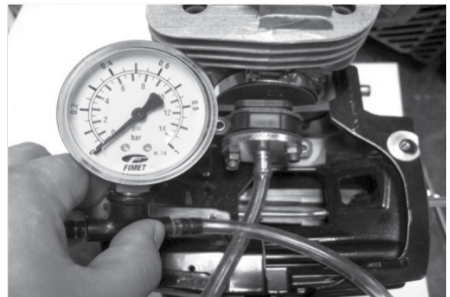

This appendix covers the removal, inspection, and installation of the spark plug for the 695XL.

Remove the spark plug lead.

Clean area around the spark plug to prevent debris from entering the cylinder.



Remove the spark plug.



Inspect the spark plug.

If dirty, clean with a wire brush as shown.



Gap if necessary to 0.02" (0.5 mm).

Champion RCJ-6 or NGK-BPMR7A

Assemble in the reverse order.

Make sure the plug boot is seated completely.



695XL SERVICE MANUAL

**ICS, Blount, Inc.
4909 SE International Way
Portland, OR 97222, USA
Tel 800.321.1240 Fax 503.653.4393**

**ICS, Blount Europe S.A.
Rue Emile Francqui, 5
1435 Mont-Saint-Guibert, Belgium
Tel +32 10 301 251 Fax +32 10 301 259
icsdiamondtools.com**