

SeeSnake® COMPACT M40



With
TruSense™
Technology

! WARNING!

Read this Operator's Manual carefully before using this tool. Failure to understand and follow the contents of this manual may result in electrical shock, fire, and/or serious personal injury.

For support and additional information about using your Compact M40 go to support.seesnake.com/compact-m40 or scan this QR code.



Table of Contents

Introduction

Regulatory Statements	3
Safety Symbols.....	3

General Safety Rules

Work Area Safety.....	4
Electrical Safety.....	4
Personal Safety	4
Equipment Use and Care	5
Pre-Operation Inspection.....	5

Compact M40 Overview

Description	6
Standard Equipment.....	7
System Components	8

Specific Safety Information

Compact M40 Safety	8
--------------------------	---

Operating Instructions

Placement	9
Routing the Camera	9
Inspection Overview	9
Pipe Guides.....	9

CS6x Versa Docking System

Mounting the Monitor.....	10
Removing the Monitor	10
System Cable Removal	11

Maintenance and Support

Cleaning	12
Maintaining Components.....	12
Storage	12
Support.....	12
Service and Repair.....	12
Disposal.....	12

Introduction

The warnings, cautions, and instructions discussed in this manual cannot cover all possible conditions and situations that may occur. It must be understood by the operator that common sense and caution are factors which cannot be built into this product, but must be supplied by the operator.

Regulatory Statements

CE The EC Declaration of Conformity (890-011-320.10) will accompany this manual as a separate booklet when required.

FCC This device complies with Part 15 of FCC rules. Operation is subject to the following two conditions: (1) This device may not cause harmful interference, and (2) this device must accept any interference received, including interference that may cause undesired operation.

Safety Symbols

In this manual and on the product, safety symbols and signal words are used to communicate important safety information. This section is provided to improve understanding of these signal words and symbols.



This is the safety alert symbol. It is used to alert you to potential injury hazards. Obey all safety messages that follow this symbol to avoid possible injury or death.

⚠ DANGER

DANGER indicates a hazardous situation which, if not avoided, will result in death or serious injury.

⚠ WARNING

WARNING indicates a hazardous situation which, if not avoided, could result in death or serious injury.

⚠ CAUTION

CAUTION indicates a hazardous situation which, if not avoided, could result in minor or moderate injury.

NOTICE NOTICE indicates information that relates to the protection of property.



This symbol means read the operator's manual carefully before using the equipment. The manual contains important information on the safe and proper operation of the equipment.



This symbol means always wear safety glasses with side shields or goggles when handling or using this equipment to reduce the risk of eye injury.



This symbol indicates the risk of electrical shock.

General Safety Rules

⚠ WARNING



Read all safety warnings and instructions. Failure to follow the warnings and instructions may result in electrical shock, fire, and/or serious injury.

SAVE THESE INSTRUCTIONS!

Work Area Safety

- **Keep your work area clean and well lit.** Cluttered or dark areas invite accidents.
- **Do not operate equipment in explosive atmospheres, such as in the presence of flammable liquids, gases, or dust.** Equipment can create sparks which may ignite the dust or fumes.
- **Keep children and bystanders away while operating equipment.** Distractions can cause you to lose control.

Electrical Safety

- **Avoid body contact with earthed or grounded surfaces such as pipes, radiators, ranges, and refrigerators.** There is an increased risk of electrical shock if your body is earthed or grounded.
- **Do not expose equipment to rain or wet conditions.** Water entering equipment will increase the risk of electrical shock.
- **Keep all electrical connections dry and off the ground.** Touching equipment or plugs with wet hands can increase the risk of electrical shock.
- **Do not abuse the cord.** Never use the cord for carrying, pulling, or unplugging the power tool. Keep cord away from heat, oil, sharp edges, and moving parts. Damaged or entangled cords increase the risk of electrical shock.
- **If operating equipment in a damp location is unavoidable, use a ground fault circuit interrupter (GFCI) protected supply.** Use of a GFCI reduces the risk of electrical shock.

Personal Safety

- **Stay alert, watch what you are doing, and use common sense when operating equipment.** Do not use equipment while you are tired or under the influence of drugs, alcohol, or medication. A moment of inattention while operating equipment may result in serious injury.
- **Dress properly.** Do not wear loose clothing or jewelry. Loose clothes, jewelry, and long hair can be caught in moving parts.
- **Practice good hygiene.** Use hot, soapy water to wash hands and other body parts exposed to drain contents after handling or using drain inspection equipment. To prevent contamination from toxic or infectious material, do not eat or smoke while operating or handling drain inspection equipment.
- **Always use appropriate personal protective equipment when handling and using equipment in drains.** Drains may contain chemicals, bacteria, and other substances that may be toxic, infectious, and cause burns or other issues. Appropriate personal protective equipment always includes safety glasses and may include a dust mask, hard hat, hearing protection, drain cleaning gloves or mitts, latex or rubber gloves, face shields, goggles, protective clothing, respirators, and steel toed, non-skid footwear.
- **If using drain cleaning equipment and drain inspection equipment at the same time, wear RIDGID drain cleaning gloves.** Never grasp the rotating drain cleaning cable with anything else, including other gloves or a rag which can become wrapped around the cable and cause hand injuries. Only wear latex or rubber gloves underneath RIDGID drain cleaner gloves. Do not use damaged drain cleaning gloves.

Equipment Use and Care

- **Do not force equipment.** Use the correct equipment for your application. The correct equipment does the job better and more safely.
- **Do not use equipment if the power switch does not turn it on and off.** Any equipment that cannot be controlled with the power switch is dangerous and must be repaired.
- **Disconnect the plug from the power source and/or the battery pack from the equipment before making adjustments, changing accessories, or storing.** Preventive safety measures reduce the risk of injury.
- **Store idle equipment out of the reach of children and do not allow persons unfamiliar with the equipment or these instructions to operate the equipment.** Equipment can be dangerous in the hands of untrained users.
- **Maintain equipment.** Check for misalignment or binding of moving parts, missing parts, breakage of parts, and any other condition that may affect the equipment's operation. If damaged, have the equipment repaired before use. Many accidents are caused by poorly maintained equipment.
- **Do not overreach.** Keep proper footing and balance at all times. This enables better control of the equipment in unexpected situations.
- **Use the equipment and accessories in accordance with these instructions, taking into account the working conditions and the work to be performed.** Use of the equipment for operations different from those intended can result in hazardous situations.
- **Use only accessories that are recommended by the manufacturer for your equipment.** Accessories that may be suitable for one piece of equipment may become hazardous when used with other equipment.
- **Keep handles dry, clean, and free from oil and grease.** Clean handles give better control of the equipment.
- **Carrying the system incorrectly can cause the monitor's docking handle to disengage from the docking system and may result in property damage and/or serious injury.** Do not carry the Compact M40 by the monitor's docking handle or its front handle.

Pre-Operation Inspection

⚠ WARNING



To reduce the risk of serious injury from electrical shock or other causes, and to prevent damage to your equipment, inspect all equipment and correct any problems before each use.

To inspect all equipment, follow these steps:

1. Power off your equipment.
2. Disconnect and inspect all cords, cables, and connectors for damage or modification.
3. Clean any dirt, oil, or other contamination from your equipment to ease inspection and to prevent it from slipping from your grip during transport or use.
4. Inspect your equipment for any broken, worn, missing, misaligned, or binding parts, or any other condition which might prevent safe, normal operation.
5. Refer to the instructions for all other equipment to inspect and make sure it is in good, usable condition.
6. Check your work area for the following:
 - Adequate lighting.
 - The presence of flammable liquids, vapors, or dust that may ignite. If present, do not work in area until sources have been identified and corrected. The equipment is not explosion proof. Electrical connections can cause sparks.
 - A clear, level, stable, and dry place for the operator. Do not use the equipment while standing in water.
7. Examine the job to be done and determine the correct equipment for the task.
8. Observe the work area and erect barriers as necessary to keep bystanders away.

See additional product specific safety information and warnings starting on page 8.

Compact M40 Overview



Description

The RIDGID® SeeSnake® Compact M40 camera reel offers fast, easy setup and can take on the most diverse and demanding inspection conditions. The Compact M40 features a self-leveling camera at the end of a moderately stiff cable that offers a good compromise between stiffness and the ability to navigate through turns.

The Flexmitter® sonde helps locate points of interest in the pipe. Flexmitter sondes have long, powerful antennas capable of putting out a signal strong enough to pinpoint the camera's location underground, while still preserving its flexibility through turns.

All SeeSnake monitors can connect to the Compact M40. Pair it with a SeeSnake CSx™ series Wi-Fi enabled monitor to deliver professional multimedia reports to your customers quickly and easily.

The CS6x Versa is specifically designed to mount on the Compact M40's docking system for viewing ease, quick setup, and effortless transport.

TruSense™ Technology Description

TruSense technology establishes a two-way communication link between the camera head and a connected CSx series Wi-Fi enabled monitor. Advanced on-camera sensors convey valuable information about the in-pipe environment.

Included TruSense Sensors

TiltSense™

The TiltSense inclinometer measures the camera's degree of tilt and displays it on a CSx series Wi-Fi enabled monitor, giving you a useful indicator of the camera's angle as it lays inside the pipe.

HDR Image Sensor

The high dynamic range (HDR) image sensor expands the camera's dynamic range, allowing a greater ratio of bright and dark areas to be displayed in the same image at the same time without reducing visibility. The result is superior clarity and detail, allowing you to quickly and easily identify problem areas.

Specifications	
Weight	9.8 kg [22 lb]
Dimensions	
Length	626 mm [25 in]
Depth	360 mm [14 in]
Height	429 mm [16 in]
Drum diameter	432 mm [17 in]
TruSense Camera	
Type	Self-Leveling
Length	26 mm [1 in]* 37 mm [1.5 in]**
Diameter	25 mm [1 in]
Resolution	640 × 480 pixels
Sonde	
Type	FleXmitter®
Frequency	512 Hz
Distance Measurement	
Type	TruSense Counter
Data Communication	Two-Way
Push Cable	
Length	40 m [131 ft]
Diameter	9.1 mm [0.36 in]
Fiberglass core diameter	3.5 mm [0.14 in]
Minimum bend radius	76 mm [3 in]

Specifications	
Pipe Capacity §	38 mm to 203 mm [1.5 in to 8 in]
System Cable Length	3 m [10 ft]
Operating Environment	
Temperature †	-10°C to 50°C [14°F to 122°F]
Storage temperature	-10°C to 70°C [14°F to 158°F]
Ingress protection (without monitor)	IP×6
Relative humidity	5 to 95 percent
Altitude	4,000 m [13,123 ft]
Camera depth rating	Waterproof to 100 m [328.1 ft]
* Measured from lens to spring.	
** Measured from lens to end of threads.	
§ Actual pipe capacity depends on pipe conditions.	
‡ While the camera can function in extreme temperatures, some image quality changes may occur.	

Standard Equipment

- SeeSnake Compact M40
- Docking System
- Operator's Manual
- Pipe Guide Kit
- Spanner Wrench

System Components

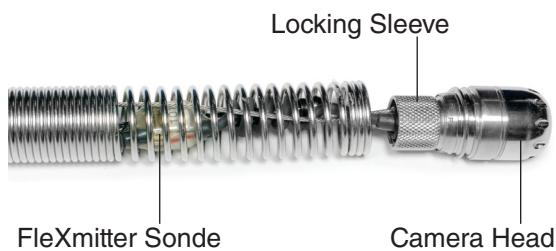

Specific Safety Information

⚠ WARNING



This section contains important safety information that is specific to the Compact M40. Read these precautions carefully before using the equipment to reduce the risk of electrical shock, fire, and/or serious injury.

SAVE ALL WARNINGS AND INSTRUCTIONS FOR FUTURE REFERENCE!

Compact M40 Safety

- Read and understand this manual, the digital reporting monitor's manual, and the instructions for any other equipment you are using before operating the equipment. Failure to follow all instructions may result in property damage and/or serious injury. Keep this manual with the equipment for future use.
- Operating the equipment while in water increases the risk of electrical shock. Do not operate the system if operator or equipment are standing in water.
- The equipment is not designed to provide high voltage protection and isolation. Do not use where a danger of high voltage contact is present.
- To prevent damage to the equipment and to decrease the risk of injury, do not expose the equipment to mechanical shocks. Exposure to mechanical shocks can damage equipment and increase the risk of serious injury.
- Always use appropriate personal protective equipment when handling and using equipment in drains. Wear appropriate protective equipment such as latex or rubber gloves, goggles, face shields, and respirators when inspecting drains that might contain hazardous chemicals or bacteria. Always wear eye protection to protect against dirt and other foreign objects.

Operating Instructions

Placement

Set up your SeeSnake system near the pipe entrance so you can manipulate the push cable while viewing the monitor. Make sure that the drum can spin freely. Placing the reel where the drum cannot spin freely may result in over-winding the cable, which may result in property damage and/or serious injury.



Routing the Camera

If the camera is inside the drum, you must route the camera through the push cable guides. The push cable and camera head should be threaded through all three guides.

1. Press the tab toward the outer edge of the outermost push guide to lock open the clip and free the camera spring
2. Reach inside the drum and find the camera.
3. Insert the camera through the inner push cable guide and then through the two outer push cable guides.
4. Return the spring clip to the operation position to secure the spring and prevent the push cable from retracting back into the drum.

Operation Position



Locked Open

Only lock open the spring clip when you are routing the camera. Keep the spring clip in the operation position during normal use.

Inspection Overview

To perform a pipe inspection, connect any SeeSnake monitor to the reel, power on the system, push the push cable through the pipe, and observe the display.

For advanced inspection options, such as capturing media, locating the sonde, tracing the push cable, and delivering reports, refer to the manual that comes with your monitor.

Connecting to the Monitor

Connect the system cable to the monitor by aligning the connector guide pin with the socket and pushing the connector straight in.

NOTICE Only twist the outer locking sleeve. Never bend or twist the connector.

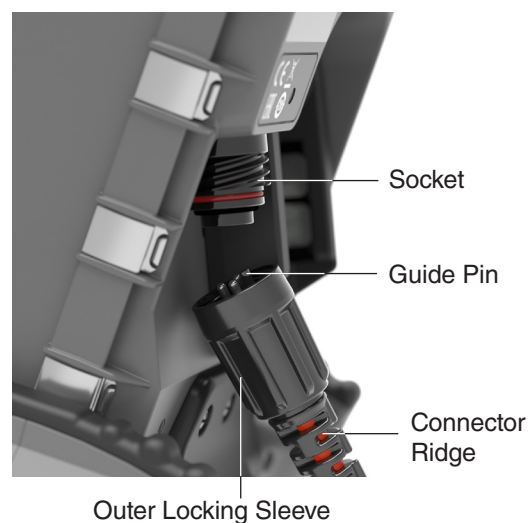

Retrieving the Camera

Pull the push cable back out of the pipe with slow, steady force and feed small lengths back into the drum. Wipe the push cable with a paper towel or rag as you retrieve it.

NOTICE Do not exert excessive force or pull at sharp angles. Feeding longer lengths or forcing the push cable may cause it to loop, kink, or break.

Pipe Guides

Pipe guides center the camera in the pipe, improve picture quality, and help keep the lens clear. Use pipe guides when possible to reduce wear and tear on the camera system.

CS6x Versa Docking System

⚠ WARNING

Do not carry the Compact M40 by the monitor's mounting frame or kickstand. Doing so can cause the monitor to disengage from the docking system and may result in property damage and/or serious injury.

Mounting the Monitor

1. Turn the docking joints on sides of the kickstand so that the openings point down.

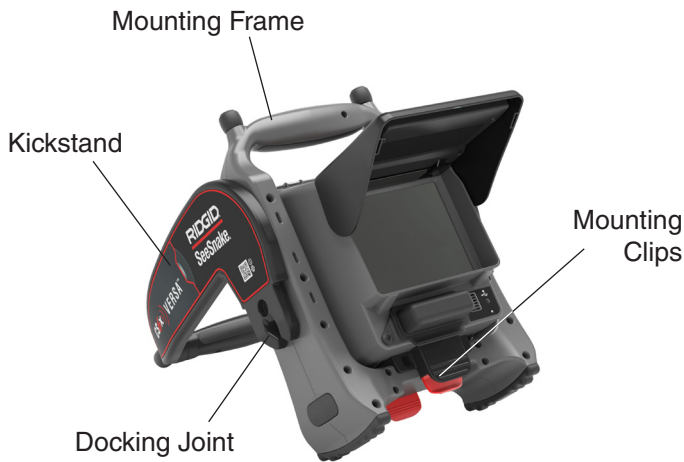

2. Center the CS6x Versa over the docking fins and align the docking joints with the joint sockets.

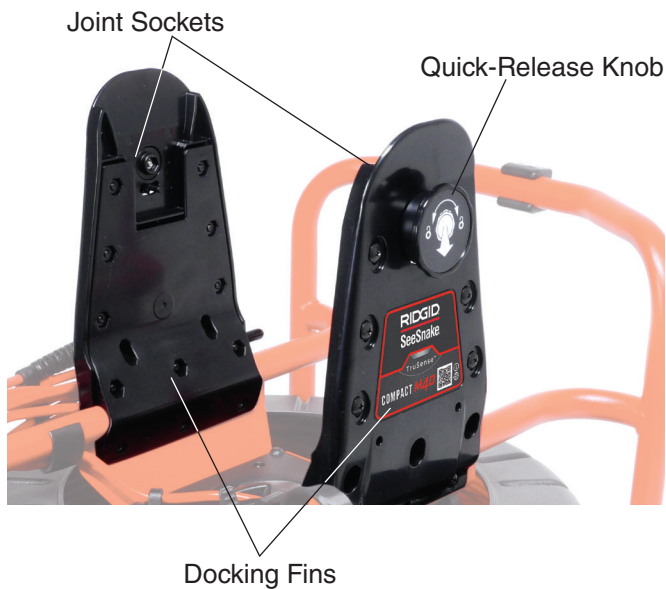

3. Firmly push the monitor down into the docking system until you feel the monitor lock into place.

Removing the Monitor

1. Place the Compact M40 so you can grasp both quick-release knobs.
2. Pull both knobs out and away from the docking fins. In the same motion as pulling the knobs out, turn the knobs together in either direction to disengage the locks.

Note: The locks are disengaged when the yellow indicator labels are visible under the knobs.
3. Grip the docking handle and pull the digital reporting monitor straight up.

System Cable Removal

1. Disconnect the system cable from the reporting monitor and remove the monitor from the docking system.
2. Unwrap the system cable from the cable wraps.
3. Pop the frame cable anchor off the frame and unhook the system cable from the frame hook.

Cable Anchor

Frame Hook

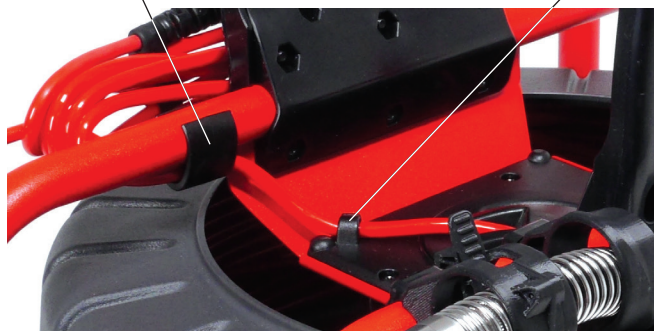

4. Turn the slip-ring dial counter-clockwise to the unlocked position **⓪**.
5. Pull straight out.

NOTICE Do not touch the contact pins inside the slip-ring dial. Stressing the contact pins can cause them to break.

Broken Contact Pin

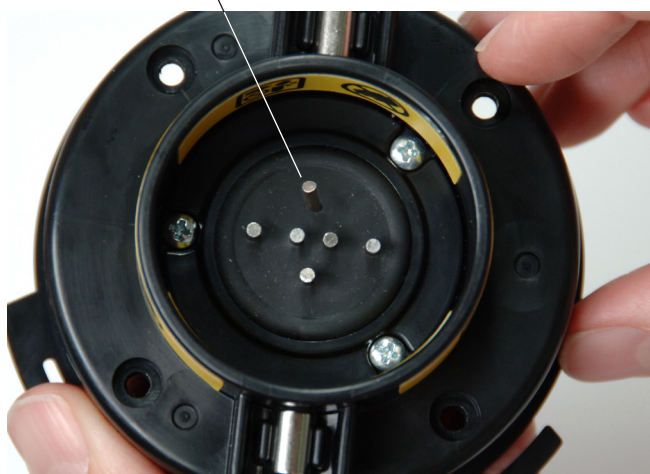

System Cable Installation

To install the system cable, follow these steps:

1. Align the arrow on the slip-ring dial with the unlock symbol **⓪** on the frame and insert the slip-ring dial into the slip-ring cavity.
2. Turn the slip-ring dial to the locked position **Ⓢ**.

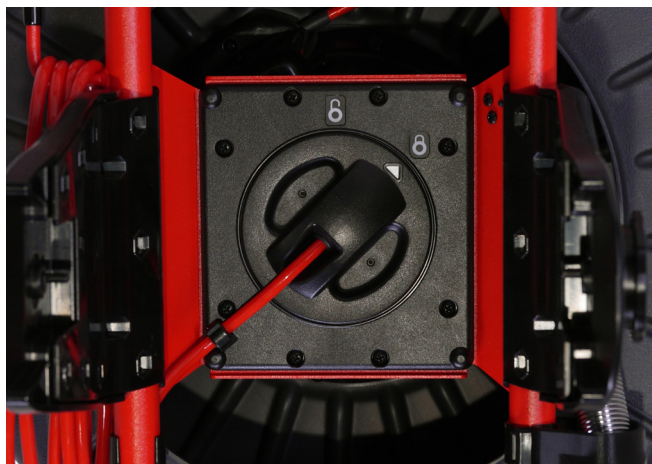

3. Hook the system cable into the frame hook and snap the cable anchor onto the frame.
4. Wrap the system cable around the cable wraps.

Maintenance and Support

Cleaning

Clean your system with rags and a soft nylon brush. If desired, a mild detergent or disinfectant can be used. Do not use solvents or high pressure water to clean any part of the system.

Maintaining Components

Camera Head

Scratches on the camera have a minimal effect on its performance. Do not use scraping tools or sand the camera to remove scratches.

Push Cable

Run a rag over the push cable and visually inspect it for cuts and abrasions while pushing it back into the drum. Replace or repair the push cable if the outer jacket is cut or abraded.

Storage

The Compact M40 must be stored in a dry, secure area between -10°C and 70°C [14°F and 158°F]. Store your equipment in a locked area out of the reach of children and people unfamiliar with its purpose.

Support

For support and additional information about using your system, visit support.seesnake.com/compact-m40/.

Service and Repair

Improper service or repair can cause the camera reel to be unsafe to operate.

Service and repair of the camera reel must be performed at a RIDGID Independent Authorized Service Center. To find your nearest service center or for any service or repair questions:

- Contact your local RIDGID distributor.
- Visit RIDGID.com.
- Contact Ridge Tool Company Technical Service Department at rtctechservices@emerson.com or, in the USA and Canada, call 1-800-519-3456.

Disposal

Parts of your system contain valuable materials that can be recycled. There are companies that specialize in recycling that may be found locally. Dispose of the components in compliance with all applicable regulations. Contact your local waste management authority for more information.



EC Countries: Do not dispose of electrical equipment with household waste!

According to the European Guideline 2012/19/EU for Waste Electrical and Electronic Equipment and its implementation into national legislation, electrical equipment that is no longer usable must be collected separately and disposed of in an environmentally correct manner.

Battery Disposal

EC Countries: Defective or used batteries must be recycled according to the guideline 2006/66/EEC.

WWW.RIDGID.COM

Ridge Tool Company
400 Clark Street
Elyria, Ohio 44035-6001
USA

1-800-474-3443

Ridge Tool Europe NV (RIDGID)
Ondernemerslaan 5428
3800 Sint-Truiden
Belgium

+32 (0)11 598 620

© 2019 Ridge Tool Company. All rights reserved.

Every effort has been made to ensure that the information in this manual is accurate. Ridge Tool Company and its affiliates reserve the right to change the specifications of the hardware, software, or both as described in this manual without notice. Visit www.RIDGID.com for current updates and supplemental information pertaining to this product. Due to product development, the photos and other presentations specified in this manual may differ from the actual product.

RIDGID and the RIDGID logo are trademarks of Ridge Tool Company, registered in the USA and other countries. All other registered and unregistered trademarks and logos mentioned herein are the property of their respective owners. Mention of third-party products is for informational purposes only and constitutes neither an endorsement nor a recommendation.

Printed in USA
999-998-438.10

2019/07/01
744-021-0096-00-0A

RIDGID

EMERSON