

JONES STEPHENS REPAIR PARTS



FAUCET REPAIR

TOILET REPAIR

**TUB & SHOWER
REPAIR**

PRODUCT CATALOG



Table of Contents

- Toilet Repair4**
- Tank Levers 4
- 2" Flappers..... 6
- 3" Flappers..... 6
- Tank Balls 7
- Flush & Fill Valves..... 7
- Bolts & Gaskets 9
- Mounting Hardware 11
- Accessories 12

- Faucet Repair 13**
- Single Handle Cartridges..... 13
- Two & Three Handle Stems 16
- Repair Kits 22
- Faucet Handles 23
- Faucet Seats..... 25
- Gaskets..... 25
- Seals & Grease..... 26
- Aerators & Faucet End Components 26
- Spray Heads & Hoses..... 27
- Faceplates & Trim Kits 27
- Mounting Hardware 28
- Easy Connect Tees 28

- Sink & Lavatory Repair 29**
- Stoppers..... 29
- Strainers 30
- Faucet Hole Covers 30

- Tub/Shower Repair 31**
- Waste & Overflow Trim 31
- Tub Spouts..... 32
- Shower Accessories 33
- Shower Heads..... 33

- Valves & Pumps..... 34**
- Gaskets & Packing 34
- Garden Hose Parts & Accessories 34
- HVAC Parts 34
- Pumps..... 34

- Stem/Cartridge Index..... 35**

JONES STEPHENS | REPAIR PARTS

If it's broke, fix it with our line of repair parts! Complimenting an already robust category of specialties and repair, Jones Stephens offers hundreds of high-quality plumbing repair parts in a carded, retail ready package. The category includes high demand faucet and toilet repair parts, as well as tub and shower parts – all manufactured to fit most brands.

Repair parts identification can sometimes be a tricky task! We've eliminated the guess work by adding several tools throughout this catalog, but our world class customer service team is always available to lend a hand if you need additional assistance. Using our innovative technology we're able to quickly identify the repair part(s) you're looking for. Give us a call today at 800-355-6637 or email us at parts@jonesstephens.com and we'll find the right part for you.



HIGH QUALITY



RELIABLE SERVICE



TRUSTED BRAND

MERCHANDISING SOLUTIONS

Pre-Planogrammed Options Include:

- Faucet Repair
- Kitchen Repair
- Toilet Repair
- Tub/Shower Repair
- Plumbing Housewares
- Stems

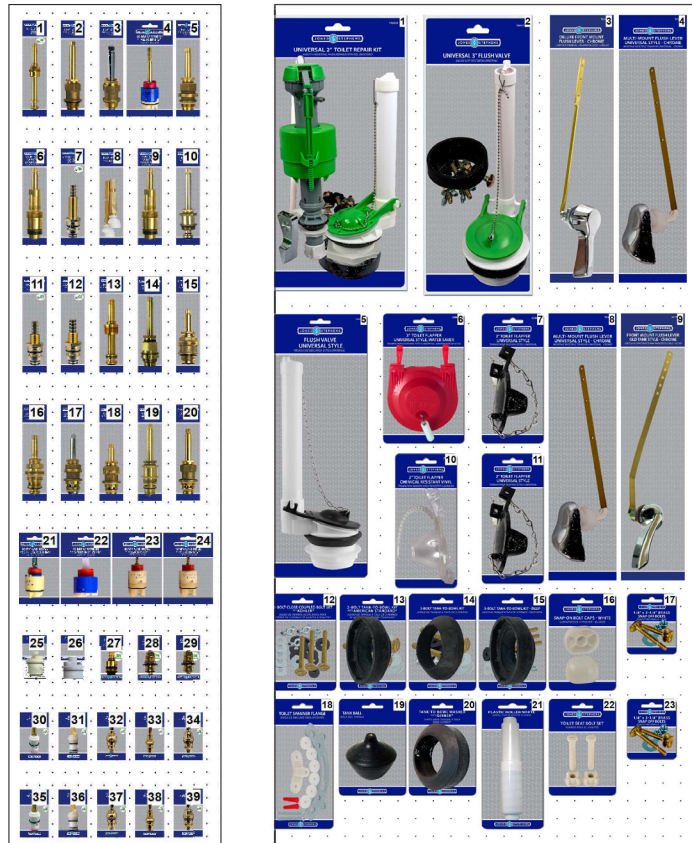

Contact your local Jones Stephens sales representative to order today!

TANK LEVERS

TANK TRIP LEVER FITS AMERICAN STANDARD®

- Chrome Plated metal lever
- 5" brass arm with chain clip
- Plastic spud and nut
- Front mount lever
- Fits American Standard® Glenwall™ 2093, Lexington™ 2006/2007 and Yorkville™ 2128/2130 toilet tanks
- Carded



PART NO.	DESCRIPTION	CTN/MSTR
T01023	5" Arm, Chrome Plated, Front Mount	6/48

TANK TRIP LEVER FITS AMERICAN STANDARD®, 28° ARM

- Chrome Plated Plastic Lever
- 8" plastic arm at 28° angle for corner mount applications
- Plastic spud & Nut
- Cut-Off arm at 4" and 6" lengths
- Angle mount lever
- Fits American Standard® and many other angle-mount toilets
- Carded



PART NO.	DESCRIPTION	CTN/MSTR
T01048	8" 28°, Chrome Plated, Angle Mount	6/48

TANK TRIP LEVER FITS AMERICAN STANDARD®, 45° ARM

- Chrome Plated plastic lever
- 6" 45° plastic arm with cut-off tab at 4"
- Plastic spud and nut
- Corner mount lever
- Fits American Standard® and others with 45° corner mount
- Carded



PART NO.	DESCRIPTION	CTN/MSTR
T01042L	6" 45° Arm, Chrome Plated, Corner Mount	6/72

MODERN STYLE TANK TRIP LEVER, FITS AMERICAN STANDARD® AND OTHERS

- 8" flat brass arm can be bent to fit most applications and angles
- Plastic spud and nut
- Fits most front mount and curved-front mount applications
- Modern lever design
- Carded



PART NO.	DESCRIPTION	CTN/MSTR
T01024	8" Arm, Chrome Plated, Front or Curve Mount	6/72
T01402	8" Arm, Brushed Nickel, Front or Curve Mount	6/72
T01401	8" Arm, White, Front or Curve Mount	6/72

TANK TRIP LEVER FITS BRIGGS®

- White plastic lever
- 8" angled plastic arm
- Plastic spud and nut
- Fits most front mount and curved-front mount applications
- Replaces #B357102 and #BRI4420
- Fits Briggs® toilet tank models: 4130, 4430, 4433, 4434, 4435, 4438, 4440, 4441, 4443, 4443L, 4444 and 4445
- Carded



PART NO.	DESCRIPTION	CTN/MSTR
T01335	8" Arm, White, Front or Curve Mount	1/6

TANK TRIP LEVER FITS ELJER® SIDE MOUNT

- Chrome Plated metal lever
- 9" brass arm
- Plastic spud and nut
- Side mount lever
- Fits Eljer® toilet tanks
- Carded



PART NO.	DESCRIPTION	CTN/MSTR
T01020L	8" Arm, Chrome Plated, Side Mount	6/48

TANK TRIP LEVER FITS KOHLER® SIDE MOUNT

- Chrome Plated metal lever
- 8" plastic arm
- Plastic spud and nut
- Side mount lever
- Fits Kohler® Wellworth™ and Waterguard/Lite™ toilet tanks
- Carded



PART NO.	DESCRIPTION	CTN/MSTR
T01016L	8" Arm, Chrome Plated, Side Mount	6/48

TANK TRIP LEVER FITS MANSFIELD®

- Chrome Plated metal lever
- 10" brass arm
- Plastic spud and nut
- Front mount lever
- Fits Mansfield® and other brands where long arm is necessary
- Carded



PART NO.	DESCRIPTION	CTN/MSTR
T01072L	10" Arm, Chrome Plated, Front Mount	6/48

**TANK TRIP LEVER FITS TOTO®
SIDE MOUNT**

- 8" straight brass arm
- Plastic spud and nut
- Side mount lever
- Carded



PART NO.	DESCRIPTION	CTN/MSTR
T01027	8" Straight Arm, Chrome Plated, Side Mount, Replaces #THU004	6/48
T01083	8" Straight Arm, Brushed Nickel, Side Mount, Replaces #PLU004	6/48

**TANK TRIP LEVER FITS TOTO®
SIDE MOUNT**

- 8" offset brass arm
- Plastic spud and nut
- Side mount lever
- Carded



PART NO.	DESCRIPTION	CTN/MSTR
T01028	8" Offset Arm, Chrome Plated, Side Mount, Replaces #THU068	6/48
T018BN	8" Offset Arm, Chrome Plated, Side Mount, Replaces #PLU068	6/48

**TANK TRIP LEVER FITS TOTO®
SIDE MOUNT**

- 10" bent brass arm
- Plastic spud and nut
- Side mount lever
- Carded



PART NO.	DESCRIPTION	CTN/MSTR
T01026	10" Bent Arm, Chrome Plated, Side Mount, Replaces #THU061	6/48
T01084	10" Bent Arm, Brushed Nickel, Side Mount, Replaces #PLU061	6/48

8-WAY UNIVERSAL TANK LEVER

- 8" arm
- Fits all toilet styles, including front, angle or side mount
- Works on left or right side of tank
- Side mount can have horizontal or vertical handle position
- High impact plastic will resist breaking and corrosion
- Contemporary lever design will match virtually any décor
- Easy to install
- No need to bend the arm
- Works with 2" or 3" style flush valves as well as canister style flush mechanisms
- Fits virtually all brands of toilets
- Carded



PART NO.	DESCRIPTION	CTN/MSTR
T01420	8" Arm, Chrome Plated, Front, Angle and Side Mount	6/72
T01421	8" Arm, White, Front, Angle and Side Mount	6/72
T01422	8" Arm, Brushed Nickel, Front, Angle and Side Mount	6/72

TANK TRIP LEVER WITH PLASTIC CUT-TO-LENGTH ARM

- 8" plastic arm
- Plastic spud and nut
- Use as 8" arm or use cut-off tabs at 4" or 6" to fit shorter applications
- Fits most front mount applications
- Carded



PART CODE	DESCRIPTION	CTN/MSTR
T01025	8" Cut-to-Length Arm, Chrome Plated, Front Mount	6/48
T01047	8" Cut-to-Length Arm, White, Front Mount	6/72

TANK TRIP LEVER

- 8" brass arm
- Metal spud and nut
- Fits most front mount installations
- Arm can be bent to clear tank or other internal components
- Heavy duty construction
- Carded



PART CODE	DESCRIPTION	CTN/MSTR
T01001L	8" Arm, Chrome Plated, Front Mount	6/48
T0107BN	8" Arm, Brushed Nickel, Front Mount	6/48
T0107RB	8" Arm, Oil Rubbed Bronze, Front Mount	6/48

TANK TRIP LEVER

- 8" brass arm
- Metal spud and nut
- Fits most front mount installations
- Arm can be bent to clear tank or other internal components
- Heavy duty construction
- Carded



PART CODE	DESCRIPTION	CTN/MSTR
T01022	8" Arm, Chrome Plated, Front Mount	6/48
T0105BN	8" Arm, Brushed Nickel, Front Mount	6/48
T0105RB	8" Arm, Oil Rubbed Bronze, Front Mount	6/48
T0105WB	8" Arm, Matte Black, Front Mount	6/48

TANK TRIP LEVER

- 10" flat brass arm can be bent to fit most applications and angles
- Metal spud and nut
- Fits most front mount and curved-front mount applications
- Extra long arm will work in older models with large tanks
- Carded



PART NO.	DESCRIPTION	CTN/MSTR
T01009	10" Arm, Chrome Plated, Front or Curve Mount	1/6
T0109BN	10" Arm, Brushed Nickel, Front or Curve Mount	6/48
T0109RB	10" Arm, Oil Rubbed Bronze, Front or Curve Mount	6/48

2" FLAPPERS

2" BLACK RUBBER TOILET FLAPPER

- For 2" flush valves
- Replaces Korky® Plus™ style flapper
- Includes stainless steel chain
- Rubber construction
- Less trunnion to use with current style plastic flush valves with ears
- Carded



PART NO.	DESCRIPTION	CTN/MSTR
C04007	2" Black Rubber Toilet Flapper	6/36

2" BLUE VINYL TOILET FLAPPER

- For 2" flush valves
- Replaces Coast® style flappers
- Includes stainless steel chain
- Vinyl construction for excellent chemical resistance
- Less trunnion to use with current style plastic flush valves with ears
- C04504 is carded; C04014 is carton quantity only



PART NO.	DESCRIPTION	CTN/MSTR
C04504	2" Blue Vinyl Toilet Flapper, Carded	6/36
C04014	2" Blue Vinyl Toilet Flapper, Carton of 100	100/2800

2" RED TWO-WAY TOILET FLAPPER

- For 2" flush valves
- Replaces Korky® Plus™ style flapper
- Includes stainless steel chain
- TPR construction for excellent chemical resistance
- With trunnion to cover overflow tube to be used in place of old style tank balls
- Remove trunnion to use with current style plastic flush valves with ears
- Carded



PART NO.	DESCRIPTION	CTN/MSTR
C04006	2" Red Two-Way Toilet Flapper	6/36

2" CLEAR VINYL TOILET FLAPPER

- For 2" flush valves
- Clear
- Includes vinyl lift strap
- Vinyl construction for excellent chemical resistance
- Less trunnion to use with current style plastic flush valves with ears
- Carded



PART NO.	DESCRIPTION	CTN/MSTR
FT02080	2" Clear Vinyl Toilet Flapper	3/72

2" RED TWO-WAY ADJUSTABLE TOILET FLAPPER

- For 2" flush valves
- Water saver adjustments - turn lower bulb for different flush rates
- Includes stainless steel chain with guard to prevent chain from catching under the flapper
- TPR construction for excellent chemical resistance
- With trunnion to go over overflow tube to be used in place of old style tank balls
- Remove trunnion to use with current style plastic flush valves with ears
- Carded



PART NO.	DESCRIPTION	CTN/MSTR
C04050	2" Red Two-Way Adjustable Toilet Flapper	1/12

3" FLAPPERS

3" FLAPPER FITS AMERICAN STANDARD CADET™ TOILETS

- Fits 3" Cadet™ 3 toilets
- Replaces American Standard™ #738920-0070A
- Hard plastic with silicone rubber seal disc
- Stainless Steel beaded lift chain with grommets
- Compatible with American Standard™ model numbers 4027.016, 4021.016 and 4019.016 using the white flush valve
- Compatible with American Standard Cadet™ 3 one-piece toilets models 2403012, 2403500, 2403800 and 2403850
- Carded



PART NO.	DESCRIPTION	CTN/MSTR
C04003	3" Flapper fits American Standard Cadet™ Toilets	6/24

3" FLAPPER FITS ALL TOTO® TOILETS

- Replaces all 3" Toto® flappers
- Replaces THU138S, THU175S, THU331S, THU140S, THU299S, THU253S, THU277S, THU347S, THU275S, THU332S, THU369S & THU499S
- Hard plastic frame with TPR body
- Stainless steel chain and grommet
- Resists chlorine and other chemicals commonly found in water
- Complete crossover and installation instructions available on packaging
- Carded



PART NO.	DESCRIPTION	CTN/MSTR
C04009	3" Universal Flapper Fits Toto® Toilets	1/10

3" RED TOILET FLAPPER FITS TOTO® G-MAX®

- For 3" flush valves
- Fits Toto® G-Max® style toilets
- Includes stainless steel chain
- Replaces Toto® #THU140S
- TPR construction for excellent chemical resistance
- Carded



PART NO.	DESCRIPTION	CTN/MSTR
C04001	3" Red Toilet Flapper fits TOTO® G-Max®	6/36

3" BLUE TOILET FLAPPER FITS TOTO® POWER GRAVITY®

- For 3" flush valves
- Fits Toto® Power Gravity® style toilets
- Replaces Toto® #THU175S
- Includes stainless steel chain
- TPR construction for excellent chemical resistance
- Carded



PART NO.	DESCRIPTION	CTN/MSTR
C04500	3" Blue Toilet Flapper fits TOTO® Power Gravity®	6/36

3" RED ADJUSTABLE TOILET FLAPPER

- For 3" flush valves
- Water saver adjustments - turn lower bulb for different flush rates
- Includes stainless steel chain with guard to prevent chain from catching under the flapper
- TPR construction for excellent chemical resistance
- Less trunnion to use with current style plastic flush valves with ears
- Carded



PART NO.	DESCRIPTION	CTN/MSTR
C04051	3" Red Adjustable Toilet Flapper	1/6

TANK BALLS

SCREW-ON OR SNAP-ON SEAT DISC FITS AMERICAN STANDARD®

- Fits all styles of American Standard® actuation units
- Use with supplied spud for screw-on or without the spud for snap-on applications
- Treated rubber to withstand chlorine commonly found in water
- 3" diameter
- Replaces American Standard® #047250-0070A & 047089-0070A
- Carded



PART NO.	DESCRIPTION	CTN/MSTR
C04625A	Screw-On or Snap-On Seat Disc fits American Standard®	6/72

FIT-ALL RUBBER TANK BALL

- Universal style
- Fits most popular lift-rod style flush valves
- Brass threaded socket to receive lower lift rod
- Tapered pattern for positive seal on most brands of toilets
- Rubber
- Carded



PART NO.	DESCRIPTION	CTN/MSTR
C04022	Fit-All Rubber Tank Ball	1/12

FLUSH & FILL VALVES

COMPLETE TOILET REPAIR KIT FOR TOILETS WITH 2" FLUSH VALVE

- For 2" flush valves
- Quiet integral float style fill valve with adjustable water height control
- Complete kit includes flush valve, flapper, chain, locknut, washer, sponge rubber tank-to-bowl gasket and three sets of brass tank-to-bowl bolts
- 5/16" x 3" bolt sets include all washers, nuts and gaskets
- 8" overflow tube
- Carded



PART NO.	DESCRIPTION	CTN/MSTR
C05250	Complete Toilet Repair Kit for Toilets with 2" Flush Valve	3/12

2" PLASTIC FLUSH VALVE AND RUBBER FLAPPER

- Fits most conventional two-piece toilets with 2 in flush valves
- Made of non-corrosive plastic
- Includes rubber flapper with stainless steel chain
- Will replace brass flush valves
- 8" overflow tube
- Douglas style
- With washer and locknut
- Carded



PART NO.	DESCRIPTION	CTN/MSTR
C05070	2" Plastic Flush Valve and Rubber Flapper	6/72

3" PLASTIC FLUSH VALVE OVERFLOW TUBE, FLAPPER, GASKET, AND TANK TO BOWL BOLT SET

- Fits all conventional 2-piece toilets with 3" flush valves
- Includes flush valve, flapper, stainless steel chain, locknut, washer, sponge rubber tank-to-bowl gasket and three sets of brass tank-to-bowl bolts
- Overflow tube adjusts from 7" to 10-3/8"
- Water-saving hard plastic 3" flapper with silicone seal adjusts to match flow rates of most toilets
- 5/16" x 3" bolt sets include all washers, nuts and gaskets
- Includes 3" sponge rubber tank-to-bowl gasket
- Non-corrosive, chemical resistant, hard plastic construction



PART NO.	DESCRIPTION	CTN/MSTR
C05073A	3" Plastic Flush Valve	3/12

2" FLUSH VALVE FITS KOHLER® LITE STYLE TWO-PIECE TOILETS

- Fits 2" Kohler® Lite style two-piece toilets
- Replaces #84665, #85159, #87373, #1003068, #1004808, #1007489, #1022551 and #1042831
- Includes 2" flapper that replaces #GP85160
- Flapper includes float on the beaded chain that can be adjusted to use less water during flush cycle
- 8" overflow tube
- With washer and locknut
- Carded



PART NO.	DESCRIPTION	CTN/MSTR
C05075	2" Flush Valve fits Kohler® Lite Style Two-Piece Toilets	1/6

FLUSH VALVE FITS MANSFIELD® 211 CANNISTER STYLE

- Replaces Mansfield® #211
- Will also replace an older #210 style flush valve
- 1.6 GPF (gallons per flush)
- Complete with seal, top stop, spud gasket and spud locknut
- Loop for flush lever to pass through the top or lower loop for lift chain
- Works with any 2" toilet
- Retrofit flapper style flush valve
- Carded



PART NO.	DESCRIPTION	CTN/MSTR
T02068	Flush Valve fits Mansfield® 211 Canister Style	6/24

FLUSH VALVE GASKETS FIT AMERICAN STANDARD® CHAMPION™ CANNISTER STYLE

- Larger washer replaces American Standard® Champion 4™ and Eljer® Titan 4™ flush valve seals
- Smaller washer replaces American Standard® Champion 3™ flush valve seal
- Treated rubber to withstand chlorine commonly found in water
- Carded

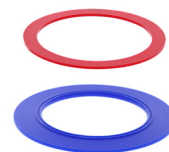

PART NO.	DESCRIPTION	CTN/MSTR
C05088	Flush Valve Gaskets fit American Standard® Champion™ Cannister Style	6/144

FLUSH VALVE GASKET FITS KOHLER® CANNISTER STYLE

- Fits either yellow or red Kohler® AquaPiston™, Class 5™ and Class 6™ style canister flush valves
- Replaces Kohler® #GP1059291
- Treated rubber to withstand chlorine commonly found in water
- Original part may be either red or yellow
- Carded



PART NO.	DESCRIPTION	CTN/MSTR
C05089	Flush Valve Gasket fits Kohler® Cannister Style	6/144

FLUSH VALVE SEAL FITS MANSFIELD® 210/211

- Flush Valve Seal for Mansfield lift up flush valves #210 and #212
- Original Mansfield parts
- Replaces Mansfield® #630-0031
- TPR material for excellent chemical resistance
- Snaps into groove on bottom of flush valve
- Carded



PART NO.	DESCRIPTION	CTN/MSTR
T02065L	Flush Valve Seal fits Mansfield® 210/211	6/72

ANTI-SIPHON BALLCOCK ASSEMBLY FITS KOHLER® RIALTO® ONE-PIECE TOILETS

- Ballcock/fill-valve
- Fits Kohler® Rialto® one-piece toilets
- Complete with fill valve, 8" float rod, bowl refill assembly, vinyl refill tube, shank washer, locknut, slip nut, cone washer and friction ring
- Adjustment screw to raise or lower the float to regulate how much water fills the tank
- Plastic for trouble-free performance in a wet environment
- Carded



PART NO.	DESCRIPTION	CTN/MSTR
T02080	Anti-Siphon Ballcock Assembly fits Kohler® Rialto® One-Piece Toilets	1/6

ANTI-SIPHON BALLCOCK ASSEMBLY FITS KOHLER® ONE-PIECE TOILETS

- Ballcock/fill-valve
- 1B1-X fits Kohler®, American Standard®, Briggs®, Crane®, Eljer®, Norris® and Universal Rundle® one-piece toilets
- Complete with fill valve, 8" float rod, bowl refill outlet, vinyl refill tube, shank washer, locknut, slip nut, cone washer and friction ring
- Adjustment screw to raise or lower the float to regulate how much water fills the tank
- Plastic for trouble-free performance in a wet environment
- Carded



PART NO.	DESCRIPTION	CTN/MSTR
T02081	Anti-Siphon Ballcock Assembly fits Kohler® One-Piece Toilets	1/6

BOLTS & GASKETS

CLOSET SPUD WASHER

- Fits 1-1/4" closet spuds
- Seals flush valve tailpiece to closet spud for leak-free performance
- Black rubber
- 1-1/2" ID x 2-7/16" OD x 1/2" high
- Top-hat (flanged) shape
- Carded



PART NO.	DESCRIPTION	CTN/MSTR
C27301	1-1/4" Closet Spud Washer	6/72
C27302	1-1/2" Closet Spud Washer	6/72

TANK TO BOWL GASKET, UNIVERSAL

- Universal to fit most 2" toilet tank to bowl installations
- 3.375" OD x 2.25" ID x .625" Thick beveled sponge rubber
- Repair and prevent leaks between the toilet tank and the bowl
- Carded



PART NO.	DESCRIPTION	CTN/MSTR
C03300L	2-1/4" ID x 3-3/8" OD x 11/16" Thick Tank to Bowl Gasket	6/72

TANK TO BOWL GASKET FITS 2" AMERICAN STANDARD®

- Fits most American Standard®, Crane® and Kohler® toilets with 2" flush valve
- Recessed sponge rubber tank-to-bowl gasket
- 2-1/8" ID x 3-1/2" OD x 1-1/4" thick
- Seals toilet tank to bowl
- Carded



PART NO.	DESCRIPTION	CTN/MSTR
C03303L	2-1/8" ID x 3-1/2" OD x 1-1/4" Thick Tank to Bowl Gasket fits American Standard®	6/48

TANK TO BOWL SPONGE GASKET FITS 3" AMERICAN STANDARD®

- Replaces tank to bowl gasket on American Standard®, Glacier Bay™, and other 3" Flush Valves
- 4.75" OD x 3.25" ID x 1.188" Thick sponge rubber with .75" recess.
- Recessed to fit over locknut of flush valve
- Carded



PART NO.	DESCRIPTION	CTN/MSTR
C03898	3" Tank to Bowl Sponge Gasket fits American Standard®	6/72

TANK TO BOWL GASKET FITS GERBER®

- Fits most Gerber® toilets with 2" flush valve
- Solid sponge rubber tank-to-bowl gasket
- 2-1/8" ID x 3-1/4" OD x 1-3/16" thick
- Seals toilet tank to bowl
- Carded



PART NO.	DESCRIPTION	CTN/MSTR
C03305L	2-1/8" ID x 3-1/4" OD x 1-3/16" Thick Tank to Bowl Gasket fits Gerber®	6/72

TANK TO BOWL SPONGE GASKET, 3" UNIVERSAL

- Universal tank to bowl gasket for 3" flush valves
- 4.438" OD x 3.0" ID x 1.188" Thick sponge rubber with .5" recess
- Recessed to fit over locknut of flush valve
- Carded



PART NO.	DESCRIPTION	CTN/MSTR
C03277	3" Tank to Bowl Sponge Gasket	6/48

TANK TO BOWL WASHER KIT FITS KOHLER®

- Replaces Kohler® GP52050 gaskets
- Complete set for a 3-bolt installation
- Use with C03280SS or C03899 3-pc tank to bowl bolt sets
- Carded



PART NO.	DESCRIPTION	CTN/MSTR
C03281L	Tank to Bowl Washer Kit fits Kohler® 3-Bolt Toilets	6/72

TANK TO BOWL BOLT KIT

- Fits most toilets with 2" flush valve
- Sponge rubber tank-to-bowl (close coupled) gasket
- Gasket is 1/2" thick to fit most applications
- Includes two solid brass close-coupled bolt sets
- Includes washers, plated steel screws and plated steel nuts for complete assembly
- Carded



PART NO.	DESCRIPTION	CTN/MSTR
C03201	5/16" x 3" Tank to Bowl Bolt Kit with Fit-All Gasket and Two Bolts	6/48

TANK TO BOWL BOLT KIT FITS AMERICAN STANDARD®

- Fits most American Standard® and Crane® style toilets with 2" flush valve
- Recessed sponge rubber tank-to-bowl (close coupled) gasket
- Includes solid brass close-coupled bolt sets
- Includes washers, plated steel screws and plated steel nuts for complete assembly
- Carded



PART NO.	DESCRIPTION	CTN/MSTR
C03220	5/16" x 3" Tank to Bowl Bolt Kit fits American Standard® with Two Bolts	6/48
C03273	5/16" x 3" Tank to Bowl Bolt Kit fits American Standard® with Three Bolts	6/48

SNAP-OFF SOLID BRASS CLOSET BOLTS

- Used to attach toilet to closet flange in the floor
- 1/4" x 2-1/4" solid brass bolts
- Nickel plated steel nuts and washers
- Captive top washer for easy installation
- Snap-off slot 1/2" from top of bolt to remove excess bolt for better fit of the cap
- Pair
- Carded



PART NO.	DESCRIPTION	CTN/MSTR
C02045L	1/4" x 2-1/4" Snap-Off Solid Brass Closet Bolts	6/144

EXTRA-HEAVY TANK TO BOWL SET

- For attaching a toilet tank to the toilet bowl
- Includes 3 complete sets for 2 and 3-bolt installations
- Heavy 5/16" x 3" solid brass bolts with 7/8" extra-wide slotted head
- Cloth inserted rubber washers for strength and durability
- Stainless Steel round washers for corrosion resistance
- Solid brass nuts
- Carded



PART NO.	DESCRIPTION	CTN/MSTR
C03899	Extra-Heavy Solid Brass Tank to Bowl 3-Bolt Set	6/72

PREMIUM SNAP-OFF STYLE STAINLESS STEEL CLOSET BOLTS

- For attaching toilet to floor flange
- Premium stainless steel bolts for superior strength and corrosion resistance
- 1/4" x 2-1/4" stainless steel break-off bolts with retainers to hold bolts in place during toilet installation
- Premium stainless steel washers and hex nuts
- Pair
- Carded



PART NO.	DESCRIPTION	CTN/MSTR
C02421SS	1/4" x 2-1/4" Snap-Off Style Closet Bolts with Retainers	12/144
C02990SS	1/4" x 3-1/2" Snap-Off Style Closet Bolts with Retainers	12/72
C02423SS	5/16" x 2-1/4" Snap-Off Style Closet Bolts with Retainers	12/144
C02424SS	5/16" x 3-1/2" Snap-Off Style Closet Bolts with Retainers	12/72

PREMIUM SNAP-OFF STYLE STAINLESS STEEL CLOSET BOLTS AND SCREW SET

- For attaching toilet to floor flange or securing toilet to wood floor
- Premium stainless steel bolts and screws for superior strength and corrosion resistance
- 1/4" x 2-1/4" stainless steel break-off bolts with retainers to hold bolts in place during toilet installation
- 1/4" x 2-1/2" Stainless steel closet screws with stainless steel dome nut
- Premium Stainless steel washers and hex nuts
- Includes pair of screws and pair of bolts
- Carded



PART NO.	DESCRIPTION	CTN/MSTR
C02313SS	1/4" x 2-1/4" Stainless Steel Snap-Off Style Closet Bolts with Retainers and 1/4" x 2-1/2" Closet Screws	12/72

PREMIUM STAINLESS STEEL TANK TO BOWL BOLT SET

- For attaching a toilet tank to the toilet bowl
- Includes 3 complete sets for 2 and 3-bolt installations
- Heavy 5/16" x 3" solid premium stainless steel bolts with slotted head
- Rubber washers, premium stainless steel round washers and hex nuts
- Carded



PART NO.	DESCRIPTION	CTN/MSTR
C03280SS	5/16" x 3" Premium Stainless Steel Tank to Bowl Bolt Set, Pack of 3	6/48

TOILET BOLT CAPS WITH BRASS BOLTS

- For attaching toilet to floor flange and covering the bolts after installation
- 1/4" x 2-1/4" brass break-off bolts with retainers to hold bolts in place during toilet installation
- Plastic bushing goes over the bolt and attaches to the cap for a positive hold
- Caps screw into bolts for positive lock-down
- No Putty or caulk needed
- White caps
- Carded



PART NO.	DESCRIPTION	CTN/MSTR
C02151	White Toilet Bolt Caps with 1/4" x 2-1/4" Brass Break-Off Bolts	6/144

OVAL CLOSET BOLT CAPS

- White plastic
- Snap-on type
- Oval shape
- Covers oval shaped washers on closet bolts
- Hi-Impact plastic will avoid breaking or cracking
- Carded



PART NO.	DESCRIPTION	CTN/MSTR
C02100L	White Oval Closet Bolt Caps, Pair	6/72

REPLACEMENT HARDWARE TOP MOUNT TOILET SEAT HINGES

- White plastic nuts and bolts
- Fits most top mount toilet seats
- Slotted bolt top for easy installation
- Deep nut with ridges for easy installation
- 7/16" x 2-1/2" overall length
- Carded



PART NO.	DESCRIPTION	CTN/MSTR
C200PHB	Replacement Hardware Top Mount Toilet Seat Hinges	6/48

MOUNTING HARDWARE

CLOSET SPANNER FLANGE KIT

- Repair broken closet flanges without replacing the entire flange
- Heavy nickel plated steel construction
- With slots for closet bolts or screws
- With anchors, washers and screws
- Use anchors and screws to attach to floor or sub-floor
- Permanent repair that will hold toilet tightly
- Carded



PART NO.	DESCRIPTION	CTN/MSTR
C87200	Closet Spanner Flange Kit	6/36

URINAL FLANGE REPAIR KIT

- Used to fix broken urinal flanges at the wall without removing old flange
- No need to go back into the wall and replace plumbing pipes
- Includes screws, anchors and spacers to add additional support
- Comes with foam rubber gasket and adhesive to re-mount urinal for leak-free performance
- Complete instructions included
- Bagged



PART NO.	DESCRIPTION	CTN/MSTR
C88000	Urinal Flange Repair Kit	1/12

BRASS BALLCOCK COUPLING NUT

- To attach riser or water line to toilet fill valve (ballcock)
- 1/2" center hole for 1/2" or 3/8" OD risers
- Solid brass nut for long life and corrosion resistance
- Includes rubber cone washer for positive seal and leak proof installation
- Brass friction ring to prevent washer from warping when tightening nut
- Carded



PART NO.	DESCRIPTION	CTN/MSTR
C05083	7/8" x 1/2" Brass Ballcock Coupling Nut	6/144

CARRIER NUTS AND WASHER SET

- Fits most brands of wall-mounted toilet and urinal carriers
- Aluminum for strength and durability
- 3/4" height and 1-3/4" flange diameter
- White fiber washers - 3/4" ID x 1-3/4" OD
- Includes 4 nuts and washers
- Bagged



PART NO.	DESCRIPTION	CTN/MSTR
C56100	Carrier Nuts and Washer Set	25/100

ACCESSORIES

WHITE PLASTIC FIT-ALL TOILET TISSUE ROLLER

- White
- High-impact plastic for long life
- Spring loaded for easy paper changing
- 5/8" ends to fit most posts and most toilet tissue holders
- Easy to install
- Carded



PART NO.	DESCRIPTION	CTN/MSTR
B10196	White Plastic Fit-All Toilet Tissue Roller	6/72

FIT-ALL URINAL SCREEN WITH DEODORIZER

- Prevents clogging of urinal drain
- White plastic
- Fragrance bar masks odors
- Large size fits most urinals
- 7" long and 7" wide
- 1-1/2" tall non-replaceable fragrance block
- Bagged with header card



PART NO.	DESCRIPTION	CTN/MSTR
S95250	Fit-All Urinal Screen with Deodorizer	6/36

SINGLE HANDLE CARTRIDGES

PRESSURE BALANCED TUB/SHOWER CARTRIDGE FITS DELTA® MONITOR®

- Fits Delta® 1300 and 1400 Monitor™ and Pressure Balance tub and shower faucets
- Replaces #RP19804
- For single handle faucets
- Pressure balanced to maintain constant pressure between the hot and cold sides
- Temperature limit stop that can be set to avoid scalding
- Complete with bottom seals and center washer for leak free installation
- Plastic body with blue bottom; brass stem
- 4" overall length
- Carded



PART NO.	DESCRIPTION	CTN/MSTR
C25447	Pressure Balanced Tub/Shower Cartridge fits Delta® Monitor®	4/24
C25463	Pressure Balanced Tub/Shower Cartridge fits Delta® Monitor®, Pack of 3	2/12

PRESSURE BALANCED TUB/SHOWER CARTRIDGE FITS DELTA® MULTICHOICE®

- Fits Delta® 13 and 14 series MultiChoice™ tub and shower faucets
- Replaces #RP46074
- For single handle faucets
- Pressure balanced to maintain constant pressure between the hot and cold sides
- Temperature limit stop that can be set to avoid scalding
- Complete with bottom seals and center washer for leak free installation
- Plastic body with white bottom; brass stem
- 4-3/8" overall length
- Carded



PART NO.	DESCRIPTION	CTN/MSTR
C25451	Pressure Balanced Tub/Shower Cartridge fits Delta® Multichoice®	4/24
C25464	Pressure Balanced Tub/Shower Cartridge fits Delta® Multichoice®, Pack of 3	2/12

PRESSURE BALANCED TUB/SHOWER CARTRIDGE FITS DELTA®

- Fits Delta® 17 series MultiChoice™ tub and shower faucets
- Replaces #RP46463
- For single handle faucets
- Pressure balanced to maintain constant pressure between the hot and cold sides
- Temperature limit stop that can be set to avoid scalding
- Complete with seat assembly
- Plastic body with stainless steel bottom plate; brass stem
- 3-1/4" overall length; 1-9/16" bottom diameter
- Carded



PART NO.	DESCRIPTION	CTN/MSTR
C25449	Pressure Balanced Tub/Shower Cartridge fits Delta	4/24

CERAMIC CARTRIDGE FITS DELTA®

- Fits Delta® lavatory and kitchen faucets
- Replaces #RP50587
- For single handle faucets with set screws
- Hi-Impact plastic body construction
- Temperature limit stop that can be set to avoid scalding
- Ceramic Diamond-Seal® control mechanism for long lasting leak-free performance
- 2-11/16" overall length; 1-7/16" bottom diameter
- Carded



PART NO.	DESCRIPTION	CTN/MSTR
C25450	Ceramic Cartridge fits Delta®	4/24

TUB/SHOWER CARTRIDGE FITS DELTA® MONITOR® AND SCALD-GUARD®

- Fits Delta® 1600 Monitor® and Scald-Guard® series tub and shower faucets
- Replaces #RP1991
- Celcon body; brass stem
- Temperature limit stop that can be set to avoid scalding
- Complete with two seats
- Stainless steel bottom plate
- Rectangular shaped broach
- 2" overall length
- Carded



PART NO.	DESCRIPTION	CTN/MSTR
C25456	Tub/Shower Cartridge fits Delta® Monitor® and Scald-Guard®	4/48

STAINLESS STEEL BALL FITS DELTA®/ DELEX® AND PEERLESS® 70 STYLE FAUCETS

- Fits Delta®/Delex® and Peerless® 70 ball style faucets
- Replaces #RP70
- Stainless steel construction
- Can be used with lever handles that use set screw style handles
- Flat area on stem for positive seat of handle set screw
- Use together with heart-shaped cam
- 1-1/2" ball and 2" stem
- Also fits most imported ball-style faucets
- Carded



PART NO.	DESCRIPTION	CTN/MSTR
C25433	Stainless Steel Ball fits Delta®/Delex® and Peerless® 70 Style Faucets	4/72

STAINLESS STEEL BALL FITS DELTA®/ DELEX® AND PEERLESS® 212 STYLE FAUCETS

- Fits Delta®/Delex® and Peerless® 212 ball style faucets
- Replaces #RP212
- Stainless steel construction
- Can be used with knob handles that use screw-in handles with index buttons
- Diamond shaped stem with female thread for handle screw
- Use together with slotted cam
- Also fits most imported ball-style faucets
- Carded



PART NO.	DESCRIPTION	CTN/MSTR
C25434	Stainless Steel Ball fits Delta®/Delex® and Peerless® 212 Style Faucets	4/72

SEATS & SPRINGS SET FITS DELTA®/ DELEX® AND PEERLESS®

- Fits Delta®/Delex® and Peerless® kitchen, lavatory, and tub and shower faucets
- Replaces #RP4993
- Includes seats and springs to fit old and new styles
- Includes: 2 New Style (Short) Seats and 2 New Style (Conical) Springs
- Includes: 2 Old Style (Long) Seats and 2 Old Style (Long) Springs
- TPR Seats
- Stainless Steel springs
- Also fits most imported ball-style faucets
- Carded



PART NO.	DESCRIPTION	CTN/MSTR
C25431	Seats & Springs Set fits Delta®/Delex® and Peerless® Faucets, 2 of Each	6/144
C25459	Seats & Springs Set fits Delta®/Delex® and Peerless® New Style Faucets, 25 of Each	4/48

DIVERTER FITS DELTA®/DELEX® AND PEERLESS®

- Fits Delta®/Delex® and Peerless® tub and shower faucets
- Replaces #RP5649
- Chrome plated finish
- Pull up to send water to shower head, push down to send water to tub
- Solid brass
- O-ring seal and TPR flapper for positive seal
- Carded



PART NO.	DESCRIPTION	CTN/MSTR
C25430	Chrome Plated Diverter fits Delta®/Delex® and Peerless® Tub/Shower Faucets	4/48

PRESSURE BALANCED TUB/SHOWER CARTRIDGE FITS GLACIER BAY® AND ZURN®

- Fits Zurn® and some Glacier Bay® tub and shower faucets
- Replaces Zurn® Z7300 Series
- For single handle faucets
- Plastic washerless body with ceramic controls, handle adapter with set-screw
- Pressure balanced to maintain constant pressure between the hot and cold sides
- Temperature limit stop that can be set to avoid scalding
- 3-7/16" overall length
- Carded



PART NO.	DESCRIPTION	CTN/MSTR
C07650	40MM (1-9/16") Pressure Balanced Tub/Shower Cartridge fits Glacier Bay® and Zurn®	6/144

PRESSURE BALANCED TUB/SHOWER CARTRIDGE FITS GLACIER BAY®

- Fits Glacier Bay® tub and shower faucets
- Also fits some imports
- For single handle faucets
- Plastic washerless body with ceramic controls
- Pressure balanced to maintain constant pressure between the hot and cold sides
- Temperature limit stop that can be set to avoid scalding
- 3-7/16" overall length
- Carded



PART NO.	DESCRIPTION	CTN/MSTR
C07655	40MM (1-9/16") Pressure Balanced Tub/Shower Cartridge fits Glacier Bay®	6/48

PRESSURE BALANCED TUB/SHOWER CARTRIDGE FITS GLACIER BAY®

- Fits Glacier Bay® tub and shower faucets
- Cut-off points on broach to cut-down stem for perfect handle clearance
- For single handle faucets
- Plastic washerless body with ceramic controls
- Pressure balanced to maintain constant pressure between the hot and cold sides
- Temperature limit stop that can be set to avoid scalding
- 5-1/4" overall length
- Carded



PART NO.	DESCRIPTION	CTN/MSTR
C07656	40MM (1-9/16") Pressure Balanced Tub/Shower Cartridge fits Glacier Bay®	6/48

TUB/SHOWER CARTRIDGE FITS MOEN® POSI-TEMP®

- Fits Moen® Posi-Temp® tub and shower faucets
- Replaces #1222
- For single handle faucets
- Plastic with lead free brass stem
- 4-1/8" overall length
- Includes installation tool and waterproof, non-toxic stem grease
- Carded



PART NO.	DESCRIPTION	CTN/MSTR
C1777TS	Tub/Shower Cartridge fits Moen® Posi-Temp®	6/72
C1777TSX5	Tub/Shower Cartridge fits Moen® Posi-Temp®, Pack of 5	4/36

BRASS CARTRIDGE FITS MOEN® MAGNUM

- Fits Moen® Chateau and Magnum faucets
- Replaces #1200
- For single handle faucets
- Solid lead free brass
- 4-3/16" overall length
- Includes installation tool & brass lock clip
- Carded



PART NO.	DESCRIPTION	CTN/MSTR
C1775TS	Brass Cartridge fits Moen® Magnum	6/72

CARTRIDGE FITS MOEN® MAGNUM

- Fits Moen® Chateau and Magnum faucets
- Replaces #1225
- For single handle faucets
- Plastic with lead free brass stem
- 4-3/16" overall length
- Includes installation tool and lock clip
- Carded



PART NO.	DESCRIPTION	CTN/MSTR
C1776TS	Cartridge fits Moen® Magnum	6/72
C1776TSX5	Cartridge fits Moen® Magnum, Pack of 5	4/36

BALANCING SPOOL FITS MOEN® MOENTROL®

- Fits Moen® Moentrol™ tub and shower faucets
- Replaces #1423
- For single handle faucets
- Solid brass
- Carded



PART NO.	DESCRIPTION	CTN/MSTR
C25481	Balancing Spool fits Moen® Moentrol® Tub/Shower Faucets	3/48

CERAMIC CARTRIDGE FITS MOEN® KITCHEN FAUCETS

- Fits Moen® Level 7175 & 7175CSL kitchen faucets
- Replaces #4000
- For single handle faucets
- Plastic body with ceramic discs
- 2-3/8" overall height, 1-5/16" diameter
- With bottom rubber seal
- Carded



PART NO.	DESCRIPTION	CTN/MSTR
C25476	Ceramic Cartridge fits Moen® Kitchen Faucets	3/36

PUSH-BUTTON DIVERTER ASSEMBLY FITS MOEN® CHATEAU AND LEGEND

- Fits Moen® Magnum® Chateau and Legend tub and shower faucets
- Replaces #1198
- For single handle faucets
- Solid brass
- Chrome plated finish on exposed parts
- 3" overall length
- Carded



PART NO.	DESCRIPTION	CTN/MSTR
C25482	Chrome Plated Push-Button Diverter Assembly fits Moen® Chateau and Legend Tub/Shower Valves	4/48

CARTRIDGE FITS VALLEY® AQUALINE™

- Fits Valley® Aqualine™ lavatory and kitchen faucets
- Replaces #V-6680
- For single handle faucets
- Plastic
- 2-5/16" overall length
- Carded



PART NO.	DESCRIPTION	CTN/MSTR
C1770CH	Cartridge fits Valley® Aqualine™	6/72

FLOW-MATIC™ TUB/SHOWER CARTRIDGE FITS PFISTER® AVANTE

- Fits Pfister® Avante and Flow-Matic™ tub and shower faucets
- Replaces #900-022
- For single handle faucets
- Solid brass body
- Complete with 4 installation screws and gasket
- 2-1/4" overall length
- Carded

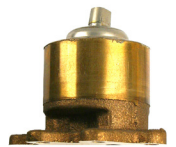

PART NO.	DESCRIPTION	CTN/MSTR
C07755	Flow-Matic™ Tub/Shower Cartridge fits Pfister® Avante	6/48

CARTRIDGE FITS ZURN®, SYMMONS®, JONES STEPHENS® AND AQUAPLUMB®

- Fits Symmons®, Zurn®, Jones Stephens® and AquaPlumb® faucets
- Also fits some imports
- For single handle faucets
- Plastic washerless body with ceramic controls
- Temperature limit stop that can be set to avoid scalding
- 2-5/8" overall length
- Carded



PART NO.	DESCRIPTION	CTN/MSTR
C07651	40MM (1-9/16") Cartridge fits Zurn®, Symmons®, Jones Stephens® and AquaPlumb®	6/144

TWO & THREE HANDLE STEMS

LAVATORY CERAMIC STEM FITS ALTMANS® AND SEARS®

- Fits Altmans® and Sears® lavatory faucets
- Lead free brass body with ceramic control
- 2-1/8" overall length
- Quarter turn
- Carded



PART NO.	DESCRIPTION	CTN/MSTR
C07632	Hot Lavatory Ceramic Stem fits Altmans® and Sears®	6/144
C07682	Cold Lavatory Ceramic Stem fits Altmans® and Sears®	6/144

CERAMIC STEM FITS ALTMANS® SIGMA

- Fits Altmans® Sigma lavatory and kitchen faucets
- Lead free brass body with ceramic control
- 2-5/8" overall length
- Quarter turn
- Carded



PART NO.	DESCRIPTION	CTN/MSTR
C07633	Hot Ceramic Stem fits Altmans® Sigma	6/144
C07683	Cold Ceramic Stem fits Altmans® Sigma	6/144

STEM FITS AMERICAN STANDARD® CADET

- Fits American Standard® Cadet faucets: Sink (4160 series) Lavatory (2350 Series) Bath (1800 Series)
- For hot or cold side of the faucet
- Lead free brass
- With Nu-Seal washer on bottom
- 1-11/16" overall length
- Carded



PART NO.	DESCRIPTION	CTN/MSTR
C07274	Hot or Cold Stem fits American Standard® Cadet	6/144

TUB/SHOWER STEM FITS AMERICAN STANDARD® COLONY™

- Fits American Standard® tub and shower faucets
- Replaces #50729-07
- For hot or cold side of the faucet
- Brass
- With bonnet, bibb washer, bibb screw, stainless steel wavy washer and packing washer
- 4-9/16" overall length
- Carded



PART NO.	DESCRIPTION	CTN/MSTR
C07324	Hot or Cold Tub/Shower Stem fits American Standard® Colony™	6/72

LAVATORY STEM FITS CRANE® DIAL-ESE

- Fits Crane® Dial-ese lavatory and sink faucets
- Replaces #FB8552, #FB8553, #FB8173 and #FB8172
- Lead free brass
- With bonnet, bottom seal and cork-style gasket
- 2-5/16" overall length
- Carded



PART NO.	DESCRIPTION	CTN/MSTR
C07411	Hot Lavatory Stem fits Crane® Dial-ese	6/144
C07412	Cold Lavatory Stem fits Crane® Dial-ese	6/144

WASHERLESS STEM FITS DELTA®/DELEX® AND PEERLESS®

- Fits Delta®/Delex® and Peerless® lavatory and kitchen faucets
- Replaces #RP1740 and #RP1745
- For hot or cold side of the faucet
- Celcon plastic
- For two and three handle washerless faucets
- Complete with a new style seat and spring
- Stainless steel bottom plate
- 1-13/16" overall length
- C25435 and C25461 are carded; C25466 is in reclosable clam box



PART NO.	DESCRIPTION	CTN/MSTR
C25435	Hot or Cold Washerless Stem fits Delta®/Delex® and Peerless®	6/72
C25461	Hot or Cold Washerless Stem fits Delta®/Delex® and Peerless®, 1 Pair	4/48
C25466	Hot or Cold Washerless Stem fits Delta®/Delex® and Peerless®, 5 Pack	4/32

BRASS STEM FITS DELTA®/DELEX® AND PEERLESS®

- Fits Delta®/Delex® and Peerless® faucets
- Replaces #RP25513
- For hot or cold side of the faucet
- Celcon body; brass stem
- For two and three handle faucets
- Includes stop insert allowing for use with knob and lever style handles
- Stainless steel bottom plate
- Complete with seat and spring
- 1-15/16" overall length
- C25448 is carded; C25467 is in reclosable clam box



PART NO.	DESCRIPTION	CTN/MSTR
C25448	Hot or Cold Brass Stem fits Delta®/Delex® and Peerless®	6/48
C25467	Hot or Cold Brass Stem fits Delta®/Delex® and Peerless®, 5 Pack	4/32

STEM EXTENSION FITS DELTA®/DELEX® AND PEERLESS®

- Fits Delta®/Delex® and Peerless® tub and shower faucets
- Replaces #RP18627
- For two handle faucets
- White celcon plastic
- Half-moon broach
- Includes extra-long handle screw to reach the stem
- Includes hex wrench for handle and flange set screws
- 3" overall length
- Carded



PART NO.	DESCRIPTION	CTN/MSTR
C25453	Stem Extension fits Delta®/Delex® and Peerless® Tub/ Shower Faucets	4/48

DIVERTER ASSEMBLY FITS DELTA®/DELEX® AND PEERLESS®

- Fits Delta®/Delex® and Peerless® kitchen faucets
- Replaces #RP320 and #RP63136
- For two handle faucets
- Diverts water to hand spray or spout
- Plastic body with brass center assembly
- Rubber seal for positive shut-off between functions
- Carded



PART NO.	DESCRIPTION	CTN/MSTR
C25457	Diverter Assembly fits Delta®/Delex® and Peerless® Kitchen Faucets	6/72

HOT OR COLD TUB/SHOWER STEM FITS GERBER®

- Fits Gerber® tub and shower faucets
- Replaces #98-674
- For hot or cold side of the faucet
- Brass
- With bonnet, bibb washer, bibb screw, cap gasket, packing washer and packing nut
- 5-7/16" overall length
- Carded



PART NO.	DESCRIPTION	CTN/MSTR
C07435	Hot or Cold Tub/Shower Stem fits Gerber®	6/72

CERAMIC STEM FITS GLACIER BAY®

- Fits Glacier Bay® lavatory and kitchen faucets
- Fits Dorset™ and Builder™ series faucets
- Plastic washerless body with ceramic controls and internal stop to prevent handle from spinning
- 1-15/16" overall length
- Quarter turn
- Carded



PART NO.	DESCRIPTION	CTN/MSTR
C07626	Hot Ceramic Stem fits Glacier Bay®	6/144
C07676	Cold Ceramic Stem fits Glacier Bay®	6/144

CERAMIC STEM FITS GLACIER BAY® AND AQUASOURCE

- Fits Glacier Bay® & AquaSource lavatory and kitchen faucets
- Fits faucets that use external stop that uses inside of the handle to prevent it from spinning
- Plastic washerless body with ceramic controls
- 2" overall length
- Quarter turn
- Carded



PART NO.	DESCRIPTION	CTN/MSTR
C07627	Hot Ceramic Stem fits Glacier Bay® and AquaSource	6/144
C07677	Cold Ceramic Stem fits Glacier Bay® and AquaSource	6/144

HOT OR COLD TUB/SHOWER STEM FITS HARCRAFT®

- Fits Harcraft® tub and shower faucets
- For hot or cold side of the faucet
- Brass
- With bonnet, bibb washer, bibb screw and cap gasket
- 4-9/16" overall length
- Carded



PART NO.	DESCRIPTION	CTN/MSTR
C07414	Hot or Cold Tub/Shower Stem fits Harcraft®	6/72

TUB/SHOWER CERAMIC STEM FITS HARDEN®

- Fits Harden® tub and shower faucets
- Cut-off points on broach to cut-down stem for perfect handle clearance
- Lead free brass body with ceramic control
- 4-5/8" overall length
- Quarter turn
- Carded



PART NO.	DESCRIPTION	CTN/MSTR
C07624	Hot Tub/Shower Ceramic Stem fits Harden®	6/72
C07674	Cold Tub/Shower Ceramic Stem fits Harden®	6/72

WIDESPREAD LAVATORY CERAMIC STEM FITS HARDEN®

- Fits Harden® widespread lavatory faucets
- Cut-off points on broach to cut-down stem for perfect handle clearance
- Lead free brass body with ceramic control
- 3-1/2" overall length
- Quarter turn
- Carded



PART NO.	DESCRIPTION	CTN/MSTR
C07625	Hot Widespread Lavatory Ceramic Stem fits Harden®	6/72
C07675	Cold Widespread Lavatory Ceramic Stem fits Harden®	6/72

LAVATORY CERAMIC STEM FITS JADO®

- Fits Jado® lavatory faucets
- Lead free brass body with ceramic control
- 2-1/8" overall length
- Quarter turn
- Carded



PART NO.	DESCRIPTION	CTN/MSTR
C07637	Hot Lavatory Ceramic Stem fits Jado®	6/144
C07687	Cold Lavatory Ceramic Stem fits Jado®	6/144

CERAMIC STEM FITS MOEN® LAVATORY FAUCETS

- Fits Moen® 8210 lavatory faucets
- Replaces #52000
- For two handle faucets
- Lead free brass body with ceramic disc
- 1-7/8" overall length
- Carded



PART NO.	DESCRIPTION	CTN/MSTR
C25479	Hot Ceramic Stem fits Moen® Lavatory Faucets	3/48
C25478	Cold Ceramic Stem fits Moen® Lavatory Faucets	3/48

STEM FITS MOEN® AND STANADYNE™

- Fits Moen® kitchen and lavatory faucets
- Replaces #1224 and #1248B
- For two handle faucets
- For hot or cold side of the faucet
- Washerless
- Plastic body with stainless steel interior
- 2-5/8" overall length
- Carded



PART NO.	DESCRIPTION	CTN/MSTR
C1765CH	Hot or Cold Stem fits Moen® and Stanadyne™	6/144

CERAMIC STEM FITS NEWPORT BRASS®

- Fits Newport Brass® lavatory and kitchen faucets
- Lead free brass body with ceramic control
- 2-5/8" overall length
- Quarter turn
- Carded



PART NO.	DESCRIPTION	CTN/MSTR
C07645	Hot Ceramic Stem fits Newport Brass®	6/144
C07695	Cold Ceramic Stem fits Newport Brass®	6/144

**HOT OR COLD TUB/SHOWER STEM FITS
PFISTER® CROWN IMPERIAL**

- Fits Pfister® tub and shower
- Replaces #910-013, 910-034, S10-013 and S10-034
- For hot or cold side of the faucet
- Brass
- With bonnet, bibb washer, bibb screw, cap gasket, packing washer and packing nut
- 4-5/16" overall length
- Carded



PART NO.	DESCRIPTION	CTN/MSTR
C07409	Hot or Cold Tub/Shower Stem fits Pfister® Crown Imperial	6/72

**DIVERTER TUB/SHOWER STEM FITS
PFISTER® CROWN IMPERIAL**

- Fits Pfister® tub and shower faucets
- Replaces #910-022 and S10-022
- For center diverter to send water to shower or tub spout
- Brass
- With bonnet, bibb washer, bibb screw, cap gasket, packing washer and packing nut
- 4-5/16" overall length
- Carded



PART NO.	DESCRIPTION	CTN/MSTR
C07410	Diverter Tub/Shower Stem fits Pfister® Crown Imperial	6/72

**HOT OR COLD TUB/SHOWER STEM FITS
PFISTER® BEAUX ART**

- Fits Pfister® tub and shower faucets
- Replaces #910-043
- For hot or cold side of the faucet
- Brass
- With bonnet, bibb washer, bibb screw, cap gasket, packing washer and packing nut
- 5-1/16" overall length
- Carded



PART NO.	DESCRIPTION	CTN/MSTR
C07453	Hot or Cold Tub/Shower Stem fits Pfister® Beaux Art	6/72

**DIVERTER TUB/SHOWER STEM FITS
PFISTER® BEAUX ART**

- Fits Pfister® tub and shower faucets
- Replaces #910-052
- For center diverter to send water up to shower or down to tub spout
- Brass
- With bonnet, bibb washer, bibb screw, cap gasket, packing washer and packing nut
- 4-5/16" overall length
- Carded



PART NO.	DESCRIPTION	CTN/MSTR
C07404	Diverter Tub/Shower Stem fits Pfister® Beaux Art	6/72

**HOT OR COLD TUB/SHOWER STEM FITS
PFISTER® MARQUIS AND VERVE**

- Fits Pfister® tub and shower faucets
- Replaces #910-374 and #S10-375
- For hot or cold side of the faucet
- Brass
- With bonnet, bibb washer, bibb screw, cap gasket, packing washer and packing nut
- 5-9/16" overall length
- Carded



PART NO.	DESCRIPTION	CTN/MSTR
C07461	Hot or Cold Tub/Shower Stem fits Pfister® Marquis and Verve	6/72

**DIVERTER TUB/SHOWER STEM FITS
PFISTER® MARQUIS AND VERVE**

- Fits Pfister® tub and shower faucets
- Replaces #910-385 and #S910-385
- For center diverter to send water to shower or tub spout
- Brass
- With bonnet, bibb washer, bibb screw, cap gasket, packing washer and packing nut
- 5-5/8" overall length
- Carded



PART NO.	DESCRIPTION	CTN/MSTR
C07462	Diverter Tub/Shower Stem fits Pfister® Marquis and Verve	6/72

HOT OR COLD WIDESPREAD STEM FITS PFISTER®

- Fits Pfister® lavatory and kitchen faucets
- Replaces #910-523 and #S10-522
- For hot or cold side of the faucet
- Lead free brass
- With bonnet, bibb washer, bibb screw and cap gasket
- 6" overall length
- Carded



PART NO.	DESCRIPTION	CTN/MSTR
C07487	Hot or Cold Widespread Stem fits Pfister®	6/72

HOT OR COLD TUB/SHOWER STEM FITS SAYCO® NEW STYLE

- Fits Sayco® tub and shower faucets
- Fits tub and shower faucet models 308 and T-308 (from 1968 to current)
- For hot or cold side of the faucet
- Brass
- With bonnet, bibb washer, bibb screw, cap gasket, packing washer and packing nut
- 4-11/16" overall length
- Carded



PART NO.	DESCRIPTION	CTN/MSTR
C07326	Hot or Cold Tub/Shower Stem fits Sayco® New Style	6/72

DIVERTER TUB/SHOWER STEM FITS SAYCO® NEW STYLE

- Fits Sayco® tub and shower faucets
- Fits tub and shower faucet models 308 and T-308 (from 1968 to current)
- For center diverter to send water to shower or tub spout
- Brass
- With bonnet, bibb washer, bibb screw, cap gasket, packing washer and packing nut
- 4-11/16" overall length
- Carded



PART NO.	DESCRIPTION	CTN/MSTR
C07417	Diverter Tub/Shower Stem fits Sayco® New Style	6/72

LAVATORY CERAMIC STEM FITS SPEAKMAN®

- Fits Speakman® lavatory faucets
- Lead free brass body with ceramic control
- 2-3/8" overall length
- Quarter turn
- Carded



PART NO.	DESCRIPTION	CTN/MSTR
C07641	Hot Lavatory Ceramic Stem fits Speakman®	6/144
C07691	Cold Lavatory Ceramic Stem fits Speakman®	6/144

HOT OR COLD TUB/SHOWER STEM FITS STERLING®

- Fits Sterling® tub and shower faucets
- Replaces #A1944
- For hot or cold side of the faucet
- Brass
- With bonnet, bibb washer, bibb screw, cap gasket, packing washer and packing nut
- 4-3/4" overall length
- Carded



PART NO.	DESCRIPTION	CTN/MSTR
C07308	Hot or Cold Tub/Shower Stem fits Sterling®	6/72

DIVERTER TUB/SHOWER STEM FITS STERLING®

- Fits Sterling® tub and shower faucets
- Replaces #A8106
- For center diverter to send water to shower or tub spout
- Brass
- With bonnet, bibb washer, bibb screw, cap gasket, packing washer and packing nut
- 4-11/16" overall length
- Carded



PART NO.	DESCRIPTION	CTN/MSTR
C07310	Diverter Tub/Shower Stem fits Sterling®	6/72

**HOT OR COLD WASHERLESS TUB/
SHOWER STEMS FITS STERLING®**

- Fits Sterling® tub and shower faucets
- Fits tub and shower faucet models 031, 032 and 033
- For hot or cold side of the faucet
- Brass
- With plastic bottom assembly, plastic seat assembly, seat, spring, O-ring seals and handle screw
- Includes two different lengths - short 3-9/16" overall length and long 4-1/4" overall length
- Carded



PART NO.	DESCRIPTION	CTN/MSTR
C07323	Hot or Cold Washerless Tub/Shower Stems fits Sterling®, Includes Short and Long Length	6/72

**HOT OR COLD WASHERLESS STEM
FITS VALLEY®**

- Fits Valley® lavatory and kitchen faucets
- For hot or cold side of the faucet
- Plastic
- Washerless
- 1-7/8" overall length
- Carded



PART NO.	DESCRIPTION	CTN/MSTR
C07229	Hot or Cold Washerless Stem fits Valley®	6/144

**HOT OR COLD WASHERLESS TUB/
SHOWER STEM FITS VALLEY®**

- Fits Valley® tub and shower faucets
- For hot or cold side of the faucet
- Plastic
- Washerless
- 2-1/2" overall length
- Carded



PART NO.	DESCRIPTION	CTN/MSTR
C07225	Hot or Cold Washerless Tub/Shower Stem fits Valley®	6/144

REPAIR KITS

**COMPLETE FAUCET REPAIR KIT FITS
DELTA®/DELEX® AND PEERLESS® BALL
STYLE FAUCETS**

- Fits Delta®/Delex® and Peerless® ball style faucets
- Replaces #RP3614
- Fits faucets with knob or lever handles
- Includes spout o-rings and 2 new style seats and springs
- Fits slotted and heart-shaped cam
- Includes wrench to remove set screw style handles
- Also fits most imported ball-style faucets
- Carded



PART NO.	DESCRIPTION	CTN/MSTR
C25429	Complete Faucet Repair Kit fits Delta®/Delex® and Peerless® Ball Style Faucets	6/72

**COMPLETE FAUCET REPAIR KIT FITS
DELTA®/DELEX® AND PEERLESS® 70
STYLE BALL FAUCET**

- Fits Delta®/Delex® and Peerless® 70 ball style faucets
- Replaces #RP3614 and #RP70
- Fits faucets with lever handles and set screws
- With 70 style stainless steel ball
- Includes spout o-rings and 2 new style seats and springs
- Heart-shaped cam
- Includes wrench to remove set screw style handles
- Also fits most imported ball-style faucets
- Carded



PART NO.	DESCRIPTION	CTN/MSTR
C25436	Complete Faucet Repair Kit fits Delta®/Delex® and Peerless® Ball Style Faucets	4/48

**COMPLETE FAUCET REPAIR KIT FITS
DELTA®/DELEX® AND PEERLESS® 212
STYLE BALL FAUCETS**

- Fits Delta®/Delex® and Peerless® 212 ball style faucets
- Replaces #RP3614 and #RP212
- Fits faucets with knob handles
- With 212 style stainless steel ball
- Includes spout o-rings and 2 new style seats and springs
- Slotted cam
- Includes wrench to remove set screw style handles
- Also fits most imported ball-style faucets
- Carded



PART NO.	DESCRIPTION	CTN/MSTR
C25437	Complete Faucet Repair Kit fits Delta®/Delex® and Peerless® Ball Style Faucets	4/48

COMPLETE FAUCET REPAIR KIT FITS DELTA®/DELEX® AND PEERLESS® TWO HANDLE FAUCETS

- Fits Delta®/Delex® and Peerless® lavatory and kitchen faucets
- Replaces #RP1740, #RP23498 and #RP4993
- For two handle faucets
- Includes 2 washerless 1740 style stems and 2 new style seats and springs
- Hot and Cold acrylic handles with index button and screws
- Carded



PART NO.	DESCRIPTION	CTN/MSTR
C25460	Complete Faucet Repair Kit fits Delta®/Delex® and Peerless® Two Handle Faucets	4/24

CAP ASSEMBLY FITS DELTA®/DELEX® AND PEERLESS®

- Fits Delta®/Delex® and Peerless® kitchen faucets
- Replaces #RP50
- Chrome plated finish
- Solid brass construction
- Includes nylon adjustment ring
- Replaces old style with grip ridges on bottom
- Also fits most imported ball-style faucets
- Carded



PART NO.	DESCRIPTION	CTN/MSTR
C25432	Chrome Plated Cap Assembly fits Delta®/Delex® and Peerless® Style Faucets	4/48

PEX COMPRESSION ADAPTER FITS DELTA® FAUCETS

- Fits Delta® lavatory and kitchen faucets
- Replaces #RP63263
- Also fits other lavatory and kitchen faucet brands
- Chrome plated brass
- Includes: 4 adapters and 4 rubber washers
- 2 adapters for 1/2" IPS to 3/8" compression; 2 adapters for 1/2" compression to 3/8" compression
- Lead free
- Carded



PART NO.	DESCRIPTION	CTN/MSTR
C25446	Chrome Plated 1/2" x 3/8" PEX Compression Adapter fits Delta® Faucets	6/48

CARTRIDGE REMOVAL TOOL FITS MOEN®

- Fits Moen® 1200, 1225 and 1222 style cartridges
- Replaces #104421
- For single handle faucets
- Chrome plated steel construction
- T-handle provides extra leverage for pulling or twisting
- Carded



PART NO.	DESCRIPTION	CTN/MSTR
C25503	Cartridge Removal Tool fits Moen® Cartridges	3/24

FAUCET HANDLE ADAPTER KIT FITS MOEN® CHATEAU

- Fits Moen® 7400 and 7600 series kitchen faucets
- Replaces #100429
- Used to replace old style lever handles
- Zinc die cast mount and plastic stem bushings
- Complete with handle screw, set screw and hex key
- Carded



PART NO.	DESCRIPTION	CTN/MSTR
C25491	Faucet Handle Adapter Kit fits Moen® Chateau Single Handle Kitchen Faucets	6/72

REPAIR KIT FITS MOEN® POSI-TEMP® CARTRIDGES

- Fits Moen® Posi-Temp® faucets
- Replaces #96914
- For single handle faucets
- Complete with (1) stainless steel lock clip, (2) cartridge side seals, (1) non-toxic stem grease packet and (5) o-rings
- Carded



PART NO.	DESCRIPTION	CTN/MSTR
C25471	Repair Kit fits Moen® Posi-Temp® Cartridges	6/144

REPAIR KIT FITS MOEN® BRASS OR PLASTIC CARTRIDGES

- Fits Moen® Posi-Temp®, Chateau and Magnum faucets
- Replaces #833, #1883 and #96914
- For single handle faucets
- Includes: (2) new style and (2) old style brass retainer clips for Magnum & Chateau and (2) stainless steel clips for Posi-Temp®
- Carded

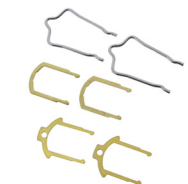

PART NO.	DESCRIPTION	CTN/MSTR
C25474	Repair Kit fits Moen® Brass or Plastic Cartridges	6/144

FAUCET HANDLES

SINGLE KNOB REPLACEMENT HANDLE FITS DELTA® LAVATORY

- Fits Delta® lavatory faucets
- Replaces #RP17449
- Crystal clear acrylic
- Complete with handle screw and index button
- Straight broach (handle attachment) to work on lavatory faucets
- Fits diamond-shaped stem with center broach
- Carded



PART NO.	DESCRIPTION	CTN/MSTR
C25441	Acrylic Single Knob Replacement Handle fits Delta® Lavatory Faucets	4/32

SINGLE KNOB REPLACEMENT HANDLE FITS DELTA® TUB/SHOWER

- Fits Delta® tub and shower faucets
- Replaces #RP17451 and #RP2391
- Crystal clear acrylic
- Complete with handle screw and index button
- Offset broach (handle attachment) to work with tub and shower faucets
- Fits diamond-shaped stem with center broach
- Carded



PART NO.	DESCRIPTION	CTN/MSTR
C25438	Acrylic Single Knob Replacement Handle fits Delta® Tub/ Shower Faucets	4/32

SINGLE KNOB REPLACEMENT HANDLE FITS DELTA® MONITOR® AND SCALD-GUARD®

- Fits Delta® Monitor® and Scald-Guard® series tub and shower faucets
- Replaces #H71
- Crystal clear acrylic
- Complete with handle screw and index button
- Broached to fit Monitor® Scald-Guard® style cartridges
- Carded



PART NO.	DESCRIPTION	CTN/MSTR
C25442	Acrylic Single Knob Replacement Handle fits Delta® Monitor® and Scald-Guard® Tub/Shower Faucets	4/32

SINGLE LEVER HANDLE FITS DELTA®/ DELEX® AND PEERLESS®

- Fits Delta®/Delex® and Peerless® 70 ball style lavatory and tub and shower faucets
- Replaces #RP90
- Chrome plated finish
- Includes set screw to attach to 70 style ball
- Shorter pattern to work with lavatory, commercial sink faucets and some tub and shower faucets
- Also fits most imported ball-style faucets
- ADA compliant
- Carded



PART NO.	DESCRIPTION	CTN/MSTR
C25439	Chrome Plated Lever Handle fits Delta®/Delex® and Peerless®	4/32

SINGLE LEVER REPLACEMENT HANDLE FITS DELTA®/DELEX® AND PEERLESS®

- Fits Delta®/Delex® and Peerless® 70 ball style kitchen faucets
- Replaces #RP2393
- Chrome plated finish
- Includes set screw to attach to 70 style ball
- Longer pattern
- Also fits most imported ball-style faucets
- ADA compliant
- Carded



PART NO.	DESCRIPTION	CTN/MSTR
C25440	Chrome Plated Single Lever Replacement Handle fits Delta®/Delex® and Peerless® Kitchen Faucets	4/32

SINGLE LEVER REPLACEMENT HANDLE FITS DELTA®

- Fits Delta® tub and shower faucets
- Replaces #RP17443
- Chrome plated finish
- Includes set screw to attach to top of stem
- ADA compliant
- Carded



PART NO.	DESCRIPTION	CTN/MSTR
C25443	Chrome Plated Single Lever Replacement Handle fits Delta® Tub/Shower Faucets	4/32

KNOB REPLACEMENT HANDLES FITS DELTA®/DELEX® AND PEERLESS

- Fits Delta®/Delex® and Peerless® lavatory and kitchen faucets
- Replaces #RP23498
- Crystal clear acrylic
- Complete with handle screws and index buttons
- Half-Moon shaped broach (handle attachment) to fit two handle style stems
- Also fits most imported faucets with half-moon shaped broach
- Carded



PART NO.	DESCRIPTION	CTN/MSTR
C25445	Acrylic Knob Replacement Handles fits Delta®/Delex® and Peerless, Pair	4/32

WIDESPREAD KNOB REPLACEMENT HANDLES FITS DELTA®/DELEX® AND PEERLESS, PAIR

- Fits Delta®/Delex® and Peerless® widespread lavatory and tub and shower faucets, and bidets
- Replaces #H41A
- Crystal clear acrylic
- Complete with handle screws and index buttons
- Half-Moon shaped broach (handle attachment) to fit two handle style stems
- Carded



PART NO.	DESCRIPTION	CTN/MSTR
C25444	Acrylic Widespread Knob Replacement Handles fits Delta®/Delex® and Peerless, Pair	4/32

SINGLE KNOB REPLACEMENT HANDLE FITS MOEN® CHATEAU

- Fits Moen® Chateau and Magnum lavatory faucets
- Replaces #96791
- For single handle faucets
- Crystal clear acrylic
- Short broach
- Complete with index button, handle screw and stem adapter ring
- 1-7/8" overall height
- Carded



PART NO.	DESCRIPTION	CTN/MSTR
H53032	Acrylic Single Knob Replacement Handle fits Moen® Chateau Lavatory Faucets	6/48
H54031	Acrylic Single Knob Replacement Handle with Deep Broach fits Moen® Chateau Tub/Shower Faucets	6/48

SINGLE KNOB REPLACEMENT HANDLE FITS MOEN® POSI-TEMP®

- Fits Moen® Posi-Temp® tub and shower faucets
- Replaces #100710
- For single handle faucets
- Crystal clear acrylic
- Long broach
- Complete with handle screw, index button and stem adapter ring
- 1-7/8" overall height
- Carded



PART NO.	DESCRIPTION	CTN/MSTR
H54033	Acrylic Single Knob Replacement Handle fits Moen® Posi-Temp® Tub/Shower Faucets	6/48

SINGLE LEVER REPLACEMENT HANDLE FITS MOEN® POSI-TEMP®

- Fits Moen® Chateau and Posi-Temp® tub and shower faucets
- Replaces #100224
- For single handle faucets
- Chrome plated zinc die cast construction
- Complete with handle screw, set screw and hex wrench
- 4-1/16" long, 2-1/8" diameter canopy
- Carded



PART NO.	DESCRIPTION	CTN/MSTR
H54039	Chrome Plated Single Lever Replacement Handle fits Moen® Posi-Temp® Tub/Shower Faucets, New Style	4/48

METAL TUB REPLACEMENT HANDLES FITS PFISTER® VERVE

- Fits Pfister® Verve tub and shower faucets
- Chrome plated die-cast
- Includes three index buttons so it can be used as a hot, cold or diverter handle
- Complete with handle screw
- Carded



PART NO.	DESCRIPTION	CTN/MSTR
H54045	Chrome Plated Metal Tub Replacement Handles fits Pfister® Verve	6/48

FAUCET SEATS

144 PIECE BRASS FAUCET SEAT ASSORTMENT

- 144 piece assortment includes 140 brass faucet seats and 4 monel faucet seats
- 36 different items
- Lead free for use with potable water
- For compression style bathroom, lavatory, kitchen, bar, laundry and tub shower faucets
- Brands include American Standard®, Arrowhead®, Central®, Crane®/Repcal™, Eljer®, Gerber®, Harcraft®, Indiana®, Kohler®, Milwaukee®, Pfister®, Savoy®, Sayco®, Speakman®, Sterling®, Streamway® and Union Brass®
- Recloseable compartmentalized box includes a descriptive lid insert with pictures showing sizes and thread types



PART NO.	DESCRIPTION	CTN/MSTR
C07110	144 Piece Brass Faucet Seat Assortment	1/10

FAUCET SEAT AND SPRING KIT FITS VALLEY® AQUALINE

- Fits Valley® Aqualine faucets
- For two-handle and single handle faucets
- Simple repair to fix leaking faucet
- Repairs lever and crystal handle faucets
- Includes two seats, two springs and two stiffeners
- Carded



PART NO.	DESCRIPTION	CTN/MSTR
C1760S	Faucet Seat and Spring Kit fits Valley® Aqualine Faucets	6/144

GASKETS

217 PIECE ASSORTED O-RING KIT

- 217 piece assortment
- Includes 14 different sizes of O-rings
- O-rings are made of low-swell Buna-N material, ideal for all plumbing applications
- All of the most common sizes found in stems, single handle cartridges and faucet spouts
- Includes 1/2 oz. container of non-toxic silicone plumber's grease in resealable tub
- Recloseable compartmentalized box includes a descriptive lid insert with size chart and full size pictures



PART NO.	DESCRIPTION	CTN/MSTR
O25201	217 Piece Assorted O-Ring Kit	1/20

KITCHEN SPOUT O-RINGS FITS DELTA® FAUCETS

- Fits Delta® kitchen faucets
- Replaces #RP25 and #RP2055
- Fits single handle and two handle spouts
- Complete 5 piece O-ring kit
- Self lubricating neoprene rubber
- Carded



PART NO.	DESCRIPTION	CTN/MSTR
C25458	Kitchen Spout O-Rings fits Delta® Faucets	6/144

160 PIECE ASSORTED BEVELED BIBB WASHER AND SCREW KIT

- 160 piece assortment
- Includes 6 sizes of beveled bibb washers and 3 sizes of brass bibb screws
- Washers include trade size 00, 0, 1/4L, 3/8R, 3/8L and 1/2
- Washers are made from the highest quality neoprene and are precision molded for long life
- Bibb screws 1/2" x 8-32, 1/2" x 10-24 and 1/2" x 10-32
- Recloseable compartmentalized box includes a descriptive lid insert



PART NO.	DESCRIPTION	CTN/MSTR
J40155	160 Piece Assorted Beveled Bibb Washer and Screw Kit	1/20

205 PIECE ASSORTED FLAT BIBB WASHER AND SCREW KIT

- 205 piece assortment
- Includes 7 sizes of flat bibb washers and 3 sizes of brass bibb screws
- Washers include trade size 00, 0, 1/4, 1/4L, 3/8R, 3/8L and 1/2
- Washers are made from the highest quality neoprene and are precision molded for long life
- Bibb screws 3/8" x 8-32, 3/8" x 10-24 and 3/8" x 10-32
- Recloseable compartmentalized box includes a descriptive lid insert



PART NO.	DESCRIPTION	CTN/MSTR
J40161	205 Piece Assorted Flat Bibb Washer and Screw Kit	1/20

FLAT BIBB WASHER

- Washers are made from the highest quality neoprene and are precision molded for long life
- Low-swell material will maintain shape in water
- Pack of 25
- Carded



PART NO.	DESCRIPTION	CTN/MSTR
J40165	1/4S Flat Bibb Washer, Trade Size 00	12/144
J40166	1/4M Flat Bibb Washer Trade Size 0	12/144
J40167	1/4 Flat Bibb Washer, Trade Size 1/4	12/144
J40168	3/8L Flat Bibb Washer, Trade Size 3/8L	12/144

SEALS & GREASE

PLUMBER'S FAUCET AND VALVE GREASE, NON-TOXIC WATERPROOF SILICONE

- All purpose plumbing lubricant
- Non-toxic and safe to use in all potable water systems
- Reduces wear on faucets, valves and pumps
- Aids in installation of faucet spouts, O-rings and stem repair kits
- 1/2 oz. recloseable tub
- Carded



PART NO.	DESCRIPTION	CTN/MSTR
J40196	Plumber's Faucet and Valve Grease	6/144

24" PTFE TEFLON™ STYLE STRING PACKING

- Can be formed into washers, gaskets and packings
- Holds up to steam, alkalis and solvents
- 3/32" thick string, 24" overall length
- Will replace any size or shape of stem packing, simply wrap around stem and tighten down packing nut
- Can also be used to repair valves, pumps and other types of equipment
- Carded



PART NO.	DESCRIPTION	CTN/MSTR
J40160	24" PTFE Teflon™ Style String Packing	6/144

AERATORS & FAUCET END COMPONENTS

CHROME PLATED DUAL THREAD 15/16"- 27T LARGE MALE X 55/64"- 27T LARGE FEMALE NON-SLOTTED AERATOR

- Dual thread
- 15/16" x 27T large male thread
- 55/64" x 27T large female thread
- Chrome plated brass body
- Pressure compensating for constant flow from 20 to 80 PSI
- Anti-clogging dome screen filters sediment and particles
- Meets low lead requirements
- A01037 and A01075 are carded; A01070 is bagged (12 Pack)



PART NO.	DESCRIPTION	CEC COMPLIANT	CTN/MSTR
A01037	Dual Thread Non-Slotted .5 GPM Aerator, Carded	Yes	6/144
A01075	Dual Thread Non-Slotted 1.8 GPM Aerator, Carded	No	6/144
A01070	Dual Thread Non-Slotted 1.8 GPM Aerator, Pack of 12, Bagged	No	6/72

CHROME PLATED 55/64" - 27T LARGE FEMALE THREAD NON-SLOTTED AERATOR

- Large female thread
- 55/64" female
- Chrome plated brass body
- Pressure compensating for constant flow from 20 to 80 PSI
- Anti-clogging dome screen filters sediment and particles
- Meets low lead requirements
- Carded



PART NO.	DESCRIPTION	CEC COMPLIANT	CTN/MSTR
A01076	Non-Slotted .5 GPM Aerator	Yes	6/144
A01078	Non-Slotted 1.0 GPM Aerator	No	6/144
A01072	Non-Slotted 1.2 GPM Aerator	Yes	6/144
A01071	Non-Slotted 1.5 GPM Aerator	Yes	6/144
A01074	Non-Slotted 1.8 GPM Aerator	No	6/144

CHROME PLATED 15/16" - 27T LARGE MALE THREAD NON-SLOTTED AERATOR

- Chrome plated brass body
- Pressure compensating for constant flow from 20 to 80 PSI
- Anti-clogging dome screen filters sediment and particles
- Meets low lead requirements
- Carded



PART NO.	DESCRIPTION	CEC COMPLIANT	CTN/MSTR
A01077	Chrome Plated 15/16" - 27T Large Male Thread 1.0 GPM Aerator	Yes	6/72
A01073	Chrome Plated 13/16" - 27T Large Male Thread 1.5 GPM Aerator	Yes	6/144

ULTIMATE AERATOR REPAIR KIT

- Aerators and aerator inserts to fit large and small, male and female
- Includes an assortment of Cache style recessed inserts
- Color coded inserts for accurate flow rate determination
- 4 Cache keys for Standard, Junior, Tiny Junior and Tom Thumb™ sizes
- Includes Moen® and Delta® cache adapters
- Meets low lead requirements
- Recloseable compartmentalized box with descriptive lid insert



PART NO.	DESCRIPTION	CTN/MSTR
A01079	Ultimate Aerator Repair Kit	1/12

AERATOR TO GARDEN HOSE ADAPTER

- Dual thread to adapt faucet aerator thread to garden hose thread
- 15/16" x 27T large male thread
- 55/64" x 27T large female thread
- Male garden hose threads
- Lead free solid brass
- Meets low lead requirements
- Carded



PART NO.	DESCRIPTION	CTN/MSTR
A01042	Aerator to Garden Hose Adapter, Dual Thread	6/144

SPRAY HEADS & HOSES

REPLACEMENT HOSE FOR PULL-OUT KITCHEN FAUCETS

- Polished Chrome finish
- Replacement hose for pullout kitchen faucet
- Includes 60" hose
- Metal construction for long life and durability
- 1.8 GPM to meet CEC requirements
- Backflow preventor to prevent siphoning of dirty water into clean water systems
- Complete with adapters, washers and O-rings to fit most pull-out style kitchen faucets
- Meets low lead requirements
- Carded



PART NO.	DESCRIPTION	CTN/MSTR
K53090	Polished Chrome Replacement Hose	1/6

BLACK FIT-ALL KITCHEN SPRAY HEAD AND HOSE

- Black with Polished Chrome ring
- Fits all standard kitchen side spray assemblies
- Includes a 48" nylon reinforced hose
- Tapered locknut to fit most hose guides
- 1/4" female thread to fit 1/4" male spray outlets
- Includes brass adapter to fit old style 1/8" spray outlets
- Meets low lead requirements
- Carded



PART NO.	DESCRIPTION	CTN/MSTR
K52023	Black Fit-All Kitchen Spray Head and Hose	6/24

BLACK FIT-ALL KITCHEN SPRAY HEAD

- Black with Polished Chrome ring
- Fits all standard kitchen side spray assemblies
- Plastic construction
- Complete with clip to hold assembly onto hose
- Tapered locknut holds onto hose and fits most hose guides
- Meets low lead requirements
- Carded



PART NO.	DESCRIPTION	CTN/MSTR
K52001	Black Fit-All Kitchen Spray Head	1/12

FIT-ALL KITCHEN SPRAY HEAD

- Sleek modern design
- Fits all standard kitchen side spray assemblies
- Plastic construction
- Complete with clip to hold assembly onto hose
- Meets low lead requirements
- Carded



PART NO.	DESCRIPTION	CTN/MSTR
K53089	Chrome Plated Fit-All Kitchen Spray Head	1/12
K53092	Stainless Steel Fit-All Kitchen Spray Head	1/12

FACEPLATES & TRIM KITS

SINGLE HANDLE STAINLESS STEEL REMODEL TRIM PLATE

- Chrome Plated finish
- Move from a two or three handle faucet to a single handle faucet without replacing the entire wall or tile
- Plate will cover hot and cold holes leaving the center open for new single handle faucet
- Included mounting hardware uses old hot and cold holes – no additional holes necessary
- New faceplate will cover center hole of remodel plate
- Metal for long lasting durability
- Carded



PART NO.	DESCRIPTION	CTN/MSTR
T73819	Single Handle Stainless Steel Trim Plate	6/72

SINGLE HANDLE FACEPLATE FITS DELTA®

- Fits Delta® single handle ball style tub and shower faucets without push button diverter
- Replaces #RP5883
- Chrome plated stamped metal
- Complete with two chrome plated screws
- Includes rubber gaskets on OD and ID
- Bottom weep hole to allow excess moisture escape
- Carded



PART NO.	DESCRIPTION	CTN/MSTR
C25452	Chrome Plated Single Handle Faceplate fits Delta®	4/24

FACEPLATE SCREWS FITS DELTA®

- Fits most Delta® single handle faceplates and escutcheons
- Replaces #RP196
- Chrome plated stainless steel
- Stainless steel for corrosion resistance and rust-proof performance
- Pair
- Carded



PART NO.	DESCRIPTION	CTN/MSTR
C25462	Chrome Plated Faceplate Screws fits Delta®, Pair	6/144

The manufacturers' names are used only to describe whose products the items will fit. The items in this catalog are not manufactured by those companies.

SHOWER FLANGE SCREWS FITS MOEN® CHATEAU AND LEGEND

- Fits Moen® Magnum® Chateau and Legend tub and shower faucets
- Replaces #15528
- For single handle faucets
- Chrome plated stainless steel
- Beveled tip helps find female threaded portion of faucet for easy installation
- 2" overall length
- Carded



PART NO.	DESCRIPTION	CTN/MSTR
C25502	Shower Flange Screws fits Moen® Chateau and Legend Tub/Shower Faceplates	6/144

TRIM KIT FITS MOEN® CHATEAU SINGLE LEVER TUB/SHOWER FAUCETS

- Fits Moen® Chateau and Magnum tub and shower faucets
- Replaces #16090, #10089 and #96797
- Chrome plated faceplate and escutcheon sleeve tube
- Includes faceplate, faceplate screws, escutcheon sleeve and teardrop shaped acrylic crystal handle
- 7" diameter faceplate
- Works with #1200 brass cartridges or #1225 plastic cartridges
- Escutcheon includes rubber gaskets on OD and ID for water-tight installation
- Carded



PART NO.	DESCRIPTION	CTN/MSTR
T73400	Chrome Plated Trim Kit fits Moen® Chateau	6/24

STOP TUBE FITS MOEN® CHATEAU TUB/SHOWER FAUCETS

- Fits Moen® Magnum® Chateau and Legend tub and shower faucets
- Replaces #10089
- For single handle faucets
- Chrome plated stainless steel with plastic inserts
- Slides into center of #16090 faceplate to cover stem and housing
- Ridge on top of sleeve prevents handle from spinning a full 360°
- Carded

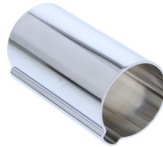

PART NO.	DESCRIPTION	CTN/MSTR
C25499	Chrome Plated Stop Tube fits Moen® Chateau	6/72

STOP TUBE FITS MOEN® POSI-TEMP® TUB/SHOWER FAUCETS

- Fits Moen® Posi-Temp® tub and shower faucets
- For single handle faucets
- Includes temperature limit stop to limit max water temperature
- 2-1/4" overall length, 2-1/16" sleeve length
- Carded



PART NO.	DESCRIPTION	CTN/MSTR
C25494	Chrome Plated Stop Tube fits Moen® Posi-Temp®, Replaces #96987	4/48
C25495	Brushed Nickel Stop Tube fits Moen® Posi-Temp®, Replaces #96987BN	4/48

MOUNTING HARDWARE

1/2" PLASTIC FAUCET LOCKNUT WITH STEEL ROSETTE AND RUBBER WASHER

- For installation of two-post style faucets
- 1/2" thread locknut
- With wings for easy hand grip or positive connection with wrench
- Rubber washer for strong grip against the underside of the counter
- Steel rosette to prevent the rubber washer from warping when tightened
- Carded



PART NO.	DESCRIPTION	CTN/MSTR
B10120	1/2" Plastic Faucet Locknut	6/144

BRASS BASIN NUT WITH CONE WASHER AND FRICTION RING

- Chrome Plated finish
- To attach riser or water line to kitchen or bathroom faucet
- 1/2" center hole for 1/2" OD risers
- Lead free solid brass nut for long life and corrosion resistance
- Rubber cone washer for positive seal and leak proof installation
- Brass friction ring to prevent washer from warping when tightening nut
- Carded



PART NO.	DESCRIPTION	CTN/MSTR
B10106	1/2" IPS x 1/2" Hole	6/144
B10107	1/2" IPS x 3/8" Hole	6/144

EASY CONNECT TEES

BRASS COMPRESSION EASY CONNECT TEE

- Creates a dual outlet valve without replacing the existing straight or angle supply stop
- Ideal for applications such as ice maker, dishwasher and water filtration system
- cUPC & IAPMO Listed
- Takes one 3/8" outlet and converts it to two 3/8" Comp outlets
- Meets or exceeds NSF/ANSI 61, NSF/ANSI 372, ASME A112.18.1-2018/CSA B125.1-18, and Section 1417(d) of the Safe Drinking Water Act
- Lead free
- Hot or cold water application acceptable
- Carded



PART NO.	DESCRIPTION	CTN/MSTR
C74250LF	3/8" Female Compression Swivel x 3/8" Male Compression x 3/8" Male Compression	6/144
C74251LF	3/8" Female Compression Swivel x 3/8" Male Compression x 1/4" Male Compression	6/144

STOPPERS

WHITE BASIN AND TUB STOPPER

- White rubber
- Tapered to fit multiple sizes of sink, lavatory or tub drains
- Fits 1-1/8" through 1-1/4" drain openings
- Chrome plated metal ring
- Duo-Fit, stopper fits two sizes of drain
- Carded



PART NO.	DESCRIPTION	CTN/MSTR
P35120	White Basin and Tub Stopper for 1-1/8" to 1-1/4" Drains	6/144
P35137	White Basin and Tub Stopper for 1-3/8" to 1-1/2" Drains	6/144
P35158	White Basin and Tub Stopper for 1-5/8" to 1-3/4" Drains	6/144

WHITE TUB AND LAUNDRY TUB STOPPER

- White rubber
- Fits most bathtub or laundry tub drains
- Fits 1-1/2" through 2" drain openings
- Chrome plated metal ring
- Oversized top to fit most drain openings
- Carded



PART NO.	DESCRIPTION	CTN/MSTR
P35161	White Tub and Laundry Tub Stopper	6/48

FLAT SUCTION SINK STOPPER

- White rubber
- For kitchen sinks or bathtubs
- Rubber cover fits over drain opening
- Natural suction of drain holds the stopper in place
- 5" OD
- With nub on top to lift stopper off of the drain
- Carded



PART NO.	DESCRIPTION	CTN/MSTR
P35162	Flat Suction Sink Stopper	6/48

POP-UP BASIN STOPPER FITS DELTA®

- Fits Delta® lavatory drains
- Replaces #RP5648
- Chrome plated stainless steel top
- 8-1/32" overall length
- 2-1/8" diameter top
- Rubber seal for positive leak-free performance
- Two bottom holes for multiple lift rod depths
- Carded



PART NO.	DESCRIPTION	CTN/MSTR
C25465	Chrome Plated Pop-Up Basin Stopper fits Delta®	6/72

POP-UP BASIN STOPPER FITS MOEN® KINGSLEY

- Fits Moen® Kingsley™ lavatory faucets
- Replaces #10709
- Chrome plated metal top
- 3-15/16" overall length
- 1-5/16" diameter top
- Beveled for positive leak-free performance
- Carded



PART NO.	DESCRIPTION	CTN/MSTR
C25504	Chrome Plated Pop-Up Basin Stopper fits Moen® Kingsley	6/72

FIT-ALL POP-UP PLUNGER

- Fits most brands of pop-up lavatory drains
- Extra long bottom with two holes will line up with most linkage assemblies
- Two flat areas on bottom will line up with gravity style linkages that do not use the holes
- 1-3/8" OD top
- Rubber gasket for positive seal
- Carded



PART CODE	DESCRIPTION	CTN/MSTR
P35950	Chrome Plated Fit-All Pop-Up Plunger	6/72
P36010	Brushed Nickel Fit-All Pop-Up Plunger	6/72

STRAINERS

FIT-ALL BASKET STRAINER

- Fits most brands
- Rolled edges, no sharp edges to cut or scrape the user
- Stainless steel
- Rubber bottom seal
- Adjustable center post
- Carded



PART NO.	DESCRIPTION	CTN/MSTR
B03010	Fit-All Stainless Steel Basket Strainer	6/48

REPLACEMENT BASKET FOR JUNIOR DUO BASKET STRAINER

- Replacement basket for junior duo basket strainer (B02050)
- Fits 2" drains
- Stainless steel
- Rubber bottom seal
- Center post
- Carded



PART NO.	DESCRIPTION	CTN/MSTR
B02049	Replacement Basket for Junior Duo Basket Strainer	6/72

3-PRONG DRAIN PROTECTOR

- Aluminum



PART NO.	DESCRIPTION	CTN/MSTR
D18062	1-5/8" 3-Prong Drain Protector	6/144
D18063	1-7/8" 3-Prong Drain Protector	6/144

STAINLESS STEEL MESH STRAINER

- Prevent debris from going down the drain and causing clogs
- Mesh style screen strainer
- Cup shaped center to go down into drain and hold strainer in place
- Stainless steel mesh and ring for long life and corrosion resistance
- Carded



PART NO.	DESCRIPTION	CTN/MSTR
P35190	Strainer for Lavatory	24/576
P35191	Strainer for Tub	24/576
P35192	Strainer for Shower	24/576
P35193	Strainer for Kitchen	24/436
P35194	Strainer for Lavatory, Tub and Kitchen, Pack of 3	6/108

FAUCET HOLE COVERS

SNAP-IN FAUCET HOLE COVER

- Fill unused holes in sinks and counters
- 1-1/2" diameter
- Bottom legs provide positive grip
- Snap into the hole, no tools necessary
- Stainless steel finish to match most sinks
- Carded



PART NO.	DESCRIPTION	CTN/MSTR
B10200L	1-1/2" Snap-In Faucet Hole Cover	6/144

FAUCET HOLE COVER WITH WASHER

- Fill unused holes in sinks and counters
- 1-3/4" diameter
- Large bottom washer for strong positive hold under the sink or counter
- Wing-nut for easy installation
- Stainless steel finish to match most sinks
- Carded



PART NO.	DESCRIPTION	CTN/MSTR
C06030	1-3/4" OD Faucet Hole Cover with Washer	6/72

WASTE & OVERFLOW TRIM

ONE-HOLE OVERFLOW PLATE WITH SCREW

- Chrome plated die cast construction
- Fits one-hole style bath waste & overflows
- One-hole pattern to match existing plate
- 3" OD
- Includes one chrome plated brass screw
- Carded



PART NO.	DESCRIPTION	CTN/MSTR
T05012L	Chrome Plated One-Hole Overflow Plate	6/72

TWO-HOLE OVERFLOW PLATE WITH SCREWS

- Chrome plated die cast construction
- Fits two-hole style bath waste & overflows
- Two-hole pattern to match existing plate
- 3" OD
- Includes two chrome plated brass screws
- Carded



PART NO.	DESCRIPTION	CTN/MSTR
T05013L	Chrome Plated Two-Hole Overflow Plate	6/72

TWO-HOLE TRIP LEVER OVERFLOW PLATE WITH SCREWS

- Chrome Plated die cast construction
- Fits bath waste & overflows with trip lever style drain
- 2-Hole pattern to match any trip Lever
- 3" OD
- Spring loaded trip mechanism for positive up or down movement
- Includes two chrome-plated brass screws
- Carded



PART NO.	DESCRIPTION	CTN/MSTR
B51025	Chrome Plated Two-Hole Trip Lever Overflow Plate	6/48

ONE-HOLE TOE TOUCH TUB DRAIN TRIM KIT, INCLUDES TWO-HOLE CONVERSION BAR

- One-hole faceplate; includes conversion bar for two-hole faceplates
- Toe touch stopper allows opening and closing without bending
- Fits most bath waste and overflows
- Includes overflow plate with adapter bar, flush bushing, threaded shoe, and toe touch stopper assembly
- Bushing allows interchangeability between 1-3/8" fine thread and 1-1/2" course thread bath shoes
- Carded



PART NO.	DESCRIPTION	CTN/MSTR
B51030	Chrome Plated One-Hole Toe Touch Tub Drain Trim Kit	1/6
B51031	Brushed Nickel One-Hole Toe Touch Tub Drain Trim Kit	1/6
B51038	Matte Black One-Hole Toe Touch Tub Drain Trim Kit	6/48

ONE-HOLE LIFT AND TURN TUB DRAIN TRIM KIT, INCLUDES TWO-HOLE CONVERSION BAR

- One-hole faceplate; includes conversion bar for two-hole faceplates
- Lift and Turn provides a positive lock
- Fits most bath waste and overflows
- Includes overflow plate with adapter bar, flush bushing, threaded shoe, and lift & turn stopper assembly
- Bushing allows interchangeability between 1-3/8" fine thread and 1-1/2" course thread bath shoes
- Carded



PART NO.	DESCRIPTION	CTN/MSTR
B51032	Chrome Plated One-Hole Lift and Turn Tub Drain Trim Kit	6/48
B51033	Brushed Nickel One-Hole Lift and Turn Tub Drain Trim Kit	6/48
B51039	Matte Black One-Hole Lift and Turn Tub Drain Trim Kit	6/48

ONE-HOLE FRICTION LIFT TUB DRAIN TRIM KIT, INCLUDES TWO-HOLE CONVERSION BAR

- One-hole faceplate; includes conversion bar for two-hole faceplates
- Heavy duty friction lift
- Fits most bath waste and overflows
- Includes overflow plate with adapter bar, flush bushing, threaded shoe, and friction lift stopper assembly
- Bushing allows interchangeability between 1-3/8" fine thread and 1-1/2" course thread bath shoes
- Carded



PART NO.	DESCRIPTION	CTN/MSTR
B51034	Chrome Plated One-Hole Friction Lift Tub Drain Trim Kit	6/48
B51035	Brushed Nickel One-Hole Friction Lift Tub Drain Trim Kit	6/48
B51040	Matte Black One-Hole Friction Lift Tub Drain Trim Kit	6/48

TWO-HOLE TRIP LEVER TUB DRAIN TRIM KIT

- Two-hole faceplate
- Trip lever style bath drain
- Fits most bath waste and overflows
- Includes trip lever overflow plate (with spring), flush bushing, threaded shoe, and stainless steel grid (with matching screw)
- Bushing allows interchangeability between 1-3/8" fine thread and 1-1/2" course thread bath shoes
- Plunger sold separately
- Carded



PART NO.	DESCRIPTION	CTN/MSTR
B51036	Chrome Plated Two-Hole Trip Lever Tub Drain Trim Kit	6/48
B51037	Brushed Nickel Two-Hole Trip Lever Tub Drain Trim Kit	6/48
B51043	Matte Black Two-Hole Trip Lever Tub Drain Trim Kit	6/48

The manufacturers' names are used only to describe whose products the items will fit. The items in this catalog are not manufactured by those companies.

TRIP LEVER TUB DRAIN LINKAGE ASSEMBLY

- Solid brass construction
- Fits brass trip lever style waste & overflow drains
- Up to 15" adjustable clevis
- Fits most bath waste and overflows
- Includes cotter pin and all necessary hardware for installation
- Carded



PART NO.	DESCRIPTION	CTN/MSTR
B51041	Brass Trip Lever Tub Drain Linkage Assembly with Plunger	6/48

TRIP LEVER TUB DRAIN LINKAGE ASSEMBLY WITH PLASTIC PLUNGER

- Plastic plunger with solid brass linkage
- Fits plastic trip lever style waste & overflow drains
- Up to 15" adjustable clevis
- O-rings seal on plunger for water-tight seal
- Fits most bath waste and overflows
- Includes cotter pin and all necessary hardware for installation
- Carded



PART NO.	DESCRIPTION	CTN/MSTR
B51042	Brass Trip Lever Tub Drain Linkage Assembly with Plastic Plunger	6/48

BEVELED BATH WASTE FACEPLATE GASKET

- Fits flush between outside of tub and overflow drain head
- Tapered shape to match slope of outside of tub
- Made of sponge rubber to achieve watertight seal on rough surface
- 3-3/16" OD x 2-1/8" ID
- Tapers from 9/16" thick to 3/16" thick
- Carded



PART NO.	DESCRIPTION	CTN/MSTR
T05028	Beveled Bath Waste Faceplate Gasket	6/72

TUB SPOUTS

FIT-ALL DIVERTER SPOUT

- Chrome plated finish
- Fit-all style replaces most diverter spouts
- 1/2" copper slide-on, 1/2" IPS thread-on or 3/4" IPS thread-on
- Front diverter - pull up to send water to shower head, push down to send water to tub
- Heavy die-cast construction
- Carded



PART NO.	DESCRIPTION	CTN/MSTR
D01701	Chrome Plated Fit-All Diverter Spout	1/6

DIVERTER SPOUT GATE REPAIR KIT

- Chrome plated finish
- Repair leaking diverter tub spouts
- Complete with lift rod, lift button, white plastic gate, gate washer and O-ring seal
- Fits most diverter spouts with pull-up diverter mechanism at the front of the spout
- Easy to install
- Carded



PART NO.	DESCRIPTION	CTN/MSTR
D01702	Diverter Spout Gate Repair Kit	6/72

SHOWER ACCESSORIES

SHOWER ARM WITH FLANGE

- Chrome Plated finish
- Plated stamped stainless steel flange with grip-tite legs to hold it in place against the shower arm
- 45° for proper shower head angle
- 1/2" threads
- Carded



PART NO.	DESCRIPTION	CTN/MSTR
S01044L	6" Chrome Plated Shower Arm	6/72
S01045L	8" Chrome Plated Shower Arm	6/72

S-SHAPED SHOWER ARM

- Chrome Plated stainless steel arm
- Raises shower head 6"
- Plated stamped stainless steel flange with grip-tite legs to hold it in place against the shower arm
- 45° for proper shower head angle
- 1/2" threads
- Carded



PART NO.	DESCRIPTION	CTN/MSTR
S01110	Chrome Plated S-Shaped Shower Arm with 6" Rise and Flange	1/6

SHOWER ARM FLANGE WITH SET SCREW

- Chrome plated finish
- Fits shower arms and other 1/2" IPS applications
- Heavy die cast construction
- 2-1/2" OD
- Includes set screw
- F05050 is carded; F05051 is bagged



PART NO.	DESCRIPTION	CTN/MSTR
F05050	2-1/2" OD Chrome Plated Shower Arm Flange, Carded	6/72
F05051	2-1/2" OD Chrome Plated Shower Arm Flange, Bagged	12/144

SHOWER HEADS

DIE CAST ADJUSTABLE SHOWER HEAD

- Chrome Plated finish
- Metal body, ball and nut for long life and durability
- 2" face
- Lever turns to adjust spray pattern
- 1.8 GPM to meet CEC requirements
- Carded



PART NO.	DESCRIPTION	CTN/MSTR
S01017	2" Chrome Plated Die Cast Adjustable Shower Head, 1.8 GPM	1/12

BRASS ADJUSTABLE SHOWER HEAD

- Chrome Plated finish
- Brass body, ball and nut for long life and durability
- "Princess" style
- Lever turns to adjust spray pattern
- 1.8 GPM to meet CEC requirements
- Carded



PART NO.	DESCRIPTION	CTN/MSTR
S01018	1-3/4" Chrome Plated Brass Adjustable Shower Head, 1.8 GPM	1/12
S01019	2-1/4" Chrome Plated Brass Adjustable Shower Head, 1.8 GPM	1/12

BRASS WATER VOLUME CONTROLLER FOR SHOWER HEADS

- Chrome Plated finish
- Water saver - regulates water flow at shower head
- Brass construction for long life and durability
- Large lever for easy grip with wet hands
- Ball style control mechanism
- Carded



PART NO.	DESCRIPTION	CTN/MSTR
S01060	Chrome Plated Brass Water Volume Controller	6/144

GASKETS & PACKING

RED RUBBER GASKET MATERIAL

- Cut your own customized gaskets
- 6" square sheet
- 1/18" thick
- Red
- Cut into washers, shims, gaskets, seals, vibration dampers or packings
- Bagged with header card



PART NO.	DESCRIPTION	CTN/MSTR
G55001	6"x 6" Red Rubber Gasket Material	6/72

GARDEN HOSE PARTS & ACCESSORIES

BRASS GARDEN HOSE WYE WITH SHUT-OFFS

- Brass construction
- Shutoff levers are plastic
- Includes washer
- Brass female swivel nut with rubber gripper sleeve
- For outdoor use only
- Not for potable water applications
- Carded



PART NO.	DESCRIPTION	CTN/MSTR
G20053L	Brass Garden Hose Wye With Shut-Offs	6/36

GARDEN HOSE SHUT-OFF

- Inline shut-off for garden hoses and accessories
- Can be installed at the faucet or at the accessory
- Includes hose washer
- Solid brass construction for long lasting durability
- Ball style shut-off for positive on and off performance
- Carded



PART NO.	DESCRIPTION	CTN/MSTR
G20090	Brass Garden Hose Shut-Off	6/72

HVAC PARTS

RADIATOR COIN AIR VALVE AND KEY

- Used to remove air from hot water heating systems to assure maximum performance from radiators
- 1/8" male IPT thread
- Nickel plated brass for long life and corrosion resistance
- Key fits slotted or square broaches
- Key has hanger hole for string or chain
- Carded



PART NO.	DESCRIPTION	CTN/MSTR
R20001L	Radiator Coin Air Valve and Key	6/72

PUMPS

SELF PRIMING QUICK SHAKE SIPHON STYLE PUMP KIT

- Ideal to transfer water, gasoline, diesel fuel, kerosene, fertilizer, insecticides and lubricants
- 6' long transfer hose
- 3/4" copper anti-static siphon valve with glass ball and stainless steel shaker spring
- Not for use with liquids that have a thickness greater than 20 grade oil
- 2.5 GPM max flow rate
- Do not use to siphon gasoline from an automobile
- Complete usage instructions on the package
- Carded



PART NO.	DESCRIPTION	CTN/MSTR
P13605	Self Priming Quick Shake Siphon Style Pump Kit	6/24

QUICK MINI TRANSFER PUMP KIT

- Ideal to quickly transfer any fluid including oil and gasoline
- Also works as an air pump
- Can be used to inflate balls, rafts, pool floats or bike tires
- Comes with hand pump, two transfer hoses, dipstick tube, air hose, two air hose adapters and three hose/tube connectors
- Complete usage instructions on the package
- Carded



PART NO.	DESCRIPTION	CTN/MSTR
P13610	Quick Mini Transfer Pump Kit	6/24

HOW TO FIND A REPLACEMENT STEM/CARTRIDGE

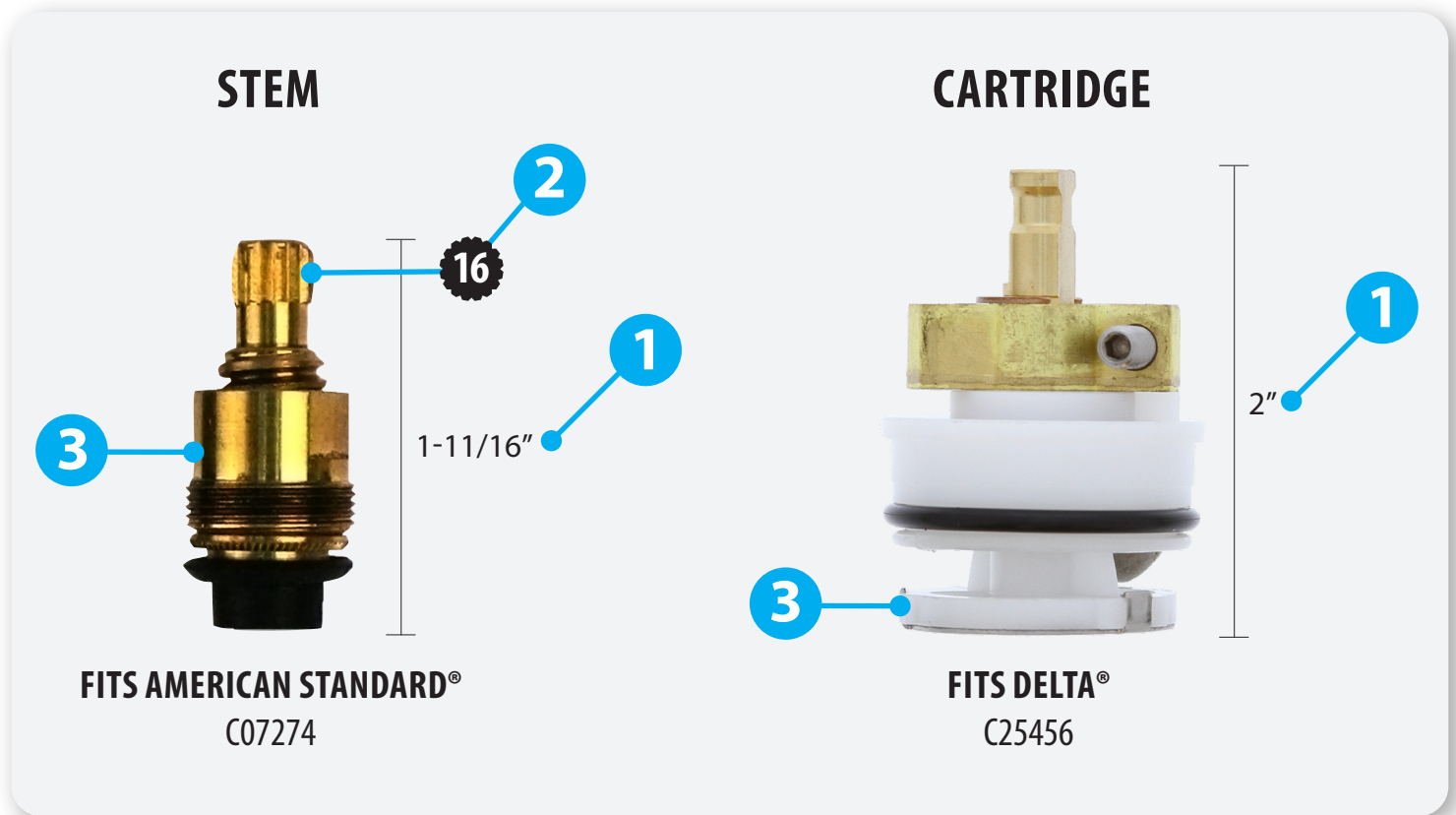

- 1** Measure the length, then turn to appropriate range section of this catalog.
- 2** Count the splines (raised at the tip of the stem/cartridge) or identify the shape to match accuracy and handle fit. If the top does not have ridged splines, note the shape (square, rectangular, half-moon, etc.).
- 3** Compare your part to the true-size images on the pages.

Having trouble identifying the correct cartridge?

Our world class customer service team is here to help! Give us a call at 800-355-6637 or email us at parts@jonesstephens.com and we'll find the right part for you.

Pages 36-42 represent the actual size of stems and cartridges. For additional product attributes, view pages 13-21 in catalog or at www.jonesstephens.com.

The manufacturers' names are used only to describe whose products the items will fit. The items in this catalog are not manufactured by those companies.

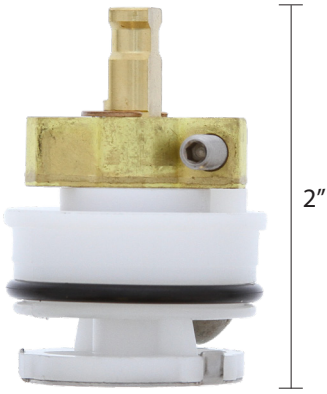

FITS DELTA®
C25456



FITS DELTA®/DELEX®
AND PEERLESS®
C25433
C25436



FITS DELTA®/DELEX®
AND PEERLESS®
C25434
C25437

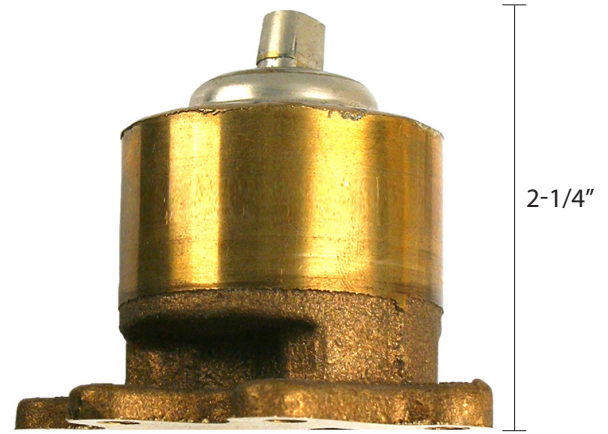

FITS PFISTER®
C07755

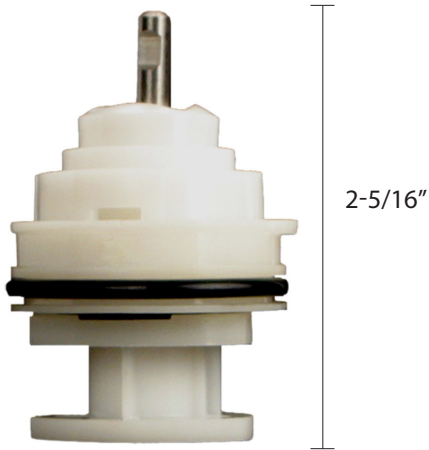

FITS VALLEY®
C1770CH

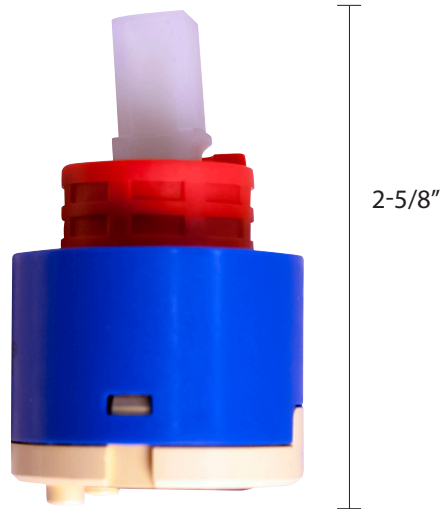

FITS ZURN®, SYMMONS®, JONES STEPHENS®
AND AQUAPLUMB®
C07651



FITS DELTA®
C25450





3-1/4"

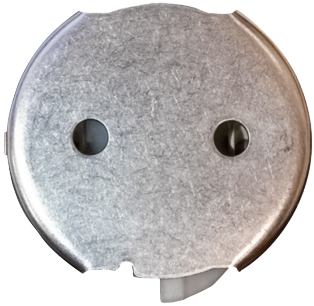

FITS DELTA®
C25449



3-7/16"

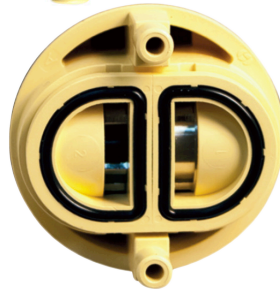

FITS GLACIER BAY® AND ZURN®
C07650



3-7/16"

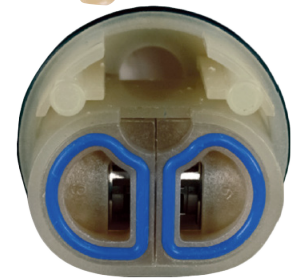

FITS GLACIER BAY®
C07655



4"

FITS DELTA®
C25447
C25463



4-1/8"

FITS MOEN®
C1777S
C1777TSX5



4-3/16"

FITS MOEN®
C1776TS
C1776TSX5

The manufacturers' names are used only to describe whose products the items will fit. The items in this catalog are not manufactured by those companies.



FITS MOEN®
C1775TS

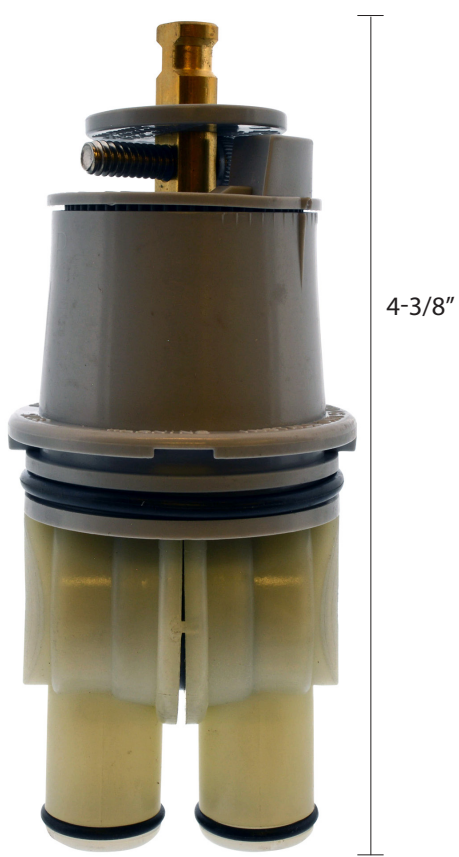

FITS DELTA®
C25451
C25464



FITS GLACIER BAY®
C07656



FITS MOEN
C25476

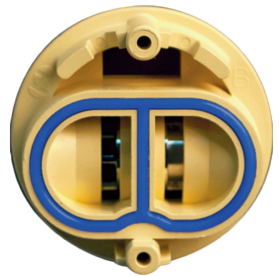



FITS MOEN
C25479 (hot)
C25478 (cold)



**FITS AMERICAN
STANDARD®**
C07274



FITS DELTA®/DELEX® AND PEERLESS®
C25435
C25461
C25466

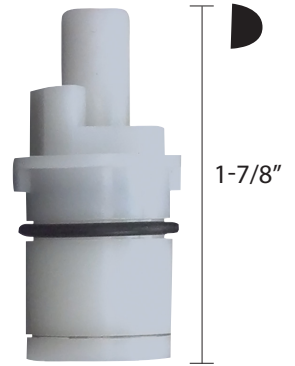

FITS VALLEY
C07229



FITS GLACIER BAY
C07626 (hot)
C07676 (cold)



FITS DELTA®/DELEX® AND PEERLESS®
C25448
C25467

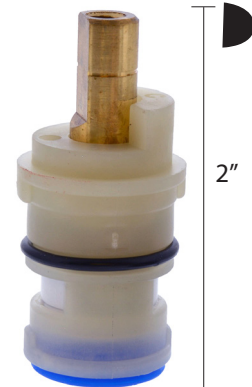

FITS GLACIER BAY® AND AQUASOURCE®
C07627 (hot)
C07677 (cold)



**FITS ALTMANS®
AND SEARS®**
C07632 (hot)
C07682 (cold)



FITS JADO®
C07637 (hot)
C07687 (cold)



FITS CRANE®
C07411 (hot)
C07412 (cold)



20

2-3/8"

FITS SPEAKMAN®
C07641 (hot)
C07691 (cold)



16

2-1/2"

FITS VALLEY®
C07225



16

2-5/8"

FITS ALTMANS®
C07633 (hot)
C07683 (cold)



16

2-5/8"

FITS NEWPORT BRASS®
C07645 (hot)
C07695 (cold)



16

2-5/8"

FITS MOEN®
C1765CH



16

3"

**FITS DELTA®/DELEX®
AND PEERLESS®**
C25453



16

3-1/2"

FITS HARDEN®
C07625 (hot)
C07675 (cold)



16

4-1/4"

FITS STERLING®
C07323



12

3-9/16"

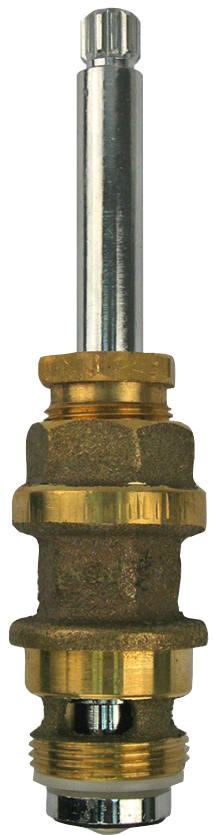

12

4-5/16"

FITS PFISTER®
C07404



12
4-5/16"



12
4-5/16"



16
4-9/16"

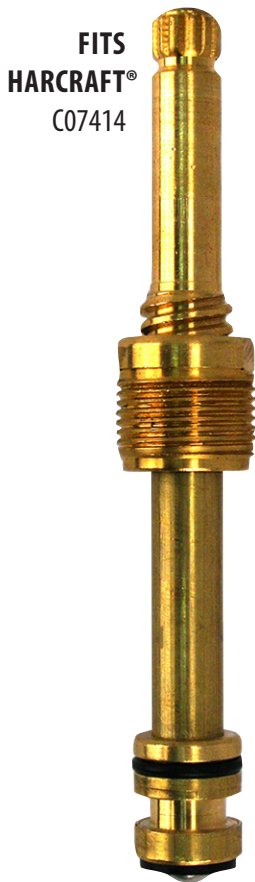

12
4-9/16"



16
4-5/8"

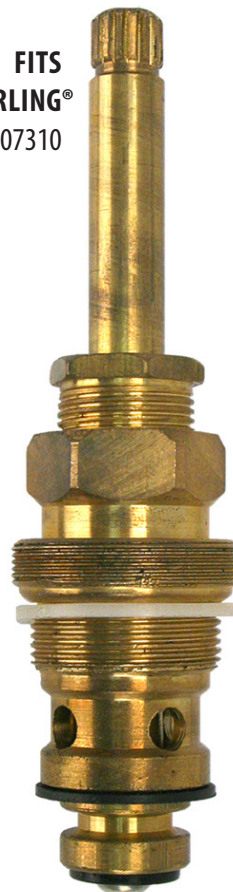

16
4-11/16"

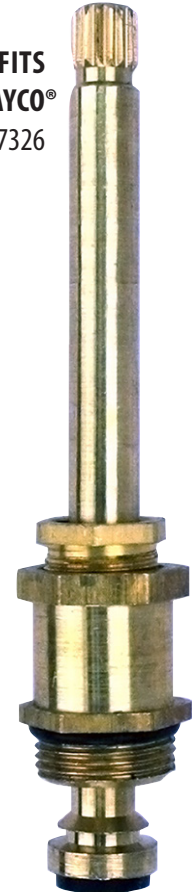

16
4-11/16"

The manufacturers' names are used only to describe whose products the items will fit. The items in this catalog are not manufactured by those companies.

FITS
SAYCO®
C07417

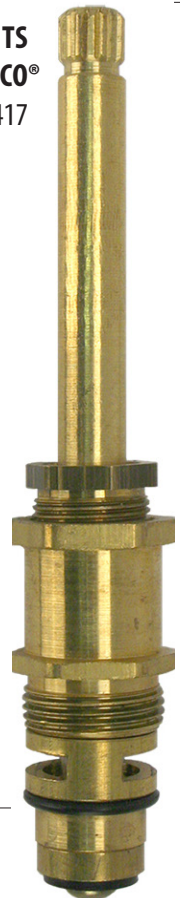

16

4-11/16"

FITS
STERLING®
C07308

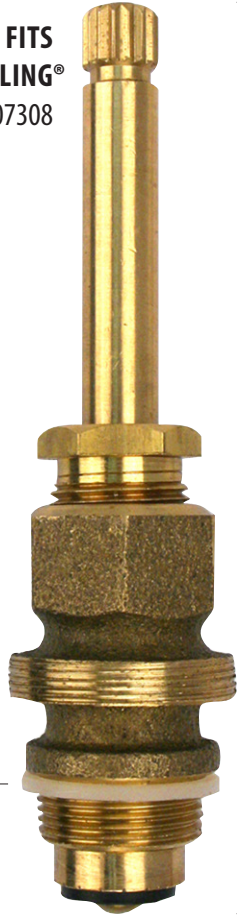

16

4-3/4"

FITS
PFISTER®
C07453



12

5-1/16"

FITS
GERBER®
C07435



16

5-7/16"

FITS
PFISTER®
C07461



12

5-9/16"

FITS
PFISTER®
C07462

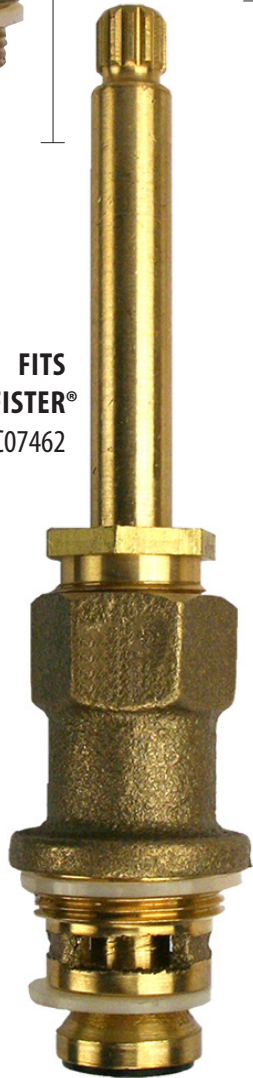

12

5-5/8"

FITS
PFISTER®
C07487



12

6"



JONES STEPHENS **REPAIR PARTS**

Visit www.jonesstephens.com for more details.

