

Split System Heat Pump

MODELS

Air Handling Unit

FTQ18TAVJUA
FTQ24TAVJUA
FTQ30TAVJUA
FTQ36TAVJUA
FTQ42TAVJUA
FTQ48TAVJUA

FTQ18TAVJUD
FTQ24TAVJUD
FTQ30TAVJUD
FTQ36TAVJUD
FTQ42TAVJUD
FTQ48TAVJUD

English

Français

Español

Read these instructions carefully before installation. Keep this manual in a handy place for future reference. This manual should be left with the equipment owner.

Lire soigneusement ces instructions avant l'installation.
Conserver ce manuel à portée de main pour référence ultérieure.
Ce manuel doit être donné au propriétaire de l'équipement.

Lea cuidadosamente estas instrucciones antes de instalar.
Guarde este manual en un lugar a mano para leer en caso de tener alguna duda. Este manual debe permanecer con el propietario del equipo.

WARNING

ONLY PERSONNEL THAT HAVE BEEN TRAINED TO INSTALL, ADJUST, SERVICE OR REPAIR (HEREINAFTER, "SERVICE") THE EQUIPMENT SPECIFIED IN THIS MANUAL SHOULD SERVICE THE EQUIPMENT. THE MANUFACTURER WILL NOT BE RESPONSIBLE FOR ANY INJURY OR PROPERTY DAMAGE ARISING FROM IMPROPER SERVICE OR SERVICE PROCEDURES. IF YOU SERVICE THIS UNIT, YOU ASSUME RESPONSIBILITY FOR ANY INJURY OR PROPERTY DAMAGE WHICH MAY RESULT. IN ADDITION, IN JURISDICTIONS THAT REQUIRE ONE OR MORE LICENSES TO SERVICE THE EQUIPMENT SPECIFIED IN THIS MANUAL, ONLY LICENSED PERSONNEL SHOULD SERVICE THE EQUIPMENT. IMPROPER INSTALLATION, ADJUSTMENT, SERVICING OR REPAIR OF THE EQUIPMENT SPECIFIED IN THIS MANUAL, OR ATTEMPTING TO INSTALL, ADJUST, SERVICE OR REPAIR THE EQUIPMENT SPECIFIED IN THIS MANUAL WITHOUT PROPER TRAINING MAY RESULT IN PRODUCT DAMAGE, PROPERTY DAMAGE, PERSONAL INJURY OR DEATH.

PROP 65 WARNING FOR CALIFORNIA CONSUMERS

WARNING

Cancer and Reproductive Harm -
www.P65Warnings.ca.gov

0140M00513-A



CONTENTS

accidents only.

1. SAFETY INSTRUCTIONS 2

2. BEFORE OPERATION 4

3. OPERATION RANGE 5

4. INSTALLATION SITE 5

5. LABELS AND CORRESPONDING FUNCTIONS OF THE REMOTE CONTROLLER 6

6. OPERATION PROCEDURE 6

7. OPTIMUM OPERATION 9

8. MAINTENANCE (FOR SERVICE PERSONNEL) 9

9. MALFUNCTIONS NOT RELATED TO HEAT PUMP 11

10. TROUBLESHOOTING 12

11. AIR HANDLER HOMEOWNER’S ROUTINE MAINTENANCE RECOMMENDATIONS 16

1. SAFETY INSTRUCTIONS

Read these “SAFETY INSTRUCTIONS for Installation” carefully before installing an air conditioner or heat pump. After completing the installation, make sure that the unit operates properly during the startup operation.

Instruct the customer on how to operate and maintain the unit. Inform customers that they should store this Installation Manual with the Operation Manual for future reference.

Always use a licensed installer or contractor to install this product. Improper installation can result in water or refrigerant leakage, electrical shock, fire, or explosion.

This air conditioner comes under the term “appliances not accessible to the general public.”

Meanings of **DANGER**, **WARNING**, **CAUTION** and **NOTE** Symbols:

 **DANGER**..... Indicates an imminently hazardous situation which, if not avoided, will result in death or serious injury.

 **WARNING**..... Indicates a potentially hazardous situation which, if not avoided, could result in death or serious injury.

 **CAUTION**..... Indicates a potentially hazardous situation which, if not avoided, may result in minor or moderate injury. It may also be used to alert against unsafe practices.

 **NOTE**..... Indicates situations that may result in equipment or property-damage

 **DANGER**

- Refrigerant gas is heavier than air and replaces oxygen. A massive leak can lead to oxygen depletion, especially in basements, and an asphyxiation hazard could occur leading to serious injury or death.
- Do not ground units to water pipes, gas pipes, telephone wires, or lightning rods as incomplete grounding can cause a severe shock hazard resulting in severe injury or death. Additionally, grounding to gas pipes could cause a gas leak and potential explosion causing severe injury or death.
- If refrigerant gas leaks during installation, ventilate the area immediately. Refrigerant gas may produce toxic gas if it comes in contact with fire. Exposure to this gas could cause severe injury or death.
- After completing the installation work, check that the refrigerant gas does not leak throughout the system.
- Do not install unit in an area where flammable materials are present due to risk of explosions that can cause serious injury or death.
- Safely dispose all packing and transportation materials in accordance with federal/state/local laws or ordinances. Packing materials such as nails and other metal or wood parts, including plastic packing materials used for transportation may cause injuries or death by suffocation.

 **WARNING**

- All phases of the field-installation, including, but not limited to, electrical, piping, safety, etc. must be in accordance with manufacturer’s instructions and must comply with national, state, provincial and local codes.
- Only qualified personnel must carry out the installation work. Installation must be done in accordance with this installation manual. Improper installation may result in water leakage, electric shock, or fire.
- When installing the unit in a small room, take measures to keep the refrigerant concentration from exceeding allowable safety limits. Excessive refrigerant leaks, in the event of an accident in a closed ambient space, can lead to oxygen deficiency.
- Use only specified accessories and parts for installation work. Failure to use specified parts may result in water leakage, electric shocks, fire, or the unit falling.
- Install the air conditioner or heat pump on a foundation strong enough that it can withstand the weight of the unit. A foundation of insufficient strength may result in the unit falling and causing injuries.
- Take into account strong winds, typhoons, or earthquakes when installing. Improper installation may result in the unit falling and causing accidents.

- Make sure that a separate power supply circuit is provided for this unit and that all electrical work is carried out by qualified personnel according to local, state, and national regulations. An insufficient power supply capacity or improper electrical construction may lead to electric shocks or fire.
- Make sure that all wiring is secured, that specified wires are used, and that no external forces act on the terminal connections or wires. Improper connections or installation may result in fire.
- When wiring, position the wires so that the access panel can be securely fastened. Improper positioning of the access panel may result in electric shocks, fire, or the terminals overheating.
- Before touching electrical parts, turn off the unit.
- This equipment can be installed with a Ground-Fault Circuit Breaker (GFCI). Although this is a recognized measure for additional protection, with the grounding system in North America, a dedicated GFCI is not required.
- Securely fasten the outside unit terminal cover (panel). If the terminal cover/panel is not installed properly, dust or water may enter the outside unit causing fire or electric shock.
- When installing or relocating the system, keep the refrigerant circuit free from substances other than the specified refrigerant (R-410A) such as air. Any presence of air or other foreign substance in the refrigerant circuit can cause an abnormal pressure rise or rupture, resulting in injury.
- Do not change the setting of the protection devices. If the pressure switch, thermal switch, or other protection device is shorted and operated forcibly, or parts other than those specified by Daikin are used, fire or explosion may occur.
- Heat exchanger fins are sharp enough to cut. To avoid injury wear gloves or cover the fins when working around them.
- Be careful when transporting the product.
- Do not turn off the power immediately after stopping operation. Always wait for at least 5 minutes before turning off the power. Otherwise, water leakage may occur.
- Do not touch the refrigerant pipes during and immediately after operation as the refrigerant pipes may be hot or cold, depending on the condition of the refrigerant flowing through the refrigerant piping, compressor, and other refrigerant cycle parts. Your hands may suffer burns or frostbite if you touch the refrigerant pipes. To avoid injury, give the pipes time to return to normal temperature or, if you must touch them, be sure to wear proper gloves.
- Do not use a charging cylinder. Using a charging cylinder may cause the refrigerant to deteriorate.
- Refrigerant R-410A in the system must be kept clean, dry, and tight.
 - (a) Clean and Dry — Foreign materials (including mineral oils such as SUNISO oil or moisture) should be prevented from getting into the system.
 - (b) Tight — R-410A does not contain any chlorine, does not destroy the ozone layer, and does not reduce the earth's protection against harmful ultraviolet radiation. R-410A can contribute to the greenhouse effect if it is released. Therefore take proper measures to check for the tightness of the refrigerant piping installation. Read the chapter Refrigerant Piping and follow the procedures.
- Since R-410A is a blend, the required additional refrigerant must be charged in its liquid state. If the refrigerant is charged in a state of gas, its composition can change and the system will not work properly. The indoor unit is for R-410A. See the catalog for indoor models that can be connected. Normal operation is not possible when connected to other units.

⚠ CAUTION

- Do not touch the switch with wet fingers. Touching switch with wet fingers can cause electric shock.
- Do not allow children to play on or around the unit to prevent injury.
- Do not touch the refrigerant pipes during and immediately after operation as the refrigerant pipes may be hot or cold, depending on the condition of the refrigerant flowing through the refrigerant piping, compressor, and other refrigerant cycle parts. Your hands may suffer burns or frostbite if you touch the refrigerant pipes. To avoid injury, give the pipes time to return to normal temperature or, if you must touch them, be sure to wear proper gloves.
- Install drain piping to proper drainage. Improper drain piping may result in water leakage and property damage.
- Insulate piping to prevent condensation.
- Remote controller (wireless kit) transmitting distance can be shorter than expected in rooms with electronic fluorescent lamps (inverter or rapid start types). Install the indoor unit far away from fluorescent lamps as much as possible.
- Indoor units are for indoor installation only. Outdoor units can be installed either outdoors or indoors. This unit is for indoor use.
- Do not install the air conditioner or heat pump in the following locations:
 - (a) Where a mineral oil mist or oil spray or vapor is produced, for example, in a kitchen.
 - Plastic parts may deteriorate and fall off or result in water leakage.
 - (b) Where corrosive gas, such as sulfurous acid gas, is produced. Corroding copper pipes or soldered parts may result in refrigerant leakage.

(c) Near machinery emitting electromagnetic waves. Electromagnetic waves may disturb the operation of the control system and cause the unit to malfunction.

(d) Where flammable gas may leak, where there is carbon fiber, or ignitable dust suspension in the air, or where volatile flammables such as thinner or gasoline are handled. Operating the unit in such conditions can cause a fire.

- Take adequate measures to prevent the outside unit from being used as a shelter by small animals. Small animals making contact with electrical parts can cause malfunctions, smoke, or fire. Instruct the customer to keep the area around the unit clean.

NOTE

- Install the power supply and control wires for the indoor and outdoor units at least 3.5 feet away from televisions or radios to prevent image interference or noise. Depending on the radio waves, a distance of 3.5 feet may not be sufficient to eliminate the noise.
- Dismantling the unit, treatment of the refrigerant, oil and additional parts must be done in accordance with the relevant local, state, and national regulations.
- Do not use the following tools that are used with conventional refrigerants: gauge manifold, charge hose, gas leak detector, reverse flow check valve, refrigerant charge base, vacuum gauge, or refrigerant recovery equipment.
- If the conventional refrigerant and refrigerator oil are mixed in R-410A, the refrigerant may deteriorate.
- This air conditioner or heat pump is an appliance that should not be accessible to the general public.
- As design pressure is 450 psi, the wall thickness of field-installed pipes should be selected in accordance with the relevant local, state, and national regulations.

2. BEFORE OPERATION

This operation manual is for the following system with standard control. Before initiating operation, contact your dealer for the operation that corresponds to your system.

Outdoor unit

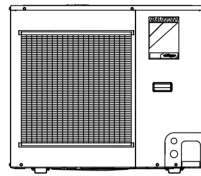

or

Outdoor unit

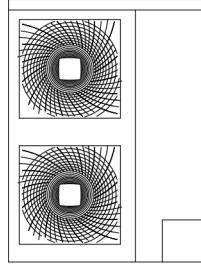

Indoor unit

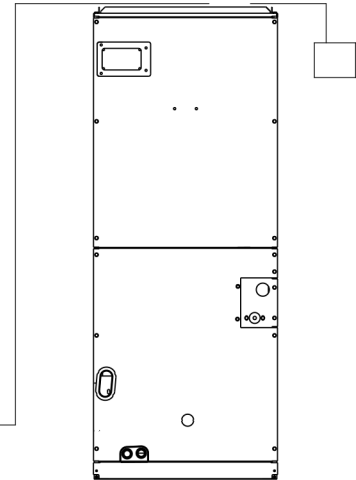

Unit with
remote controller

NOTE: If the unit you purchased is controlled by the wired remote controller (BRC1E73), refer to the operation manual of the wired remote controller (BRC1E73).

If your installation has a customized control system, ask your dealer for the operation that corresponds to your system.

TWO REMOTE CONTROLLERS CONTROL SYSTEM

Confirm the following if your unit is the following control system type:

- **Two remote controllers control system**

Two remote controllers control one indoor unit. The unit is individually operated.

NOTE: Contact your dealer in case of two remote controllers control system.

3. OPERATION RANGE

If the temperature or the humidity is beyond the “following conditions, safety devices may work and the air conditioner or heat pump may not operate, or sometimes, water may drop from the indoor unit.

OPERATION	TEMPERATURE (°F)	
	OUTDOOR	INDOOR
COOLING	23 TO 122 (DB)	57.2 TO 77 (WB)
HEATING	-4 TO 60 (WB)	59 TO 80.6 (DB)

DB: Dry Bulb Temperature

WB: Wet Bulb Temperature

The setting temperature range of the remote controller is 60°F to 90°F.

4. INSTALLATION SITE

Regarding places for installation:

- **Is the air conditioner or heat pump installed at a well-ventilated place where there are no obstacles around?**
- **Do not use the air conditioner or heat pump in the following places:**
 - a. An atmosphere laden with mineral oil
 - b. Places with an abundance of salt such as coastal areas
 - c. Where sulfured gas exists such as a hot spring resort
 - d. Where there are considerable voltage fluctuations such as a factory or plant
 - e. Vehicles and vessels
 - f. A place like a kitchen with a lot of oil and vapor
 - g. Where there are machines generating electromagnetic waves
 - h. An areas filled with acid and/or alkaline steam or vapor
- **Is a snow protection measure taken?**

For details, consult your dealer.

Regarding wiring:

- **All wiring must be performed by an authorized electrician.**

To do wiring, ask your dealer. Never do it by yourself.
- **Make sure that a separate power supply circuit is provided for this air conditioner or heat pump and that all electrical work is carried out by qualified personnel according to local laws and regulations.**

Pay attention to the installation location:

- **Are the following places selected?**
 - a. A place that can sufficiently withstand the weight of the air conditioner or heat pump with minimal vibration and operation sound.
 - b. A place where the air discharged from the outlet of the outdoor unit and the running sound do not become bothersome.
- **Are you sure that there are no obstacles near the air outlet of the outdoor unit?**

Such obstacles may result in declined performance and increased running sound.
- **If abnormal sounds occur in use, stop the operation of the air conditioner or heat pump and consult your dealer.**

Regarding drainage of drain piping:

- **Is the drain piping executed to perform complete drainage?**

If proper drainage is not carried out from the outdoor drain pipes during air-conditioning operation, chances are that dust and dirt are clogged in the pipe. This may result in a water leakage from the indoor unit. Under such circumstances, stop the operation of the air conditioner or heat pump, and then consult your dealer or our service station.

5. LABELS AND CORRESPONDING FUNCTIONS OF THE REMOTE CONTROLLER

The illustrations in this operating manual correspond to the remote control format BRC1E type. Refer to Figure 1.

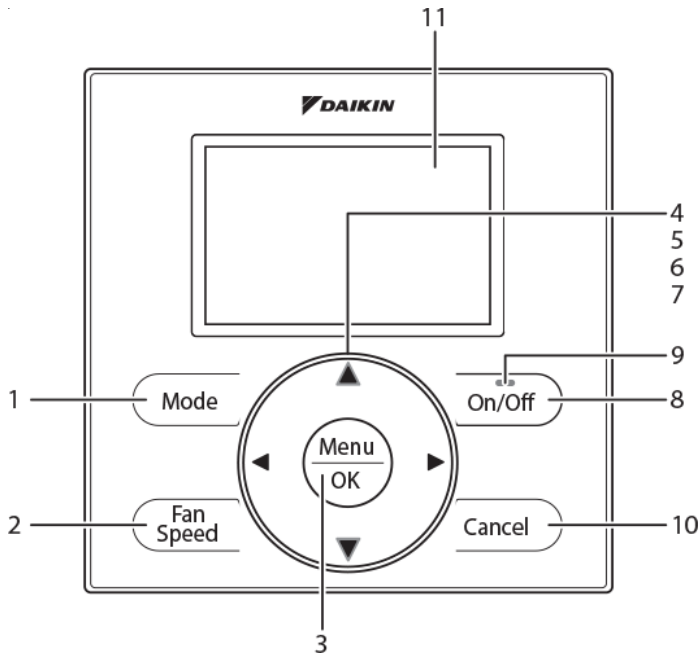

Figure 1

1. Operation Mode Selector Button

- Used to change the mode.

2. Fan Speed Control Button

- Used to change the fan control.

3. Menu/OK Button

- Used to indicate the main menu (For details of the main menu, see the operations manual).
- Used to enter the item selected.

Main Menu
Air Flow Direction
Ventilation
Schedule
Off Timer
Celsius/Fahrenheit
Maintenance Information
Configuration
Current Settings
Clock & Calendar
Daylight Saving Time
Language

*Depending on connected model

4. Up Button

- Used to raise the setpoint temperature.
- The previous menu items will be highlighted. (The highlighted items will be scrolled continuously when the button is pressed continuously.)
- Used to change the selected item.

5. Down Button

- Used to lower the setpoint temperature.
- Items below the currently selected item will be highlighted. (The highlighted items will be scrolled continuously when the button is pressed continuously.)
- Used to change the selected item.

6. Right Button

- Used to highlight items to the right of the currently selected item.
- Display contents are changed to next screen per page.

7. Left Button

- Used to highlight items to the left of the currently selected item.
- Display contents are changed to previous screen per page.

8. On/Off Button

- Press once to operate, and press once again to stop.

9. Operation Lamp

- Green lamp lights up during operation. The lamp will blink if a malfunction occurs.

10. Cancel Button

- Used to return to the previous screen.
- Press and hold this button for 4 seconds or longer to display service settings menu.

11. LCD (with backlight)

- The backlight will illuminate for approximately 30 seconds by pressing any operation button.

NOTE: Operate the button while backlight is illuminated. When one indoor unit is controlled by two remote controllers (main/sub) only the first controller to be accessed by the user will illuminate its backlight.

6. OPERATION PROCEDURE

Read the operation manual that came with the remote controller:

- To protect the unit, turn on the main power switch 6 hours before operation.
- If the main power supply is turned off during operation, operation will restart automatically after the power turns back on again.

Part Name and Functions

In case of vertical position:

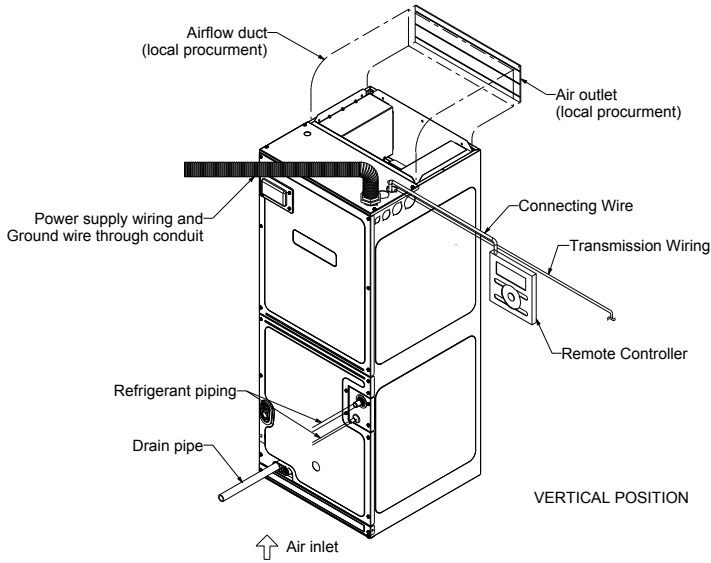

Figure 2

In case of horizontal position:

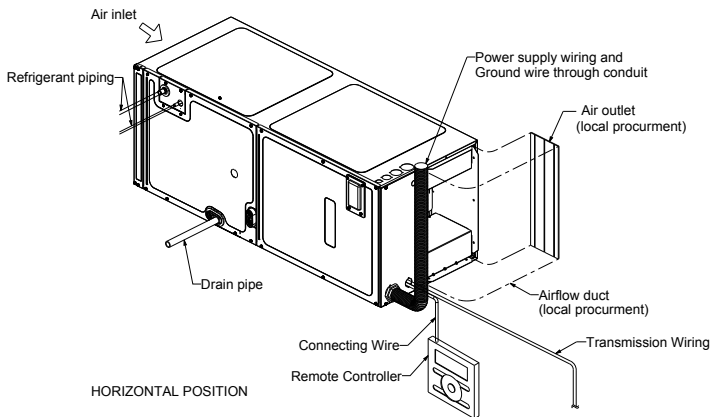
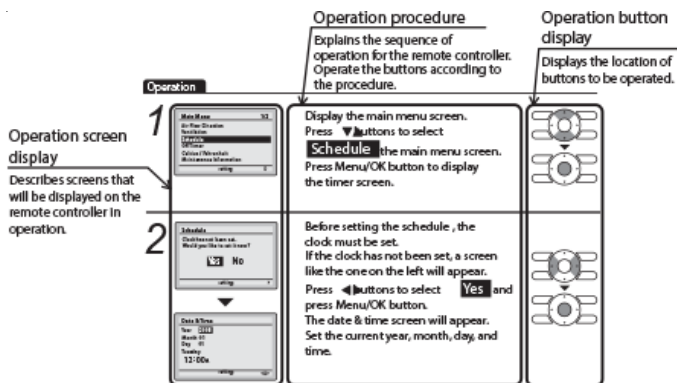

Figure 3

Basic Operation

COOL/HEAT/AUTO/FAN OPERATION

How to follow the operation manual:



Preparation:

- For mechanical protection purposes, apply power to the outdoor units at least six hours before starting the operation of the system.

Operation

- Press the Operation mode selector button several times until the desired mode Cool, Heat, Fan, or Auto mode is selected. (Unavailable operation modes are not displayed.)

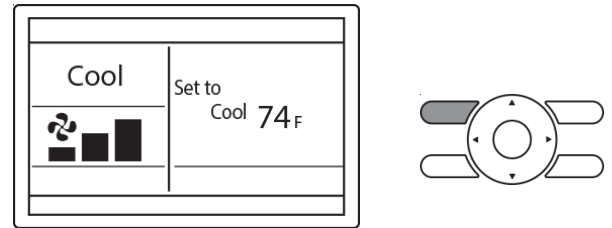

NOTE: Before changing the mode, confirm that the display does not indicate master controlled status. Both heat and cool mode may not be selected if the unit is master controlled.

- Press On/Off button. The Operation lamp (green) will illuminate and the system will start operating.

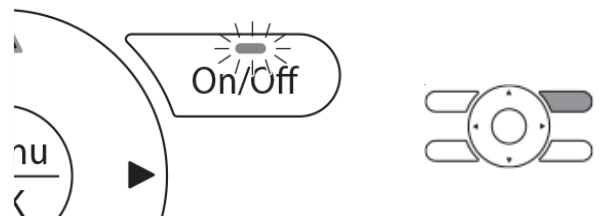

- The setpoint will increase by 1°F (or 1°C) when the Up Button is pressed and decrease by 1°F (or 1°C) when the Down Button is pressed. Setpoint is not available in fan or dry mode.

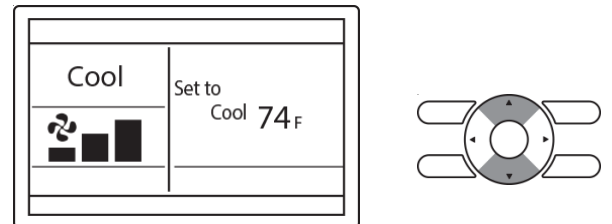

4. To change the fan speed, press the Fan speed control button and select the desired fan speed from Low, Medium, or High.
 - Only two fan speed adjustment levels, low and high may be available depending on the type of Indoor unit.
 - The system may be in automatic fan speed control for equipment protection purposes.
 - The system may be in automatic fan speed control according to the room temperature. It is normal for the fan to intermittently stop operating.
 - It is normal for a delay to occur when changing the fan speed.

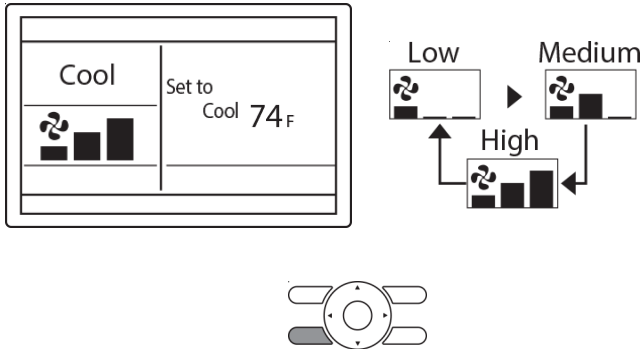

5. Adjust Air Flow Direction from the Main Menu.
 - If the connected indoor unit model does not include oscillating louvers this function will not be available.
6. When the On/Off Button is pressed again, the system will stop operating and the operation lamp will turn off.
 - When the system is stopped while in the heating mode, the fan will continue to operate for approximately one minute to remove residual heat from the indoor unit.

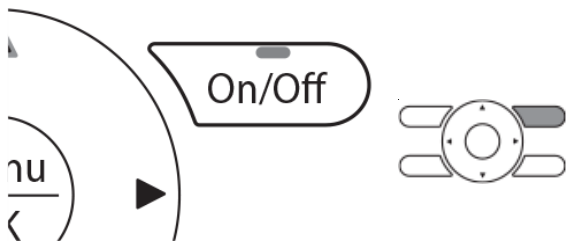

NOTE: To prevent water damage or system failure, do not immediately remove power from the indoor unit following system operation. Wait at least five minutes for the condensate pump to finish draining residual water from the unit.

CHARACTERISTICS OF HEAT MODE

The system automatically controls the following operating modes to prevent the reduction of heating capacity and space comfort.

Defrost Operation

- The system will automatically go into defrost operation to prevent frost accumulation at the outdoor unit and loss of heating capacity.
- The indoor unit fan will stop, and “**STANDBY**” (Defrost/Hot Start) will be displayed on the remote controller.
- The system will return to normal operation usually within six to eight minutes (but not more than 10 minutes).

Hot Start

- When the system goes into heat mode, the indoor unit fan will stop in order to prevent a cold draft. (In that case, “**STANDBY**” (Defrost/Hot Start) will be displayed on the remote controller).

DRY MODE

Preparation

- For equipment protection purposes, apply power to the outdoor units at least six hours before “starting the operation of the system.”
- The dry mode may not be selected if the remote controller is master controlled and the system is not already in the cooling mode of operation.

Operation

1. Press Mode Button several times until the Dry mode is selected. (The Dry mode may not be available depending on the type of indoor unit.)

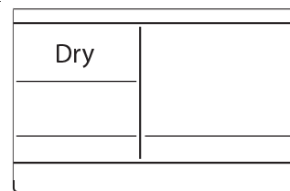

2. Press On/Off Button. The Operation Lamp (green) will illuminate and the system will start operating. In Dry Mode, the system maintains automatic temperature and fan speed control. Therefore, temperature setpoint or fan speed settings are not available while the indoor unit is in the Dry Mode.

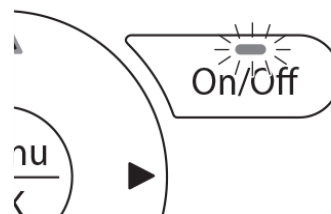

3. Adjust Air Flow Direction from the Main Menu.
 - If the connected indoor unit model does not include oscillating louvers this function will not be available.
4. When the On/Off Button is pressed again, the system will stop operating and the operation lamp will turn off.

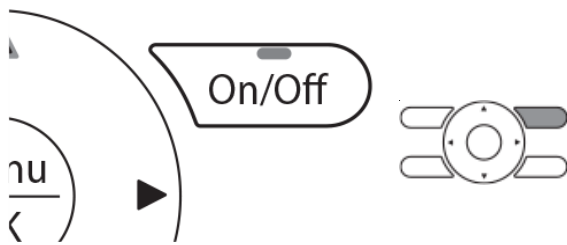

NOTE: To prevent water damage or system failure, do not immediately remove power from the indoor unit following system operation. Wait at least five minutes for the condensate pump to finish draining residual water from the unit.

CHARACTERISTIC OF DRY MODE

The Dry Mode dehumidifies the space at reduced cooling capacity to prevent the room temperature from dropping to uncomfortable levels.

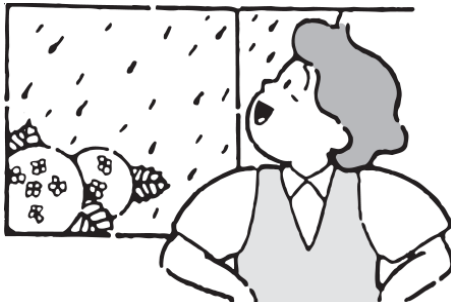

7. OPTIMUM OPERATION

Observe the following precautions to ensure the system operates:

- Adjust the room temperature properly for a comfortable environment. Avoid excessive heating or cooling.
- Prevent direct sunlight from entering a room during cooling operation by using curtains or blinds. Ventilate the room regularly. Using the unit for long periods of time requires attentive ventilation of the room.
- Keep doors and windows closed. If the doors and windows remain open, air will escape and diminish cooling or heating operation.
- Never place objects near the air inlet and the air outlet of the unit. It may cause deterioration in the effect or stop in the operation.
- Turn off the main power supply switch when it is not used for long periods of time. When the main power switch is turned on, some watts of electricity is being used even if the system is not operating. Turn off the main power supply switch for saving energy. When reoperating, turn on the main power supply switch 6 hours before operation for smooth running (Refer to MAINTENANCE).

- When the display shows "Time to clean filter", ask a qualified service person to clean the filters (Refer to MAINTENANCE).

8. MAINTENANCE (FOR SERVICE PERSONNEL)

⚠ WARNING

- **Only a qualified person is allowed to perform maintenance without daily maintenance.**
- **Before touching any of the connection wirings, be sure to turn off all power supply switches.**
- **For installation of optional parts, only a qualified person is allowed to do so.**

Be sure to use optional parts specified by the manufacturer. Installation in your own manner may result in water leakage, electric shock or fire.

- Do not use flammable material (e.g. hair-spray or insecticide) near the product.

⚠ CAUTION

- Only proceed with the unit cleaning after stopping the operation and turning the power supply off. Failure to do so may result in electric shocks or injury.
- **Do not wash the heat pump or air handler with water.** Failure to do so may result in an electric shock.
- **Consult with installation contractor for cleaning the inside of the air handler.** Wrong cleaning procedures may break plastic parts or cause water leakage or electric shock.
- **Use a stable prep stand.** Pay extra attention when cleaning the air handler.

Maintenance and Inspection

- Clean the drain pan periodically. The drain pipes clogged with dust will cause water leakage.
- For cleaning, consult with your Daikin dealer. (Before each season when cooling or heating is required, clean the air conditioner or heat pump.)
- If the area around the indoor unit is very dusty, use a dust proof cover (local procurement).

Cleaning the Inside of the Indoor Unit

- It is necessary to clean the inside of the indoor unit periodically.
- Since the cleaning requires special technologies, request a Daikin dealer to clean them.

Daily Maintenance (Cleaning the Air Filter)

- The air filter is field supply.

EXPLANATION:

- Removing the air filter except when cleaning the air conditioner or heat pump may result in accidents.
- When it is time to clean or replace the filter, the “Time to Clean Filter” message will appear on the bottom of the basic screen.

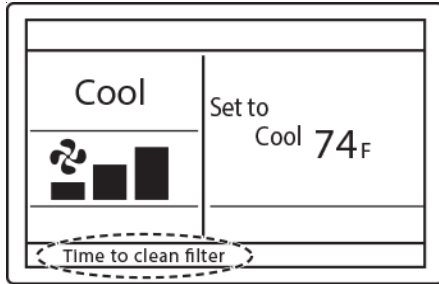

- Wash, clean, or replace the filter or element.
- If using the air conditioner or heat pump under a very dusty environment, increase the frequency of air filter cleaning.
- Consult a dealer to change filter setting time to display filter change alarm on remote controller screen. (The default factory setting is 2500 hours.)
- There are the following time display patterns: 1250, 2500, 5000, 10000.
- Air filter is field supply. In the time to clean filter and how to clean, please refer to the attached manual.

HOW TO CLEAN THE AIR FILTER

1. Remove the air filter.

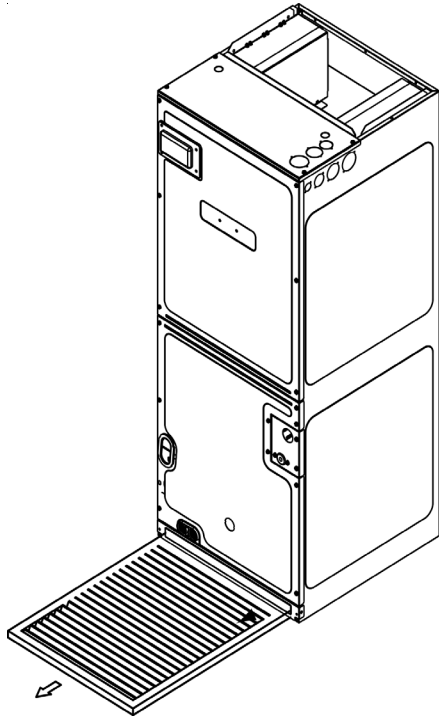

2. Clean the air filter. Please refer to attached manual. (Air filter is field supply.) Use a vacuum cleaner (A) or wash the air filter with water (B).

- A) Using a vacuum cleaner



- B) Washing With Water - When the air filter is very dirty, use soft brush and neutral detergent. Remove water and dry in the shade.



NOTE: Do NOT wash the air filter with hot water. Doing so may result in discoloration and/or deformation.

NOTE: Do NOT expose air filter to fire. Doing so may result in burning.

3. Attach the air filter.

- Once cleaning is done, be sure to replace the air filter as it was.
- Reset the filter indicator when the filter is cleaned or replaced.
- Press Menu/OK button. The Main Menu screen will appear.

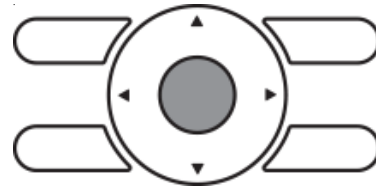

4. Push the “Filter Sign Reset” button on the remote controller.

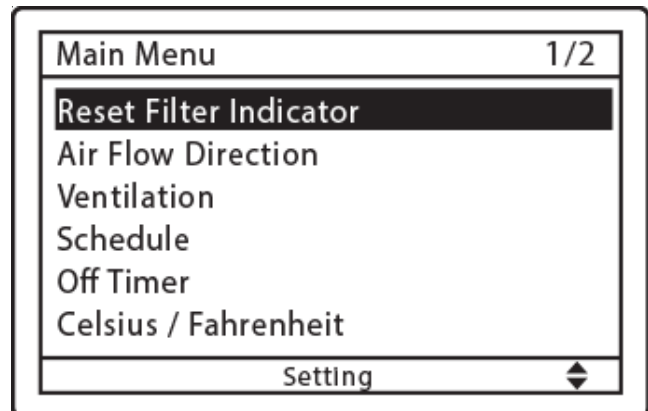

- Press the Up/Down buttons to select “Reset Filter Indicator” on the Main Menu screen and press the Menu/Enter button.

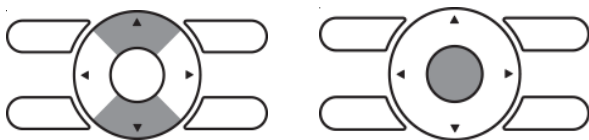

- The display shown in the illustration will disappear from the basic screen when the filter sign is reset.

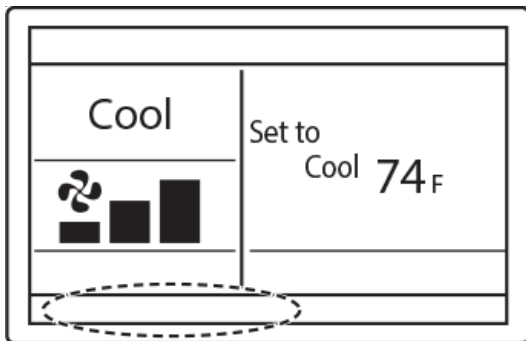

START UP AFTER A LONG STOP

1. Confirm the following:
 - Check that the air inlet and outlet are not blocked.
 - Remove any obstacle
 - Check if the ground is connected. Might there be a broken wire somewhere?
 - Contact a dealer if there are any problems.
2. Clean the air filter.
 - After cleaning the air filter, make sure to attach it.
3. Turn on the main power supply switch
 - The display on the remote controller will be shown when the power is turned on.
 - To protect the unit, turn on the main power switch at least 6 hours before operation.

WHAT TO DO WHEN STOPPING THE SYSTEM FOR A LONG PERIOD

1. Turn on FAN OPERATION for a half day and dry the unit.
 - Read the operation manual that came with the remote controller.
2. Shut off the power supply.
 - When the main power switch is shut on, some watts of electricity is being used even if the system is not operating.
 - Turn off the main power supply switch for saving energy.
 - The display on the remote controller will vanish when the main power switch is turned off.

3. Clean the air filter and the exterior.
 - Be sure to replace the air filter to its original place after cleaning. Refer to “HOW TO CLEAN THE AIR FILTER.”

ELECTRICAL HEATER REPLACEMENT INTERVAL

- **The electric heater should be replaced every 10 years.**
- This replacement interval is a guideline for ensuring safe and trouble-free operation of the product for many years.

9. MALFUNCTIONS NOT RELATED TO HEAT PUMP

The following symptoms do not indicate heat pump malfunction:

I. THE SYSTEM DOES NOT OPERATE

- **The system does not restart immediately after the ON/OFF button is pressed.** If the OPERATION lamp lights, the system is in normal condition. It does not restart immediately because a safety device operates to prevent overload of the system. After 3 minutes, the system will turn on again automatically.
- **The system does not restart immediately when TEMPERATURE SETTING button is returned to the former position after pushing the button.** If the OPERATION lamp lights, the system is in normal condition. It does not restart immediately because a safety device operates to prevent overload of the system. After 3 minutes, the system will turn on again automatically.
- **The system does not start when the display shows “CENTRAL CONTROL” and it flashes for few seconds after pressing an operation button.** This is because the system is under centralized control. Flashes on the display indicate that the system cannot be controlled by the remote controller.

- **The system does not start immediately after the power supply is turned on.** Wait one minute until the micro computer is prepared for operation.

II. The fan speed is different from the setting.

- **Pressing the fan speed control button does not change the fan speed.**
- When the room temperature reaches the set temperature in heating mode, the outdoor unit stops and the indoor unit switches to whisper mode. This is to prevent the cool air from being blown directly onto anyone in the room.
- To protect electric parts, the unit operates with the airflow rate at H speed during ELECTRIC HEATER operation regardless of the remote controller indication.

III. WHITE MIST COMES OUT OF A UNIT

- **When humidity is high during cooling operation (In oily or dusty places)** If the inside of an indoor unit is extremely contaminated, the temperature distribution inside a room becomes uneven. It is necessary to clean the inside of the indoor unit. Ask your Daikin dealer for details on cleaning the unit. This operation requires a qualified service person.

- **When the system is changed over to HEATING OPERATION after DEFROST OPERATION.** Moisture generated by DEFROST becomes steam.

IV. NOISE OF HEAT PUMP

- **A ringing sound after the unit is started.** This sound is generated by the temperature regulator working. It will quiet down after about a minute.
- **A continuous "Whoosh" is heard when the system is in COOLING or DEFROST OPERATION.** This is the sound of refrigerant gas flowing through both indoor and outdoor units.
- **A "Whoosh" sound is heard at the start or immediately after the stop of operation and at the start or immediately after the stop of DEFROST OPERATION.** This is the noise of refrigerant caused by flow stop and flow change.
- **A continuous flow "Whoosh" sound is heard when the system is in COOLING OPERATION or at a stop.** The noise is heard when the drain pump is in operation.

V. DUST FROM THE UNITS

- **Dust may blow out from the unit after starting operation after not being used for a while.** Dust absorbed by the unit blows out.

VI. THE UNITS GIVE OFF ODORS

- The unit absorbs the smell of rooms, furniture, cigarettes, etc., and then emits them.

VII. THE LIQUID CRYSTAL OF THE REMOTE CONTROLLER DISPLAY "Checking the connection. Please stand by"

- **This occurs immediately after the main power supply switch is turned on.** This indicates that the remote controller is in normal condition and continues temporarily.

10. TROUBLE SHOOTING

- I. **If one of the following malfunctions occurs, take the measures shown below and contact your Daikin dealer.**

The system must be repaired by a qualified service person.

WARNING

If the air conditioner or heat pump is operating abnormally, such as a burning smell, unplug the power cord from the outlet, and contact your dealer.

Continued operation under such circumstances may result in a failure, electric shock, and fire.

- If a safety device such as a fuse, a breaker or an ground leakage breaker frequently actuates:
Procedure: Do not turn on the main power switch, take the following actions.
- If the ON/OFF switch does not properly work:
Procedure: Turn off the main power switch

- If water leaks from unit:
Procedure: Stop the operation.
- If an error occurs, either one of the following items will flash in the basic screen.

"Error: Push Menu button" - The operation lamp will flash.

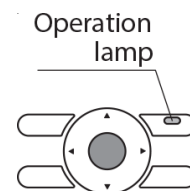
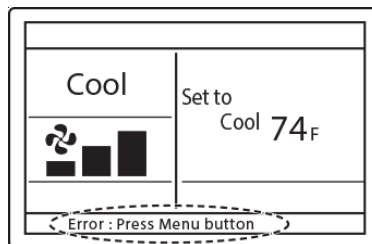

"Warning: Push Menu button" - The operation lamp will not flash.

- Press Menu/OK button.
- The error code will flash and the service contact and model name or code may appear.
- Notify your Daikin dealer of the Error code and model name or code.

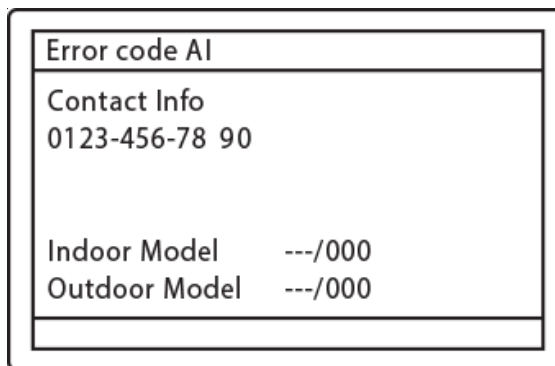

- II. **If the system does not properly operate (except for the above mentioned case), and none of the other mentioned malfunctions are evident, investigate the system according to the following procedures:**

1. If the system does not operate at all.
 - Check if there is a power failure. Wait until power is restored. If a power failure occurs during operation, the system automatically restarts immediately after the power supply recovers.
 - Check if a fuse has blown. Turn off the power supply.

- Check if the breaker is blown. Turn the power on with the breaker switch in the off position. Do not turn the power on with the breaker switch in the trip position. (Contact your dealer.)

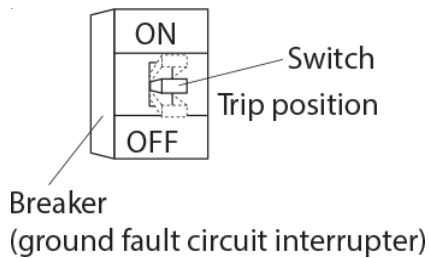

2. If the system stops operating it has been running normally.

- Check if the air inlet or outlet of outdoor or indoor unit is blocked by obstacles. Remove the obstacle so that it is well-ventilated.
- Check if the air filter is clogged. Ask a qualified service person to clean the air filters (Refer to HOW TO CLEAN THE AIR FILTER).

3. If the system operates but it does not sufficiently cool or heat, check if:

- If the air inlet or outlet of the indoor or the outdoor unit is blocked with obstacles. Remove the obstacle to ensure it is well-ventilated.
- If the air filter is clogged. Ask a qualified service person to clean the air filters (Refer to HOW TO CLEAN THE AIR FILTER).
- If the set temperature is not proper (Refer to ADJUSTMENT).
- If the FAN SPEED button is set to LOW SPEED (Refer to ADJUSTMENT).
- If the doors or the windows are open. Shut doors or windows to prevent wind from coming in.
- If direct sunlight enters the room (when cooling). Use curtains or blinds.
- When there are too many inhabitants in the room (when cooling). Cooling effect decreases if heat gain of the room is too large.
- The heat source of the room is excessive (when cooling). Cooling effect decreases if heat gain of the room is too large.

THIS PAGE IS INTENTIONALLY LEFT BLANK

THIS PAGE IS INTENTIONALLY LEFT BLANK

AIR HANDLER

AIR HANDLER HOMEOWNER'S ROUTINE MAINTENANCE RECOMMENDATIONS

We strongly recommend a bi-annual maintenance checkup be performed before the heating and cooling seasons begin by a qualified servicer.

REPLACE OR CLEAN FILTER

IMPORTANT NOTE: Never operate unit without a filter installed as dust and lint will build up on internal parts resulting in loss of efficiency, equipment damage and possible fire.

An indoor air filter must be used with your comfort system. A properly maintained filter will keep the indoor coil of your comfort system clean. A dirty coil could cause poor operation and/or severe equipment damage.

Your air filter or filters could be located in your furnace, in a blower unit, or in "filter grilles" in your ceiling or walls. The installer of your air conditioner or heat pump can tell you where your filter(s) are, and how to clean or replace them.

Check your filter(s) at least once a month. When they are dirty, replace or clean as required. Disposable type filters should be replaced. Reusable type filters may be cleaned.

You may want to ask your dealer about high efficiency filters. High efficiency filters are available in both electronic and non-electronic types. These filters can do a better job of catching small airborne particles.

MOTORS

Indoor and outdoor fan motors are permanently lubricated and do not require additional oiling.

ALUMINUM INDOOR COIL CLEANING (QUALIFIED SERVICER ONLY)

This unit is equipped with an aluminum tube evaporator coil. The safest way to clean the evaporator coil is to simply flush the coil with water. This cleaning practice remains as the recommended cleaning method for both copper tube and aluminum tube residential evaporator coils.

It has been determined that many coil cleaners and drain pan tablets contain corrosive chemicals that can be harmful to aluminum tube and fin evaporator coils. Even a one-time application of these corrosive chemicals can cause premature aluminum evaporator coil failure. Any cleaners that contain corrosive chemicals including, but not limited to, chlorine and hydroxides, should not be used.

An alternate cleaning method is to use one of the products listed in TP-109* to clean the coils. The cleaners listed are the only agents deemed safe and approved for use to clean round tube aluminum coils. TP-109 is also available on the web site in Partner Link > Service Toolkit.

NOTE: Ensure coils are rinsed well after use of any chemical cleaners.

BEFORE YOU CALL YOUR SERVICER

- Check the controller to confirm that it is properly set.
- Wait 15 minutes. Some devices in the outdoor unit or in programmable controllers will prevent compressor operation for awhile, and then reset automatically. Also, some power companies will install devices which shut off air conditioners for several minutes on hot days. If you wait several minutes, the unit may begin operation on its own.
- Check the electrical panel for tripped circuit breakers or failed fuses. Reset the circuit breakers or replace fuses as necessary.
- Check the disconnect switch near the indoor furnace or blower to confirm that it is closed.
- Check for obstructions on the outdoor unit. Confirm that it has not been covered on the sides or the top. Remove any obstruction that can be safely removed. If the unit is covered with dirt or debris, call a qualified servicer to clean it.
- Check for blockage of the indoor air inlets and outlets. Confirm that they are open and have not been blocked by objects (rugs, curtains or furniture).
- Check the filter. If it is dirty, clean or replace it.
- Listen for any unusual noise(s), other than normal operating noise, that might be coming from the outdoor unit. If you hear unusual noise(s) coming from the unit, call a qualified servicer.



WARNING

HIGH VOLTAGE!
DISCONNECT ALL POWER BEFORE SERVICING OR INSTALLING THIS UNIT. MULTIPLE POWER SOURCES MAY BE PRESENT. FAILURE TO DO SO MAY CAUSE PROPERTY DAMAGE, PERSONAL INJURY OR DEATH.



CAUTION

TO AVOID THE RISK OF EQUIPMENT DAMAGE OR FIRE, INSTALL THE SAME AMPERAGE BREAKER OR FUSE AS YOU ARE REPLACING. IF THE CIRCUIT BREAKER OR FUSE SHOULD OPEN AGAIN WITHIN THIRTY DAYS, CONTACT A QUALIFIED SERVICER TO CORRECT THE PROBLEM. IF YOU REPEATEDLY RESET THE BREAKER OR REPLACE THE FUSE WITHOUT HAVING THE PROBLEM CORRECTED, YOU RUN THE RISK OF SEVERE EQUIPMENT DAMAGE.