

Balancing Valves

TA SERIES 786/787/788/789 AND SERIES 78K

Tour & Andersson calibrated balancing valves offer a reliable, simple and cost effective way to measure and balance all flow rates. Full throttling range is achieved by 4, 8, 12, 16, 20 or 22 full turns of the handwheel, enabling a precise setting. This high degree of accurate adjustment means that the system can be balanced precisely.



The actual pressure drops in heating and cooling systems are difficult to establish by calculation because water flows vary from design flows. They can be corrected easily by regulating the desired water flow with Tour & Andersson globe style balancing valves. By measuring the pressure drop across measuring ports at a particular handwheel setting, the water flow for the valve size can be read easily from the appropriate pressure drop graph or flow balancing wheel. If the flow does not conform with that specified, adjust the valve and repeat the measuring procedure until the correct flow has been obtained.

NOTE: All Tour & Andersson balancing valves include a concealed memory feature with a locking tamper-proof setting.

Series 78K and TA Series 786 and 787 valves have an Ametal® body. Ametal is a copper alloy that eliminates the added expense of dielectric fittings.

TA Series 788 and 789 balancing valves have ductile iron bodies and Ametal or ductile iron trim, depending on size. Test ports feature self-sealing construction for insertion-type pressure or temperature probes.

All valves are rated from -4°F/-20°C to +250°F/+120°C. Service will also be governed by the connecting coupling gasket ratings for grooved and flanged valves.

Insulation kits are available for ½ – 6”/15 – 150mm sizes for Series 78K and TA Series 786, 787, 788 and 789 balancing valves.

TA Balancing valves provided by Victaulic can be ordered individually or as a component of the Series 799 or 79V KOIL-KIT Coil Pack. See the Series 799/79V Contractor Order Form (A) on page 9 of publication 08.30 for help ordering your Victaulic KOIL-KIT Coil Pack.

Victaulic KOIL-KIT Coil Packs provide a simplified, quality coil installation while ensuring optimal hydronic systems design requirements are met. The Series 799/79V is suitable for a variety of hot and cold water applications including treated and untreated water systems.

The Victaulic KOIL-KIT Coil Pack consists of the following components: Series 78Y Y-Strainer/Ball Valve or Series 78T Ball Valve Union Combination, two Coil Hoses, a Series 78U Union Port Fitting and a TA balancing valve. There are two options when ordering a Victaulic KOIL-KIT Coil Pack: Series 799 KOIL-KIT Coil Pack or Series 79V KOIL-KIT Coil Pack with ATC Valve.

The Series 799 and Series 79V comes standard with the components listed above. Additionally, the Series 79V includes the option to have the ATC valve of your choosing assembled and shipped with the Victaulic KOIL-KIT Coil Pack. Please note that when ordering a Series 79V, Victaulic offers one balancing valve, the Series 78K. Specify either Series 799 or Series 79V when ordering.

For added convenience, when coil hoses are ordered as a component of the Series 799 or 79V KOIL-KIT Coil Pack, all hoses can be provided pre-connected to the Series 78Y or 78T on the supply side and the Series 78U on the return side (specify connection preference when ordering).

For information on Victaulic KOIL-KIT Coil Packs, refer to publication 08.30.

VICTAULIC SERIES 799/79V KOIL-KIT™ COIL PACK

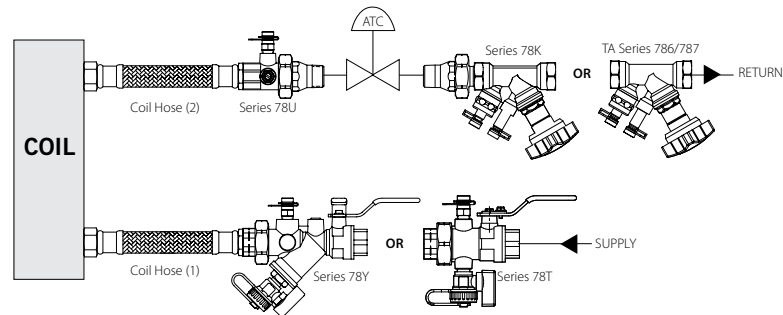

JOB/OWNER	CONTRACTOR	ENGINEER
System No. _____	Submitted By _____	Spec Sect _____ Para _____
Location _____	Date _____	Approved _____
		Date _____

Balancing Valves

TA SERIES 786/787/788/789 AND SERIES 78K

MATERIAL SPECIFICATIONS

Balancing Valves

BODY:

Series 78K and TA Series 786, 787: Ametal, (pressure die cast, nonporous copper alloy)
TA Series 788, 789: Ductile iron, ASTM A536 Grade 60-40-18 (BS Grade 400/15)

BODY COATING:

TA Series 788, 789: 2 ½, 3, 4" – Epoxy resin coated
 5-16" - painted

TRIM: (Bonnet, Stem and Restriction Cone)

Series 78K and TA Series 786, 787: Ametal

TA Series 788, 789:

Bonnet – 2 ½ – 6" – Ametal
 Bonnet – 8 – 16" – Ductile Iron
 Stem: Ametal
 Restriction Cone: Ametal

UNION:

Series 78K: Brass with EPDM o-ring

TAILPIECE & ADAPTER:

Series 78K: DZR Brass

SEAT:

Series 78K, and TA Series 786, 787: Ametal
TA Series 788, 789: Ductile Iron

SEAT SEAL:

Series 78K and TA Series, 786, 787, 788, 789: EPDM

STEM SEALS: EPDM

PROBE SEALS: EPDM

OPTIONAL SEAT, STEM AND PROBE SEALS: Fluoroelastomer (available on 1 ½ and 2" TA Series 787; 2 ½ – 10" TA Series 789 (except 5"). Contact Victaulic for availability.

HANDWHEEL:

Series 78K and TA Series 786, 787 – Red Polyamide plastic
TA Series 788, 789: 2 ½-6" – Red Polyamide plastic
 8-16" – Aluminum

OPTIONAL EQUIPMENT:

TA Series 786, 787: Drain kit-Ametal
TA Series 786, 787: Insulation Kit-Polyurethane. Also available on TA Series 789 2 ½-6" sizes.

Allen Wrench Sizes

3 mm memory ½ – 2" TA Series 786, 788 valves
 5 mm memory 2 ½ – 12" TA Series 788 & 2 ½ – 6" TA Series 789 valves
 8 mm memory 8 – 16" TA Series 789 valves
 5 mm drain kit ½ – 2" TA Series 786 valves

Balancing Valves

TA SERIES 786/787/788/789 AND SERIES 78K

COMPARISON OF BALANCING VALVE THROTTLING CHARACTERISTICS

- This curve illustrates the advantage of the four (4) turn adjustment available with Tour & Andersson balancing valves ($\frac{1}{2}$ – 2"/15 – 50 mm). Valves 2 $\frac{1}{2}$ "/65 mm and larger have 8, 12 or 16 turns.
- A 90° fully open to closed valve requires just a 12° change in adjustment to equal 30% change of the flow.
- A 360° fully open to closed valve would require 96° change in adjustment to equal the same 30% change in the flow measurement.
- Tour & Andersson balancing valves would require a 408° change in adjustment to equal the same 30% change in the flow.

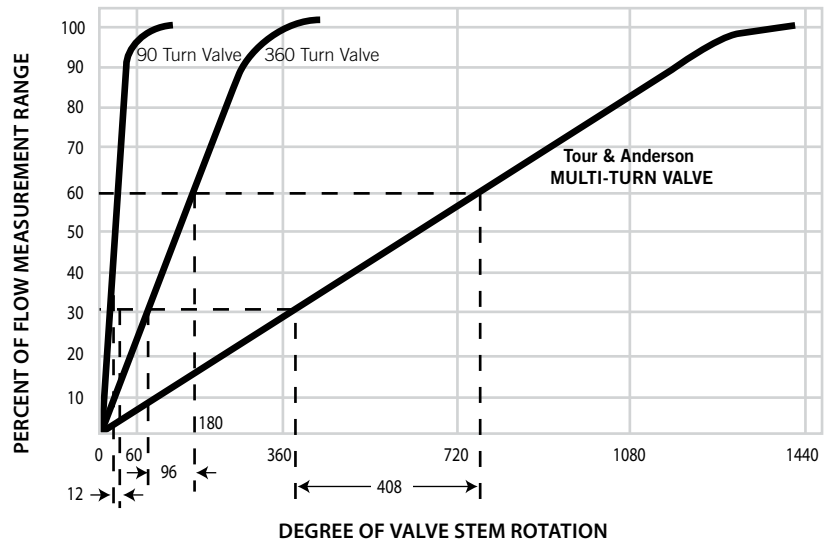

Balancing Valves

TA SERIES 786/787/788/789 AND SERIES 78K

Balancing Valve

TA SERIES 786 Solder End

TA SERIES 787 Female Threaded End

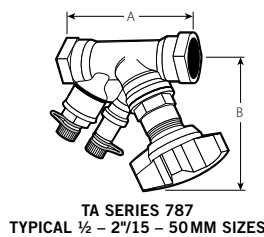
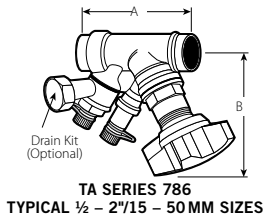

Size		TA Series 786 Solder End (300psi/2065 kPa) Balancing Valve			TA Series 787 NPT (Female) Threaded End (300psi/2065 kPa) Balancing Valve		
Nominal Size Inches/mm	Actual Outside Dia. Inches/mm	A End to End Inches/mm	B Center to Top Inches/mm	Approx. Weight Each Lbs./kg	A End to End Inches/mm	B Center to Top Inches/mm	Approx. Weight Each Lbs./kg
1/2 15	0.840 21.3	3.50 89	4.00 102	1.4 0.6	3.50 89	4.00 102	1.5 0.7
3/4 20	1.050 26.7	3.81 97	4.00 102	1.4 0.6	3.81 97	4.00 102	1.6 0.7
1 25	1.315 33.7	4.31 110	4.50 114	1.9 0.9	4.31 110	4.50 114	2.0 0.9
1 1/4 32	1.660 42.4	4.88 124	4.31 110	2.4 1.1	4.88 124	4.31 110	2.6 1.2
1 1/2 40	1.900 48.3	5.13 130	4.75 121	3.1 1.4	5.13 130	4.75 121	3.3 1.5
2 50	2.375 60.3	6.13 156	4.75 121	4.5 2.0	6.13 156	4.75 121	5.0 2.3

VALVE SELECTION GUIDE

Size		Flow Data for TA Series 786 & 787		
Nominal Size Inches/mm	Actual Outside Dia. Inches/mm	Absolute Min. Flow GPM/LPM	Nominal Range of Flow GPM/LPM	Absolute Max. Flow GPM/LPM
1/2 15	0.840 21.3	0.1 0.5	0.6 - 2.8 2.3 - 10.6	8.6 32.6
3/4 20	1.050 26.7	0.4 1.5	2.0 - 6.0 7.6 - 22.7	20.0 76.0
1 25	1.315 33.7	0.5 1.7	3.9 - 10.0 14.8 - 37.9	30.0 114.0
1 1/4 32	1.660 42.4	0.9 3.3	5.0 - 15.0 18.9 - 56.8	48.0 182.0
1 1/2 40	1.900 48.3	1.3 4.9	6.6 - 20.0 25.0 - 75.7	66.0 250.0
2 50	2.375 60.3	2.0 7.6	12.6 - 36.0 47.7 - 136.0	110.0 416.0

IMPORTANT NOTES:

Balancing valves should be sized in accordance with the GPM/LPM flows (and not in relation to pipeline size). Sizing balancing valves based on the minimum or maximum flow rates is not recommended. Valves should be sized using the nominal flow rate only. The Minimum Flow is calculated from the minimum open setting of the valve and a minimum pressure drop 1 Ft. WG (= 3 kPa). The Nominal Flow is calculated from the maximum open setting of the valve and the minimum recommended pressure drop, 2 Ft. WG (= 6 kPa). The Maximum Flow is calculated from the maximum open setting of the valve and the maximum pressure drop, 20 Ft. WG (= 60 kPa). A computer program, TA-Select, is available for calculation of valve handwheel pre-set position and other applications. Note: For information regarding Allen Wrench sizes see the Material Specifications section on page 2.

MEASURING ACCURACY:

The hand wheel zero position is calibrated and must not be changed. Valves have an accuracy of flow measurement of 2% to 3% when used within their recommended flow range and installed in accordance with the figure below. Note: For the most accurate results, a Series 734 TA SCOPE or Series 73M CMI should be used. However, any differential pressure meter may be used.

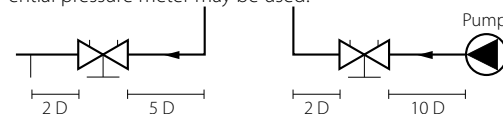

The illustration above relates to the accuracy of differential pressure measurement and is not an installation requirement.

Balancing Valves

TA SERIES 786/787/788/789 AND SERIES 78K

Balancing Valve

SERIES 78K Male x Female

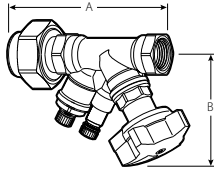

SERIES 78K
TYPICAL ½ - 2" / 15 - 50 MM SIZES

Optional tailpieces are available for double reductions, or for changing end configurations from sweat to threaded or threaded to sweat. If needed, specify tailpiece option when ordering.

Nominal Size Inches/mm		Series 78K Male x Female (300 psi / 2065 kpa) Balancing Valve				Approx. Weight Each Lbs./kg
MPT Union	FPT Valve	A End to End Inches/mm	A End to PermaLynx End Inches/mm	B Center to End Inches/mm		
½ 15	x ½ 15	5.75 146	6.76 172	4.00 102	1.7 0.8	
	x ¾ 20	5.94 151	-	4.00 102	1.8 0.8	
	x 1 25	6.27 159	-	4.50 114	2.7 1.2	
	x 1 ¼ 32	7.37 187	-	4.72 120	4.1 1.9	
¾ 20	x ¾ 20	5.99 152	7.97 202	4.00 102	2.3 1	
	x 1 25	6.81 173	-	4.50 114	2.2 1.0	
	x 1 ½ 40	7.66 195	-	4.75 121	5.0 2.3	
1 25	x 1 25	7.70 186	9.01 229	5.30 135	4.02 1.8	
	x 1 ¼ 32	7.83 199	-	4.31 109	2.8 1.3	
	x 1 ½ 40	7.66 195	-	4.75 121	5.2 2.4	
	x 2 50	8.91 226	-	4.75 121	7.3 3.3	
1 ¼ 32	x 1 ¼ 32	8.18 208	9.66 245	4.72 120	5.52 2.5	
	x 1 ½ 40	8.21 209	-	4.75 121	3.6 1.6	
	x 2 50	8.91 226	-	4.75 121	7.5 3.4	
1 ½ 40	x 1 ½ 40	9.00 229	10.37 263	4.75 121	7.16 3.2	
	x 2 50	9.02 229	-	4.75 121	5.3 2.4	
2 50	x 2 50	8.86 225	-	4.75 121	7.19 3.3	

Balancing Valves

TA SERIES 786/787/788/789 AND SERIES 78K

Balancing Valve

SERIES 78K Male x Female

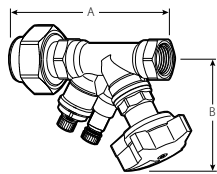

SERIES 78K
TYPICAL 1/2 - 2" / 15 - 50MM SIZES

VALVE SELECTION GUIDE

Size Nominal Size Inches/mm		Flow Data for Series 78K		
MPT Union	FPT Valve	Absolute Min Flow GPM LPM	Nominal Range of Flow GPM LPM	Absolute Max. Flow GPM LPM
1/2 15	x 1/2 15	0.1 05	0.6 - 2.8 2.3 - 10.6	8.6 32.6
	x 3/4 20	0.4 1.5	2.0 - 6.0 7.6 - 22.7	20.0 75.7
	x 1 25	0.5 1.7	3.9 - 10.0 14.8 - 37.9	30.0 114.0
	x 1 1/4 32	0.9 3.3	5.0 - 15.0 18.9 - 56.8	48.0 182.0
3/4 20	x 3/4 20	0.4 1.5	2.0 - 6.0 7.6 - 22.7	20.0 75.7
	x 1 25	0.5 1.7	3.9 - 10.0 14.8 - 37.9	30.0 114.0
	x 1 1/2 40	1.3 4.9	6.6 - 20.0 25.0 - 75.7	66.0 250.0
1 25	x 1 25	0.5 1.7	3.9 - 10.0 14.8 - 37.9	30.0 114.0
	x 1 1/4 32	0.9 3.3	5.0 - 15.0 18.9 - 56.8	48.0 182.0
	x 1 1/2 40	1.3 4.9	6.6 - 20.0 25.0 - 75.7	66.0 250.0
	x 2 50	2.0 7.6	12.6 - 36.0 47.7 - 136.0	110.0 416.0
1 1/4 32	x 1 1/4 32	0.9 3.3	5.0 - 15.0 18.9 - 56.8	48.0 182.0
	x 1 1/2 40	1.3 4.9	6.6 - 20.0 25.0 - 75.7	66.0 250.0
	x 2 50	2.0 7.6	12.6 - 36.0 47.7 - 136.0	110.0 416.0
1 1/2 40	x 1 1/2 40	1.3 4.9	6.6 - 20.0 25.0 - 75.7	66.0 250.0
	x 2 50	2.0 7.6	12.6 - 36.0 47.7 - 136.0	110.0 416.0
2 50	x 2 50	2.0 7.6	12.6 - 36.0 47.7 - 136.0	110.0 416.0

IMPORTANT NOTES: (SEE PAGE 4 FOR MEASURING ACCURACY)

Balancing valves should be sized in accordance with the GPM/LPM flows (and not in relation to pipeline size). Sizing balancing valves based on the minimum or maximum flow rates is not recommended. Valves should be sized using the nominal flow rate only. The Minimum Flow is calculated from the minimum open setting of the valve and a minimum pressure drop 1 Ft. WG (= 3 kPa). The Nominal Flow is calculated from the maximum open setting of the valve and the minimum recommended pressure drop, 2 Ft. WG (= 6 kPa). The Maximum Flow is calculated from the maximum open setting of the valve and the maximum pressure drop, 20 Ft. WG (= 60 kPa).

Note: A computer program, TA-Select, is available for calculation of valve handwheel pre-set position and other applications.

Note: For information regarding Allen Wrench sizes see the Material Specifications section on page 2.

Note: For the most accurate results, a Series 734 TA SCOPE or Series 73M CMI should be used. However, any differential pressure meter may be used.

Balancing Valves

TA SERIES 786/787/788/789 AND SERIES 78K

Balancing Valve

TA SERIES 788 Flanged End
(Class 150 RF, ASME/ANSI B16.42)
TA SERIES 789 Grooved End

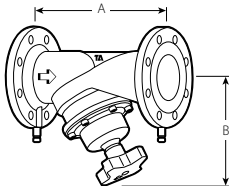

TA SERIES 788
TYPICAL 2½ – 16/65 – 400 MM SIZES

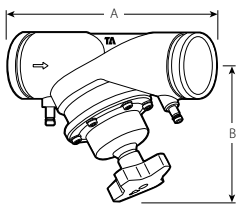

TA SERIES 789
TYPICAL 2½ – 12/65 – 300 MM SIZES

Size		TA Series 788 Flanged End (250 psi/1720 kPa) Balancing Valve			TA Series 789 Grooved End (350 psi/2400 kPa) Balancing Valve		
Nominal Size Inches mm	Actual Outside Dia. Inches mm	A End to End Inches mm	B Center to Top Inches mm	Approx. Weight Each Lbs. kg	A End to End Inches mm	B Center to Top Inches mm	Approx. Weight Each Lbs. kg
2½ 65	2.875 73.0	11.38 289	8.00 203	24.0 10.9	11.38 289	8.00 203	14.0 6.4
3 80	3.500 88.9	12.25 311	8.63 219	31.0 14.1	12.25 311	8.63 219	20.0 9.1
4 100	4.500 114.3	13.75 350	9.44 240	43.0 19.6	13.75 350	9.44 240	31.0 14.1
5 125	5.563 141.3	15.75 400	10.88 276	62.0 28.5	15.75 400	10.88 276	50.0 22.7
6 150	6.625 168.3	18.88 480	11.25 286	82.0 37.5	18.88 480	11.25 286	69.0 31.3
8 200	8.625 219.1	23.63 600	17.00 432	168.0 76.5	23.63 600	17.00 432	140.0 63.7
10 250	10.750 273.0	28.75 730	17.75 451	270.0 122.9	28.75 730	17.75 451	202.0 91.9
12 300	12.750 323.9	33.50 851	19.00 483	360.0 163.9	33.50 851	19.00 483	280.0 127.4
14 350	14.00 355.6	38.60 980	23.00 584	655 297	-	-	-
16 400	16.00 406.4	43.30 1100	25.20 640	895 406	-	-	-

VALVE SELECTION GUIDE

Size		Flow Data for TA Series 788 & 789		
Nominal Size Inches mm	Actual Outside Dia. Inches mm	Absolute Min Flow GPM LPM	Nominal Range of Flow GPM LPM	Absolute Max. Flow GPM LPM
2½ 65	2.875 73.0	1.4 5.3	38.0 – 100.0 144.0 – 379.0	290.0 1097.7
3 80	3.500 88.9	1.5 5.7	31.0 – 130.0 117.0 – 493.0	410.0 1551.9
4 100	4.500 114.3	1.9 7.2	68.0 – 200.0 257.0 – 757.0	650.0 2460.3
5 125	5.563 141.3	4.2 15.9	90.0 – 320.0 341.0 – 1211.0	1020.0 3860.7
6 150	6.625 168.3	5.0 18.9	182.0 – 450.0 689.0 – 1703.0	1430.0 5412.6
8 200	8.625 219.1	30.0 113.6	367.0 – 820.0 1389.0 – 3104.0	2600.0 9841.0
10 250	10.750 273.0	70.0 265.0	540.0 – 1300.0 2044.0 – 4921.0	4040.0 15291.4
12 300	12.750 323.9	115.0 435.3	960.0 – 1500.0 3634.0 – 5678.0	4950.0 18735.8
14 † 350	14.00 355.6	83.0 314.0	1020.0 – 2700.0 3861.0 – 10220.0	7414.0 28062.0
16 † 400	16.00 406.4	95.0 360.0	1330.0 – 3400.0 5034.0 – 12869.0	9371.0 35469.0

† Only the TA Series 788 Flanged End Balancing Valves is available in 14" and 16" (350 mm and 400 mm) sizes.

IMPORTANT NOTES: (SEE PAGE 4 FOR MEASURING ACCURACY)

Balancing valves should be sized in accordance with the GPM/LPM flows (and not in relation to pipeline size). Sizing balancing valves based on the minimum or maximum flow rates is not recommended. Valves should be sized using the nominal flow rate only. The Minimum Flow is calculated from the minimum open setting of the valve and a minimum pressure drop 1 Ft. WG (= 3 kPa). The Nominal Flow is calculated from the maximum open setting of the valve and the minimum recommended pressure drop, 2 Ft. WG (= 6 kPa). The Maximum Flow is calculated from the maximum open setting of the valve and the maximum pressure drop, 20 Ft. WG (= 60 kPa). A computer program, TA-Select, is available for calculation of valve handwheel pre-set position and other applications.

Note: For information regarding Allen Wrench sizes see the Material Specifications section on page 2.

Note: For the most accurate results, a Series 734 TA SCOPE or Series 73M CMI should be used. However, any differential pressure meter may be used.

Balancing Valves

TA SERIES 786/787/788/789 AND SERIES 78K



Link Differential Pressure Sensor

TA SERIES 736

- Provides connection between a building's heating and cooling and building's monitoring system (BMS).
- Continuously measures the flow and differential pressure through and across the Tour & Andersson balancing valves.
- Measurement probes provided for direct connection to the measurement points on all TA Series 786, 787, 788, and 789 balancing valves.



TA Select Computer Program

TA Select helps you choose the right balancing valve, taking the desired flow rate and pressure drop into consideration. The software will advise the correct combination of valve, handwheel position and pipe size to correctly balance the system. A sophisticated viscosity correction procedure displays the density, viscosity, specific heat and freezing point of fluids such as glycols and brines. It also displays the true value of flow through each valve.

The program will also size the pipe, generate Cv values for the ATC valves and give pre-set information for all TA valves on the project.



TA SCOPE

TA SERIES 734

- Series 734 TA SCOPE is an instrument designed to help professionals verify, measure and maintain complex systems quickly and efficiently, lowering maintenance costs by saving time and removing the hassle from the balancing and measuring process.
- Series 734 TA SCOPE is a wireless, handheld device for the swift and accurate measurement of differential pressure, flow, temperature and power.
- An independent sensor communicates with the TA SCOPE to deliver data quickly, thereby enabling contractors to balance a system, troubleshoot hydronic problems and log system performance.



CMI Pressure Differential Meter

TA SERIES 73M

TA CMI is a computer programmed measuring instrument. It is a handheld instrument for measuring differential pressure, temperature and flow through balancing valves in hydronic systems. It consists of a sensor unit and an instrument unit that has been programmed with the TA valve characteristics, which makes it possible to take a direct reading of flow and differential pressure.

Balancing Valves

TA SERIES 786/787/788/789 AND SERIES 78K

Drain Kit

SERIES 786-DK

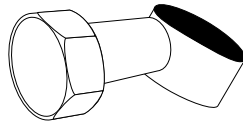

- A separate drain kit with a 3/4"/20mm connection is available for Series 786 and Series 787 valves
- Kit must be field mounted
- Kit comes complete with 2 gaskets and a hexnut.
- Partcode= K-000-786-CBV

Accessories

PROBE PORT

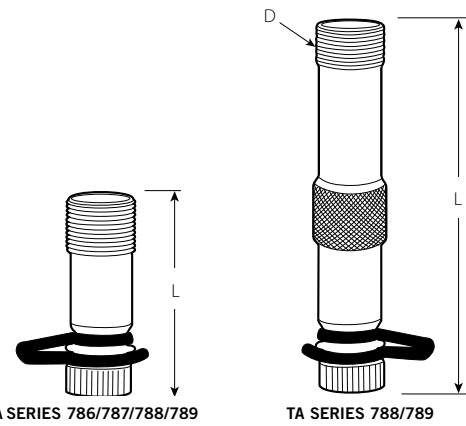

Style	Size	Part Code	Dimension		Part Code	Dimension		
			L Inches/mm	L Inches/mm		D Inches/mm	L Inches/mm	
786/787	1/2 - 2 15 - 50	—	—	K-000-740-003	1.75 45	—	—	
788/789	2 1/2 - 16 65 - 400	—	—	—	—	K-000-740-002	.38 10	1.19 30
788/789	2 1/2 - 16 65 - 400	—	—	—	—	K-000-740-001	.38 10	3.50 89

Balancing Valves

TA SERIES 786/787/788/789 AND SERIES 78K

UNIVERSAL GAUGE METER CONVERSION KIT

- This kit includes 2 probes, necessary fittings, flow wheel and instruction sheet.
- Partcode= K-000-738-100

HANDWHEELS

Part Code	Part Code	Part Code
P-004-784-001	P-024-784-001	P-080-784-001

BALANCING WHEEL



By using the balancing wheel it is easy to determine the relationship between flow, pressure drop and the handwheel setting values for all valve sizes. Order the balancing wheel from your nearest Victaulic representative.

Balancing Valves

TA SERIES 786/787/788/789 AND SERIES 78K

PREFAB INSULATION TA SERIES 786 & TA SERIES 787

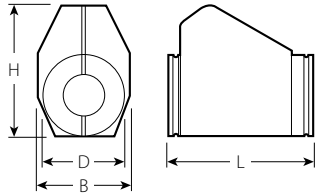

Valve Size		Dimensions Inches/mm			
Inches/mm	Part Code	H	D	B	L
½ & ¾ 15 & 20	K-004-784-INS	5.31 135	3.54 90	4.06 103	5.51 140
1 25	K-010-784-INS	5.59 142	3.70 94	4.06 103	6.30 160
1 ¼ 32	K-012-784-INS	6.14 156	4.17 106	4.06 103	7.09 180
1 ½ 40	K-014-784-INS	6.65 169	4.25 108	4.45 113	8.43 214
2 50	K-020-784-INS	7.01 178	4.25 108	4.49 114	9.65 245

PREFAB INSULATION TA SERIES 788 & TA SERIES 789

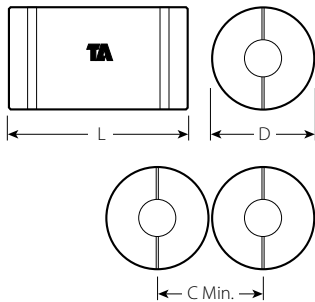

Valve Size		Dimensions Inches/mm		
Inches/mm	Part Code	H	D	B
2 ½ 65	K-024-784-INS	17.75 451	10.63 270	10.63 270
3 80	K-030-784-INS	19.00 483	11.44 291	11.44 291
4 100	K-040-784-INS	20.50 521	12.63 321	12.63 321
5 125	K-050-784-INS	22.50 572	13.75 349	13.75 349
6 150	K-060-784-INS	26.00 660	15.00 381	15.00 381

Balancing Valves

TA SERIES 786/787/788/789 AND SERIES 78K

TYPICAL SPECIFICATIONS

SERIES 78K – (½-2" M x F)

TA SERIES 786 STAS – (½ – 2" SOLDER WITH DIGITAL HANDWHEEL)

TA SERIES 787 STAD – (½ – 2" NPT)

Furnish and install, as shown on the job plans, TA Series 786/787 Balancing Valves with provision for connecting a portable differential (Ft. of Head) pressure meter. Each meter shall have pressure/temperature probes.

The balancing valves shall be Y-pattern globe style design and all metal parts of nonferrous, pressure die cast, nonporous Ametal. Each valve shall provide four (4) functions:

(1) Precise flow measurement, (2) Precision flow balancing, (3) Positive shut-off with no drip seat, eliminating the need of an additional isolation valve, (4) Drain connection using ¾" NPT hose end thread.

These valves shall have four (4) 360° adjustment turns of the handwheel for precise setting with hidden memory to provide a tamper-proof balancing setting. Handwheel shall have digital readout. The handwheel can be installed in any position without affecting performance.

TA SERIES 788 STAF – (2 ½ – 12" FLANGED WITH DIGITAL HAND WHEEL)

TA SERIES 789 STAG – (2 ½ – 12" GROOVED WITH DIGITAL HAND WHEEL)

Furnish and install, as shown on the job plans, TA Series 788/789 Balancing valves with provision for connecting a portable differential (Ft. of Head) pressure meter. Each meter connection shall have pressure/temperature probes.

The balancing valves shall be Y-pattern globe style design with ductile iron body all other wetted parts of nonferrous, pressure die cast Ametal. Each valve shall provide three (3) functions:

(1) Precision flow measurement, (2) Precision flow balancing, (3) Shut-off feature, eliminating the need of an additional isolation valve.

These valves shall have eight (8), twelve (12) or sixteen (16) 360° adjustment turns of the handwheel for precise setting with hidden memory feature to program the valve with precision tamper-proof balancing setting. Handwheel shall have digital readout. The handwheel can be installed in any position without affecting performance.

TA Balancing Valves ½" through 2": 300psi/2065kPa, y-pattern, globe type with soldered or threaded ends, non-ferrous Ametal® brass copper alloy body, EPDM o-ring seals. 4-turn digital readout handwheel for balancing, hidden memory feature with locking tamper-proof setting, and connections for portable differential meter. TA Series 786 STAS or 787 STAD.

TA Balancing Valves 2 ½" through 16": 300psi/2065kPa, y-pattern, globe type with flanged or grooved ends, ASTM A536 ductile iron body, all other metal parts of Ametal® brass copper alloy, EPDM O-ring seals. 8, 12, 16, 20 or 22 turn digital readout handwheel for balancing, hidden memory feature with locking tamper-proof setting, and connections for portable differential meter. TA Series 788 STAF or 789 STAG.

Purchased TA CBI-II or TA CMI balancing instruments are to be left with the project owner upon completion of the project.

Balancing Meter: If a balancing meter is required to be left with the owner after commissioning, the balancing meter shall be from the same provider as the balancing valves, Victaulic/Tour and Andersson. The Series 734 TA-Scope, or TA Series 73M CMI Pressure Differential Meter are acceptable and are manufactured by Tour and Andersson. Needle gauge type meters will not be allowed.

INSULATION:

For insulation against heat loss or condensation. Preformed rigid polyurethane insulation is available for ½ – 2" TA Series 786/787 valves and for 2 ½ – 6" TA Series 788/789 valves.

Balancing Valves

TA SERIES 786/787/788/789 AND SERIES 78K

CORRECTION FACTORS

For liquids other than water, the flow values from the balancing wheel can be adjusted as follows:
Divide the flow rate (as indicated by the balancing wheel) by the square root of the specific gravity.

$$\text{Actual Flow} = \frac{q_{CB}}{\sqrt{SG}}$$

This applies to liquids having, on the whole, the same viscosity as water, i.e. most water/glycol mixtures and water/brine solutions at room temperature. At low temperatures, the viscosity increases and laminar flow may occur in certain valves. The risk increases with small valves, low settings and low differential pressures.

A computer program (TA-Select) is available for calculation of pre-setting values and other applications. When the flow setting is verified or changed to the final setting, the memory stop should be set. Contact Victaulic for further information.

SIZING A BALANCING VALVE

When Δp and the design flow rate are known, use the formula shown to calculate the C_v value or use the graphs on page 16 – 18. The Tour & Andersson balancing wheel can also be used.

$$C_v = 1.52 \frac{q}{\sqrt{\Delta p}}$$

q in GPM, Δp in Ft. of H₂O

$$C_v = \frac{q}{\sqrt{\Delta p}}$$

q in GPM, Δp in psi

A computer program, TA-Select, is available from Victaulic for calculation of pre-setting values and other applications.

Balancing Valves

TA SERIES 786/787/788/789 AND SERIES 78K

**C_v VALUES FOR VARIOUS HANDLE SETTINGS
SERIES 78K
and TA SERIES 786/787**

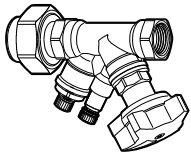

SERIES 78K

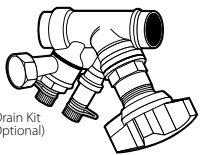

Drain Kit
(Optional)

TA SERIES 786

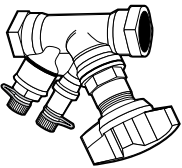

TA SERIES 787

The values below or the graph on page 15 may be used when calculating and sizing a piping system.

No. of Turns	C _v Values for Sizes listed below §					
	½"	¾"	1"	1 ¼"	1 ½"	2"
0.50	0.15	0.59	0.70	1.32	2.03	2.97
1.00	0.25	0.88	1.19	2.20	3.83	4.87
1.50	0.36	1.38	2.44	3.60	5.34	8.35
2.00	0.66	2.20	4.20	5.40	7.08	13.60
2.50	1.02	3.24	6.15	8.24	10.20	18.80
3.00	1.60	4.49	8.00	11.00	14.60	24.90
3.50	2.30	5.51	9.28	13.70	18.60	30.70
4.00 *	2.92	6.61	10.09	16.50	22.30	38.00

§ C_v = GPM at a ΔP of 1 psi/7 kPa) through the valve at any given setting.

1 psi = 2.31 ft. of H₂O.

*Full open valve.

Balancing Valves

TA SERIES 786/787/788/789 AND SERIES 78K

C_v VALUES FOR VARIOUS HANDLE SETTINGS TA SERIES 788/789

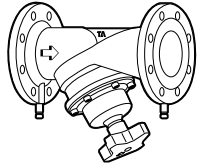

TA SERIES 788

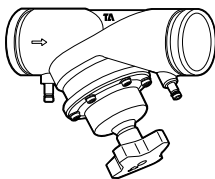

TA SERIES 789

The values below or the graph on page 16 and 17 may be used when calculating and sizing a piping system.

No. of Turns	C _v Values for Sizes listed below §									
	2½"	3"	4"	5"	6"	8"	10"	12"	14"	16"
0.50	2.09	2.32	2.90	6.38	7.54	—	—	—	—	—
1.00	3.94	4.64	6.96	12.20	13.90	—	—	—	—	—
1.50	5.68	6.96	10.40	18.00	25.50	—	—	—	—	—
2.00	7.54	9.28	13.30	24.90	46.40	46.40	104.00	—	—	—
2.50	10.80	12.80	18.60	31.30	75.40	58.00	128.00	—	—	—
3.00	18.90	16.20	30.20	41.80	116.00	75.40	162.00	174.00	124.87	143.20
3.50	29.70	22.60	51.00	63.80	157.00	104.00	226.00	267.00	147.78	169.55
4.00	40.90	33.60	73.10	96.30	196.00	139.00	296.00	348.00	169.55	195.50
4.50	51.60	47.60	92.80	132.00	240.00	191.00	371.00	429.00	194.76	238.29
5.00	60.30	63.80	114.00	164.00	281.00	261.00	447.00	522.00	237.14	302.44
5.50	70.20	78.90	133.00	194.00	324.00	331.00	516.00	621.00	290.99	373.47
6.00	78.90	92.80	153.00	229.00	362.00	394.00	580.00	719.00	345.98	442.21
6.50	84.70	107.00	168.00	255.00	394.00	464.00	632.00	800.00	403.26	514.38
7.00	89.30	119.00	184.00	289.00	426.00	505.00	684.00	870.00	462.83	589.99
7.50	93.40	131.00	203.00	320.00	454.00	545.00	766.00	945.00	539.59	675.92
8.00	98.60 *	139.00 *	220.00 *	348.00 *	487.00 *	597.00	841.00	1032.00	636.96	779.02
9.00	—	—	—	—	—	690.00	951.00	1125.00	898.17	1024.18
10.00	—	—	—	—	—	754.00	1090.00	1206.00	1096.36	1306.01
11.00	—	—	—	—	—	824.00	1218.00	1299.00	1260.18	1432.03
12.00	—	—	—	—	—	887.00 *	1375.00 *	1392.00	1443.48	1603.87
13.00	—	—	—	—	—	—	—	1531.00	1626.78	1787.17
14.00	—	—	—	—	—	—	—	1589.00	1844.45	1981.92
15.00	—	—	—	—	—	—	—	1624.00	2016.29	2222.50
16.00	—	—	—	—	—	—	—	1682.00 *	2142.31	2451.63
17.00	—	—	—	—	—	—	—	—	2245.42	2612.01
18.00	—	—	—	—	—	—	—	—	2337.06	2760.94
19.00	—	—	—	—	—	—	—	—	2440.17	2898.42
20.00	—	—	—	—	—	—	—	—	2520.36*	3012.98
21.00	—	—	—	—	—	—	—	—	—	3104.63
22.00	—	—	—	—	—	—	—	—	—	3184.82*

§ C_v = GPM at a ΔP of 1 psi/7 kPa) through the valve at any given setting.

1 psi = 2.31 ft. of H₂O.

*Full open valve.

Balancing Valves

TA SERIES 786/787/788/789 AND SERIES 78K

Diagram

TA SERIES 786/787 and SERIES 78K

This graph shows the pressure drop across the pressure test points of the valve.

A straight line connecting the bars for flow rate, C_v and pressure drop shows the relationship between these variables. The position for each valve size is arrived at by drawing a horizontal line from the C_v value obtained.

Example:

Wanted: Pre-setting for a 1" valve at a desired flow rate of 6.7GPM and a pressure drop of 3 ft.

Solution: Draw straight line joining 6.7GPM and 3 ft. This gives $C_v = 5.9$. Now draw a horizontal line from $C_v = 5.9$. This intersects the bar for a 1" valve at the desired pre-setting of 2.35 turns.

NOTE: If the flow rate falls outside of the scale in the diagram, the reading can be made as follows: Starting with the example above, we get 3 ft., $C_v = 5.9$ and the flow rate 6.7GPM. At 3 ft. and $C_v = .59$ we get the flow rate .67GPM. That is, for a given pressure drop, it is possible to read 10 times or 0.1 times the flow and C_v values.

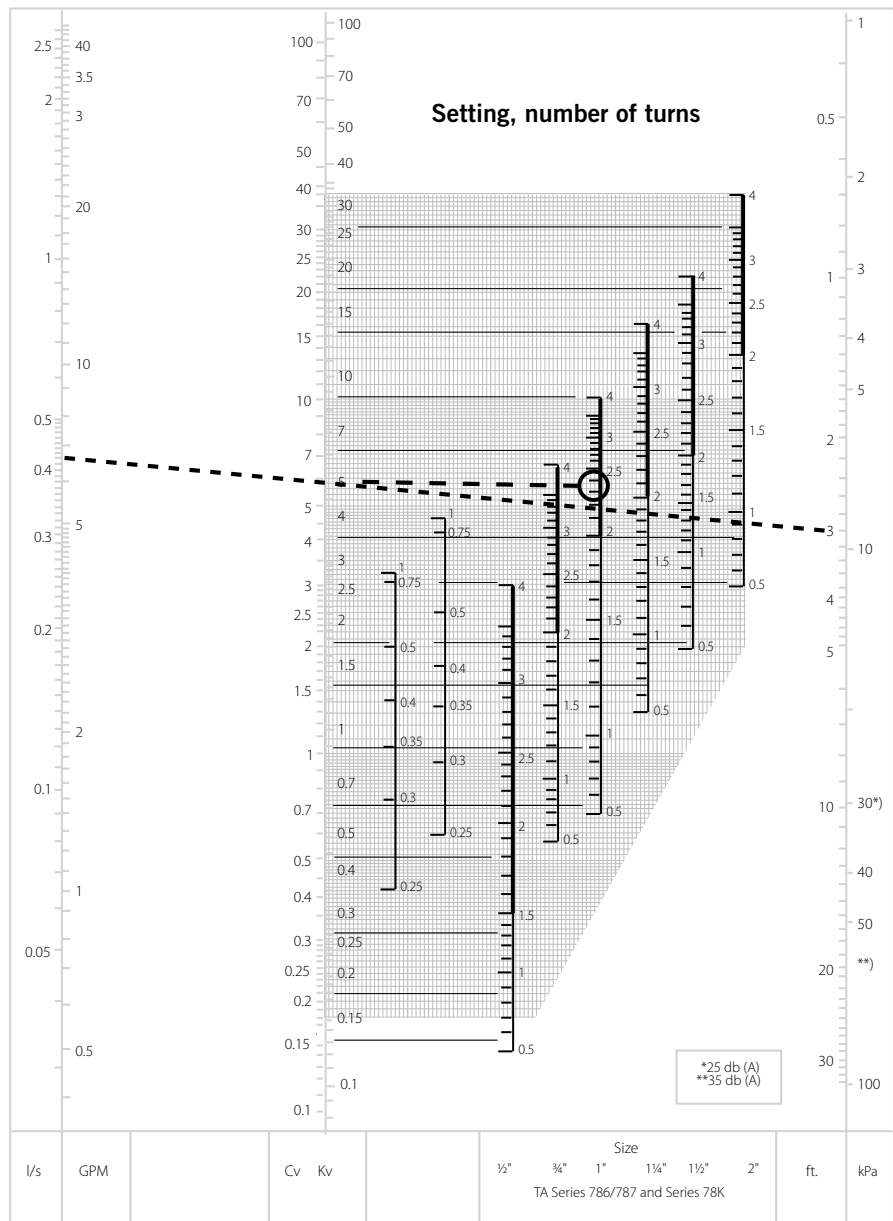

Balancing Valves

TA SERIES 786/787/788/789 AND SERIES 78K

Diagram

TA SERIES 788/789
SIZES 2½ – 6"/60-150 MM

This graph shows the pressure drop across the pressure test points of the valve.

A straight line connecting the flow rate scale, C_v and pressure drop shows the relationship between these variables

Example:

Wanted: Pre-setting for a TA Series 788 or TA Series 789 2½" at a desired flow rate of 47 GPM and a pressure drop of 2 ft. WG.

Solution: Draw straight line joining 47 GPM and 2 ft. WG. This gives $C_v = 50$. Now draw a horizontal line from $C_v = 50$. This intersects the flow rate scale for Series 788 2½" at the desired pre-setting of 4.5 turns.

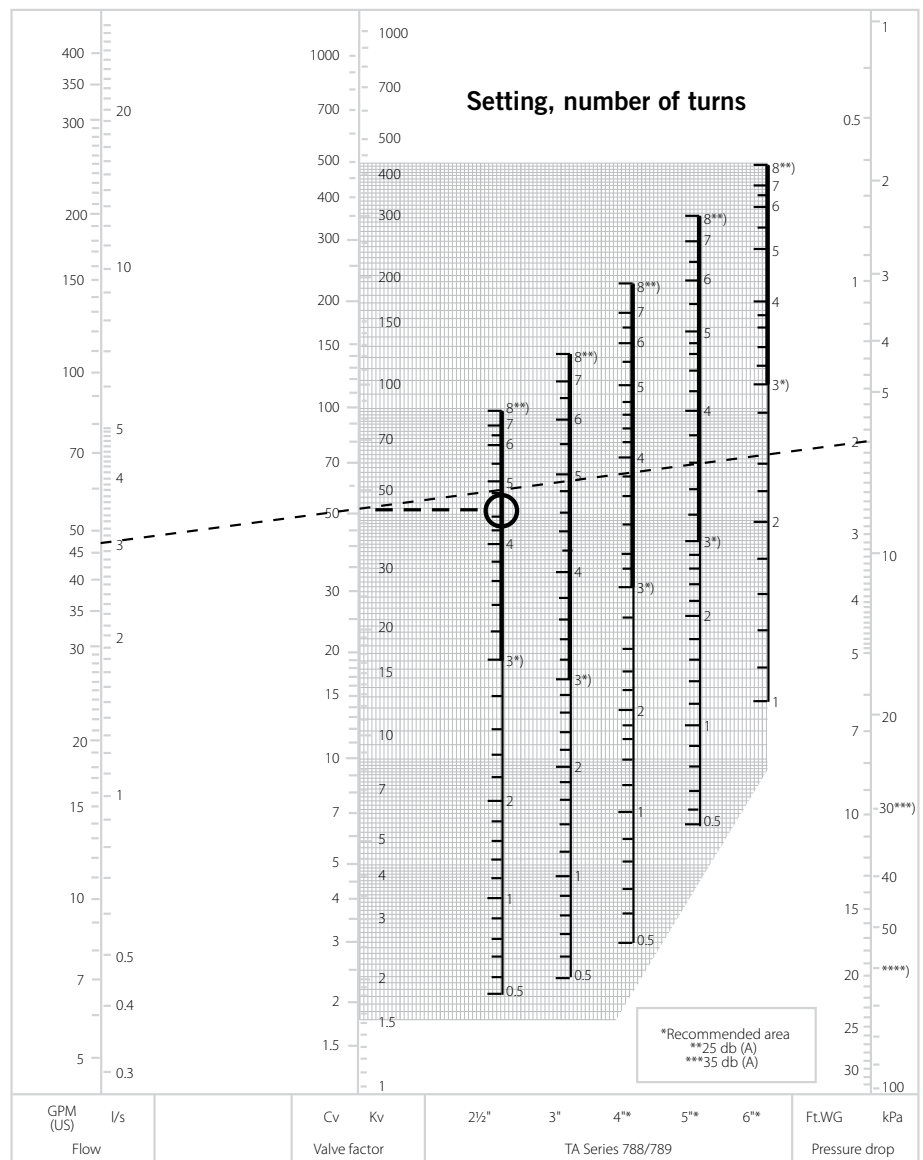

Balancing Valves

TA SERIES 786/787/788/789 AND SERIES 78K

Diagram

TA SERIES 788/789
SIZES 8-16"/200-400 MM

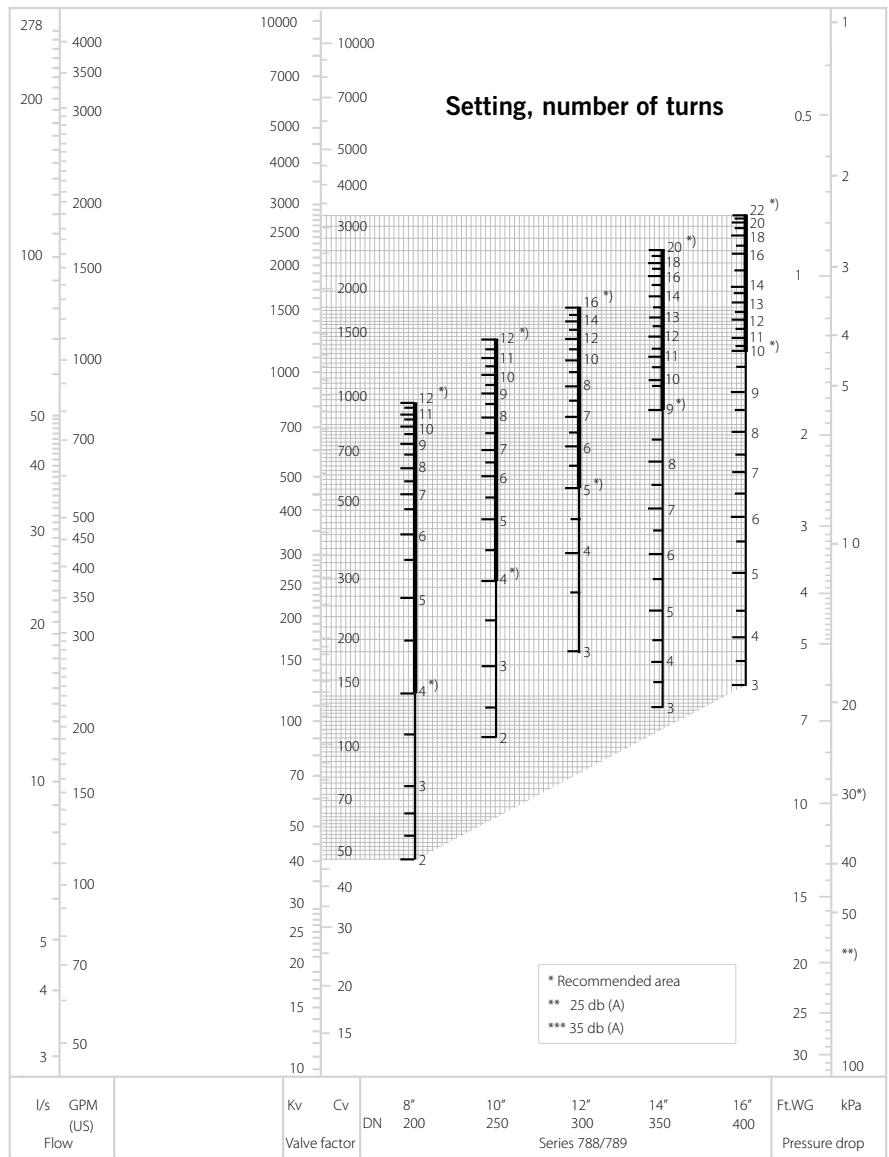

Balancing Valves

TA SERIES 786/787/788/789 AND SERIES 78K

WARRANTY

Refer to the Warranty section of the current Price List or contact Victaulic for details.

NOTE

This product shall be manufactured by Victaulic or to Victaulic specifications. All products to be installed in accordance with current Victaulic installation/assembly instructions as recommended by Tour and Andersson. Victaulic reserves the right to change product specifications, designs and standard equipment without notice and without incurring obligations.

For complete contact information, visit www.victaulic.com

08.16 0930 REV O UPDATED 2/2011

VICTAULIC IS A REGISTERED TRADEMARK OF VICTAULIC COMPANY. © 2011 VICTAULIC COMPANY. ALL RIGHTS RESERVED.

08.16

