

Models/Modelos/Modèles

581LF-PP
 581LF-HGM-PP
 581LF-GPM-PP
 581LF-MPU-PP
 Series/Series/Seria

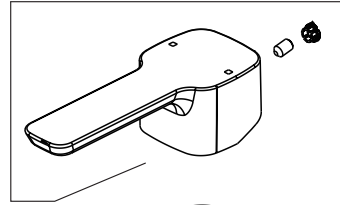

RP92090▲
 Handle Assembly
 Montage de la manette
 Conjunto de manija

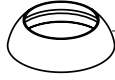

RP91963▲
 Cap
 Embase
 Casquillo

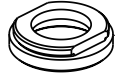

RP91507
 Bonnet Nut & Cartridge
 Écrou de chapeau et Cartouche
 Tuerca bonete y Cartucho



RP78360▲
 Lift rod plug - (Optional, not included)
 Tapón de la barra de elevación - (Opcional, no incluido)
 Prise du levier de soulèvement - (Option, non inclus)



RP71081▲
 Lift Rod Assembly
 Barra de Alzar
 Tige de Manoeuvre

▲ Specify Finish
 Especifique el acabado
 Précisez la Finition

RP91237
 (For 581LF-PP &
 581LF-MPU-PP)
 1.2 GPM (4.5 L/min)
 Aerator
 Aérateur
 Aireador

RP91238
 (For 581LF-GPM-PP)
 1.0 GPM (3.8 L/min)
 Aerator
 Aérateur
 Aireador

RP91239
 (For 581LF-HGM-PP)
 0.5 GPM (1.9 L/min)
 Aerator
 Aérateur
 Aireador

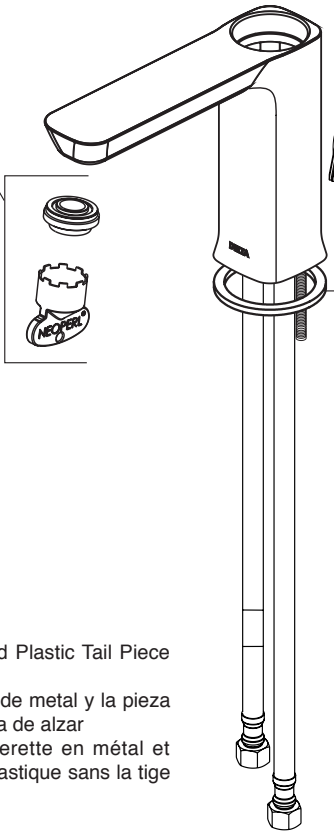

RP40783
 Gasket
 Joint
 Junta

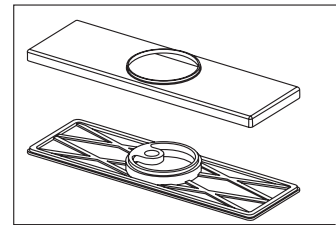

RP76702▲
 Escutcheon with gasket (3 Hole) - (Optional, not included)
 Boîtier et joint (3 trous) - (Opcional, no incluido)
 Chapetón y empaque (3 agujeros) - (Option, non inclus)

RP38958▲
 Pop-Up with Metal Flange and Plastic Tail Piece
 Less Lift Rod
 Drenaje automático con brida de metal y la pieza
 de cola plástica menos la barra de alzar
 Renvoi mécanique avec collerette en métal et
 raccord droit de vidange en plastique sans la tige
 de manoeuvre

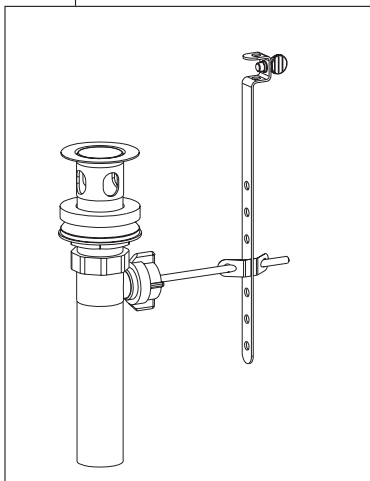

RP28653▲ (For 581LF-MPU-PP)
 Metal Pop-Up Assembly Less Lift Rod
 Ensemble de Metal del Desagüe Automático Sin la Barra de Alzar
 Renvoi mécanique en métal sans la tige de manoeuvre

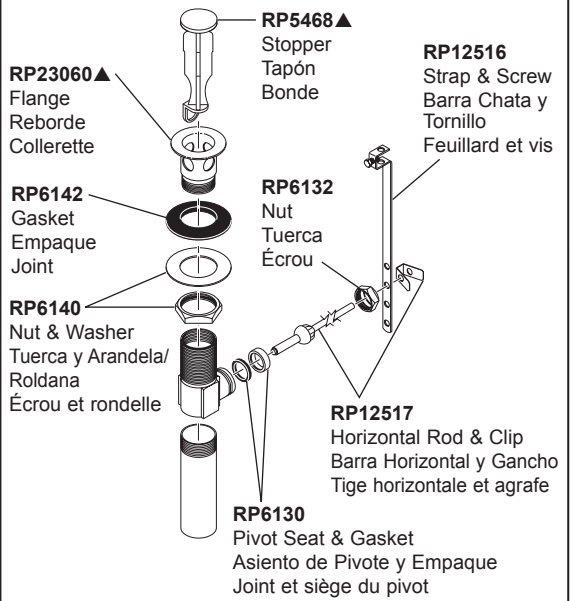

RP23060▲
 Flange
 Reborde
 Collerette

RP5468▲
 Stopper
 Tapón
 Bonde

RP12516
 Strap & Screw
 Barra Chata y
 Tornillo
 Feuillard et vis

RP6142
 Gasket
 Empaque
 Joint

RP6132
 Nut
 Tuerca
 Écrou

RP6140
 Nut & Washer
 Tuerca y Arandela/
 Roldana
 Écrou et rondelle

RP12517
 Horizontal Rod & Clip
 Barra Horizontal y Gancho
 Tige horizontale et agrafe

RP6130
 Pivot Seat & Gasket
 Asiento de Pivote y Empaque
 Joint et siège du pivot

RP72946
 Mounting Hardware
 Pièces de montage
 Herraje de instalación