



## Descriptions

Enables to control multiple air conditioners from a (remote) location by connecting the On/Off contact point. It can also control the operation of the relay with error signals by connecting the MA remote controller.

## Applicable Models

- MSZ-RW25,35,50VG
  - MSZ-LN18,25,35,50,60VG2W,V,R,B
  - MSZ-FT25,35,50VG
  - MSZ-AP15,20VG
  - MSZ-AP25,35,42,50,60,71VG
  - MSZ-EF18,22,25,35,42,50VGW,B,S
  - MSZ-BT20,25,35,50VG
  - MSZ-HR25,35,42,50,60,71VF
  - MSZ-DW25,35,50VF
  - MSY-TP35,50VF
  - MSZ-FH25,35,50VE2
  - MSZ-SF15,20VA
  - MSZ-SF25,35,42,50VE3
  - MSZ-GF60,71VE2
  - MSZ-WN25,35VA
  - MSZ-DM25,35VA
  - MFZ-KT25,35,50,60VG
  - MFZ-KW25,35,50,60VG
  - MLZ-KP25,35,50VF
  - S-series models
  - P-series models:
- In the case the outdoor unit is SUZ or MXZ,  
the indoor of P-series can be connected.
- (For grouping SUZ/MXZ outdoor units with P or S series indoor units, interface is required)

## Specifications

Power	12V DC (supplied from indoor unit)	
Operating conditions	Indoor only (ambient temperature: 0 to 40°C, no condensation)	
Connection of MA smooth remote controller / MA deluxe remote controller	Communication cable	2-wire (recommended: optional PAC remote controller cable PAC-YT81HC)
	Communication cable distance	Max. 10m
Indoor unit connecting cable	Dedicated 5-wire cable	
Weight	360 g (including indoor unit connecting cable)	

## Dimensions

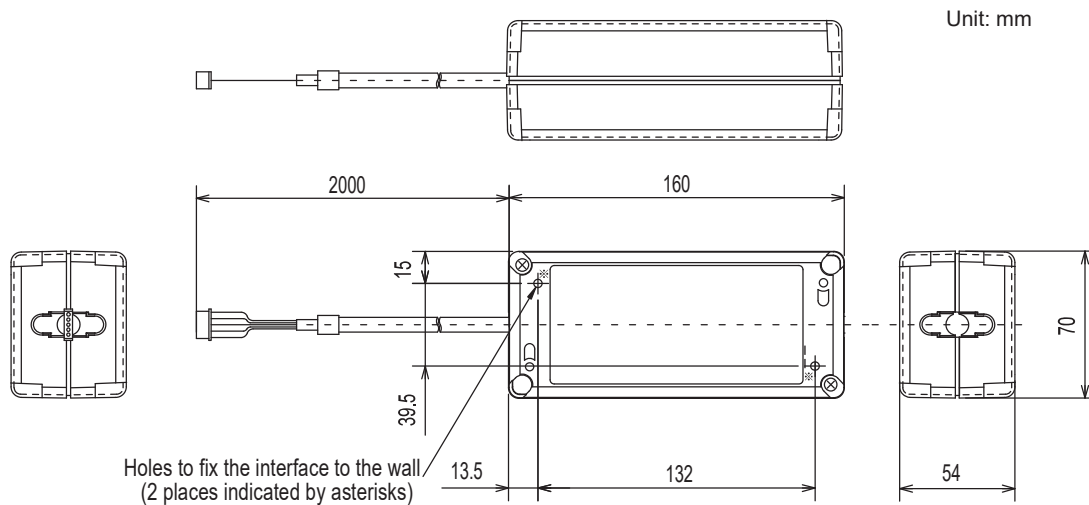

# How to Use / How to Install

## 1. Before Installation

### 1.1. How to Use the SYSTEM CONTROL Interface.

**■Functions**

**Connecting with M-NET system (Fig. 2-1)**

The room air conditioner can be managed centralized or individually by the system controller using M-NET communications control.

**Used as wired remote controller (Fig. 2-2)**

MA remote controller can be used as a wired remote controller.

**Remote control (Fig. 2-3)**

Contact signals enable inputting of ON/OFF, prohibiting/allowing operation, and heating/cooling.

**Status indicator output (Fig. 2-4)**

Signals of ON/OFF, error/normal, heater ON/OFF, and humidifier ON/OFF are output.

**■Sample System Configuration**

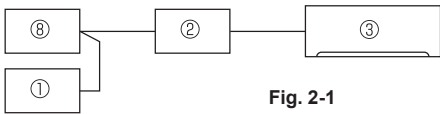

Fig. 2-1

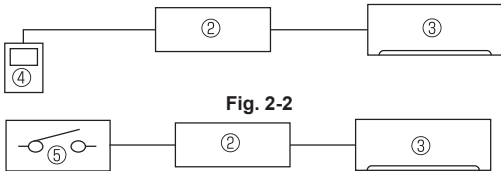

Fig. 2-2



Fig. 2-3

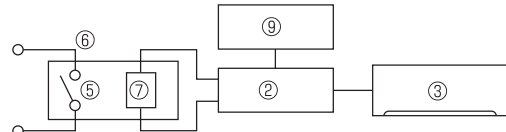
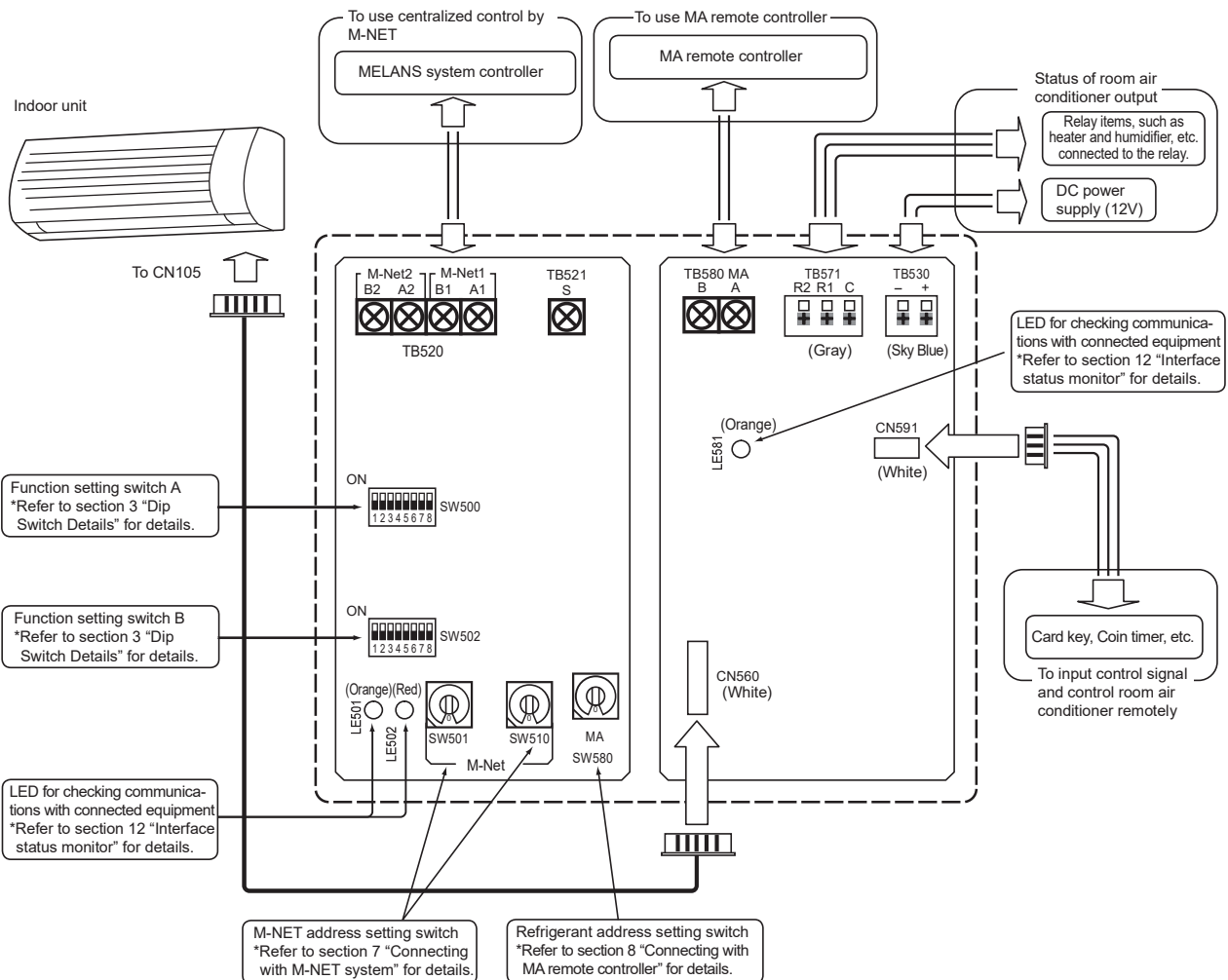

Fig. 2-4

- ① System controller, etc
- ② SYSTEM CONTROL Interface
- ③ Indoor Unit
- ④ MA remote controller
- ⑤ Contact point
- ⑥ Relay
- ⑦ Coil
- ⑧ Power supply unit for M-NET transmission line
- ⑨ External power supply for 12V DC

## 2. Function and electric wiring of interface each part



### 3. Dip Switch Details

Functions	SW No.	Functions	OFF (Factory setting)	ON	
Function setting Switch A	SW500-1	Output setting	Switching output of heater ON/OFF (single operation)		
	SW500-2	Turn on/off with power	Not available	Available	
	SW500-3	Room temperature detector	Indoor unit	MA remote controller	
	SW500-4 SW500-5	Output setting	Switching output of ON/OFF, error/normal, heater ON/OFF, and humidifier ON/OFF		
	SW500-6	Input setting	Input of ON/OFF and prohibiting/allowing operation	Input of ON/OFF and heating/cooling	
	SW500-7	Interface status display switching	LE501: Confirmation of communications with indoor unit LE502: Confirmation of communications with M-NET LE581: Confirmation of supplying power to MA remote controller	LE501: Confirmation of communications with MA remote controller LE502: Extinguished LE581: Confirmation of supplying power to MA remote controller	
	SW500-8	Not in use	— (Set to OFF)	—	
	Function setting Switch B	SW502-1	Output switching	12 VDC output during operation or error, etc	12 VDC output during stop or operating normally, etc
SW502-2		Input mode	Level contact	Pulse contact	
SW502-3		Setting of range of prohibited operations by contact point	M-NET system controller ON/OFF operation allowed	M-NET system controller ON/OFF operation prohibited	
SW502-4		Input switching	Input mode when level contact	Running or operating the machine is prohibited, etc by short circuiting the level contact	Running or operating machine is prohibited, etc by level contact opening
			Input mode when pulse contact	ON/OFF is inverted by pressing pulse contact	ON or OFF no matter how many times pulse contact is pressed
SW502-5		Behavior when operation by contact point is prohibited	State before prohibition of operation by contact point	Air conditioner running stop	
SW502-6		Behavior when prohibition of operation by contact point is canceled	State before canceling prohibition of operation by contact point	Running air conditioner	
SW502-7		Dual auto mode*	Available	Not available	
SW502-8	Setting when P series is mixed in the same group (only when running group operation using the MA remote controller)	No mixture	Mixed		

\* This function cannot be used regardless of the setting of SW502-7 when any of System controller, ME remote controller, or MA remote controller which are not compatible with Dual auto mode are connected to this interface unit.  
 This function cannot be used regardless of the setting of SW502-7 when the air conditioner which is not compatible with Dual auto mode is set in the same group.  
 When you connect MA remote controller to an indoor unit, Dual auto mode is not available. (Set SW502-7 ON.)  
 When you use this function, the operation mode cannot be set to automatic by the remote controller attached to the air conditioner.

### 4. Parts

Accessory											
①	Interface unit [with connecting cable (5-core)]		1	⑤	Mounting cord clamps (medium)		4	⑨	Fasteners (for joining the wires)		5
②	Screws for mounting 3.5×12		2	⑥	Mounting cord clamps (large)		3	⑩	Lead wires (3-core)		1
③	Cushioning material (with adhesive)		1	⑦	Screws for mounting 3.5 × 12 ④, ⑤ and ⑥ (Use when attaching the clamps to the interface unit)		4	⑪	Screws for mounting 4 × 10 ⑤ (Use when fixing near the room air conditioner)		1
④	Mounting cord clamps (small)		2	⑧	Cable ties		9	⑫	Screws for mounting 4 × 16 ⑤ (Use when joining room air conditioner parts)		1

Item to be Prepare at the Installation Site	
Ⓐ	M-NET communication cable 2-core shield cables CVVS/CPEVS, 1.25 mm <sup>2</sup> [AWG 16] or more.* • When cross-wired by same terminal box, 1.25 mm <sup>2</sup> [AWG 16] is used. CPEVS: PE insulated PVC jacketed shielded communication cable CVVS: PVC insulated PVC jacketed shielded control cable PE: Polyethylene PVC: Polyvinyl chloride
Ⓑ	Remote control cable (for connecting the ME Remote Controller) 2-core shield cables CVVS/CPEVS* • When the distance from the interface unit ① is less than 10 m: 0.3 mm <sup>2</sup> [33 ft.: AWG 22] or more.* • When the distance from the interface unit ① is not less than 10 m: 1.25 mm <sup>2</sup> [33 ft.: AWG 16] or more.*
Ⓒ	Remote control cable (for connecting the MA Remote Controller) 2-core sheath cable 0.3 mm <sup>2</sup> to 1.25 mm <sup>2</sup> * [AWG 22 to 16]*
Ⓓ	Signal cable (also used as extension cable) Sheath cable 0.3 mm <sup>2</sup> [AWG 22] or more.* • When remote control: The extension cable of Lead wires ⑩ • When status signal output: The cable for relay connection, or cable for DC power
Ⓔ	Related parts sold separately Prepare the necessary number of parts sold separately as needed for your system.

\* Please use cable with supplementary insulation.  
 Use wires which have insulation more than the MAX voltage.  
 MAX voltage is defined according to the law of the country where the interface is used.

## 5. Connecting the SYSTEM CONTROL Interface to a room air conditioner

- Connect the interface unit ❶ and the indoor control board of a room air conditioner using the connecting cable (5-core) that comes with the interface unit ❶.

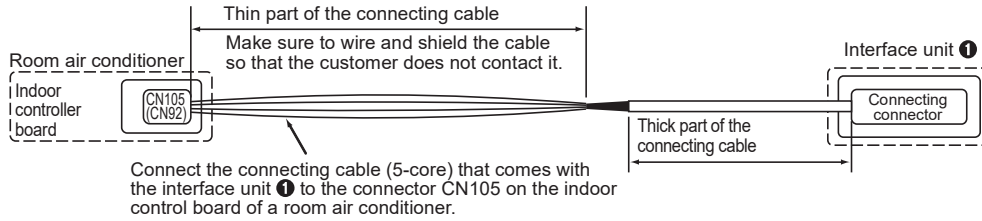

**Warning**

Securely fix the connecting cable in the designated place. Failure to do so may cause an electric shock, fire, or malfunction.

- The connecting cable (5-core) connected to a room air conditioner should be wired according to the room air conditioner installation manual.

**Notes**

- Extending or shortening the connecting cable (5-core) that comes out of the interface unit ❶ cause it to malfunction. Also, keep the connecting cable (5-core) as far as possible away from the electrical wires and ground wire. Do not bundle them together.
- To prevent the board from being damaged by static electricity, always remove static electricity before starting work.

## 6. Connecting the SYSTEM CONTROL Interface with each system

(For details on each system, see the relevant instruction manual.)

- Screw the mounting cord clamp ❷~❹ according to the thickness of the connecting cable used for each system. Fasten the cable tie ❸ as shown in the figure to prevent undesirable movement of the connecting cable.

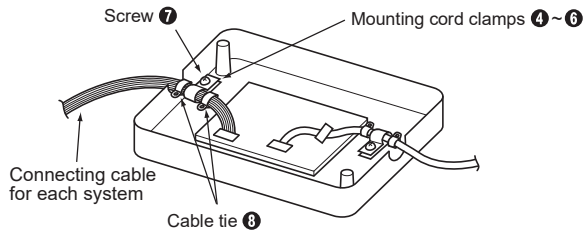

- The connecting cable (5-core) connected to a room air conditioner should be mounted at the room air conditioner or its vicinity.

If the screw for the cable mount of the room air conditioner cannot be used, replace with the screw for mounting ❻.

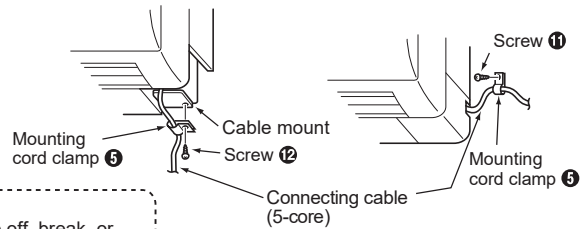

**Notes**

- If the connecting cable is not securely mounted, the connector may come off, break, or malfunction.
- The dip switch (SW500, SW502) and the rotary switch (SW501, SW510, SW580) on the interface unit ❶ do not operate if they are not set correctly.

- Conduct the settings of the interface unit ❶ dip switch (SW500, SW502) and rotary switch (SW501, SW510, SW580) before turning on the power.

## 7. Connecting with M-NET system

### ■ Connecting the SYSTEM CONTROL Interface to M-NET cable

The room air conditioner can be managed centralized or individually by the system controller using M-NET communications control.

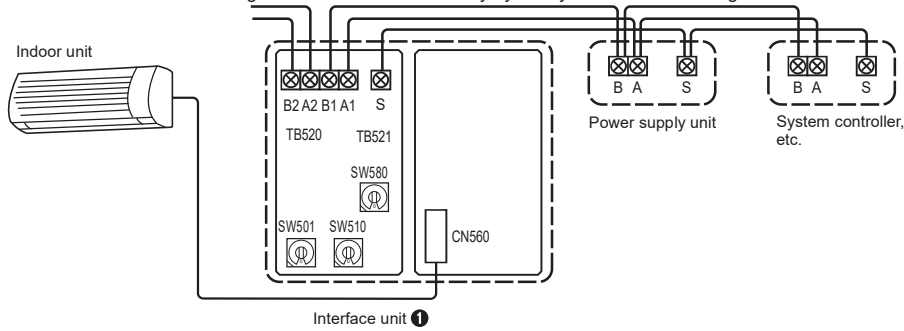

- To connect with the system controller and ME remote controller, connect the M-NET communication cable **A** or ME remote control cable **B** with TB520. (It is unpolarized.) Connect 2 core communication cable with A1/B1 or A2/B2. (There will be no problems with connecting to either one.)
- Cross the shield portion of each connecting cable using the S terminal only when cross wiring the communication cables **A**.
- After wiring is complete, mount securely with any of mounting cord clamp **4** to **6**, and fix with cable tie **8** as shown in the figure.

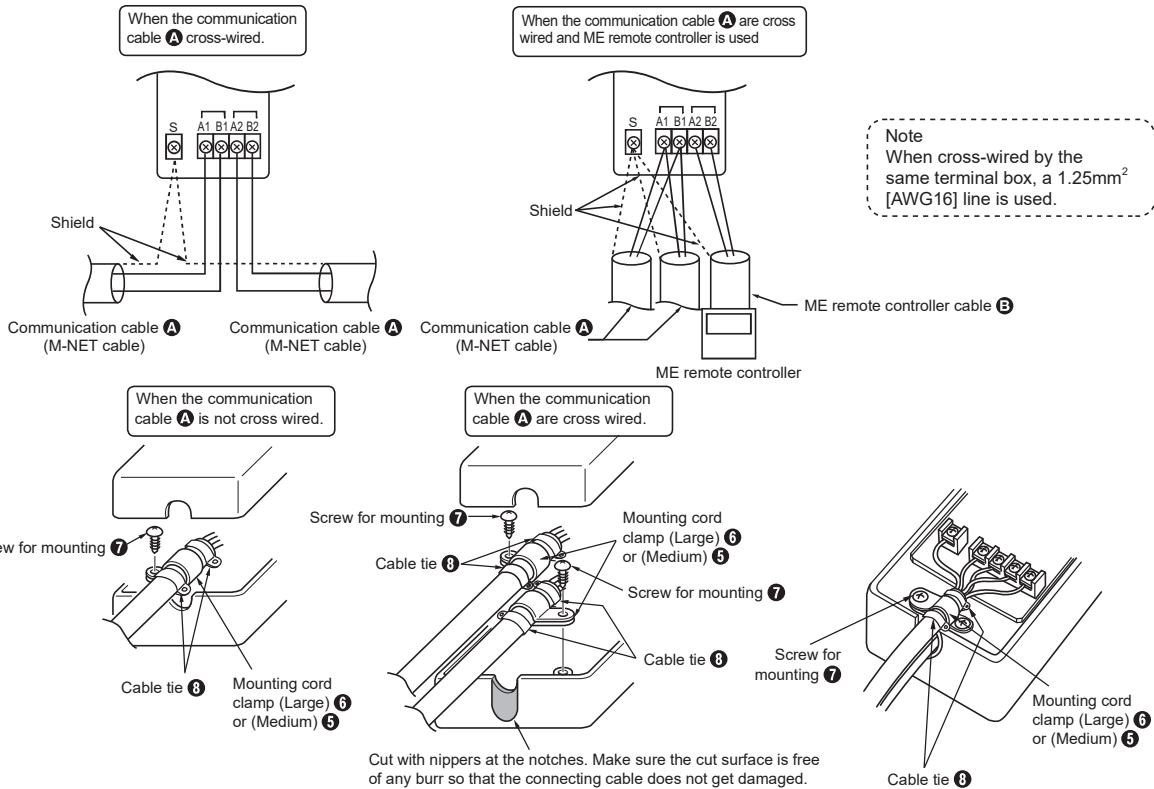

Note  
When cross-wired by the same terminal box, a 1.25mm<sup>2</sup> [AWG16] line is used.

- \* To prevent penetration by condensation, insects, etc., seal the opening well with putty.
- Notes
- Electrical work should be performed in accordance with the Technical Standards Regarding Electrical Equipment and the Interior Wiring Standards.
  - Connecting wires and remote control cables should be located as far away from other electrical wiring as possible. Placing them too closely together could cause a malfunction.
  - To connect with the M-NET system and MA remote controller, connection is limited to only one unit of the MA remote controller.
  - Do not put in the same group as City Multi or P series.
  - Test run cannot be conducted from the ME remote controller or the system controller.

### ■ Setting when M-NET is connected

SW No.	Address	Comments
SW510 SW501	M-NET address 10s position 1s position  SW510 SW501	SW510 sets the 10s position of the address and SW501 sets the 1s position of the address. (Address setting can be set from 01 ~ 50.) For example, to set a unit to the address 25, set SW510 to "2" and SW501 to "5." * The figure to the left is for address 1.
SW580	Refrigerant address  SW580	When the MA remote controller is not used, set the refrigerant address (SW580) to "1."

OPTIONAL PARTS

INDOOR UNIT

## 8. Connecting with MA remote controller

### ■ Connecting the SYSTEM CONTROL Interface to MA remote controller

A room air conditioner can be operated with the wired remote control.

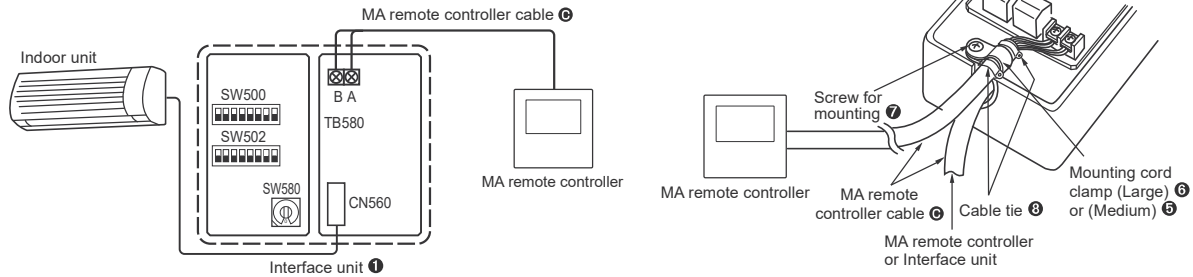

- To connect with the MA remote controller, connect the MA remote control cable ② with TB580. (It is unpolarized.)
- When more than one unit of room air conditioner is operated in a group, make a cross wire connection at TB580 with the MA remote control cable ②.
- The MA remote controller can carry out simultaneous control of up to 16 sets of room air conditioners.
- Up to two MA remote controllers can be connected in one group.  
However, up to one can be connected when using PAR-CT0\*MA.
- Wiring length from the interface at the refrigerant address "0" to the MA remote controller should be less than 10 m [33 ft.].
- To operate the room air conditioner in a group, make the total length of wiring for the MA remote controller less than 50 m [164 ft.].

#### Notes

- Be sure to set the "Auto Heating/Cooling Display Setting" of the MA remote controller OFF before use.  
\* For details on the "Auto Heating/Cooling Display Setting", refer to the MA remote controller instruction manual.
- \* When the "Auto Heating/Cooling Display Setting" is ON, the remote controller display may differ from the actual operating status of the unit.
- A test run cannot be initiated using the test run switch on the MA remote controller.
- Group control with CITY MULTI is unable.
- When you use the PAR-CT0\*MA with M-NET system, follow the restrictions below.
  1. Be sure to set "Brightness setting" of PAR-CT0\*MA to "Low".
  2. The wiring length from the interface at the refrigerant address "0" to the PAR-CT0\*MA should be less than 7 m [23 ft.].
  3. Some room air conditioners cannot be used.  
Make sure the room air conditioner can be used before installing it.
  4. Do not use the external output (CN104) of the indoor unit.  
\* If the indoor unit does not have the external output (CN104), you cannot use the PAR-CT0\*MA with M-NET system.
- When you use the PAR-4\*MA with M-NET system, follow either one of the restrictions below.
  - Be sure to set "Brightness setting" of PAR-4\*MA to "Low".
  - Do not use "Setting Signal Output" of this interface unit.

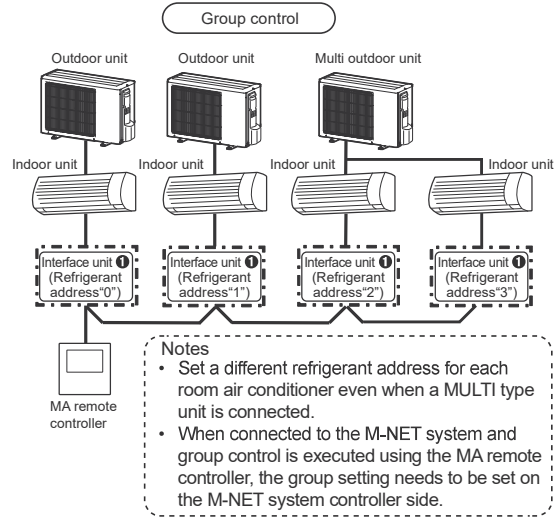

#### Notes

- Set a different refrigerant address for each room air conditioner even when a MULTI type unit is connected.
- When connected to the M-NET system and group control is executed using the MA remote controller, the group setting needs to be set on the M-NET system controller side.

### ■ Setting when MA remote controller is connected

#### ● Setup of a refrigerant address

SW No.	Refrigerant address	Comments
SW580	Address can be set from 0 to 15 	<ul style="list-style-type: none"> <li>• Set the refrigerant address of the unit that supplies electric power to the MA remote controller to "0."</li> <li>• When carrying out group operation of two or more room air conditioners, set different refrigerant addresses within the group. * A to F of the rotary switch correspond to refrigerant addresses 10 to 15.</li> </ul>

#### ● Setup of Room temperature detector position

Functions	SW No.	Operating details
Room temperature detector position 	SW500 ON OFF	SW500-3: OFF • Temperature detected by suction temperature sensor of the unit is made to be room temperature. SW500-3: ON • Temperature detected by temperature sensor of the remote controller is made to be room temperature.

#### ● Setting when P series is mixed in the same group (only when running group operation using the MA remote controller)

Functions	SW No.	Operating details
P series is mixed in the same group 	SW502 ON OFF	SW502-8: OFF • Set to OFF when P series is not mixed in the same group. SW502-8: ON • Set to ON when P series is mixed in the same group.



## 9. Remote Control

### ■ Connecting the SYSTEM CONTROL Interface

You can turn room air conditioner on/off, prohibit/allow manual operations, or input of heating/cooling with the ON/OFF switch.

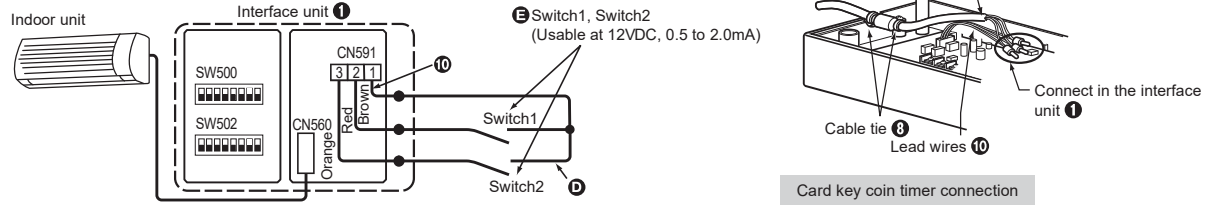

- Connect CN591 with Switch1 and Switch2 as shown in figure above.
  - Connect the supplied lead wires (3-core) ⑩ to the connector CN591 on the interface unit.
  - Connect the supplied lead wires (3-core) ⑩ to the connecting cable ① in the interface ① as shown in the figure on the right side.
  - Wiring length from the interface to the Switch1 and Switch2 should be less than 50m [164ft].
  - Procure and wire locally the remote control part including the switches.
  - For each connection pattern, refer to "Setting when using remote control."
- \*When using a Card key/Coin timer, make connections shown in the figure to the right.

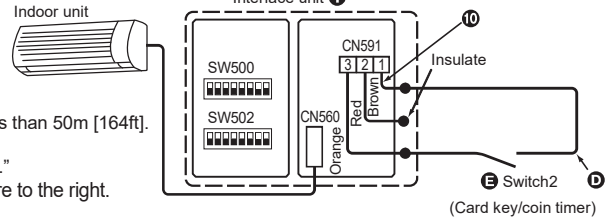

### ■ Setting when using remote control (Select one between No.1 through 5 and set.)

\*Set No.1, No.6, and No.7 when using the card key/coin timer.

No.	Functions	SW No.	How to use	Operating details
1	ON/OFF Manual operation prohibited/allowed (Level Contact)	SW500 SW502		<ul style="list-style-type: none"> <li>• Unit is turned on when Switch1 has a short-circuit, and off when open. (Regardless of the Switch1 operation condition, the latest operation is prioritized.)</li> <li>• When Switch2 has a short-circuit, manual operation is prohibited,* and when open, manual operation is allowed.</li> <li>• When SW502-4 is turned on, the opening and short-circuiting of Switch1 and Switch2 result in their operating in the opposite manner. *When manual operation is prohibited, ON/OFF operation of the wireless remote controller, the MA remote controller, and the ME remote controller is prohibited. (Operation from Switch1 and M-NET system controller is possible.)</li> </ul>
2	ON/OFF Manual operation prohibited/allowed (Pulse Contact)	SW500 SW502		<ul style="list-style-type: none"> <li>• Every time Switch1 is pressed, ON/OFF is switched over. (Regardless of the Switch1 operation condition, the latest operation is prioritized.)</li> <li>• Every time Switch2 is pressed, the manual operation prohibited*/the manual operation allowed is switched over. *When the manual operation is prohibited, ON/OFF operation of the wireless remote controller, the MA remote controller, and the ME remote controller is prohibited. (Operation from Switch1 and M-NET system controller is possible.)</li> </ul>
3	ON/OFF Remote operation/Manual operation (Level Contact)	SW500 SW502		<ul style="list-style-type: none"> <li>• Unit is turned on when Switch1 has a short-circuit, and off when open.</li> <li>• When Switch2 has a short-circuit, only Switch1 is enabled (remote operation)*, when open, only Switch1 is disabled (manual operation).</li> <li>• When SW502-4 is turned on, the opening and short-circuiting of Switch1 and Switch2 result in their operating in the opposite manner. *In remote operation, ON/OFF operation from the wireless remote controller, the MA remote controller, the ME remote controller, and the M-NET system controller cannot be used.</li> </ul>
4	ON, OFF (Pulse Contact)	SW500 SW502		<ul style="list-style-type: none"> <li>• Unit is turned on no matter how many times Switch1 is pressed.</li> <li>• Unit is turned off no matter how many times Switch2 is pressed. And regardless of the Switch1, Switch2 operation condition, the latest operation is prioritized.</li> <li>• ON/OFF operation from the wireless remote controller, the ME remote controller, the MA remote controller, and the M-NET system controller is enabled.</li> </ul>
5	Heating/cooling input (Level Contact)	SW500 SW502		<ul style="list-style-type: none"> <li>• Unit is turned on when Switch1 has a short circuit, and off when open.</li> <li>• Heating runs when Switch2 has a short circuit, and cooling runs when open.</li> <li>• When SW502-4 is turned on, the opening and short-circuiting of Switch1 and Switch2 result in their operating in the opposite manner. * As for ON/OFF operation and heating/cooling operation from the wireless remote controller, MA remote controller, ME remote controller, system controller, Switch1, and Switch2, the latest operation is prioritized.</li> </ul>

### ■ Setting operation (Valid only for No.1 and No.2. The following 2 functions can be used at the same time.)

No.	Functions	SW No.	How to use	Operating details
6	Behavior when operation is prohibited.	SW502	Operational status of room air conditioner when manual operation is prohibited can be set.	SW502-5: OFF • When manual operation is prohibited by Switch2, operational status is maintained as that before manual operation is prohibited. SW502-5: ON • When manual operation is prohibited by Switch2, the room air conditioner turns off.
7	Behavior when prohibition of operation is canceled.	SW502	Operational status of room air conditioner when prohibition of manual operation is canceled can be set.	SW502-6: OFF • When prohibition of manual operation is canceled by Switch2, operational status is maintained as that before cancellation. SW502-6: ON • When prohibition of manual operation is canceled by Switch2, the room air conditioner turns on.

OPTIONAL PARTS

INDOOR UNIT

## 10. Setting Signal Output

### ■ Connecting the SYSTEM CONTROL Interface

Each relay can be turned ON/OFF by synchronizing with the room air conditioner's ON/OFF, error/normal, Heater ON/Heater OFF, and Humidifier ON/Humidifier OFF.

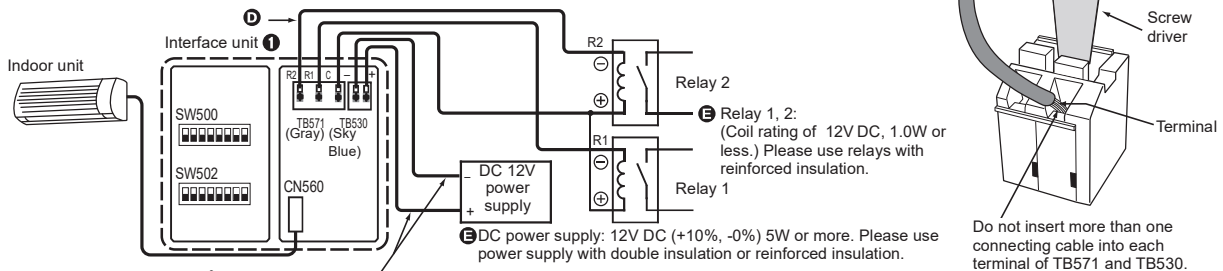

Please use the cable of 0.5mm<sup>2</sup> [AWG20] or more.  
The cable must fit into TB530 and meet DC12V power supply.

#### Notes

- Connecting terminal TB530 for power supply is polarized, so confirm proper polarity of the terminals before connecting.
- Do not connect 12V DC from the DC power supply to TB571.
- Confirm polarity when using a diode built-in relay. C of TB571 is electropositive potential ⊕, and R1 and R2 are negative potential ⊖.
- For TB571 and TB530, insert wiring after inserting the flathead screwdriver into the terminal.
- Appropriate electric wire for TB571 and TB530 is as follows. Stranded wire: 0.3mm<sup>2</sup> to 1.25mm<sup>2</sup> [AWG22 to 16] Solid wire: ø0.4mm to ø1.2mm [ø1/64in. to ø3/64in.]
- Peeling dimension of the electric wire for TB571 and TB530 is 7mm to 10mm [9/32in. to 25/64in.].
- Wiring length from the interface to Relay 1 and Relay 2 should be less than 50m [164ft].

### ■ Setting when using Status Signal Output

Functions	SW No.	Operating details
ON/OFF, Error/Normal Output	<p>SW500</p> <p>SW502</p> <p>OFF</p>	<p>SW502-1: OFF</p> <ul style="list-style-type: none"> <li>Relay 1 is on when room air conditioner is on, and off when room air conditioner is off.</li> <li>Relay 2 is on when room air conditioner is in error, and off when room air conditioner is operating normally.</li> </ul> <p>SW502-1: ON</p> <ul style="list-style-type: none"> <li>Relay 1 and 2 behavior are opposite of those above.</li> </ul>
ON/OFF, Heater Control Output	<p>SW500</p> <p>SW502</p> <p>OFF</p>	<p>SW502-1: OFF</p> <ul style="list-style-type: none"> <li>Relay 1 is on when room air conditioner is on, and off when room air conditioner is off.</li> <li>When the air conditioner runs in the heating (automatic heating) mode and room temperature becomes the set temperature - 2.5 °C (4.5 °F) or lower, the Relay 2 (heater) turns on.</li> <li>When the air conditioner runs in a mode other than the heating (automatic heating) or it is OFF, or when room temperature becomes the set temperature or higher, the Relay 2 (heater) turns off.</li> </ul> <p>SW502-1: ON</p> <ul style="list-style-type: none"> <li>Relay 1 and 2 behavior are opposite of those above.</li> </ul>
ON/OFF, Humidifier Control Output	<p>SW500</p> <p>SW502</p> <p>OFF</p>	<p>SW502-1: OFF</p> <ul style="list-style-type: none"> <li>Relay 1 is on when room air conditioner is on, and off when room air conditioner is off.</li> <li>When the air conditioner runs in the heating (automatic heating) mode, Relay 2 (humidifier) turns on. When the air conditioner runs in a mode other than heating (automatic heating) or it is OFF, Relay 2 (humidifier) turns off.</li> </ul> <p>SW502-1: ON</p> <ul style="list-style-type: none"> <li>Relay 1 and 2 behavior are opposite of those above.</li> </ul>
Heater Control, Humidifier Control Output*	<p>SW500</p> <p>SW502</p> <p>OFF</p>	<p>SW502-1: OFF</p> <ul style="list-style-type: none"> <li>When the air conditioner runs in the heating (automatic heating) mode and room temperature becomes the set temperature - 2.5 °C (4.5 °F) or lower, Relay 1 (heater) turns on.</li> <li>When the air conditioner runs in a mode other than the heating (automatic heating) or it is OFF, or when room temperature becomes the set temperature or higher, Relay 1 (heater) turns off.</li> <li>When the air conditioner runs in the heating (automatic heating) mode, Relay 2 (humidifier) turns on. When the air conditioner runs in a mode other than heating (automatic heating) or OFF, Relay 2 (humidifier) turns off.</li> </ul> <p>SW502-1: ON</p> <ul style="list-style-type: none"> <li>Relay 1 and 2 behavior are opposite of those above.</li> </ul>
ON/OFF, Humidifier Control (single operation) Output	<p>SW500</p> <p>SW502</p>	<p>Relay 1 is on when ON is set by System controller, ME remote controller or MA remote controller, and off when OFF is set by these controllers.</p> <p>When room temperature becomes the set temperature or lower in the heating (automatic heating) mode, the Relay 2 (heater) turns on. When a mode other than heating (automatic heating) or OFF is set by System controller, ME remote controller or MA remote controller, or when room temperature becomes higher than the set temperature + 1 °C (2 °F), the Relay 2 (heater) turns off.</p> <p>* This function is to run the heater instead of the air conditioner in the heating mode. The air conditioner stops in the heating mode.</p> <p>Do not use the remote controller attached to the air conditioner. If you use it, the operation may not reflect the setting.</p> <p>The position of detecting the room temperature is where MA remote controller is put, so make sure to connect it to the interface unit.</p>



## 11. Turn on/off with power

The room air conditioner turns on when power is supplied.

- When using for the first time, set to the operational status of your choice with the remote controller and leave the power off for 1 minute.
- \* When not used for a long period of time, you should set to the operational status of your choice again with the remote controller.

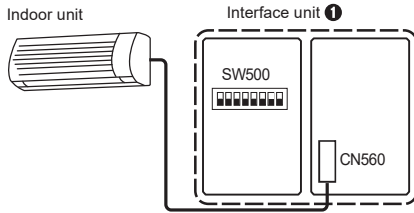

### Notes

- The turn on/off with power function cannot be used when connected to multiple outdoor units.
- When starting two or more room air conditioners by using the turn on/off with power function, make the system so they do not recover simultaneously. (To avoid inrush current, start sequentially.)

Setting when using Turn on/off with power

Functions	SW No.	Operating details
Turn on/off with power	<p>SW500</p> <p>ON</p> <p>OFF</p>	<p>SW500-2: OFF</p> <ul style="list-style-type: none"> <li>• After the power is supplied, the room air conditioner resumes working in the previous running condition. When AUTO RESTART FUNCTION is not set to the room air conditioner, it remains off.</li> </ul> <p>SW500-2: ON</p> <ul style="list-style-type: none"> <li>• The room air conditioner turns on when power is supplied.</li> </ul>

## 12. Interface status monitor

You can check the status of the interface unit by the LED lamp on the interface unit 1 board.

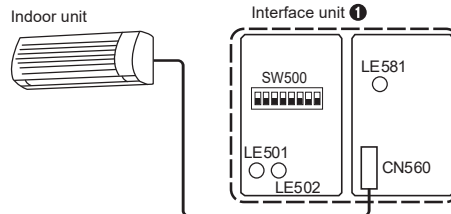

- Use the table below to check communications. If communications cannot be carried out normally, check that the relevant communications line is not disconnected from the connector or terminal box.

Functions	SW No.	Operating details
Interface status monitor	<p>SW500</p> <p>ON</p> <p>OFF</p>	<p>SW500-7: OFF</p> <ul style="list-style-type: none"> <li>• LE501 (Orange): When blinking at an interval of about 1 second, the Interface unit is communicating normally with the room air conditioner. When the lamp is off, the Interface unit is not communicating normally with the room air conditioner.</li> <li>• LE502 (Red): When blinking at an interval of about 1 minute, the Interface unit is communicating normally with the M-NET controller. When the lamp is off, the Interface unit is not communicating normally with the M-NET controller.</li> </ul> <p>SW500-7: ON</p> <ul style="list-style-type: none"> <li>• LE501 (Orange): When blinking at an interval of about 10 second, the Interface unit is communicating normally with the MA remote controller. When the lamp is off, the Interface unit is not communicating normally with the MA remote controller.</li> <li>• LE502 (Red): Extinguished</li> </ul> <p>* LE581 (Orange) displays the following status irrespective whether SW500-7 is on or off.</p> <ul style="list-style-type: none"> <li>• When lit, power is supplied to the MA remote controller from the Interface unit 1. When extinguished, power is not supplied.</li> </ul>

### 13. Mounting the SYSTEM CONTROL Interface Unit

**Notes**

- The Interface unit ❶ should be placed in a location where the connecting cable (5-core) from the interface unit ❶ can reach an indoor unit.
- The device will not function properly the connecting cable is extended, so the connecting cable (5-core) should no be extended.
- Mount the interface unit ❶ securely to a pillar or wall using 2 or more screws ❷.

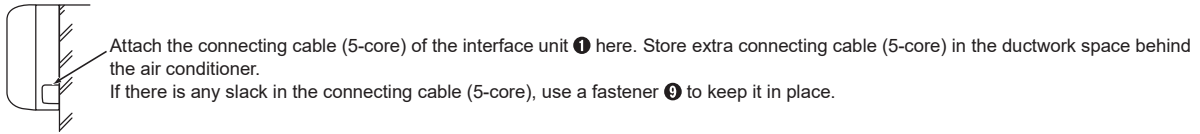

■ When Mounting Directly to a Wall

Mount the interface unit ❶ case to the wall using the mounting screws ❷.

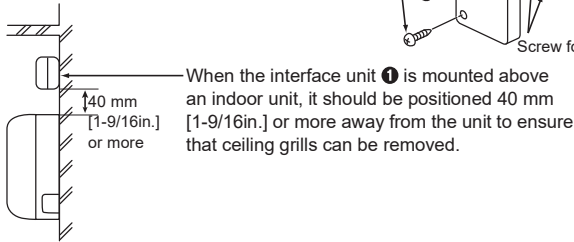
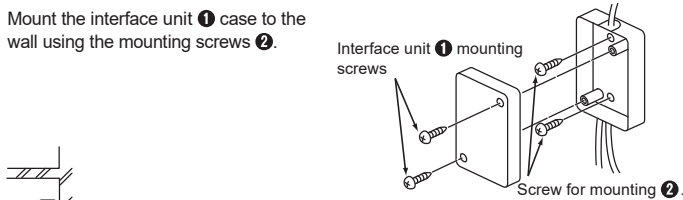

■ When mounting the interface unit inside a ceiling

When mounting the interface unit ❶ inside a ceiling or wall, install an access door to facilitate maintenance.

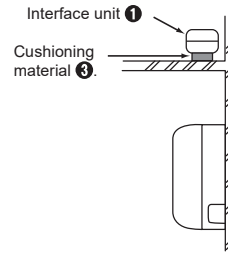

\* When mounting the interface unit ❶ using a cushioning material ❸, be sure to mount it in a location where it will not fall.

### 14. Notes Regarding Use

The following control information should be thoroughly explained and provided to the users of this device. (Please provide these instructions to the user once the installation is complete.)

This Interface unit ❶ operates room air conditioners using the controls of a City-Multi or P series, but there are several limitations imposed as a result of the functional differences between room air conditioners and packaged air conditioners.

1. When operating the system using a System Controller, MA Remote Controller, or ME Remote Controller these operations will not appear on the display of the wireless remote controller.
2. When original dehumidification mode is set with the remote controller attached to the room air conditioner, "Dry" is displayed because there is no mode corresponding to dehumidification on the MA remote controller, ME remote controller, and the system controller.
3. Because the temperature range of the room air conditioners is broader than a System Controller, MA Remote Controller, or ME Remote Controller, when the room air conditioners is set to lower than 17°C (63°F) or higher than 30°C (87°F), the temperature display on the a System Controller, MA Remote Controller, or ME Remote Controller will show the minimum or maximum temperature that can be set. (For example, even if the room air conditioner is set to cool a room to 16°C (61°F), the display on a System Controller, MA Remote controller, or ME Remote Controller may read "17°C" (63°F)).
4. Timer operations should be set using only the remote controller that came with the room air conditioners or the a System Controller, MA Remote Controller, or ME Remote Controller. If both are used to set the timer to the same time, the timer will not function properly.
5. When "Manual operation prohibited" (ON/OFF, setting temperature, operation mode) is set with the system controller, the corresponding operation by the remote controller attached to the room air conditioner is not accepted, but allowed operation is reflected. A beep sounds during operation to confirm reception.
6. A part of functions including the operation of horizontal air blow direction cannot be used from the ME remote controller, the system controller, and the MA remote controller.
7. "Manual operation prohibited" (filter sign, air direction, fan speed, timer) cannot be set by system controller.

### 15. Specifications

Indoor unit side	Input voltage	12V $\overline{\text{---}}$
	Power consumption	1.8W
	Input current	0.15A
Power supply unit side	Input voltage	12V $\overline{\text{---}}$
	Power consumption	4.8W
	Input current	0.4A

OPTIONAL PARTS

INDOOR UNIT