

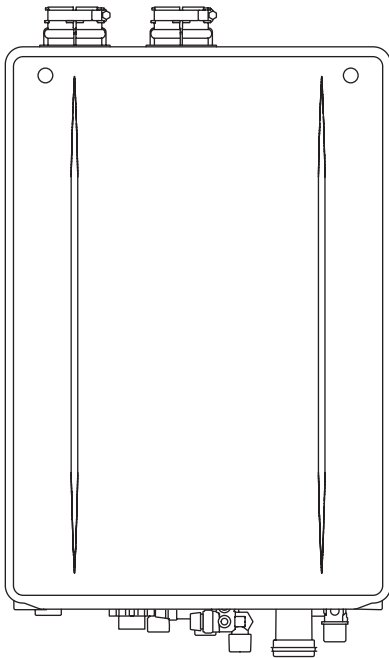

Owner's Guide

CONDENSING TANKLESS GAS Water Heater

Models : **NRCR111DV (GQ-C3260WXQ-FF US)**
NRCR92DV (GQ-C2660WXQ-FF US)



Thank you for purchasing this Noritz Tankless Gas Water Heater. Before using:

- Read this manual completely for operation instructions.
- Completely fill out the warranty registration card (included separately) and mail the detachable portion to Noritz America Corporation.
- Keep this manual (and the remainder of the warranty registration card) where it can be found whenever necessary.

Installation must conform with local codes, or in the absence of local codes, the National Fuel Gas Code, ANSI Z223.1 / NFPA 54 - latest edition and/or the Natural Gas and Propane Installation Code CSA B149.1- latest edition.

When applicable, installation must conform with the Manufactured Home Construction and Safety Standard, Title 24 CFR, Part 3280 or the Canadian Standard CAN/CSA-Z240 MH Mobile Homes, Series M86.

Noritz America reserves the right to discontinue, or change at any time, the designs and/or specifications of its products without notice.

FOR USE IN RESIDENTIAL OR
MANUFACTURED HOME APPLICATIONS.

⚠ WARNING

If the information in this manual is not followed exactly, a fire or explosion may result causing property damage, personal injury or death.

- **Do not store or use gasoline or other flammable vapors and liquids in the vicinity of this or any other appliance.**
- **WHAT TO DO IF YOU SMELL GAS**
 - Do not try to light any appliance.
 - Do not touch any electrical switch; do not use any phone in your building.
 - Immediately call your gas supplier from a neighbor's phone. Follow the gas supplier's instructions.
 - If you cannot reach your gas supplier, call the fire department.
- **Installation and service must be performed by a qualified installer, service agency or the gas supplier.**



Low NOx Approved by SCAQMD
14 ng/J or 20 ppm
(Natural Gas Only)

NORITZ America Corporation

SBB8167
Rev. 05/19



Important Safety Information

To prevent damage to property and injury to the user, the icons shown below will be used to warn of varying levels of danger.

Every indication is critical to the safe operation of the Water Heater and must be understood and observed. Potential dangers from accidents during installation and use are divided into the following four categories. Closely observe these warnings; they are critical to your safety.

Icons warning of risk level

! This is the safety alert symbol. It is used to alert you to potential personal injury hazards. Obey all safety messages that follow this symbol to avoid possible injury or death.

⚠ DANGER Indicates an imminently hazardous situation which, if not avoided, will result in death or serious injury.

⚠ WARNING Indicates a potentially hazardous situation which, if not avoided, could result in death or serious injury.

⚠ CAUTION Indicates a potentially hazardous situation which, if not avoided, may result in minor or moderate injury.

NOTICE Indicates a potentially hazardous situation which, if not avoided, may result in property damage.

⚠ DANGER

Vapors from flammable liquids will explode and catch fire causing death or severe burns.

Do not use or store flammable products such as gasoline, solvents or adhesives in the same room or area near the Water Heater.



Keep flammable products:

1. Far away from the Water Heater.
2. In approved containers.
3. Tightly closed.
4. Out of children's reach.

Vapors:

1. Cannot be seen.
2. Vapors are heavier than air.
3. Go a long way on the floor.
4. Can be carried from other rooms to the main burner by air currents.

After the Water Heater has been out of use for a long time make sure that you fill the condensate trap with water.

This is to prevent dangerous exhaust gases from entering the building.

Failure to fill the condensate trap could result in severe personal injury or death.

(Refer to page 16 for further instructions.)

Hot Water Heater temperatures over 125°F (52°C) can cause severe burns instantly or death from scalding.

Children, disabled and elderly are at the highest risk of being scalded.

Feel water temperature before bathing or showering. Temperature limiting valves are available, consult with installer.

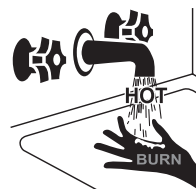

Do not use the Water Heater if the intake/exhaust pipe is displaced, has holes, is clogged or is corroded.

This will cause carbon monoxide poisoning and a potential fire hazard.

Do not allow anyone to change the water temperature while hot water is being used.

To prevent scalding, do not change the water temperature to a higher setting.

[When supplying combustion air from the indoors]

Check whether or not the air supply vent is blocked with dust, trash, a towel, or the like.

Blocking the opening may result in incomplete combustion.

⚠ WARNING

- A. This Water Heater does not have a pilot. It is equipped with an ignition device that automatically lights the burner. Do not try to light the burner by hand.
- B. BEFORE OPERATING smell all around the Water Heater area for evidence of leaking gas. Be sure to smell next to the floor because some gas is heavier than air and will settle on the floor.
- WHAT TO DO IF YOU SMELL GAS**
- Do not try to light any appliance.
 - Do not touch any electrical switch; do not use any phone in your building.
 - Immediately call your gas supplier from a neighbor's phone. Follow the gas supplier's instructions.
 - If you cannot reach your gas supplier, call the fire department.
- C. Use only your hand to turn the gas valve knob. Never use tools. If the knob will not turn by hand, don't try to repair it. Call a qualified service technician. Force or attempted repair may result in a fire or explosion.
- D. Do not use this Water Heater if any part has been under water. Immediately call a qualified service technician to inspect the Water Heater and to replace any damaged parts.

When a gas leak is noticed:

1. Stop use immediately.
2. Close the gas valve.

[Indoor Installation]

3. Open windows and doors.

If you detect abnormal combustion or abnormal odors, or during an earthquake, tornado or fire:

1. Turn off the hot water supply.
2. Turn off the power to the Water Heater.
3. Turn off gas and water supply valves.
4. Call the nearest Noritz agent.

Explosion Hazard;

If the temperature and pressure relief valve is dripping or leaking, have a qualified service technician replace it. Do not plug or remove the valve.

Failure to follow these instructions can result in fire or explosion, and personal injury or death.

Check the temperature of the running hot water before entering the shower.

Check the temperature before stepping into the bathtub.

To prevent burns or scalding, turn off the  button and wait until the appliance cools before performing maintenance.

Do not place the exhaust vent terminal in an indoor environment by means of adding walls and ceiling (Do not enclose using corrugated sheets, etc.).

Carbon monoxide poisoning or fire may occur as a result.

Leave the proper clearance between the Water Heater and nearby objects (trees, timber, boxes with flammable materials, etc.).

[Indoor Installation]

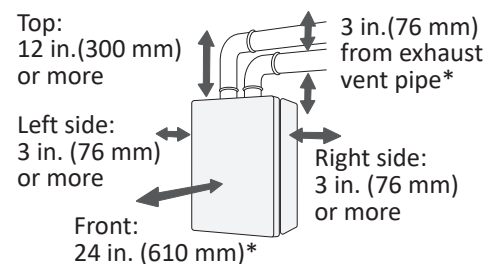

[Outdoor Installation]

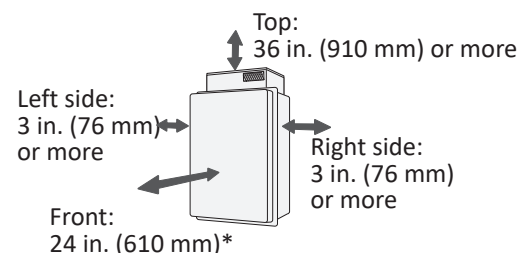

*Indicates suggested clearances for maintenance.

Do not place combustibles such as laundry, newspapers, oils etc. near the heater or the exhaust vent terminal.

Do not install this Water Heater in a recreational vehicle or on a boat as this may be a Carbon Monoxide Poisoning Hazard. Do not install this Water Heater in a mobile home when using SV conversion kit ("SV" configuration).

Do not use combustible chemicals such as oil, gasoline, benzene etc. in the near the heater or the exhaust vent terminal.

Do not store or use gasoline or other flammable vapors and liquids in the vicinity of this or any other appliance.

Do not place or use a spray can near the Water Heater or the exhaust vent terminal.

⚠ WARNING

Be sure the gas/power supplied matches “Type of Gas” and “Electrical Rating” on the rating plate.

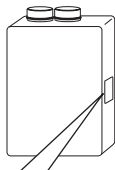

(e.g. NRRC111DV (GQ-C3260WXQ-FF US))

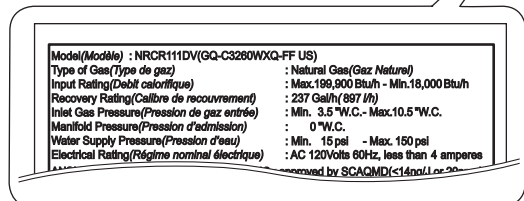

Installation and service must be performed by a qualified installer, service agency or the gas supplier.

Consult the nearest Noritz agent if the Water Heater location needs to be changed.

If this appliance will be installed in a location where hair spray or aerosols will be used, locate the appliance in a separate area that is supplied with fresh air from outdoors.

Do not use hair spray or spray detergent in the vicinity of the appliance.

Avoid installation in places where dust or debris will accumulate.
Dust may accumulate and reduce the performance of the unit's fan.
This can result in incomplete combustion.

[When supplying combustion air from the indoors]
Check the air supply opening for dust or obstructions.

To prevent injury or death, do not allow small children to bathe or play in the bathroom unsupervised.

Do not touch the power cord with wet hands.



Contact a qualified service technician for any necessary repairs, service or maintenance.

Do not use parts other than those specified for this appliance.

California Proposition 65 lists chemical substances known to the state to cause cancer, birth defects, death, serious illness or other reproductive harm. This product may contain such substances, be their origin from fuel combustion (gas, oil) or components of the product itself.

The gas conversion kit shall be installed by a qualified service agency in accordance with the manufacturer's instructions and all applicable codes and requirements of the authority having jurisdiction. The information in the instructions must be followed to minimize the risk of fire or explosion or to prevent property damage, personal injury, or death. The qualified service agency is responsible for the proper installation of this kit. The installation is not proper and complete until the operation of the converted appliance is checked as specified in the manufacturer's instructions supplied with the kit.

⚠ CAUTION

Be sure to electrically ground the appliance.

Keep power cord free of dust.

Do not use the Water Heater for other than hot water supply, shower and bath.

Do not use a broken or modified power cord.
Do not bind, bend or stretch power cords.
Do not scratch, modify, or subject them to impact or force.

Do not use condensate, discharged from the condensate drain pipe, for drinking or for consumption by animals.

If the appliance is installed in a location with very high humidity, condensate may form inside the unit and/or cause incomplete combustion, damage to the electrical components, or electric leakage.

Do not turn off the Water Heater while someone is bathing.

Do not cover the Water Heater and the exhaust vent terminal, store trash or debris near it, or in any way block the flow of fresh air to the appliance.

Do not touch the exhaust vent pipe and exhaust vent terminal during or immediately after operation of the Water Heater.

NOTICE

Do not drink water that has been inside the appliance for an extended period of time. Do not drink the first use of hot water from the appliance in the morning.

Clean the filter on the water inlet as frequently as required by the quality of your local water.

Keep the area around the appliance clean. If boxes, weeds, cobwebs, cockroaches etc. are in the vicinity of the appliance, damage or fire can result.

Do not install the appliance where the exhaust will blow on walls or windows.

If the water supply is in excess of 12 gpg (200 mg/L) of hardness, acidic or otherwise impure, treat the water with approved methods in order to ensure full warranty coverage. (See page 18)

Problems resulting from scale formation are not covered by the warranty.

Check ignition during use and extinction after use.

Do not run water through the appliance when appliance is not on.

When discharging hot water, make sure the appliance is ON. If water is run through the appliance with the appliance OFF, water may condense inside the appliance and cause incomplete combustion or damage to the internal electrical components. For single-handle fixtures, you'd turn the handle to the left.

This appliance is only approved for installation up to 4,500 ft (1,350 m) above sea level.

For installations at higher elevations, contact Noritz America for Instructions.

Do not disassemble the Remote Controller.

Do not use chlorine-based, acidic, alkaline detergents, organic solvents such as benzene and thinner, or Melamin Sponge to clean the Remote Controller.

This may cause discoloration, deformation, scratches or cracks.

Do not splash water on the Remote Controller. Do not expose the Remote Controller to steam.

Although it is water resistant, too much water can cause damage.

Do not locate the Remote Controller near stoves or ovens.

This may cause damage or failure.

Contact Noritz before using with a solar pre-heater.

Preventing damage from freezing (See page 14)

- Damage can occur from frozen water within the appliance and pipes even in warm environments. Be sure to read below for appropriate measures.
- Repairs for damage caused by freezing are not covered by the warranty.

Take necessary measures to prevent freezing of water and leakage of gas when leaving the appliance unused for long periods of time. (See page 15)

If it is snowing, check the exhaust vent terminal for blockage.

Contents

Important Safety Information	3
Contents	6
General Parts	7
Water Heater	7
Remote Controller	8
Features of the Auto-Recirculation Mode	9
Initial Operation	9
Using the Water Heater	10
Setting Hot Water Temperature	11
Customizable Settings	12
Limiting the Maximum Output Temperature	12
Muting the Remote Controller	12
Flow Meter Alarm	12
Stopping Recirculation Operation	13
Preventing Damage from Freezing	14
Regular Maintenance	17
Troubleshooting	19
Follow-up Service	22
Specifications	24

General Parts

Water Heater

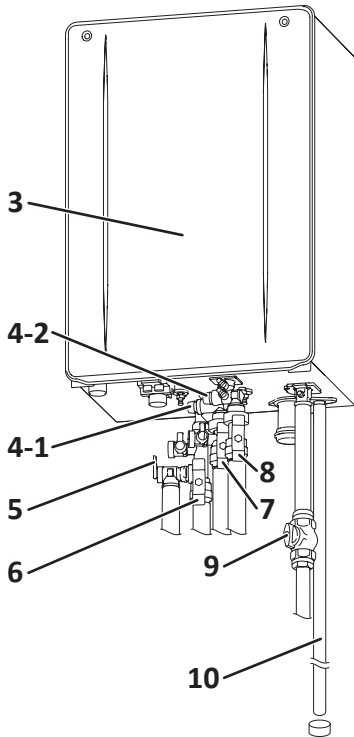

Indoor Installation

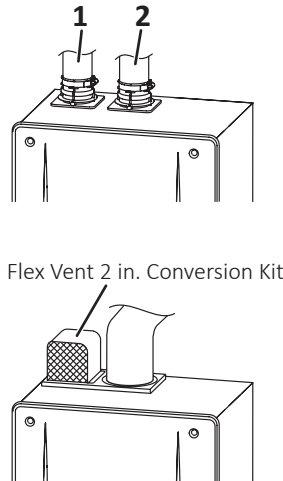

Outdoor Installation

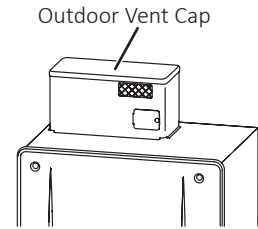

- 1. Intake Pipe**
- 2. Exhaust Pipe**
- 3. Front Cover**
- 4. Water Drain Valve (with Water Filter)** (See page 18)
4-1: Inside the cold water inlet
4-2: Inside the hot water return
- 5. Pressure Relief Valve**
- 6. Hot Water Valve**
- 7. Water Supply Valve**
- 8. Hot Water Return Valve**
- 9. Gas Supply Valve**
- 10. Condensate Drain Pipe**
Discharge the condensate.

This illustration shows an example of installation.
The exact installation configuration may be slightly different.

The condensing tankless gas Water Heater discharges condensate.

When heat from the exhaust gas is collected within the secondary Heat Exchanger, condensation occurs from moisture in the exhaust gas and the resulting water is discharged from the condensate drain pipe (approximately 2 gallons/h (7.5 L/h) maximum). It is not a water leak. Do not plug or block the drain line as it must always be allowed to freely flow.

Note : The condensate discharged is acidic with a pH level of approximately 2-3. A condensate neutralizer may be required by local code prior to disposal.

The condensing tankless gas Water Heater tends to emit white steam.

After the exhaust gas passes through the secondary Heat Exchanger, the low temperature and high moisture content tends to produce steam at the vent discharge terminal.
This is a normal occurrence.

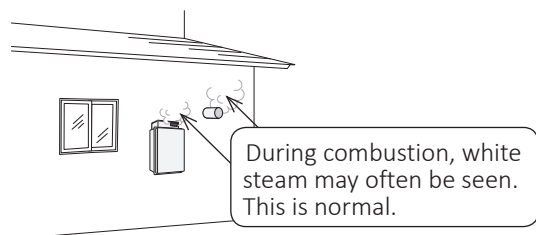

Remote Controller (RC-7651M-A)

- What is actually displayed depends on how the Water Heater is set.
- Before use, remove the protective sheet from the Remote Controller surface.

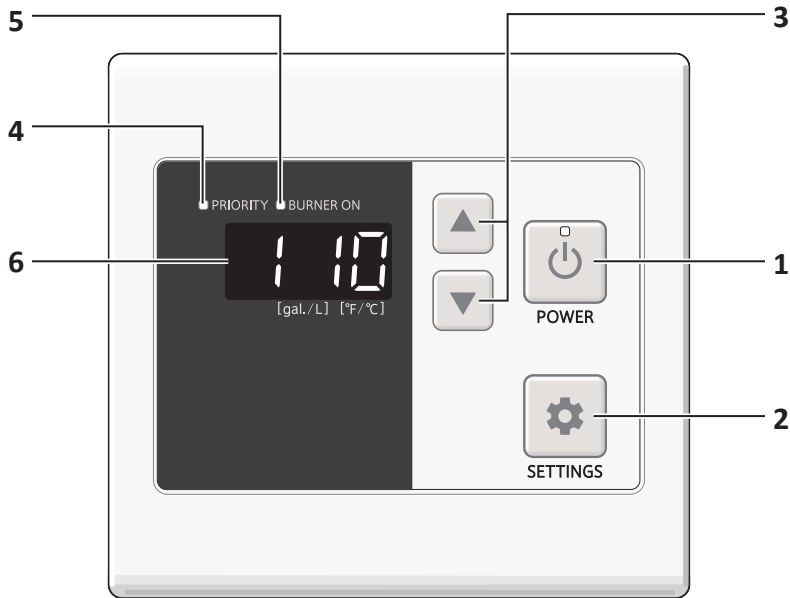

1. POWER Button / Indicator

For turning the Water Heater ON/OFF.

2. SETTINGS Button

For setting the flow meter alarm, and other settings.

3. ▲ / ▼ Buttons

For setting the hot water temperature, the flow meter alarm, and other settings.

4. PRIORITY Indicator

When this indicator is displayed, the hot water temperature can be set.

5. BURNER ON Indicator

When burning, the indicator is displayed.

6. - Temperature Setting (e.g. 110°F)

- Flow Meter Setting (See page 12)

- Error Code

A number will blink if a failure occurs.

(See page 21)



NOTE As shipped from the factory, the Remote Controller is set to display in °F and gallons. To adjust the display to °C and liters, refer to the Installation Manual.

Features of the Auto-Recirculation Mode

Hot water recirculation system: The Water Heater circulates and warms up the hot water in the pipe. When recirculation is operating, you can get hot water more instantly with less waste of water.

About “Auto-Recirculation”

- The Water Heater learns the usage pattern of hot water usage.
- The Water Heater operates recirculation on the usage pattern automatically from next day.

- NOTE**
- As an energy savings feature, if you leave the  button on and hot water is not used for more than 3 days, the stored recirculation operation will be reset. To avoid this, turn the  button off the Remote Controller when hot water will not be used for prolonged times (i.e. vacation).
 - Auto-Recirculation Mode doesn't operate when using On-Demand Mode.
 - You can manually stop the Recirculation operation. (See page 13)

Initial Operation

Before the first use, do the following:

1. Open the water supply valve.

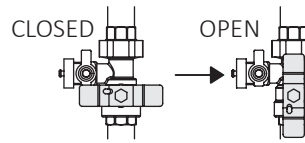

2. Open a hot water fixture/faucet to confirm that water is available, and then close the fixture/faucet again.

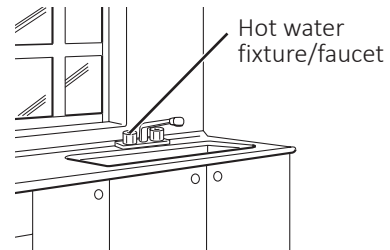

3. Open the gas supply valve.

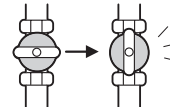

4. Turn on the power.

WARNING

Do not touch the power cord with wet hands.

Using the Water Heater

Operation

1. The  button is ON.

PRIORITY indicator is displayed.

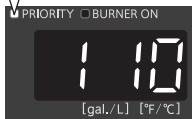

(e.g. 110°F)

- The POWER indicator is displayed.
- The previously set hot water supply temperature is shown.
- The setting temperature displayed may vary from the actual temperature at the fixture depending on conditions such as season or length of piping.

2. Turn on hot water.

BURNER ON indicator is displayed during combustion.

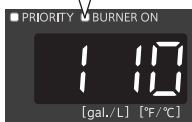

- Turn off hot water, the BURNER ON indicator disappears.

DANGER

- **To prevent scalding :**
Hot Water Heater temperatures over 125°F (52°C) can cause severe burns instantly or death from scalding.
- Children, disabled and elderly are at the highest risk of being scalded. Feel water temperature before bathing or showering. Temperature limiting valves are available, consult with installer.
- When setting the Water Heater to 125°F (55°C in °C mode) or higher, the temperature display will blink for 10 seconds and emit a tone as a high temperature warning.
- Take caution when using the Water Heater again after setting to 125°F (52°C) or higher. Always check the set temperature before use.
- Do not allow anyone to change the water temperature while hot water is running.

Setting Hot Water Temperature

Operation

- The  button is ON.

PRIORITY indicator is displayed.



(e.g. 110°F)

- The POWER indicator is displayed.
- The previously set hot water supply temperature is shown.

- Set the temperature using the ▲/▼ buttons.



(e.g. 105°F)

- NOTE**
- Hot water temperatures shown are approximate and may differ from the actual temperature at the fixture depending on external factors such as the season and length of piping in the system.
 - When low temperatures are set (for washing dishes, etc.), if the incoming water temperature is already quite high, it may be difficult to ensure the outgoing water temperature is as per the setting.
 - Check the temperature displayed before using any hot water. Be especially careful using hot water after the set temperature has been changed.
 - When the hot water temperature is adjusted using thermostatic water mixing valves, set the temperature on the Remote Controller approximately 20°F (10°C) higher than the required temperature to ensure the appropriate fixture temperature.
 - For most residential applications, the recommended setting temperature is 120°F (50°C in °C mode) or less.
 - The setting temperature can be set to only 120°F (49°C in °C mode) or higher when using "Crossover Valve mode".

Temperature Setting Options

The temperature settings below are examples. The temperature setting necessary depends on the usage, the length of piping and the season.

[When using °F mode] (Default setting is 110°F)

100°F	Washing dishes, etc.
105°F	
110°F	Shower, hot water supply, etc.
115°F	
120°F	
125°F	High temperature*
130°F	(The maximum output temperature can be set using the Remote Controller. (See page 12))
135°F	
140°F	

[When using °C mode] (Default setting is 40°C (104°F))

37°C (99°F)	Washing dishes, etc.	
38°C (100°F)		
39°C (102°F)	Shower, hot water supply, etc.	
40°C (104°F)		
41°C (106°F)		
42°C (108°F)		
43°C (109°F)		
44°C (111°F)		
45°C (113°F)		
46°C (115°F)		
47°C (117°F)	High temperature*	
48°C (118°F)		(The maximum output temperature can be set using the Remote Controller. (See page 12))
50°C (122°F)		
55°C (131°F)		
60°C (140°F)		

* Display when high temperature is set

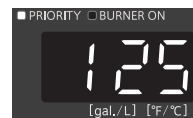

(e.g. 125°F)

Blink for 10 seconds





- NOTE**
- Consult local codes for minimum operating temperatures.
 - Noritz recommends that water temperature is set as low as possible to prevent scale build-up in the Heat Exchanger.

Customizable Settings

Limiting the Maximum Output Temperature

The maximum output temperature can be limited to prevent discharging hot water at too high of a temperature.

Operation

1. The  button is OFF.
2. Press and hold the  button until a sound is heard (approximately 2 seconds).
3. Change the temperature using the  /  buttons. (Setting completed.)

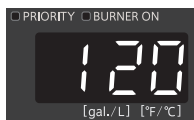

(e.g. 120°F)

[For Fahrenheit (°F)]
100 - 140°F (In 5°F intervals)
[For Celsius (°C)]
37- 48°C (In 1°C intervals),
50- 60°C (In 5°C intervals)

(Default setting = 120°F/50°C)

- Set the  button to ON when continuing to use the unit as is. Otherwise, let the unit sit for approximately 30 seconds.

Muting the Remote Controller

The Remote Controller will emit a sound when any button is pressed. This sound can be muted if it is desired.

Operation

1. Press and hold the  button for 5 seconds.

[Muted]
No sound after 5 seconds
[Sound]
The sounds after 5 seconds







(Default setting = Sound)

- The flow meter alarm cannot be muted.
- The high temperature warning tone when setting the unit to 125°F/55°C (131°F) or higher will not emit a sound when muted.

Flow Meter Alarm

The flow meter alarm is being used to indicate when a tub is full.

Operation

1. The  button is ON.
 - Check the current setting temperature.
2. Set the temperature using the  /  buttons.
3. Press the  button, and adjust with the  /  buttons.
 - The flow meter setting will be blinking.

[For gallon]
10- 60 gal (In 5 gal intervals),
60- 100 gal (In 10 gal intervals),
990 gal
[For liter]
40- 240 L (In 20 L intervals),
240- 380 L (In 40 L intervals),
990 L



(Default setting = 990 gal (990 L))

- The alarm will not sound if it is set for 990 gal (990 L).
 - The level can only be adjusted while the flow meter setting is blinking.
 - After 10 seconds, the Remote Controller will again display the temperature.
4. Turn on hot water.
 - When the tub fills with the preset volume of water, an alarm will sound alerting you to shut off the water.
 5. Turn off the hot water when the alarm sounds to prevent overfilling.

- NOTE**
- The hot water filling temperature is same as the setting temperature.
 - Although the temperature can be set to 125°F/50°C or higher, do not set the temperature to 125°F/50°C or higher as it can cause severe burns instantly or death from scalding.

Stopping Recirculation Operation

Operation

1. The  button is OFF.
2. Press and hold the  button until a sound is heard (approximately 2 seconds).
 - The maximum hot water temperature will blink.





(e.g. 120°F)

3. Press the  button several times until the item number "4" is displayed.



(e.g. on)

4. Change the setting using the  /  buttons. (Setting completed.)

on: Recirculation on oF: Recirculation off

(Default setting = on)

- Set the  button to ON when continuing to use the unit as is. Otherwise, let the unit sit for approximately 30 seconds.

Preventing Damage from Freezing

NOTICE

- Damage can occur from frozen water within the appliance and pipes even in warm environments. Be sure to read below for appropriate measures.
- Repairs for damage caused by freezing are not covered by the warranty.

Freezing is prevented within the device automatically by the freeze prevention heater and pump.

Freezing cannot be prevented when the power plug is unplugged. Do not remove the power plug from the wall outlet.

Freezing will be prevented regardless of whether the  button is ON or OFF.

- In normal operation, freezing is prevented within the Water Heater automatically unless the outside temperature without wind is below -30°F (-35°C) when supplying combustion air from the outdoor (Direct Vent) or -4°F (-20°C) when the Water Heater is installed outdoors.
- For indoor installation, when supplying combustion air from the indoors, the room temperature must be greater than 32°F (0°C) to prevent freezing and the room inside must not have negative pressure.
- The freeze prevention heaters will not prevent the plumbing external to the Water Heater from freezing. Protect this plumbing with insulation, heat tape or electric heaters, solenoids, or pipe covers. If there remains a freezing risk, contact the nearest Noritz agent.

Take the measures below for extremely cold temperatures*.

* Outside temperature including wind chill factor less than -30°F (-35°C) when supplying combustion air from the outdoor (Direct Vent) or -4°F (-20°C) when the Water Heater is installed outdoors.

This method can protect not only the Water Heater, but also the water supply, water piping and mixing valves.

1. Turn off the  button.
2. Close the gas supply valve.
3. Open a hot water fixture/faucet, and keep a small stream of hot water running. (0.1 gallon (400 mL)/minute or about 0.2 in. (4 mm) thick.)
 - If there is a mixing valve, set it to the highest level.
 - When linking multiple Water Heaters, discharge water equivalent to (0.1 gallon (400 mL)/minute per Water Heater.)
4. The flow may become unstable from time to time. Check the flow 30 minutes later.
 - In general, it is not advisable to run water through the Water Heater when it is OFF (See page 5), but in this case freeze prevention is more important.

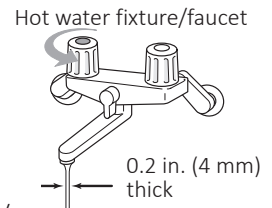

- NOTE**
- Remember to set mixing valves and fixtures to their original levels before using the Water Heater again to prevent scalding.
 - If there is still a risk that the Water Heater will freeze, drain the Water Heater as shown on the next page.

If water will not flow because it is frozen

1. Close the gas and water valves.
2. Turn off the  button.
3. Open the water supply valve from time to time to check whether water is running.
4. When the water is flowing again, check for water leaks from the Water Heater and piping before using.

NOTE If the Water Heater or the piping is frozen, do not use the Water Heater or it may get damaged.





If the Water Heater will not be used for a long period of time, drain the water.

⚠ WARNING

- To prevent burns or scalding, turn off the  button and wait until the appliance cools before performing maintenance.
- Do not touch the power cord with wet hands.

- To prevent damage from freezing, the Water Heater must be plugged into power at all times. If power is unplugged, drain the water completely from the Water Heater. Then use an air compressor to remove all water from inside the water piping of the Water Heater.
- It is recommended that Isolation Valves are installed on the Water Heater, otherwise the water connections will need to be removed to drain the Water Heater completely.
- Freeze damage due to not draining properly will not be covered under warranty.
- Drain water into a bucket to prevent water damage.

Drain Using the Remote Controller

1. The  button is OFF.
2. Press and hold the  button until a sound is heard (approximately 2 seconds).
 - The maximum hot water temperature will blink.
3. Press the  button several times until the item number "5" is displayed.
4. Press the  button.
 - The display will change from "oF" to "on".
5. Close the water supply valve.

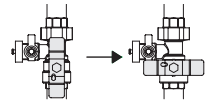
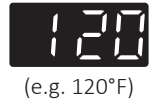

6. Fully open all hot water fixtures/faucets.

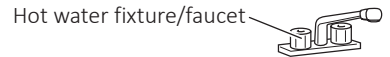

7. Open drain plug (A) on the hot water side. Or open the port (a) and small valve (b) of isolation valve on hot water side.

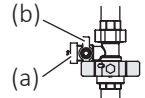

8. Open drain plug (with filter) (B) on the cold water side. Or open the port (a) and small valve (b) of isolation valve on cold water side.
9. Open other drain plugs (C, D, E, F) and wait until finish draining water.

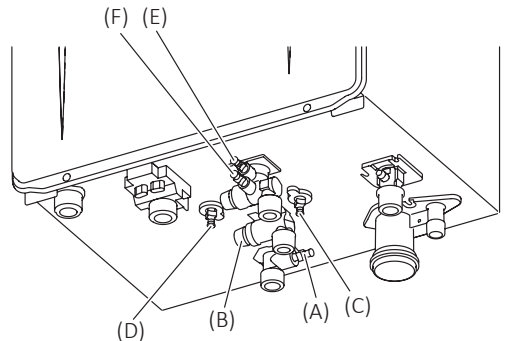

10. When the water is completely drained, reattach all drain plugs and close the hot water fixtures/faucets.
11. Close the gas valve and disconnect the electrical power supplied to the Water Heater.

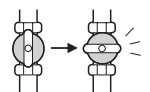

Do not touch with wet hands.

Manual Draining

1. Close the gas valve.

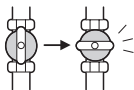

2. The  button is ON.
3. Turn and leave open the hot water fixtures/faucets for more than 2 minutes and close.



- If multiple Water Heaters are being used, drain 2 minutes for each Water Heater.
 - An 11 Error Code may appear on the Remote Controller. This is not a malfunction of the Water Heater. Do not turn the  button OFF.
4. Close the water supply valve and disconnect the electrical power supplied to the Water Heater.

Do not touch with wet hands.

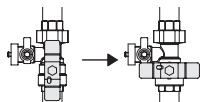

5. Fully open all hot water fixtures/faucets.
6. Open drain plug (A) on the hot water side. Or open the port (a) and small valve (b) of isolation valve on hot water side.
7. Open drain plug (with filter) (B) on the cold water side. Or open the port (a) and small valve (b) of isolation valve on cold water side.
8. Open other drain plugs (C, D, E, F) and wait until finish draining water.

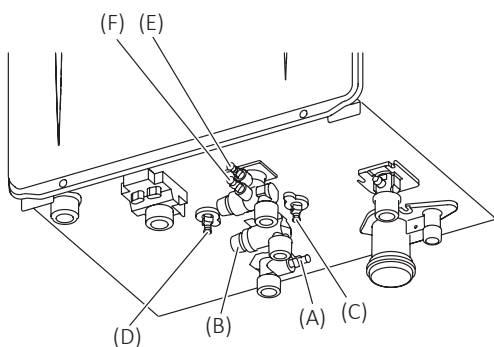
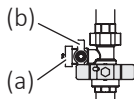

9. When the water is completely drained, reattach all drain plugs and close the hot water fixtures/faucets.

Turning the Water Heater Back On

DANGER

After the Water Heater has been out of use for a long time, make sure that you fill the condensate trap with water.

This is to prevent dangerous exhaust gases from entering the building.

Failure to fill the condensate trap could result in severe personal injury or death.

(By performing step 4 as described below, the condensate trap will automatically fill itself with water.)

WARNING

Do not touch the power cord with wet hands.

1. Check that all drain plugs are inserted.
 2. Check that all hot water fixtures/faucets are closed.
 3. Open the water supply valve.
 4. Open a hot water fixtures/faucets to confirm that water is available, and then close the hot water fixtures/faucets again.
 5. Open the gas supply valve.
 6. Connect the electrical power.
- Do not touch with wet hands.**
7. Make sure that the area around the appliance is well ventilated; open a window or a door if necessary. Then, operate the Water Heater and verify that condensate is coming out of the condensate drain pipe. (During normal use of the Water Heater, condensate will begin to discharge from the condensate drain pipe within 15 minutes of use. However, depending on the season and/or installation site conditions, it may take longer.)

NOTE If water does not appear at the end of the drain line, a qualified service technician must clean the condensate line.

Regular Maintenance

Periodic Inspection

Periodic check and maintenance should be performed once a year by a qualified service technician to assure that all the equipment is operating safely and efficiently.

We recommend to make necessary arrangements with a service contractor.

⚠ WARNING

To prevent burns or scalding, turn off the  button and wait until the appliance cools before performing maintenance.

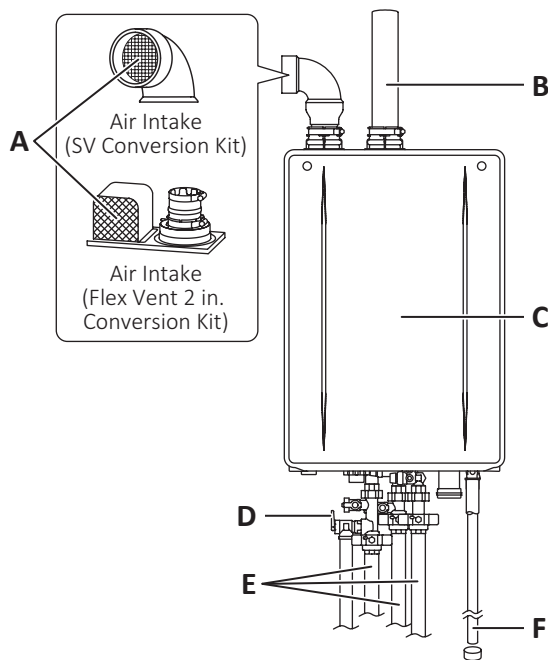

Check : A

[When supplying combustion air from the indoors]
For smear or blockage with dust, oil, etc. at the air supply vent.

If blocked, remove the build-up with a vacuum cleaner or damp towel.

NOTE Do not permanently remove the Inlet Screen.

Check : B

For dust and soot in the exhaust vent or the exhaust vent terminal.

Check : C

- For abnormal sounds during operation.
- For abnormalities in external appearance, discoloration or flaws.

Check : D

For proper operation of pressure relief valve.

Check : E

For water leaks from the Water Heater and piping.

Check : F

For blockage at the condensate drain pipe discharge.

Check

For laundry, newspaper, timber, oil, spray cans and other combustible materials near the Water Heater or the exhaust vent terminal.

Periodic Maintenance

Water Heater

Wipe the outside surface with a wet cloth, then dry the surface. Use a neutral detergent to clean any stains.

If an external condensate neutralizer is installed, periodic replacement of the neutralizing agent will be required. Refer to the instructions supplied with the neutralizer for suggested replacement intervals.

Remote Controller

Wipe the surface with a wet cloth.

- NOTE**
- Do not use chlorine-based, acidic, alkaline detergents, organic solvents such as benzine and thinner, or Melamin Sponge to clean the Remote Controller.; discoloration, deformation, scratches or cracks may occur.
 - The Remote Controller is water resistant but not water proof. Keep it as dry as possible.

Water Drain Valve (with Water Filter)

If the water drain valve (with water filter) is covered with debris, the hot water may not run smoothly, or the Water Heater may put out cold water. Check and clean the filter as explained below.

⚠ WARNING

To prevent burns or scalding, turn off the  button and wait until the appliance cools before draining the water.

1. Close the hot water valve, the water supply valve, and the hot water return valve.

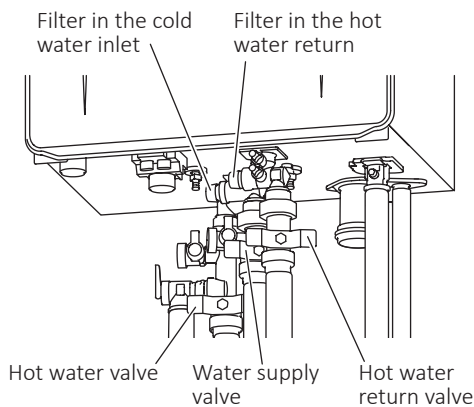
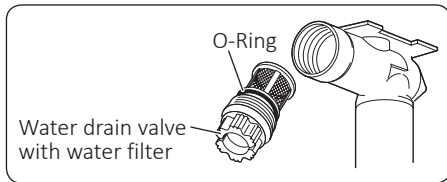

2. With a bucket ready, remove the water drain valves.

NOTE Approximately 0.85 gallon (3.2 L) of water will drain out.

3. Clean each water filter with a brush under running water.
4. Reattach the water drain valves (with water filter).

NOTE Do not lose the O-Ring.

5. Open the hot water valve, the water supply valve, and the hot water return valve. Check that water does not leak from the water drain valves.

Water Quality and Maintenance

- For people who live in a hard water area, periodic flushing is necessary. If the Heat Exchanger is not flushed, the Scale Build-up may cause damage to the Heat Exchanger. To prevent damage to the Heat Exchanger, the Heat Exchanger regularly needs to be flushed.
- This Water Heater is equipped with an automatic service reminder to announce for flushing the Heat Exchanger. The factory default of this service reminder is disable. If desired, the customer or installer needs to enable the service reminder (connect the red connector marked "SERVICE REMINDER"). Refer to the "Water Treatment: About the Service Reminder" in the Installation Manual.
- If the service reminder is selected to ON, the code "C1#" (#=1,2,3,4 ... 9) will displayed on the Remote Controller after the set time period has been reached. When the code is displayed, the Heat Exchanger needs to be flushed to prevent damage from Scale Build-up. Refer to the "Procedure for flushing the Heat Exchanger" in the Installation Manual or contact Noritz America for more information. (<http://support.noritz.com/> or 1-866-766-7489)
- Damage to the Water Heater as a result of below is not covered by the Noritz America Limited Warranty. To ensure full warranty coverage, treat or condition water that exceeds the target levels provided in this table.
 - Water in excess of 12 gpg (200 mg/L) of hardness
 - Poor water quality (see the following table)
 - The Water Heater has displayed a "C1#" (Service Reminder) indicating Scale Build-up, but the Heat Exchanger has not been flushed.

Contaminant	Maximum Allowable Level
Total Hardness*	200 mg/L (12 gpg) or less
Aluminum	0.05 to 0.2 mg/L or less
Chloride	250 mg/L or less
Copper	1.0 mg/L or less
Iron	0.3 mg/L or less
Manganese	0.05 mg/L or less
pH	6.5-8.5
Total Dissolved Solids	500 mg/L or less
Zinc	5 mg/L or less
Sulfate	250 mg/L or less
Residual chlorine*	4 mg/L or less

Source: EPA National Secondary Drinking Water Regulations (40 CFR Part 143.3)

* Maximum limit suggested by Noritz.

Troubleshooting

Initial Operation

The Water Heater does not attempt to ignite when water is running.

- Check for reversed plumbing or crossed pipes.
- Check the water filter. (See page 18)

The Water Heater attempts to ignite but fails.

- Reset the Water Heater and try again. There may be air in the gas line.
- Have a professional check the gas supply pressure.

Remote Controller

The POWER indicator does not light up.

- Has there been a power failure?
- Is the power connected properly?

The water temperature changes after a power failure or when the power is disconnected.

- The temperature setting and the flow meter alarm setting may both need to be reset after a power outage.

The plastic on the surface or buttons of the Remote Controller has torn, peeled, or air bubbles inside.

- The surface of the Remote Controller is affixed with a protective sheet (to prevent surface scratching, etc.) at time of shipment. This sheet can be removed or left as it is. When leaving the protective sheet on, areas frequently touched may tear or peel. However, the Remote Controller will not malfunction from water entering such torn or peeled areas. To restore the appearance of the Remote Controller surface, simply remove the protective sheet.

Temperature

Hot water is not available when a fixture is opened.

- Are the gas and water supply valves fully open?
- Is the water supply cut off?
- Is the hot water fixture/faucet sufficiently open?
- Is the gas being cut off by the gas meter? (Can other gas devices such as stoves be used?)
- (For LP) Is there enough gas in the tank? (Can other gas devices such as stoves be used?)
- Is the water filter clogged? (See page 18)
- Is the  button turned ON?

No water is available when a fixture is opened.

- Is the water supply cut off?
- Is the Water Heater frozen?

The hot water is not the correct temperature.

- Is the hot water fixture/faucet sufficiently open?

Water takes time to become hot when turning the hot water fixture/faucet.

- Have you allowed enough time for the cold water in the pipes to drain out?

The water is too hot.

- Are the gas and water supply valves fully open?
- Is the water temperature setting appropriate? (See page 11)
- If the water supply temperature is high, it is possible for the temperature to be higher than the temperature set on the Remote Controller.
- If only a small amount of hot water is demanded, it is possible for the temperature to be higher than the temperature set on the Remote Controller.

The water is not hot enough.

- Are the gas and water supply valves fully open?
- Is the water temperature setting appropriate? (See page 11)
- If the amount of hot water required is very high, it is possible for the temperature to be lower than the temperature set on the Remote Controller. Decrease the amount of hot water passing through the Water Heater and the temperature should stabilize.

The water is cold when only a single fixture is open.

- The unit will not heat the water if the flow rate is less than 0.29 GPM (1.1 L/min)*. Open the fixture more or open other fixtures so that a greater flow passes through the unit, and the unit should begin heating again.
*Minimum activation flow rate: 0.5 GPM (2.0 L/min)
Minimum operating flow rate: 0.29 GPM (1.1 L/min)

Fluctuations in hot water temperatures.

- Set water temperature at 115°F to 120°F or 48°C (118°F) to 50°C (122°F). This will allow you to use a higher flow of hot water thus meeting the minimum flow requirement of 0.29 GPM (1.1 L/min)*.
*Minimum activation flow rate: 0.5 GPM (2.0 L/min)
Minimum operating flow rate: 0.29 GPM (1.1 L/min)
- Clean the water filter of any debris (See page 18)

Setting temperature cannot rise.

- Is the maximum temperature setting appropriate? (See page 12)

Amount of Hot Water

The amount of hot water at a certain fixture is not constant.

- When hot water is demanded at other fixtures, the amount available may be reduced.
The maximum flow available from NRCR111DV (GQ-C3260WXQ-FF US) is 8.7 GPM (33 L/min) at a 45°F (25°C) temperature rise.
The maximum flow available from NRCR92DV (GQ-C2660WXQ-FF US) is 7.1 GPM (27 L/min) at a 45°F (25°C) temperature rise.
- Pressure fluctuations and other plumbing conditions can cause the temperature and pressure at a fixture to be unstable, but it should stabilize after a short time.
- There are some types of hot water taps that discharges large volumes of hot water at first but stabilize after time.
- To keep the temperature stable, the Water Heater limits the amount of water that can flow through it to a small amount initially, but the amount increases over time.

The amount of hot water in the tub is less/more than the set amount.

- When hot water is used for other fixtures while filling the tub, the tub will not fill as much.
- If there is water in the tub already, or when filling is stopped and restarted, the tub will fill more.

The flow meter alarm does not sound even when filled to the set amount.

- The flow meter alarm is set to sound when hot water is continuously discharged for the set volume of water.
If mixing valves are used, or if cold water is mixed with hot water at the fixture, the tub will fill more than the setting of the flow meter alarm.

Amount of hot water available has decreased over time.

- Is the water filter clogged? (See page 18)
- If the supply water is hard and has not been treated, scale can build-up in the Water Heater and decrease the maximum amount of hot water available. Scale can be removed from the Water Heater by flushing the Water Heater periodically. To prevent scale from forming in the Water Heater, a water softener or scale inhibitor is recommended.

Hot Water Delivery

Hot water is taking too long.

- The Water Heater automatically learns based on water usage patterns. It may take several days to properly adjust to your schedule. Usage pattern may have also been reset if the Water Heater has not been utilized for 3 days or more. (Refer to page 9 for more details)

No recirculation activation.

- When using this Water Heater in On-Demand Mode, The Auto-Recirculation feature does not meet the requirements for this standard. To use the recirculation mode according to Title 24 standard, push the On-Demand Switch to manually operate the recirculation pump.

Recirculation operates with only cold water is being used.

- Check to see if the crossover valve is installed.
The crossover valve utilizes the cold water line as a return, allowing the system to function similar to a dedicated return line. The Water Heater will operate and learn the hot water usage.

Sounds

The fan can be heard after operation is stopped. A motor can be heard when turning the Water Heater on or off, when opening or closing a fixture, or after the Water Heater has been running for a while.

- These noises indicate the proper operation of devices which are designed to let the Water Heater reignite more quickly, and ensure the water temperature is stable.

The Water Heater makes noise when there is no hot water being used.

- The Water Heater operates automatically to recirculate water, prevent freezing or prevent stagnant water. It is not abnormal.

Other

The Water Heater stops burning during operation.

- Are the gas and water supply valves fully open?
- Is the water supply cut off?
- Is the hot water fixture/faucet sufficiently open?
- Is the gas being cut off by the gas meter? (Can other gas devices such as stoves be used?)
- (For LP) Is there enough gas in the tank? (Can other gas devices such as stoves be used?)

White smoke comes out of the exhaust vent on a cold day.

- This is normal. The white smoke is actually steam.

The hot water is turbid.

- This is harmless. Small bubbles appear as the air in the water is heated and depressurized rapidly to atmospheric pressure.

The water appears blue.

The tub/wash-basin has turned blue.

- Coloration to a blue color may be noticed from small traces of copper ion contained in the water and fat (furring). However, there are not problems concerning health. Coloration of the tub/wash-basin can be prevented by cleaning frequently.

Frequent water discharge from the condensate drain pipe.

- Condensation forms inside the Water Heater during operation and is discharged from the condensate drain pipe.

Check for an Error Code on the Remote Controller

When a failure occurs, information relating to the error blinks on the display. If this occurs, take appropriate measures as the following list.

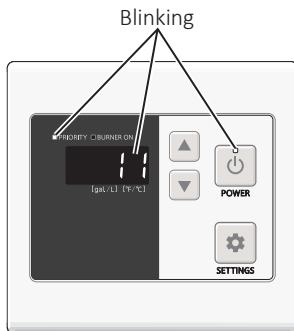

Error Code : 11

Cause : Ignition failure

Action : Check whether the gas valve is open. Press the  button to turn the Water Heater off, open a hot water fixture/faucet, and turn the Water Heater back on. If the blinking number doesn't return the problem is solved.

Error Code : 63

Cause : Recirculation Abnormality

Action : • Check return line filter.
• Check the crossover valve's filter.
• Contact Noritz America if there are any other questions.

Error Code : 90

Cause : [When supplying combustion air from the indoors]

The air supply vent may be clogged.

Action : Check air supply vent for blockage or obstruction. (See page 17)

Cause : Exhaust vent may be clogged.

Action : Check exhaust vent for blockage or obstruction.

Cause : Abnormal combustion, low gas supply pressure.

Action : Have a professional check the gas supply pressure.

Cause : Condensate drain line may be clogged.

Action : Check condensate drain line is clogged or frozen. If the display continues, contact nearest Noritz agent.

Error Code : 99

Cause : Abnormal combustion

Action : Contact the nearest Noritz agent.

Error Code : C1# (# = 1-9)

Cause : Service Reminder (Notice for periodic maintenance)

Action : This Water Heater is equipped with an automatic service reminder. Excessive scale build-up may cause premature failure of the Heat Exchanger. Excessive dust or lint build-up in the fan and air intake may affect efficiency and combustion performance.

Contact Noritz America for additional information about recommended maintenance procedures (1-866-766-7489).

Contact Noritz America if:

- Any other error code appears.
- An error code is indicated again after the above actions were followed.
- There are any other questions.

Follow-up Service

Requesting Service

First follow the instructions in the troubleshooting section. (See page 19-21)
If the error is not corrected, contact Noritz America Technical Support at 1-866-766-7489.

We will need to know:

- **The Model**
Check the rating plate (See page 4 for the location of the label)
- **Date of purchase**
See the warranty
- **Details of problem**
Blinking error codes, etc., in much detail as possible
- **Your name, address, and telephone number**
- **Desired date of visit**

NOTE A request for service may be rejected if the Water Heater is installed in a location where working on the Water Heater may be dangerous. Contact a plumber.

Warranty

A warranty registration card is included separately. Be sure that the installer name, date of purchase and other necessary items are filled in. Read the content carefully, and keep the warranty card in a safe place.

For repairs after the warranty period, there will be a charge on any service, and service will only be performed if the unit is deemed repairable.

Period of Time for Stocking Repair Parts

Noritz will stock repair and maintenance parts for this unit for the time period from the date of the original installation as follows: twelve (12) years for the Heat Exchanger and ten (10) years for remaining parts.

Reinstallation

If you want to reinstall the appliance at a different location, confirm that the gas and power supply indicated on the rating plate are available at the new location. If you are not sure, consult the local utility company.

Gas Conversion

- If you move to a region that uses a different type of gas or if the local gas supply is converted, replacement of the gas manifold and adjustment of the appliance will be necessary.
- This work must be performed by either Noritz or a qualified service agency and will be charged for even during the warranty period. The qualified installer will also be responsible for purchasing the gas conversion kit directly from the manufacturer.
- For more information, contact Noritz America Technical Support at 1-866-766-7489.

⚠ WARNING



- The gas conversion kit shall be installed by a qualified service agency* in accordance with the manufacturer's instructions and all applicable codes and requirements of the authority having jurisdiction.
- The information in the instructions must be followed to minimize the risk of fire or explosion or to prevent property damage, personal injury, or death.
- The qualified service agency is responsible for the proper installation of this kit.
- The installation is not proper and complete until the operation of the converted appliance is checked as specified in the manufacturer's instructions supplied with the kit.

* A qualified service agency is any individual, firm, corporation, or company which either in person or through a representative is engaged in and is responsible for the connection, utilization, repair or servicing of gas utilization equipment or accessories; who is experienced in such work, familiar with all precautions required, and has compiled with all of the requirements of the authority having jurisdiction.

1. Before the gas conversion is performed, verify the proper gas conversion kit with your Water Heater model on the table provided below.

Conversion Kit	Conversion Type
CK-82	Propane to Natural Gas
CK-83	Natural Gas to Propane

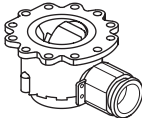
2. The following parts are supplied in the conversion kit. These items will replace the existing parts that are currently installed in the Water Heater.

Venturi Mixer Set	O-Ring (x 2)	Conversion Kit Label
		

- NOTE**
- Make sure that all parts are replaced and properly installed by a qualified service agency.
 - A Noritz Remote Controller and a digital gas manometer are required to complete the installation. Do not proceed if this Water Heater is not immediately available.

3. After the necessary parts have been replaced on the Water Heater, the Remote Controller is then used to adjust the settings on the Water Heater for use with the proper gas type.
4. The following pressure value are verified by the installer.
 - The inlet gas pressure value at the gas supply inlet fitting
 - The offset pressure value at the gas valve
5. Proper adjustments will be made to ensure safe and efficient operation.
6. Once this is completed, a final gas leak check will be performed to confirm that all parts have been securely installed.

- NOTE** If you notice the smell of gas at any time after the installation has been completed, turn the Water Heater off and contact your gas supplier immediately.

Specifications

- Specifications may be changed without prior notice.
- The capacity may differ slightly, depending on the water pressure, water supply, piping conditions, and water temperature.

Item		Specification	
Model Name		NRCR111DV (GQ-C3260WXQ-FF US) NRCR92DV (GQ-C2660WXQ-FF US)	
Type	Installation	Indoor / Outdoor Wall mounted	
	Air Supply / Exhaust	Power Vented	
Ignition		Direct Ignition	
Operating Pressure		15-150 psi (Recommended 50 to 80 psi for maximum performance)	
Minimum Activation Flow Rate*		0.5 GPM (2.0 L/min)	
Minimum Operating Flow Rate*		0.29 GPM (1.1 L/min)	
Dimensions (Height) × (Width) × (Depth)		27.0 in. (687 mm) × 18.5 in. (471 mm) × 14.1 in. (359 mm)	
Weight		73 lbs. (33 kg)	
Water Holding Capacity		0.85 Gallon (3.2 L)	
Connection Sizes	Water Inlet	NPT 3/4 in.	
	Hot Water Outlet	NPT 3/4 in.	
	Hot Water Return	NPT 3/4 in.	
	Gas Inlet	NPT 3/4 in.	
	Condensate Drain	NPT 1/2 in.	
Power Supply	Supply	120 VAC (60 Hz)	
	Consumption	NG: 218 W LP: 202 W Freeze Prevention: 114 W	NG: 185 W LP: 175 W Freeze Prevention: 114 W
	Maximum Current	4 Amps	
Materials	Casing	<ul style="list-style-type: none"> •Front Cover: Hot-dipped zinc-aluminum-magnesium-alloy-coated steel w/ Polyester Coating •Casing: Zincified Steel Plate / Polyester Coating 	
	Flue Collar	PP	
	Primary Heat Exchanger	Stainless Steel Sheeting, Stainless Steel Tubing	
	Secondary Heat Exchanger	Stainless Steel Sheeting, Stainless Steel Tubing	
Safety Devices		Flame Rod, High Limit Switch, Lightning Protection Device (ZNR), Freezing Prevention Device, Fan Rotation Detector	
Included Accessories		Remote Controller, Remote Controller Cord, Anchoring Screws, Wall Mounting Bracket	

* Minimum flow rate may change by setting temperature and water temperature.

Performances

Item	Performance				
	NRCR111DV (GQ-C3260WXQ-FF US)		NRCR92DV (GQ-C2660WXQ-FF US)		
		Maximum	Minimum	Maximum	Minimum
Gas Consumption	NG	199,900 Btu/h	18,000 Btu/h	165,000 Btu/h	18,000 Btu/h
	LP	199,900 Btu/h	18,000 Btu/h	165,000 Btu/h	18,000 Btu/h
Maximum Hot Water Capacity (45°F (25°C) Rise)		8.7 GPM (33 L/min)		7.1 GPM (27 L/min)	
Capacity Range		0.5-11.1 GPM (2-42 L/min)		0.5-9.2 GPM (2-35 L/min)	
Temperature Settings	°F Mode	100-140°F (In 5°F intervals) (9 Options)			
	°C Mode	37-48°C (In 1°C intervals), 50-60°C (In 5°C intervals) (15 Options)			