

KWIKSET SIGNATURE SERIES HANDLESET

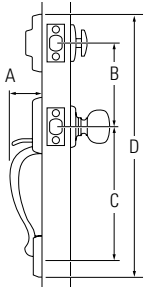

Design	A	B	C	D
Amherst®	3"	5-1/2"	8-13/32"	18-23/32"
Arlington®	2-17/32"	5-1/2"	11"	19-1/16"
Ashfield™	2-21/32"	5-1/2"	8-13/32"	17-3/4"
Avalon™	2-21/32"	5-1/2"	8-13/32"	18-5/32"
Chelsea®	2-5/32"	5-1/2"	9-11/16"	18-1/2"
Gibson®	2-7/16"	5-1/2"	9-11/16"	17-3/4"
Hawthorne™	2-7/8"	5-1/2"	8-13/32"	17-9/16"
Shelburne™	2-7/8"	5-1/2"	8-13/32"	18-1/4"
Sheridan®	2-3/4"	5-1/2"	11"	18-9/16"
Sonoma®	2-9/32"	5-1/2"	9-11/16"	17-1/8"
Wellington®	2-7/8"	5-1/2"	8-13/32"	18-15/16"

KWIKSET SIGNATURE SERIES LEVERS

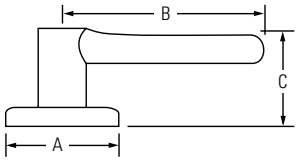

Design	A	B	C	C (Keyed)
Ashfield™	2-5/8"	4-3/16"	2-9/16"	2-7/8"
Avalon™	2-5/8"	4-1/4"	2-1/2"	2-7/8"
Brooklane®	2-5/8"	4-3/16"	2-3/16"	2-7/8"
Commonwealth®	2-5/8"	3-5/8"	1-15/16"	2-11/16"
Lido®	2-5/8"	3-3/4"	1-15/16"	2-5/8"
Pembroke™	2-5/8"	4-7/32"	2-7/16"	2-7/8"
Tustin®	2-5/8"	3-3/4"	1-15/16"	2-5/8"

KWIKSET SIGNATURE SERIES 980-985 DEADBOLT

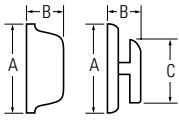

Design	A	B	C
980 Interior	2-9/16"	1-5/32"	1-13/16"
980 Exterior	2-5/8"	1-1/16"	
985 Interior	2-5/8"	1-1/16"	
985 Exterior	2-5/8"	1-1/16"	

KWIKSET SIGNATURE SERIES 780-785 DEADBOLT

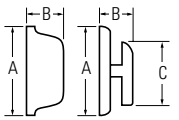

Design	A	B	C
780, 782 Interior	2-5/8"	1-1/16"	1-15/16"
780, 782 Exterior	2-5/8"	1-5/32"	
784, 785 Interior	2-5/8"	1-5/32"	
784, 785 Exterior	2-5/8"	1-5/32"	

KWIKSET SIGNATURE SERIES KNOBS

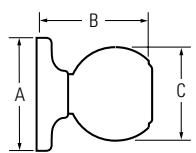

Design	A	B	C
Abbey®	2-5/8"	2-3/4"	2-1/32"
Cameron®	2-5/8"	3"	2-1/8"
Circa®	2-5/8"	2-3/4"	2-1/8"
Copa®	2-5/8"	2-3/8"	2-1/8"
Hancock®	2-5/8"	2-3/4"	2-3/8"
Laurel®	2-5/8"	2-5/8"	2-7/16"
Phoenix®	2-5/8"	2-1/4"	2-3/16"

SMARTCODE®

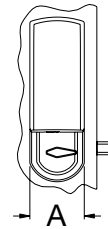

Inner Trim

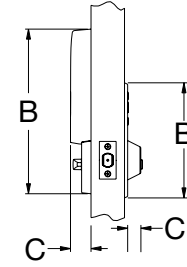

Outer Trim

Design	A	B	C
Outer Trim		6-7/8"	1-5/32"
Inner Trim	3-1/4"	9-13/16"	1-3/16"

SMARTSCAN®

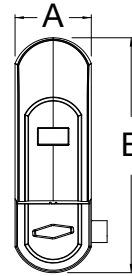

Inner Trim

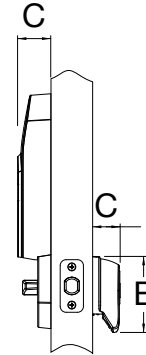

Outer Trim

Design	A	B	C
Outer Trim		3-1/4"	1-3/16"
Inner Trim	3-1/4"	10"	1-7/16"

SMARTCODE SIGNATURE SERIES™

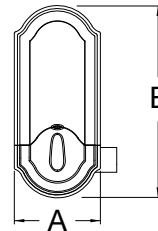

Inner Trim

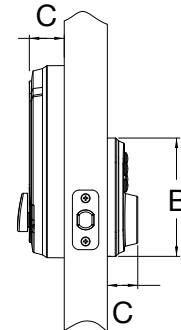

Outer Trim

Design	A	B	C
Outer Trim		4-7/16"	1-5/32"
Inner Trim	3-1/4"	7-3/16"	1-5/16"

KWIKSET HANDLESET

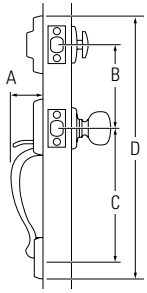

Design	A	B	C	D
Dakota™	2-1/2"	5-1/2"	8-13/32"	17-5/8"
Farmington®	2-9/16"	5-1/2"	8-13/32"	17-7/16"

KWIKSET KNOB

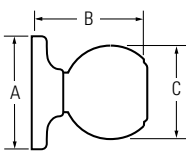

Design	A	B	C
Cove™	2-5/8"	2-19/32"	2-1/4"
Polo®	2-5/8"	2-7/8"	1-7/8"
Tylo®	2-5/8"	2-19/32"	1-7/8"

KWIKSET LEVER

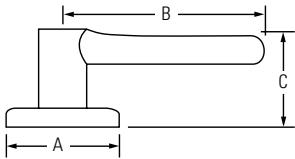

Design	A	B	C	C (Keyed)
Delta®	2-5/8"	3-5/8"	1-15/16"	2-5/8"
Dorian®	2-5/8"	3-3/4"	2-1/4"	2-5/8"

KWIKSET DEADBOLT

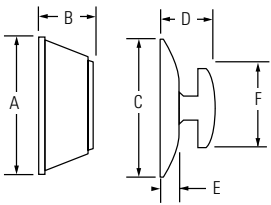

Design	A	B	C	D	E	F
660	2-1/2"	1-1/8"	2-1/2"	1"	3/8"	1-3/4"
663			2-1/2"	1"	3/8"	1-3/4"
665	2-1/2"	1-1/8"	2-1/2"	1-1/8"		
667	2-1/2"	3/8"	2-1/2"	1"	3/8"	1-3/4"
677	2-1/2"	3/8"	2-1/2"	1"	3/8"	1-3/4"

INTERCONNECT

Door Prep	Crossbore 2 1/8" Edge Bore 1" 5-1/2" center-to-center only.
Backset	Complete locksets: 2-3/4" UL or 2 3/8" UL - must specify Interior Assemblies: Determined by handleset ordered.
Door Thickness	1-3/4" and 2-1/4".
Cylinder	506, 508 - utilize 6-pin on 780 deadbolt. 505, 507 - utilize 5-pin on 660 deadbolt. 502, 499, 503 - determined by handleset ordered. Also available in SmartKey.
Faceplate	Complete locksets: No default—must specify faceplate. 1" round corner, 1" square corner, 1-1/8 WFL square. Interior assemblies: determined by handleset ordered. Complete locksets: UL 3028, 3031, (WFL option 3846).
Strikes	Deadbolt Strike: UL 5278, 3223 (WFL 4632 opt.). Interior assemblies: determined by handleset ordered.
Handing	506, 508, 505, 507 - reversible. 502, 499, 503 - specify handing.
ANSI/BHMA	506, 508, 503 - Grade 2 505, 507 - Grade 3 502 - Determined by handleset ordered. 499 not applicable.
ADA	All lever options meet 4.12.9 ADA requirements.
UL	Meets 3 hour fire rating for all UL functions.

INTERCONNECT

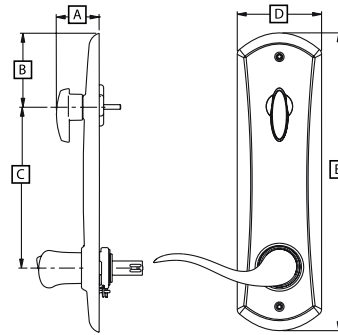

Design	A	B	C	D	E
Interconnect	1-27/64"	2-15/32"	5-3/8"	2-53/64"	9-63/64"

KINGSTON LEVER

Door Prep	Crossbore 2-1/8" Edge Bore 1" Latch Face 1" x 2-1/4" Optional: 1-1/8" x 2-1/4" UL.
Backset	Adjustable to 2-3/8" or 2-3/4" UL 2-3/4" standard, 2-3/8" optional.
Door Thickness	1-3/8" – 1-3/4" doors standard. 2-1/4" optional passage and entry functions.
Cylinder	Pin & Tumbler and SmartKey.
Faceplate	1" x 2-1/4". Specify round corner, square or drive-in. UL 1-1/8" square optional.
Latches	Adjustable to 2-3/8" or 2-3/4". Specify round corner, RFL.
Strikes	2-1/4" full lip. Specify round corner or square corner. Other options available. UL options include 2-3/4" T-Strike and 4-7/8" ASA.
Door Handing	Reversible for right or left-hand doors.
ANSI/BHMA	Non-handed. A156.2 Grade 2.
ADA	Lever functions satisfy 4.13.9 ADA requirements.
UL	Meets 3 hour fire rating for all UL functions.