

Elwick

RAD-N-xx-OF + ELW-B-xx-OF

volcanic limestone baths

Top view

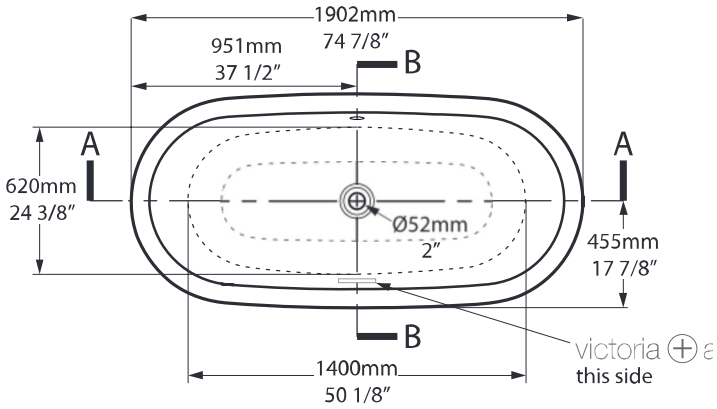

Front view

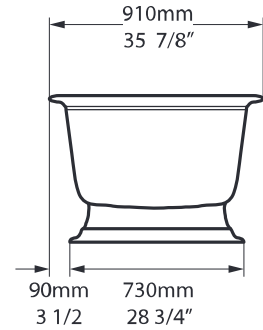

Side view

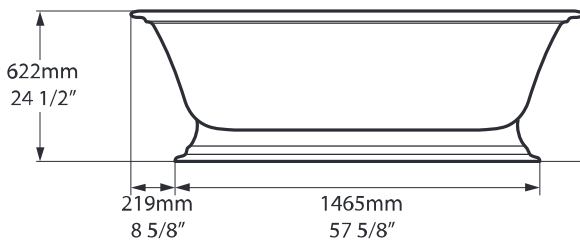

Section BB Shown with K50 waste kit

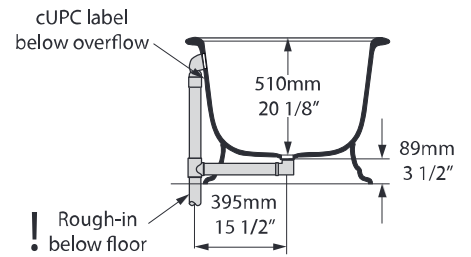

Section AA

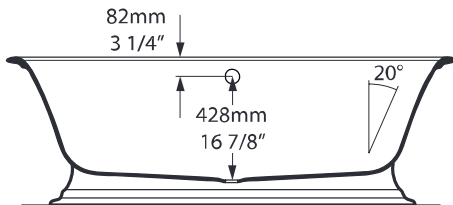

Rim Detail

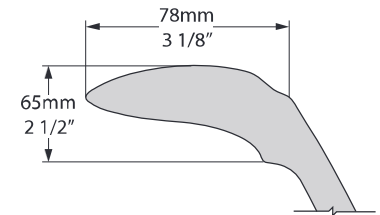



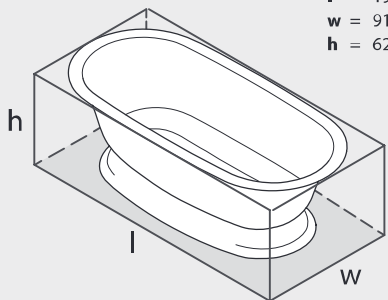

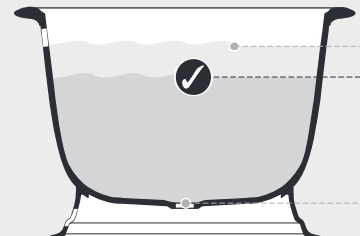

*All measurements subject to +/-5% tolerance



l = 1902mm / 74⁷/₈"
w = 910mm / 35⁷/₈"
h = 622mm / 24¹/₂"



 915	 84½ US gal
 595	 46¼ US gal
 209	 0 US gal

