

INSTALLATION GUIDE

GB-1000 100 GPM Grease Interceptor for Indoor/Outdoor Use

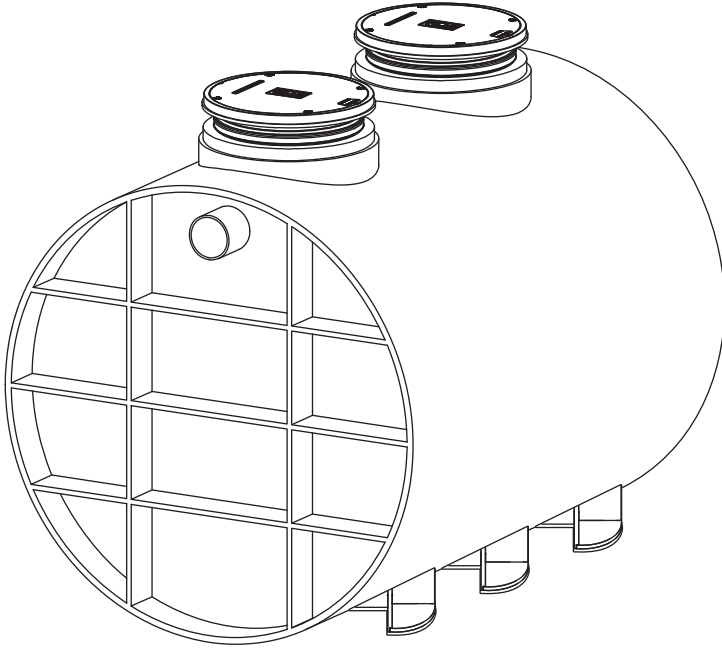

Contents

Special Precautions	2-3
Installation Instructions	4-7
Installation Options	8



SCHIER
LIFETIME GUARANTEED
GREASE INTERCEPTORS



SPECIAL PRECAUTIONS

For Schier Grease Interceptor Installations - Failure to follow this guidance voids your warranty

WARNING! DO NOT AIR TEST UNIT OR RISER SYSTEM! Doing so may result in property damage, personal injury or death.

CAUTION! Do not install this unit in any manner except as described in these instructions.

Installation Instructions

Installation instructions and additional components are included with the interceptor. Read all instructions prior to installation. This interceptor is intended to be installed by a licensed plumber in conformance with all local codes.

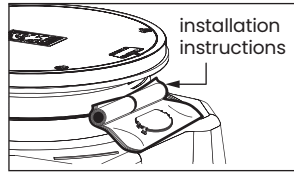

When Installing Interceptor Inside

If your dishwashing sink(s) discharges into a floor drain/sink (drain), you must regulate the flow into the drain to avoid an overflow of water onto the kitchen floor. This can be done by installing a valve or flow restriction cap on the sink piping that discharges into the drain.

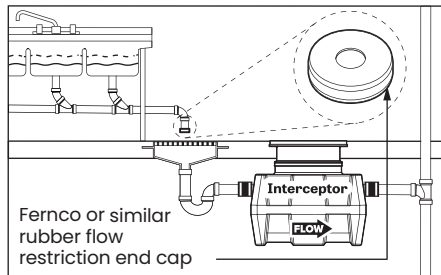

See drawing for guidance. For detailed guidance on indirect connections, go to: webtools.schierproducts.com/Technical_Data/Indirect_Connections.pdf

Hydrostatic Slabs (or Pressure Slabs)

When installed under a hydrostatic slab (slab designed to withstand upward lift, usually caused by hydrostatic pressure) interceptor must be enclosed in a watertight concrete vault.

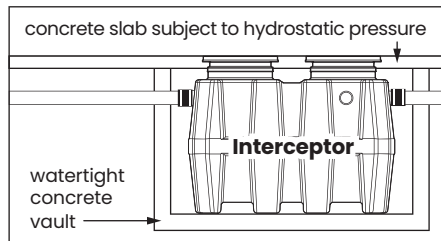

High Temperature Kitchen Water

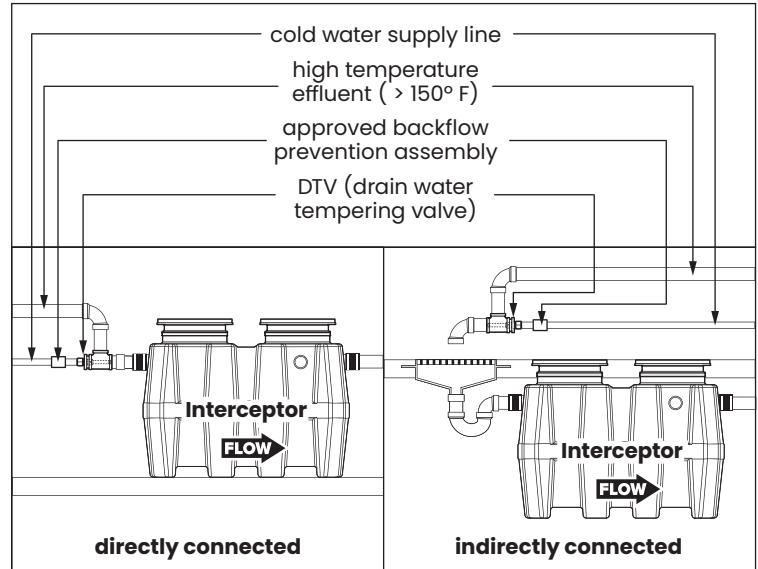

If water is entering the interceptor at excessive temperature (over 150° F), a drain water tempering valve (DTV) and approved backflow prevention assembly must be installed. Most state and local plumbing codes prohibit water above 150° F being discharged into the sanitary sewer. Water above 150° F will weaken or deform PVC Schedule 40 pipe, poly drainage fixtures like interceptors and erode the coating of cast iron (leading to eventual failure).



SPECIAL PRECAUTIONS

For Schier Grease Interceptor Installations – Failure to follow this guidance voids your warranty

High Water Table Installations

Interceptors and risers are not designed to withstand water table height in excess of the top of the unit when buried (see figure). If it is possible for this to occur, install the interceptor and risers in a water-tight concrete vault or backfill with concrete or flowable fill (wet concrete and flowable backfill should be poured in stages to avoid crushing the interceptor). At risk areas include but are not limited to tidal surge areas, floodplains and areas that receive storm water. Great Basin™ models that are direct buried in high water table scenarios must be installed with an anchor kit. Models GB-50, GB-75, and GB-250 use model AK1 anchor kit. Model GB-500 uses model AK2 anchor kit for use with deadmen anchors. Models GB-1000, GGI-750 and GGI-1500 use model AK3 anchor kit for use with deadmen anchors.

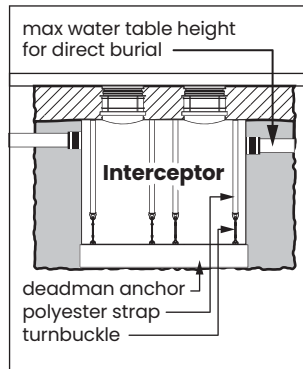

Above Grade Installation Support (for Model GB-500 Only)

The wet weight of the interceptor combined with high temperature kitchen water creates the potential for tank deformation when installed above grade. Model GB-500 installed above grade must be installed with Above Grade Support Kit model AGS2 to maintain structural integrity

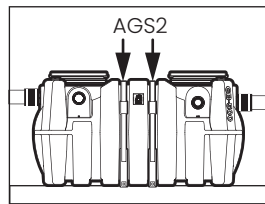

Fully Support Base of Unit

Install unit on solid, level surface in contact with the entire footprint of unit base; for suspended installations design trapeze to support the wet weight of the unit. Do not partially support unit or suspend unit using metal U-channel to create a trapeze.

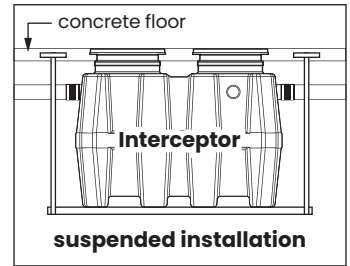

Support Inlet and Outlet Piping

For above grade installations ensure heavy inlet and outlet piping (such as cast iron or long runs) is properly supported or suspended during the entire installation process to prevent connection failure or damage to bulkhead fittings.

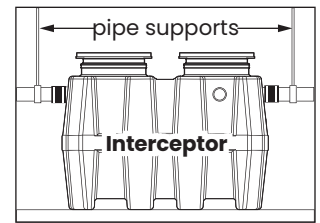

DO NOT COMPACT BACKFILL

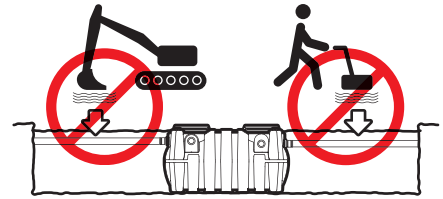

INSTALLATION

1 Leak/Seal Testing

Cap/plug all base unit plumbing connections and remove covers. **For base unit testing** fill with water to just above the highest connection. **For riser system testing** (if required) fill with water to finished grade level. **CAUTION: Risers must be supported before filling with water to prevent tipping.** Inspect unit, connections and all gaskets and clamps (if applicable) for leaks. Check water level at specific time intervals per local code. **NOTE: All GB series tanks have been wet tested for leaks prior to shipment from the factory.**

2 Install Flow Control

Schier grease interceptors are manufactured with an internal flow control system. They do not require an external flow control system or air intake vent. Schier grease interceptors are not to be installed in any other manner except as shown. Consult local codes for separate trapping requirements, cleanout locations and additional installation instructions.

Flow control is not pre-installed on this unit. If Dimension "A" in Figure A is more than 13 feet, or when the unit is installed in a high flow/increased head pressure condition (with a flow rate above 100 GPM), install flow control.

UNITS WITH 4" CONNECTIONS

Slide flow control cartridge into top of inlet diffuser and rotate clockwise until cartridge drops onto flow control retainer pins. Continue rotating clockwise until pins are fully seated in the cartridge receiver slots.

OPTIONAL: For easy flow control removal in deep burial installations, 1-1/2" PVC SCH. 40 pipe may be used as an extension handle. Before risers have been installed, cut pipe to length and attach to top of flow control cartridge using PVC primer/cement.

UNITS WITH 6" CONNECTIONS

The flow control plate for 6" connections is installed on the exterior projection of the bulkhead fitting and must be installed prior to connecting piping and burial. Fasten plate to bulkhead fitting using supplied screws. Holes in plate must line up with pre-drilled holes in bulkhead fitting and grooved side of plate must face the unit.

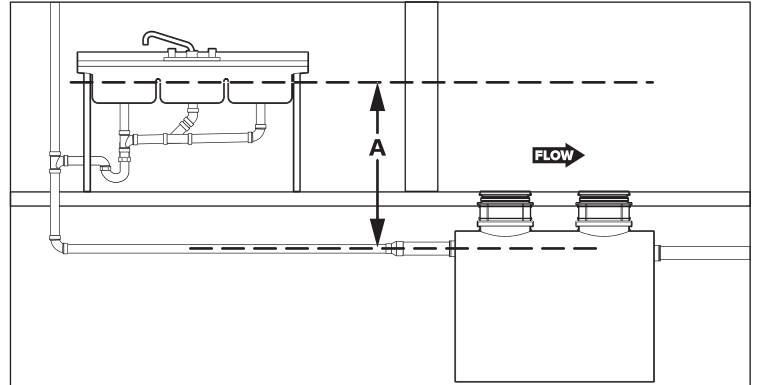
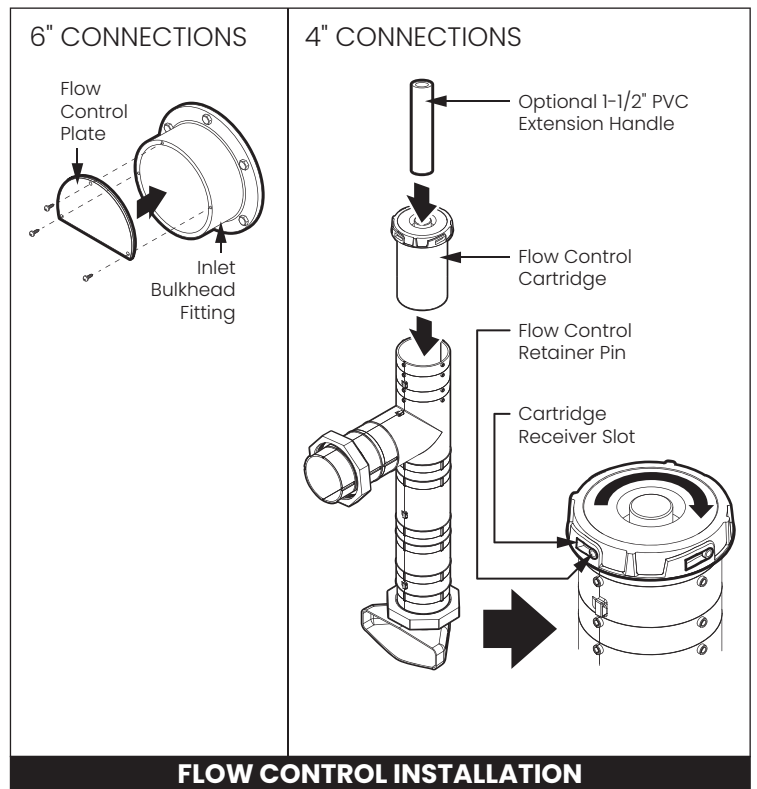

Figure A



INSTALLATION

3 Excavation

1. Install unit as close as possible to fixtures being served.
2. Surrounding soil must be undisturbed soil or well compacted engineering fill.
3. Width and length of excavation shall be a minimum of 18" greater than the tank on all sides and depth shall be 12" deeper than tank bottom.
4. Set the tank level on a 12" deep layer of well-packed crushed aggregate material.

4 Set Unit and Connect Piping

1. Lower and center the unit into hole using straps around unit. **Do not use chains or accessways to move the unit.** Ensure the unit tops are level with finished grade.
2. Mechanically couple inlet and outlet drainage lines to unit. **Do not solvent weld.** Ensure all upstream fixtures are trapped. Vent per local code. Installation of 2-way cleanout tees to grade (by others) is recommended.

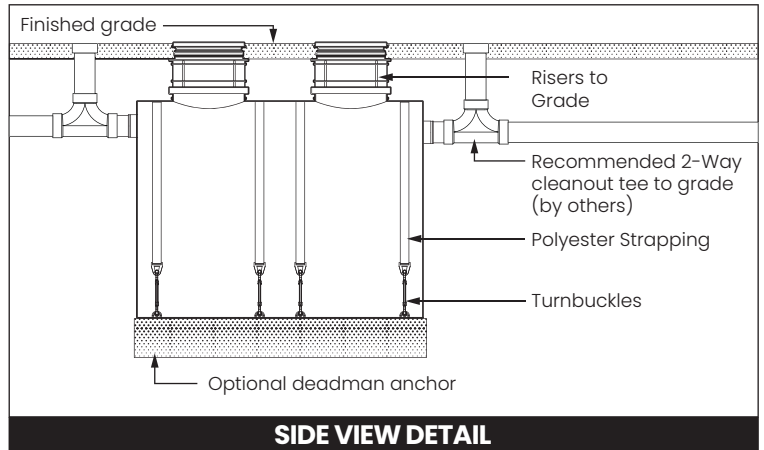
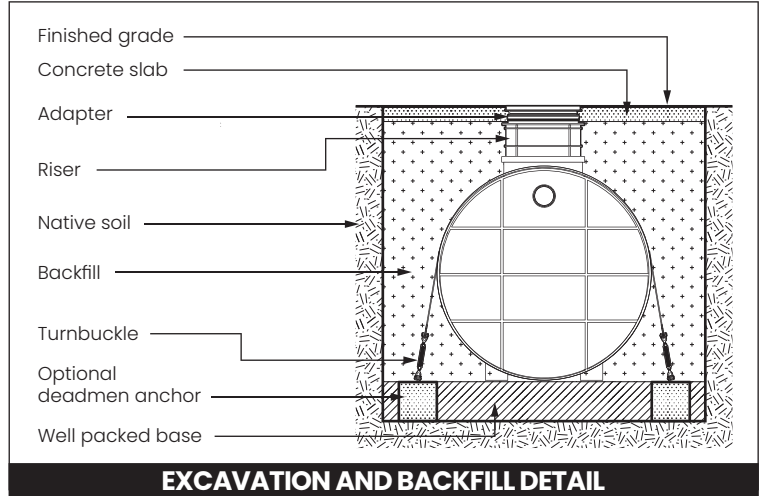

INSTALLATION

5 Bring Covers Flush-to-Grade

The GB-1000 is ready for burial depth of 77" from finished grade to bottom of tank (or 18" to centerline of inlet). Deeper burials will require extending the Cover Adapters and possibly adding risers.

5a Measure dimension X to determine riser height needed.

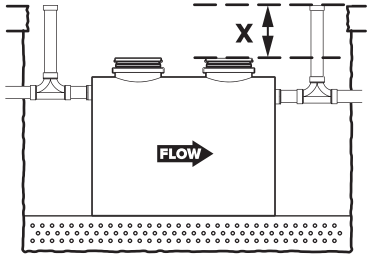

Riser Height Needed	Risers Required
0" - 4"	None (use adapter)
>4" - 34"	FCR2 (x2)
>34" - 64"	FCR2 (x4)
>64" - 94"	FCR2 (x6)

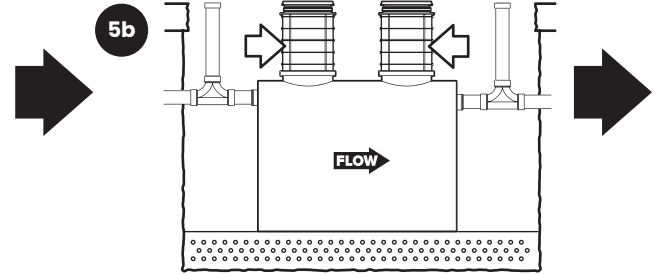

Install risers if required (see instructions included with FCR2).

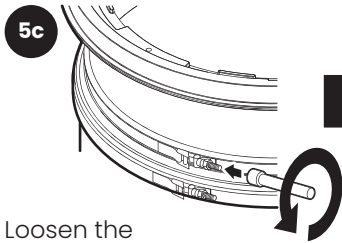

Loosen the Cover Adapter Upper Band Clamp using 7/16" Nut Driver Bit.

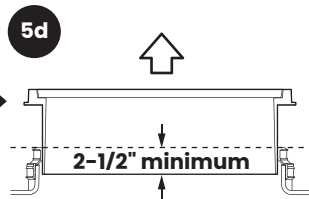

Adjust Cover Adapter heights as needed. **Maintain a minimum 2-1/2" insertion depth.**

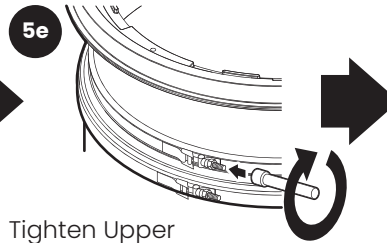

Tighten Upper Band Clamp to 5 -8 ft. lbs. of torque using 7/16" Nut Driver Bit.

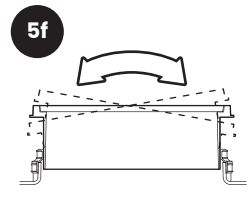

If required, Cover Adapters may now be tilted up to 10° in any direction using gasket flexibility.

6 Backfill and Finished Grade

BACKFILL

1. Preparation of sub grade per geotech recommendations.
2. Stabilize and compact sub grade to 95% proctor.
3. Fill unit with water before backfilling to stabilize unit and prevent float-out during backfilling. Secure covers and risers (if necessary) to the unit. For units with cast iron covers, remove retainer clips prior to burial.
4. Backfill evenly around tank using crushed aggregate (approximately 3/4" size rock or sand, with no fines), or flowable fill.

Do not compact backfill around unit.

FINISHED CONCRETE SLAB

Slab must extend 18" minimum outside the footprint of the unit.

Pedestrian traffic or greenspace areas: 4" Thick reinforced concrete slab required.

Vehicular traffic areas: Minimum 8" Thick concrete slab with rebar required. Thickness of concrete around cover to be determined by specifying engineer. If traffic loading is required the concrete slab dimensions shown are for guideline purposes only. Concrete to be 28 day compressive strength to 4,000 PSI. Use NO. 4 rebar ($\phi 1/2"$) grade 60 steel per ASTM A615; connected with tie wire. Rebar to be 2-1/2" from edge of concrete and spaced in a 12" grid with 4" spacing around access openings.

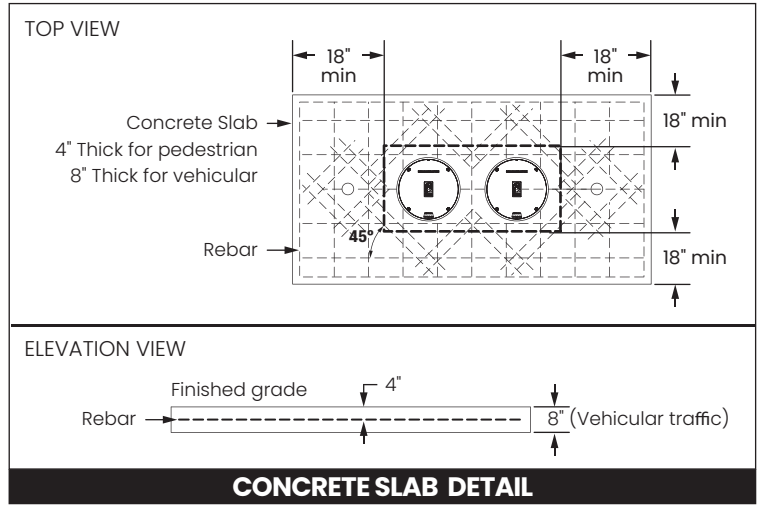

INSTALLATION OPTIONS

1 High Water Table Installations, See Anchor Kit Model AK3

Deadmen Anchoring:

If the installation location is in a high water table area or at risk are (including but not limited to tidal surge areas, floodplains and areas that receive storm water) the GB-1000 must be secured to concrete deadmen anchors (by others) using Schier model AK3 anchor kit.

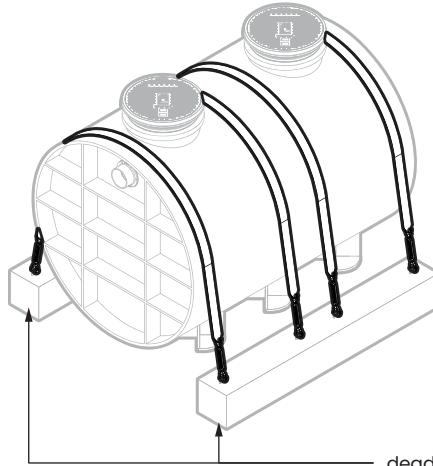

2 Series Installations

For lower flow rates and higher grease storage requirements. Piping between units and two-way cleanout tees by others.

All units must be level in the excavation pit. Note that downstream units must be buried 2" deeper than the adjacent, upstream fixture. Two-way cleanout tees extended to finished grade should be installed before the first unit inlet, after the last unit outlet and in between units (if there is a long run of pipe between units) for line cleaning purposes.

NOTE: When the flow control is required, it should only be installed on the first unit in the series.

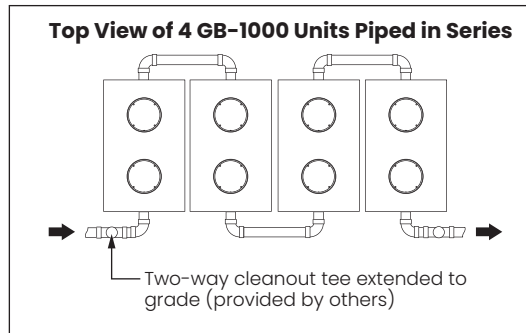

Rated Grease Capacities for Units Piped in Series

No. of Units in Series	Removal Efficiency	
	100 GPM	95.3%
2	13,094 lbs.	12,474 lbs.
3	19,641 lbs.	18,711 lbs.
4	26,188 lbs.	24,948 lbs.



Units piped in series are certified to ASME A112.14.3 (Type C) and CSA B481.1 and include an internal flow control. External flow control with vent not required.

* Satisfies Miami DERM 99% efficiency requirements

