

Approvals & Certifications

- ASME B16.51
- IAPMO PS-117
- NSF/ANSI 61
- NSF/ANSI 372
- CSA

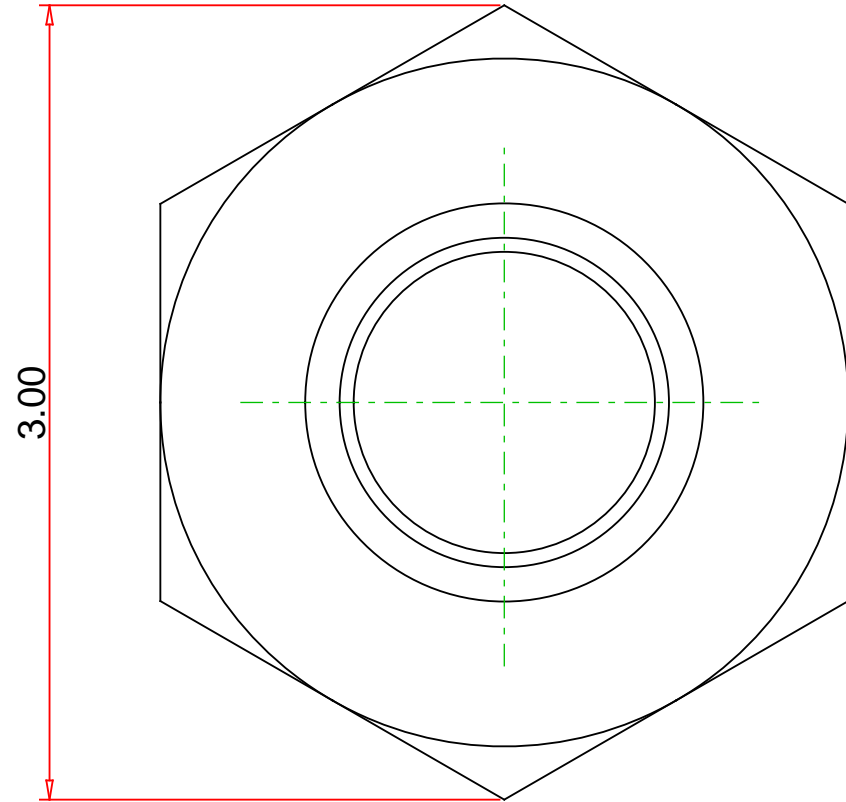
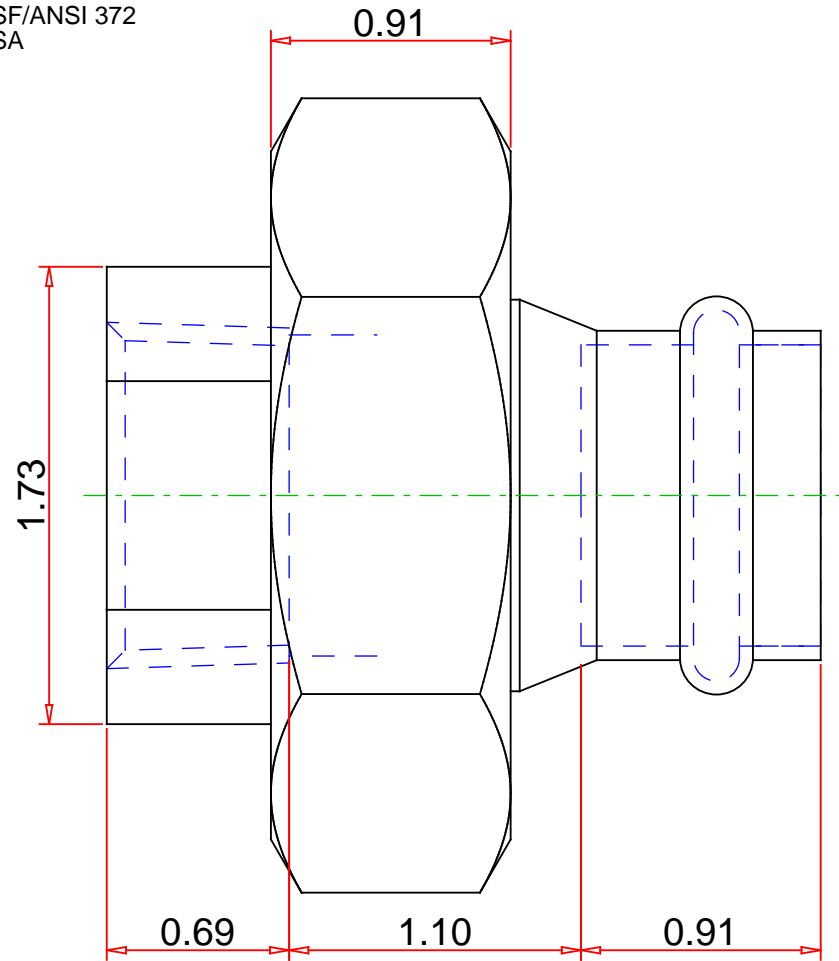

Note : - Drawing not to Scale

DISCLAIMER: DIMENSIONS ARE APPROXIMATE AND ARE SUBJECT TO CHANGE WITHOUT NOTICE. ALL ASME DIMS ARE MINIMUM UNLESS NOTED. LAY LENGTH DIMS ARE ± 0.06 ALL OTHER DIMS ARE NOMINAL. ALL DIMS ARE IN INCHES.

© 6-AUG-2021 Mueller Industries, Inc.

Part No. :

PF 11505

Description :

Dielectric Union, P x FPT , 1" x 1"



Mueller Streamline Co.

Address: 150 Schilling Blvd, Suite 201

Collierville, TN 38017

Phone: 901-751-7709

Email: marketing@muellerstreamline.com

Web: <https://www.muellerstreamline.com>