

SPARES

U.PRF1
REPLACEMENT
NANO FILTER

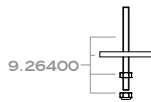
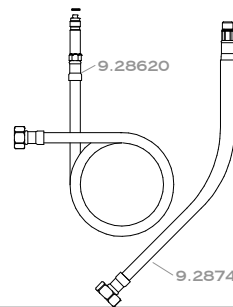
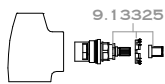
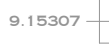
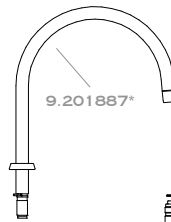
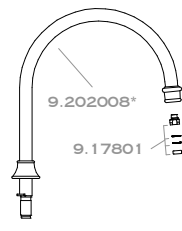
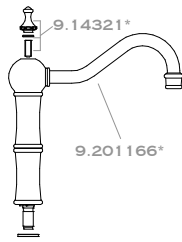

* WHERE INDICATED PLEASE SPECIFY COLOR

INSTALLATION INSTRUCTIONS

• INSTANT HOT TAP •



• CARTRIDGE REPLACEMENT

THE FILTER CARTRIDGE IN YOUR INSTANT HOT TAP SYSTEM NEEDS TO BE CHANGED EVERY SIX MONTHS IN ORDER TO ENSURE THE SYSTEM WORKS AT ITS OPTIMUM PERFORMANCE.

CHANGING THE FILTER CARTRIDGE IS A SIMPLE MATTER:

1. SWITCH OFF THE HEATER TANK EITHER AT THE MAINS OR BY PRESSING THE CENTRE BUTTON ON THE HEATER TANK TOUCH SCREEN.
*****IMPORTANT NOTICE*** – RUN OFF ALL HOT WATER UNTIL JUST COLD WATER IS COMING OUT OF THE TAP.**
2. PLACE A SMALL BOWL UNDER THE FILTER HOUSING SUMP TO CATCH THE SMALL AMOUNT OF WATER THAT WILL BE RELEASED WHEN REMOVING THE FILTER HOUSING SUMP.
3. TURN THE FILTER HOUSING SUMP ANTI-CLOCKWISE A QUARTER TURN, TO ALLOW THE FILTER HOUSING SUMP TO DROP DOWN FROM THE FILTER HOUSING HEAD.
4. ONCE THE SUMP IS REMOVED, UNSCREW THE FILTER HOUSING CAP FROM THE SUMP AND TIP ANY WATER OUT OF THE SUMP INTO THE BOWL OR SINK.
5. REMOVE THE OLD FILTER BY PULLING THE FILTER FROM THE CAP.
6. DISPOSE OF THE OLD FILTER IN THE NORMAL HOUSEHOLD WASTE BIN.
REMEMBERING TO KEEP THE FILTER INSERT AS YOU WILL NEED THIS FOR THE REPLACEMENT FILTER.
7. FIT THE NEW FILTER BY PUSHING THE FILTER INSERT INTO THE TOP OF THE FILTER THEN INTO THE CAP; YOU MAY NEED TO WET THE 'O' SEALS IN THE TOP OF THE FILTER AS SHOWN IN THE ATTACHED DRAWING REFERENCED A. ALWAYS INSPECT THE 'O' SEALS FOR DAMAGE; FOR REPLACEMENTS USE CONTACT DETAILS BELOW.
8. SCREW THE SUMP BACK ONTO THE CAP (ENSURING THAT THE 'O' SEAL IS IN PLACE), REFERENCED B.
9. PUSH THE FILTER HOUSING SUMP BACK INTO THE FILTER HOUSING HEAD AND TURN CLOCKWISE UNTIL IT STOPS.

IMPORTANT NOTICE

THE FILTER IS NOW READY TO USE – IT IS VITALLY IMPORTANT THAT YOU FOLLOW THE PROCESS BELOW TO ENSURE THAT ALL AIR IS BLED FROM THE SYSTEM. **PLACE A JUG UNDER THE SPOUT AS WATER WILL SPLUTTER FROM THE SPOUT UNTIL ALL OF THE AIR IS EXPELLED.**

OPERATE THE INSTANT HOT TAP LEVER TO DISPENSE WATER, RUN-OFF AT LEAST 0.35 GALLONS OF WATER, LET THE SYSTEM REST FOR AT LEAST 30 SECONDS AND RUN ANOTHER 0.35 GALLONS OF WATER, REPEAT THIS AT LEAST ONE MORE TIME – YOUR INSTANT HOT WATER TAP SHOULD NOW BE READY FOR USE.

YOU MUST NOW THOROUGHLY CHECK THE UNIT FOR ANY WATER LEAKS AND TAKE THIS OPPORTUNITY TO CHECK FOR ANY EXCESS WEAR OR DAMAGE TO THE SYSTEM. IF THERE ARE NO LEAKS PLEASE CONTINUE:

10. NOW SWITCH THE HEATER TANK BACK ON AT THE MAINS, OR BY PRESSING THE BUTTON IN THE CENTRE OF THE HEATER TANK TOUCH SCREEN.
11. SET THE DESIRED TEMPERATURE BY PRESSING THE RIGHT HAND BUTTON UNTIL THE DESIRED TEMPERATURE IS DISPLAYED (USUALLY 98 DEGREES)
12. PRESS THE LEFT HAND BUTTON TO CONFIRM THE TEMPERATURE SETTING.
13. THE HEATER TANK WILL NOW HEAT UP TO THE DESIRED TEMPERATURE AND ONCE COMPLETED THE SYSTEM IS READY FOR USE.

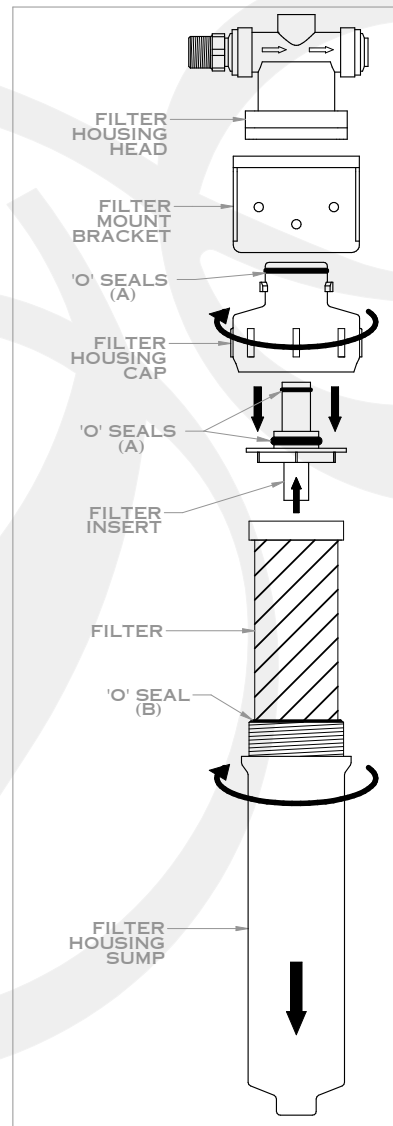

ROHL[®]
Authentic Luxury for Kitchen and Bath™

SHOULD YOU REQUIRE ANY ADVICE, OR A QUICK SOLUTION TO A PROBLEM WITH THIS PRODUCT PLEASE CONTACT IN THE FIRST INSTANCE THE SUPPLIER/SHOWROOM FROM WHICH IT WAS PURCHASED.

• T: 1-800-777-9762 • E: ROHLINFO@ROHLHOME.COM • W: WWW.ROHLHOME.COM