



Lustra™ Q2™ Advantage™

Toilet Seat
K-4652

Features

- Solid polypropylene plastic.
- Elongated closed-front seat.
- Contoured seat for user comfort.
- Quick-Release™ hinge caps snap open and seat pulls forward for removal.
- Quick-Attach™ stainless steel fastener allows for top-mount screwdriver only install.



Codes/Standards



















IAPMO/ANSI Z124.5

KOHLER® One-Year Limited Warranty

See website for detailed warranty information.

Available Color/Finishes

Color tiles intended for reference only.

Color	Code	Description
	0	White
	W2	Earthen White
	96	Biscuit
	47	Almond
	NY	Dune
	55	Innocent Blush™
	Y2	Sunlight
	NG	Tea Green
	95	Ice™ Grey
	G9	Sandbar
	33	Mexican Sand™
	6	Skylight
	45	Wild Rose™
	K4	Cashmere
	58	Thunder™ Grey
	52	Navy
	7	Black Black™
	12	Jersey Cream
	17	Teal

USA/Canada: 1-800-4KOHLER (1-800-456-4537)

Kohler Co. reserves the right to make revisions without notice to product specifications.

For the most current Specification Sheet, go to www.kohler.com.

12-20-2016 05:51

THE BOLD LOOK
OF **KOHLER**®

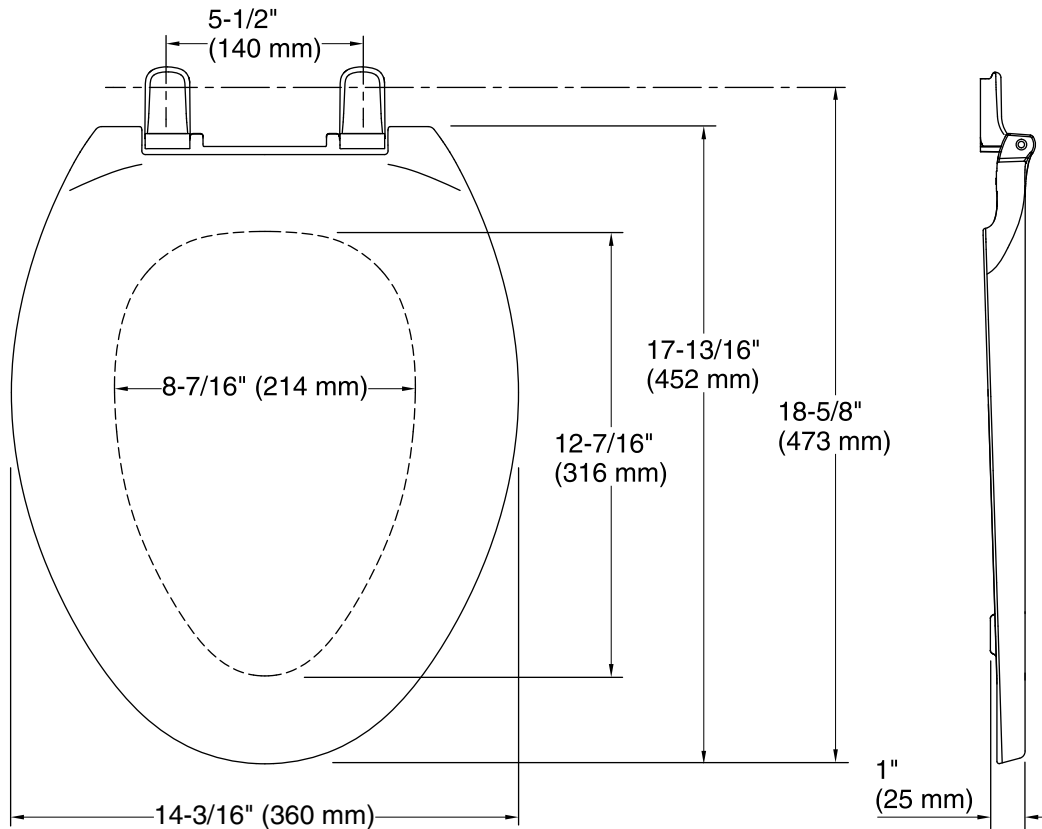

Technical Information

All product dimensions are nominal.

- Seat shape type: Elongated
Seat front type: Closed front
Seat hinge type: Quick-Attach®, Quick-Release™
Seat-mounting holes: 5-1/2" (140 mm)

Notes

Install this product according to the installation guide.