

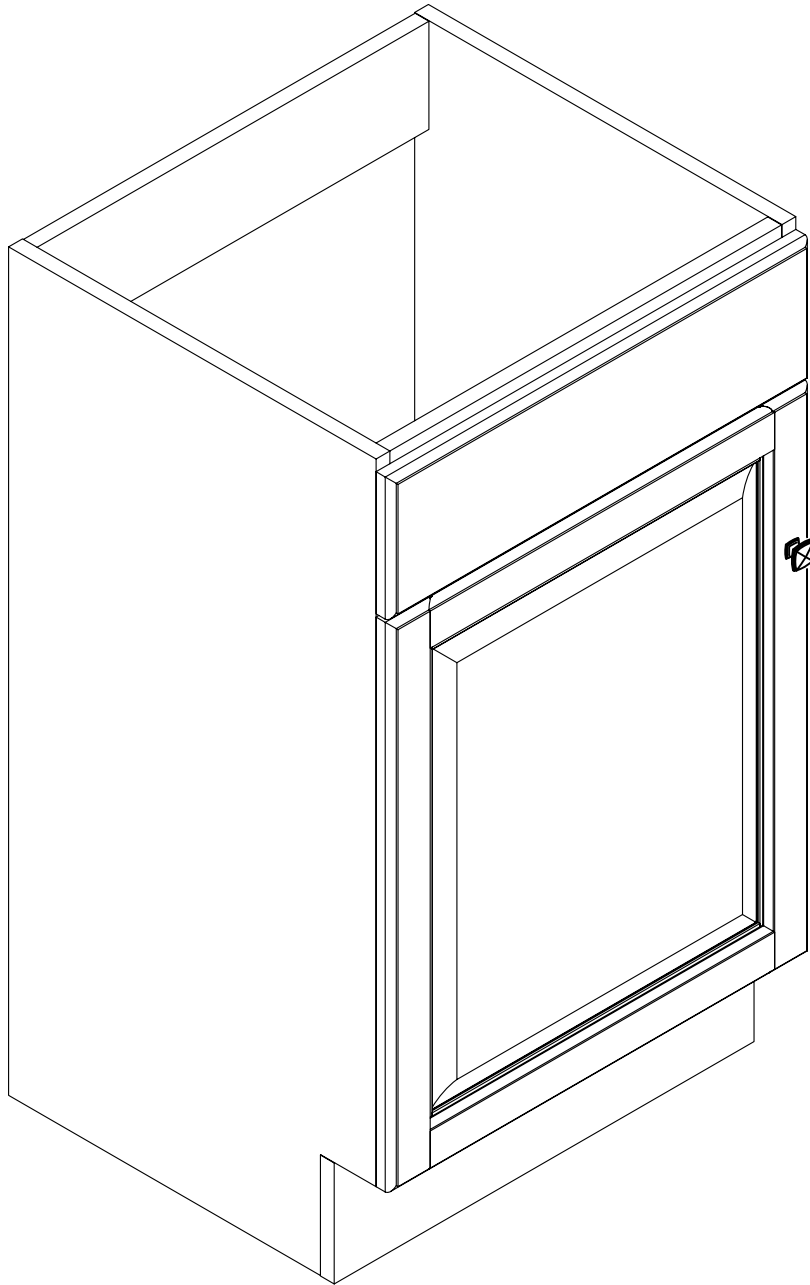

www.todaysdesignhouse.com



531723

ASSEMBLY INSTRUCTIONS

DHI Corp. • 5205 W. Donges Bay Rd. • Mequon, WI 53092 • 800.558.8700

PARTS LIST:

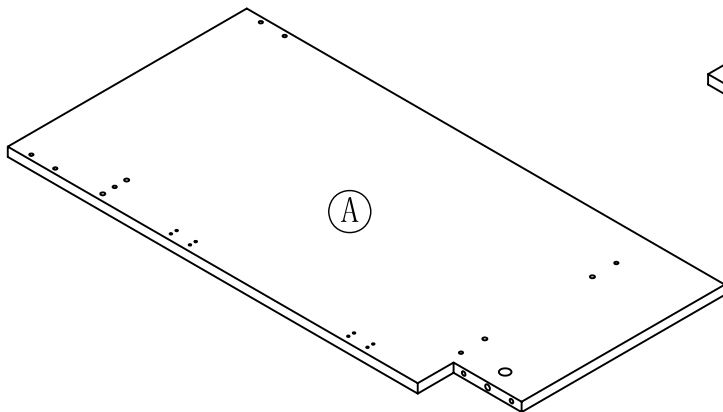

LEFT SIDE PANEL 1PC

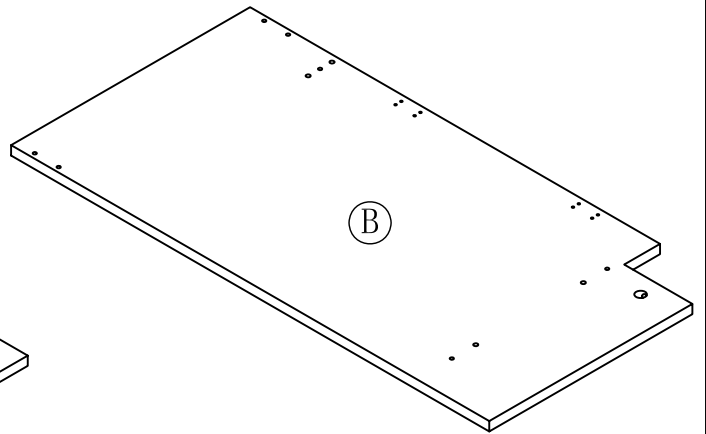

RIGHT SIDE PANEL 1PC

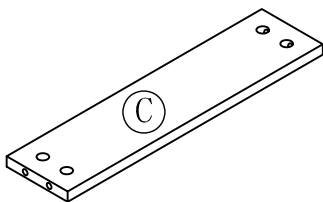

BACK CROSS BRACE 1PC

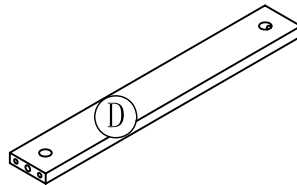

FRONT CROSS BRACE 1PC

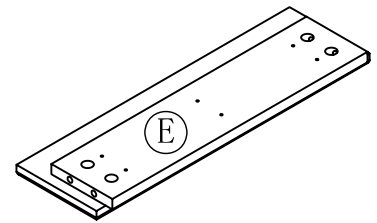

FALSE DRAWER FRONT 1PC

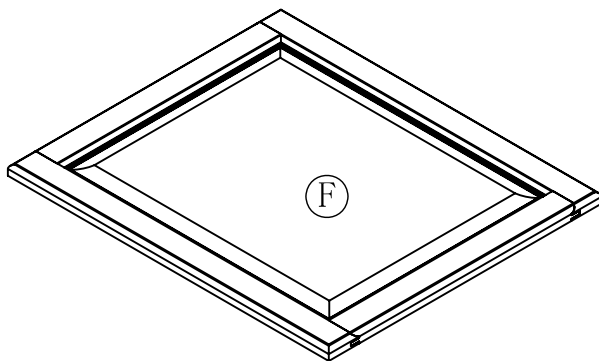

DOOR 1PC

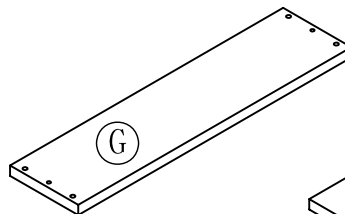

TOE KICK PANEL 1PC

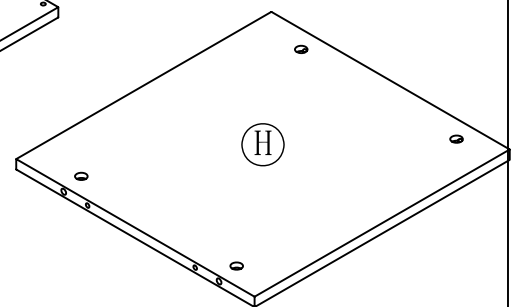

BOTTOM PANEL 1PC

HARDWARE LIST:



a. WOOD DOWEL 12PCS

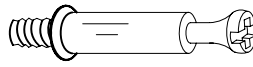

b. CAM LOCK SCREW 16PCS

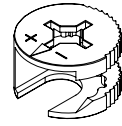

c. CAM LOCK 16PCS

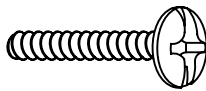

d. KNOB BOLT 1PC

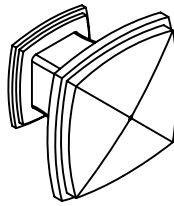

e. KNOB 1PC

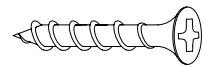

f. 5/8" L FLAT HEAD SCREW 12PCS

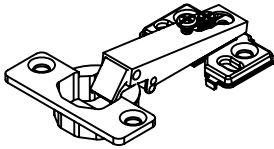

g. HINGE 2PCS



h. WRENCH 1PC

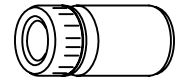

i. GLUE 1PC

STEP 1

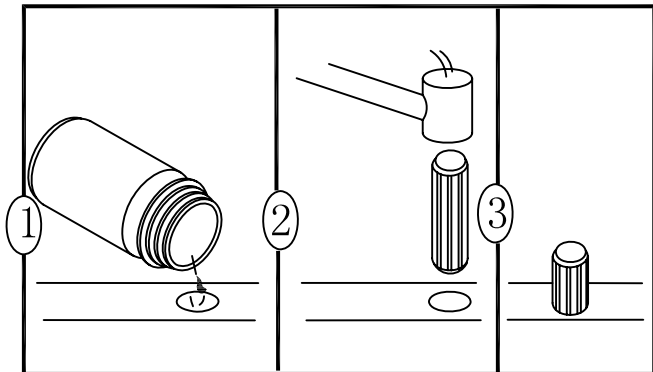
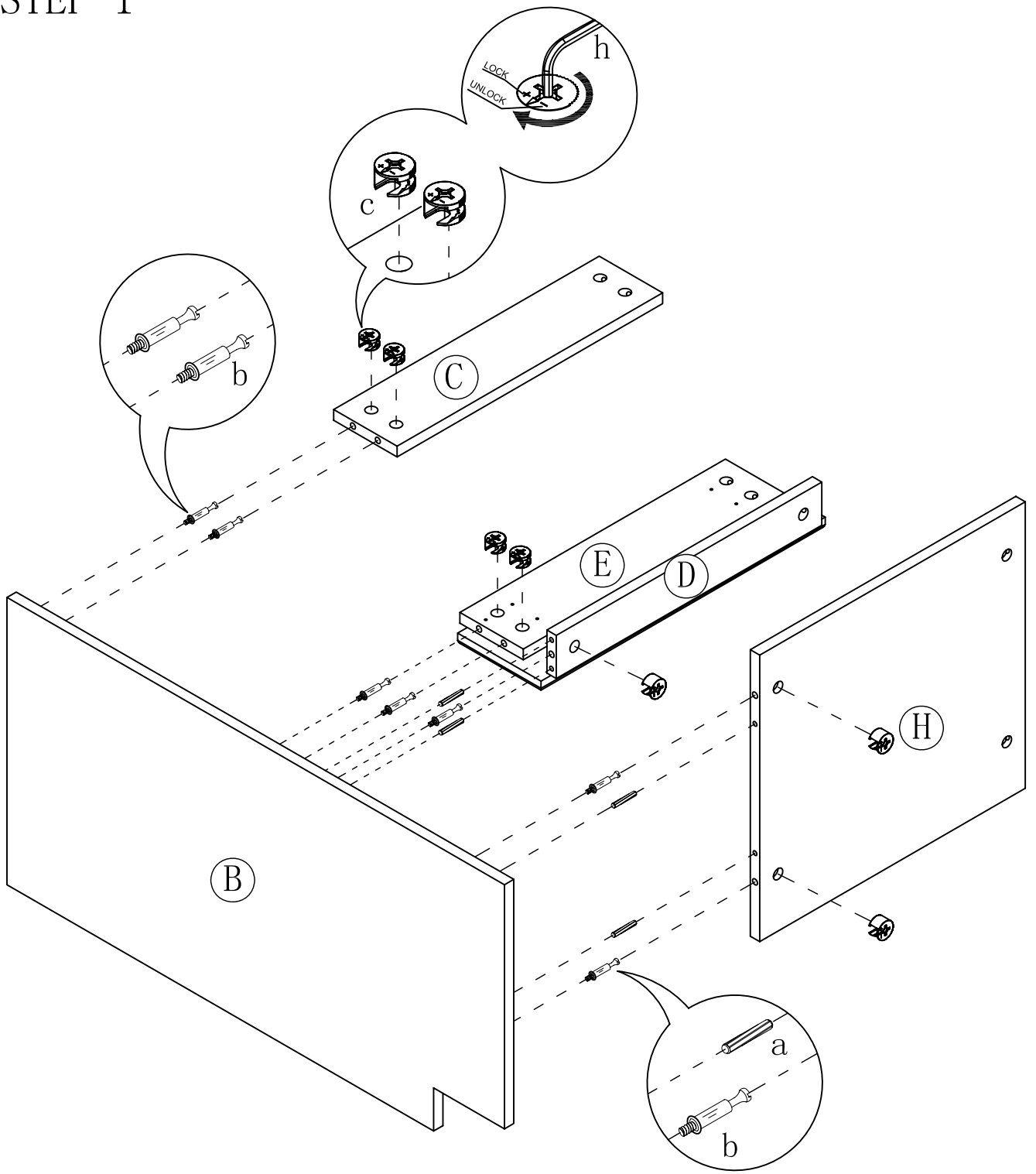

STEP 2

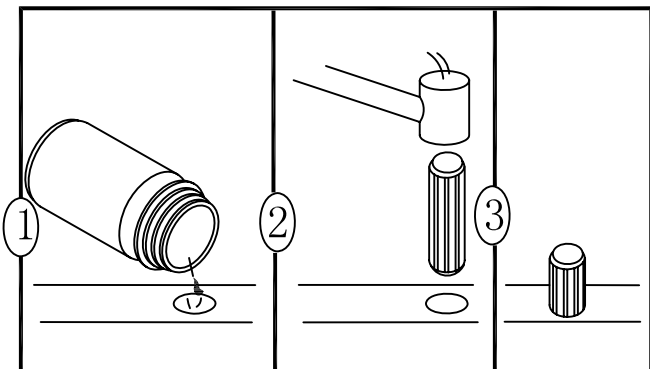
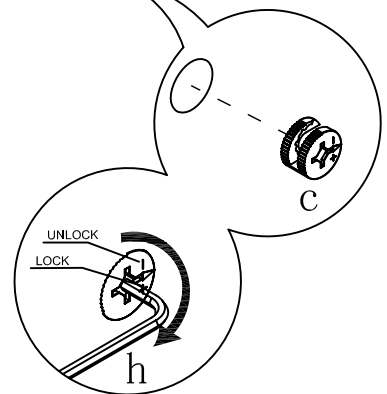
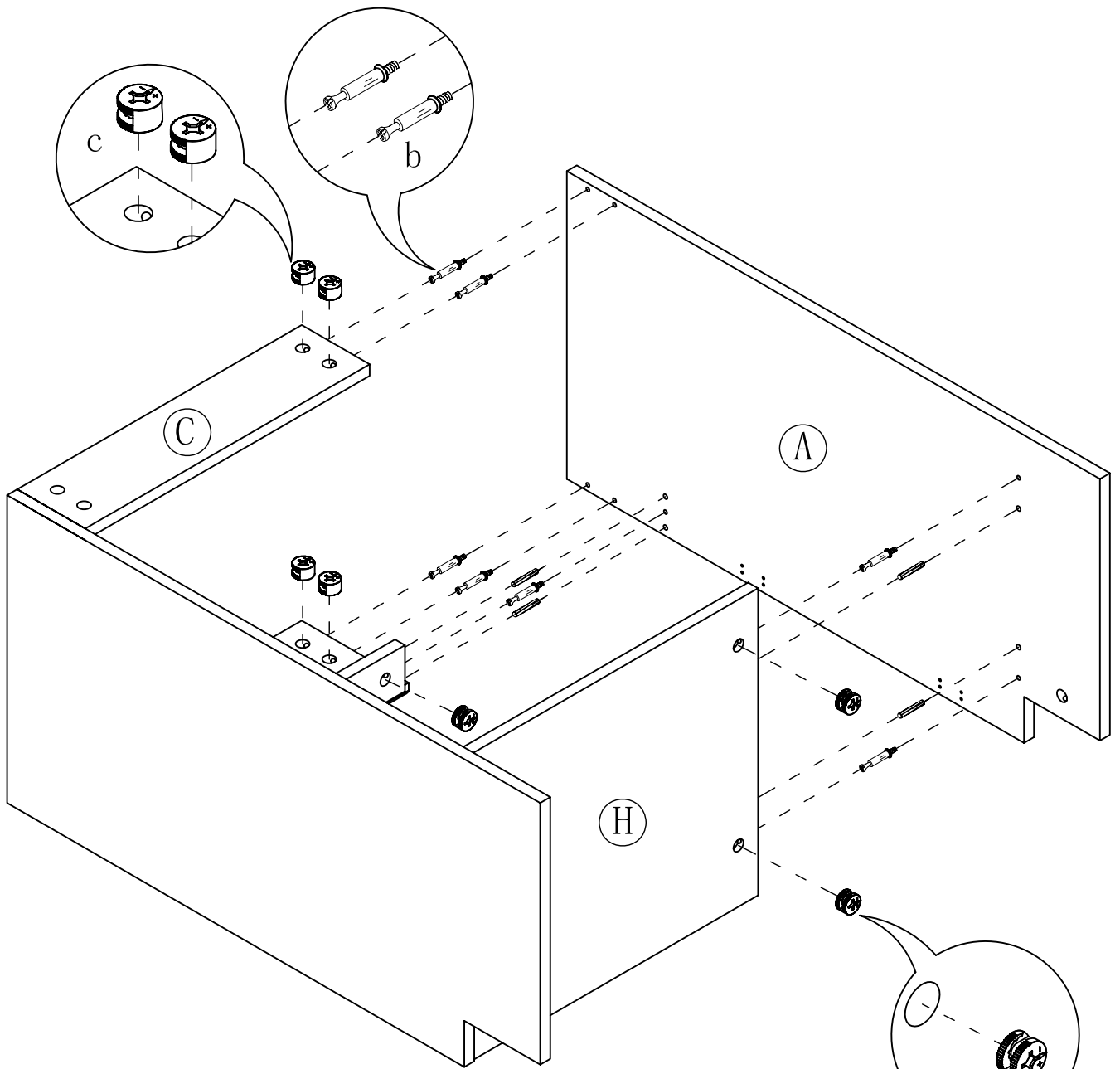

STEP 3

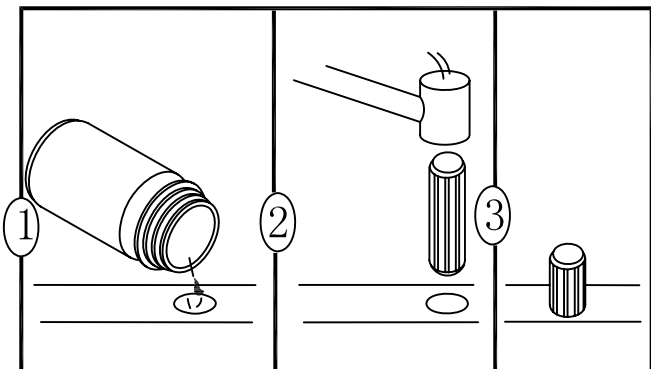
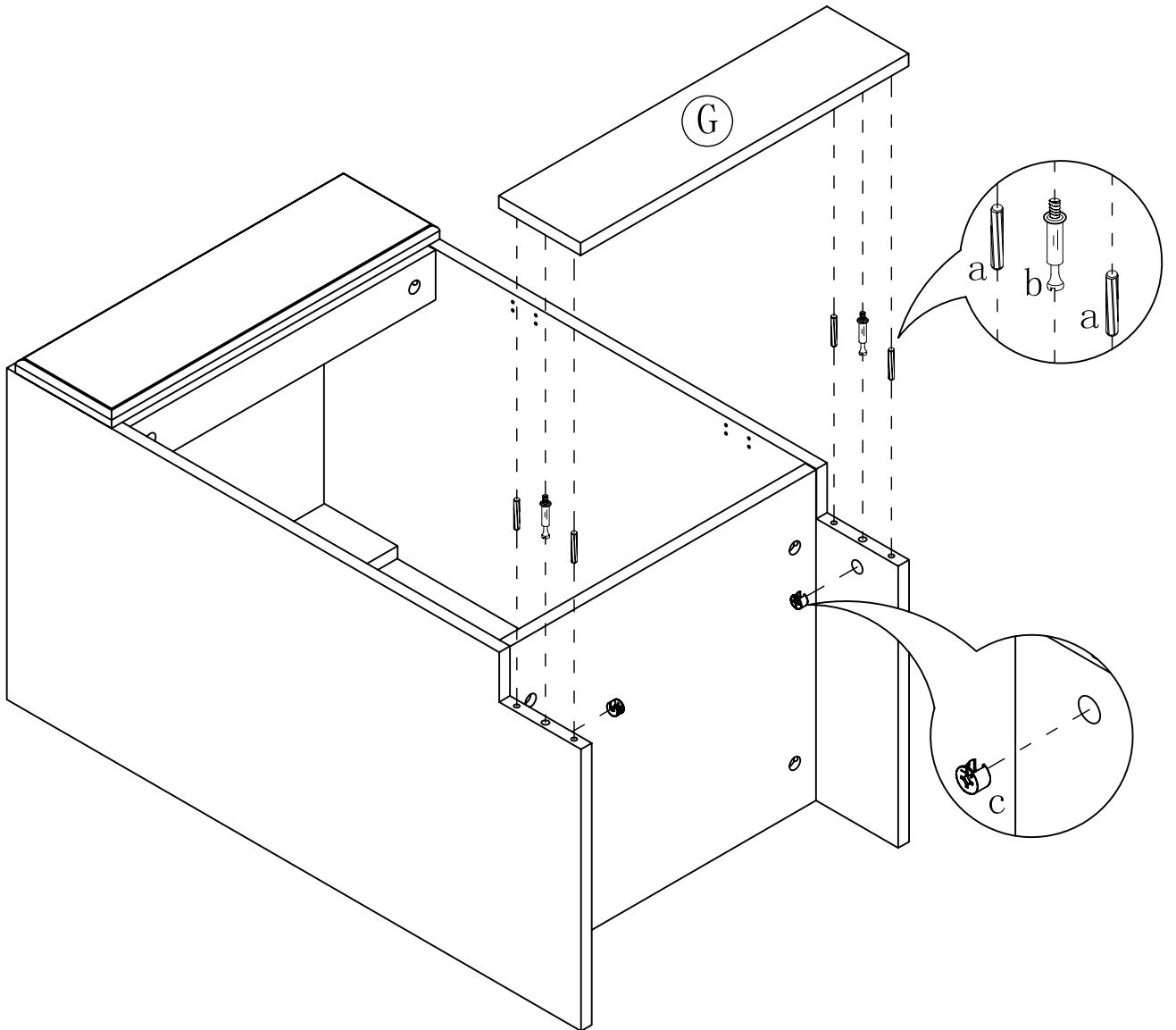

STEP 4

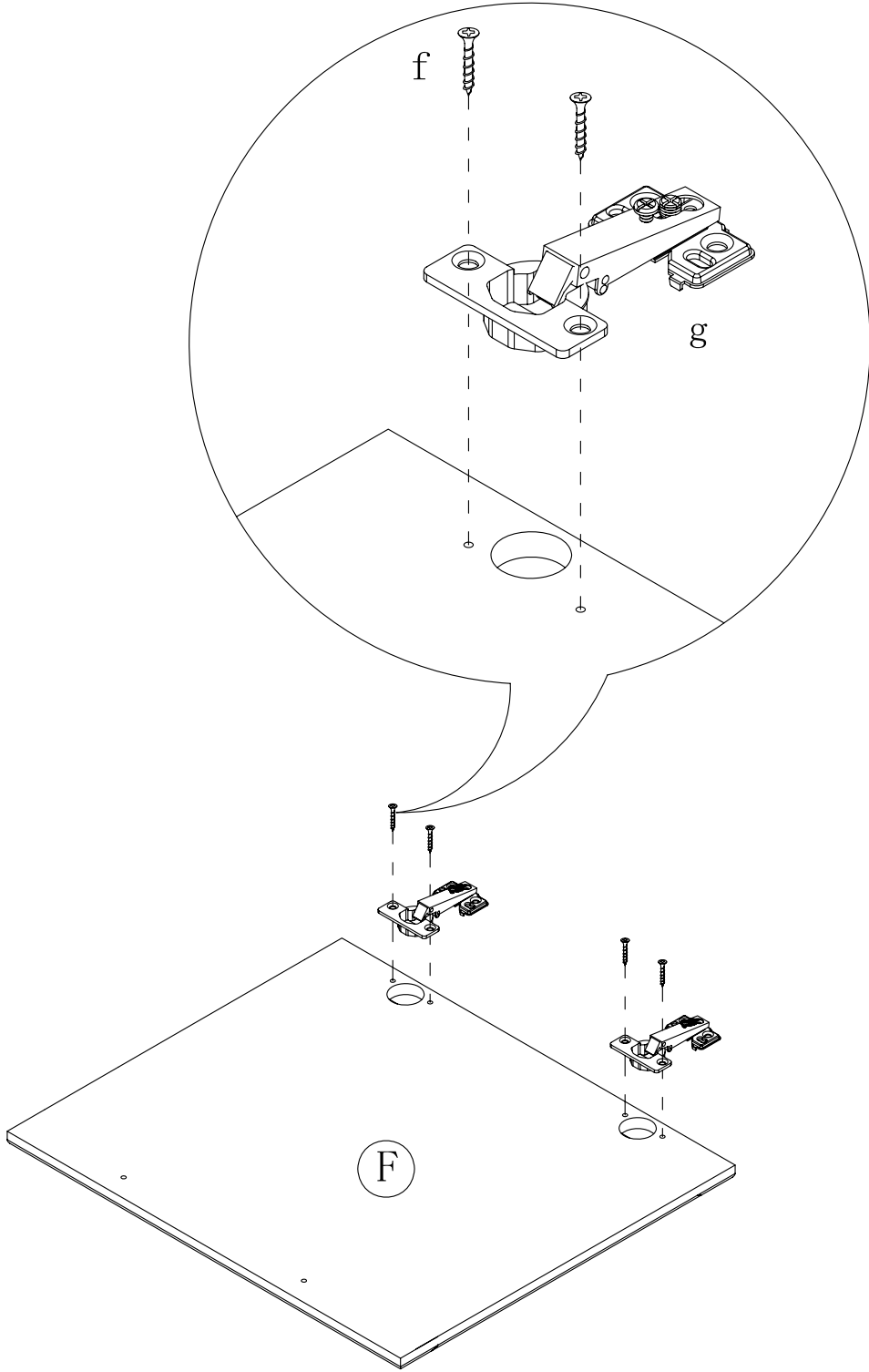

STEP 5

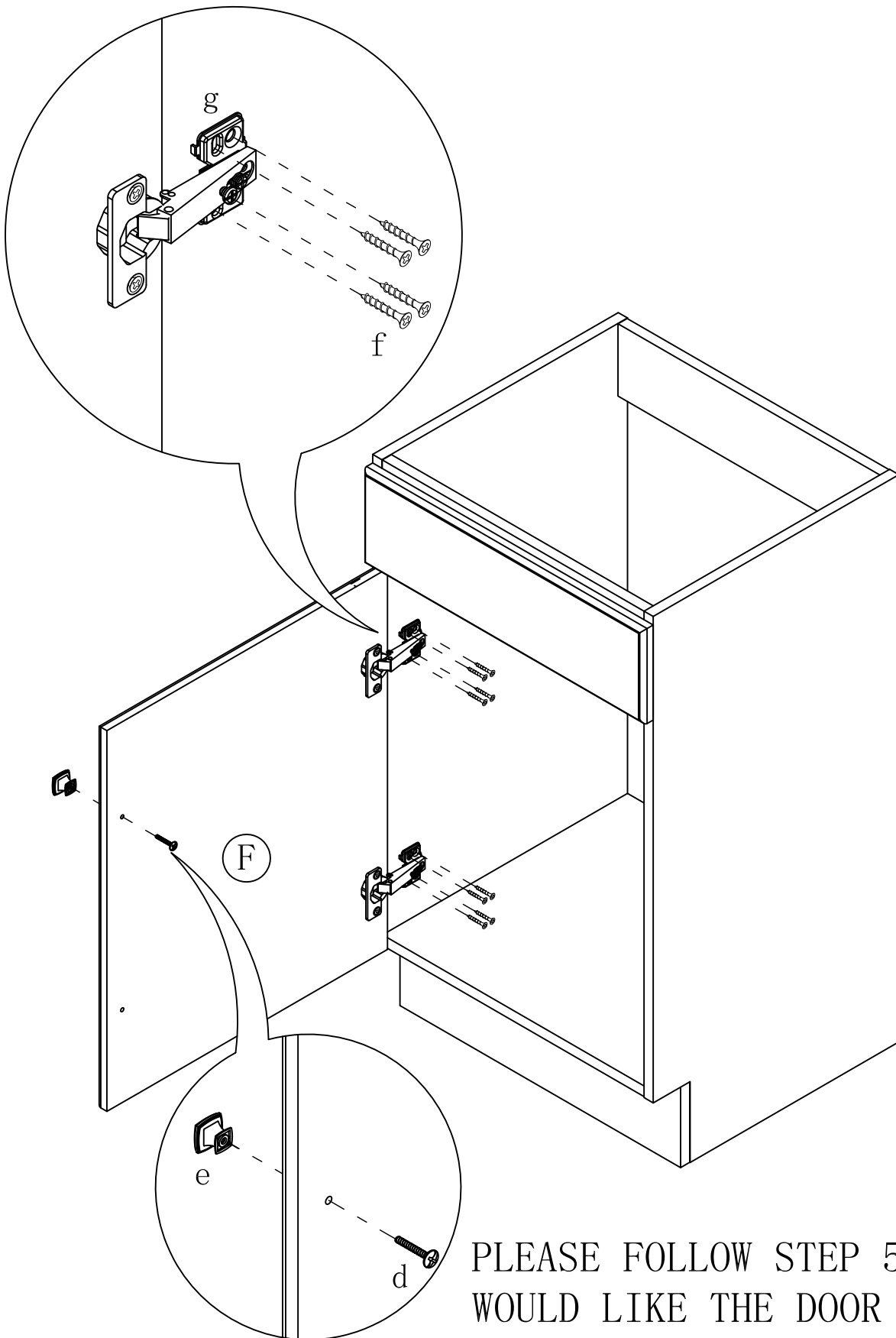

PLEASE FOLLOW STEP 5 IF YOU
WOULD LIKE THE DOOR OPEN
FROM THE LEFT

STEP 6

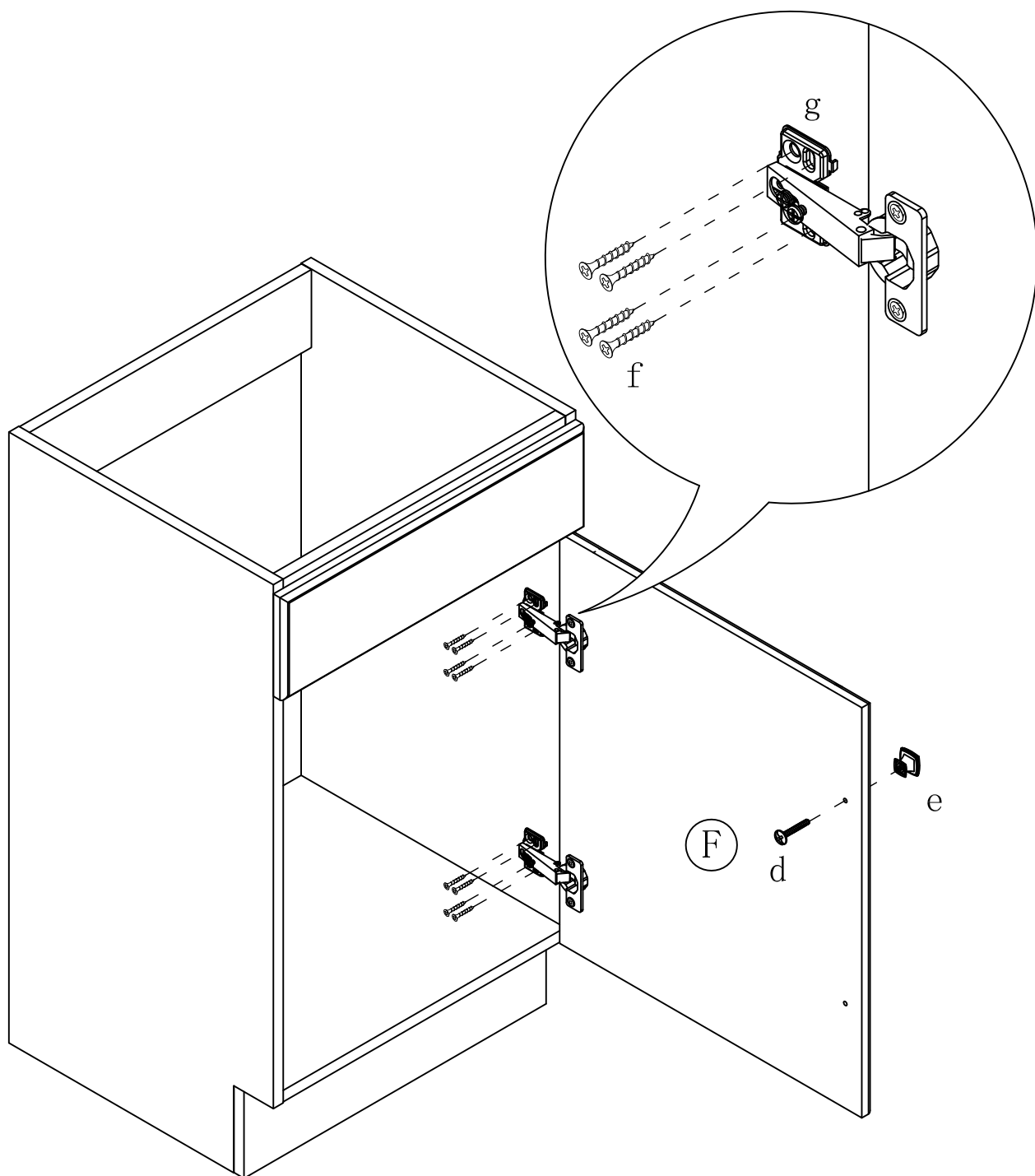

PLEASE FOLLOW STEP 6 IF YOU
WOULD LIKE THE DOOR OPEN
FROM THE RIGHT