

# DAIKIN ONE+ TRANSLATION ADAPTOR INSTALLATION INSTRUCTIONS

© 2020 **DAIKIN MANUFACTURING COMPANY, L.P**  
19001 Kermier Rd. Waller, TX 77484  
[www.daikincomfort.com](http://www.daikincomfort.com)  
P/N: IOD-7134B Date: October 2020

## WARNING

Only personnel that have been trained to install, adjust, service or repair (hereinafter, "service") the equipment specified in this manual should service the equipment. The manufacturer will not be responsible for any injury or property damage arising from improper service or service procedures. If you service this unit, you assume responsibility for any injury or property damage which may result. In addition, in jurisdictions that require one or more licenses to service the equipment specified in this manual, only licensed personnel should service the equipment. Improper installation, adjustment, servicing or repair of the equipment specified in this manual, or attempting to install, adjust, service or repair the equipment specified in this manual without proper training may result in product damage, property damage, personal injury or death.

## PROP 65 WARNING FOR CALIFORNIA CONSUMERS

## WARNING

Cancer and Reproductive Harm -  
[www.P65Warnings.ca.gov](http://www.P65Warnings.ca.gov)

0140M00517-A

## WARNING









**HIGH VOLTAGE**  
DISCONNECT ALL POWER BEFORE SERVICING  
OR INSTALLING THIS UNIT. MULTIPLE POWER  
SOURCES MAY BE PRESENT. FAILURE TO DO SO  
MAY CAUSE PROPERTY DAMAGE, PERSONAL  
INJURY OR DEATH.

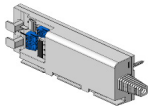

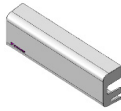
### Safety Precautions

1. Only qualified personnel can carry out the equipment installation.
2. Make sure to turn off the power supply before starting the wiring work and do not turn on until the work is completed. Read the installation manual and wiring diagram of the indoor unit when carry out the work.
3. Make sure to securely connect the connectors, unsecured connections may result in improper communication and/or malfunction.
4. Do not splice wires.

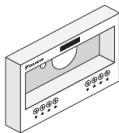
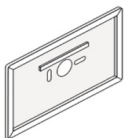
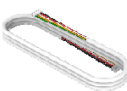
### Items in the packaging

<b>Item</b>	Translation Adaptor with power supply wire	P1P2 connector (removable)	Thermostat connector (removable)	Front cover	Adaptor mounting plate	Screws	Adhesive tape
<b>Qty.</b>	1	1	1	1	1	4	1
<b>Image</b>							
<b>Item</b>	Daikin One+ Thermostat	Thermostat terminal plate	Thermostat mounting plate	S21 wiring cable	Welcome documents		
<b>Qty.</b>	1	1	1	1	1		
<b>Image</b>							



## Product Overview

The Daikin One+ Translation Adaptor is used to connect the Daikin One+ thermostat with Daikin VRV, SkyAir, Single-Zone and Multi-zone systems.

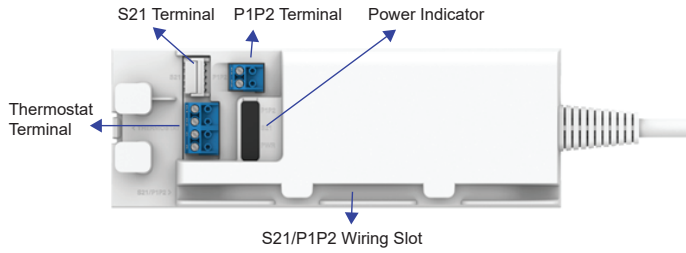

The Daikin One+ Smart Thermostat cannot be used with other wireless or wired remote controllers. For retrofit projects, please remove any other remote controller(s) before installation.



## Dimension Drawings

### 1. Translation Adaptor

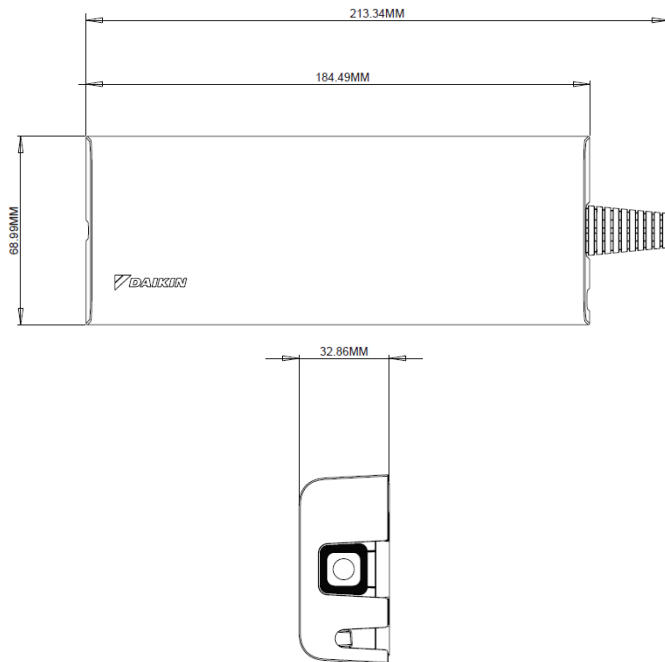

### 2. Mounting Plate

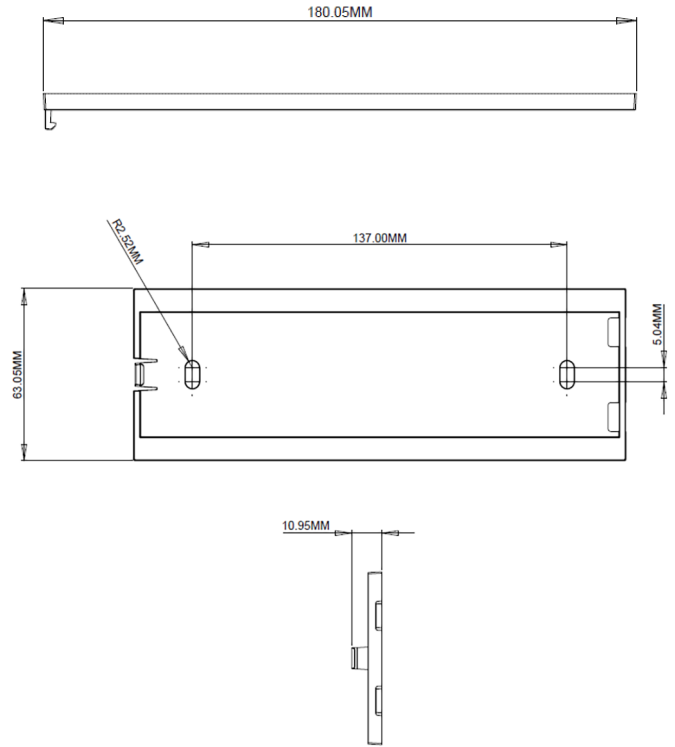

## Specification

<b>Model</b>	DTST-ONE-ADA-A	
<b>Description</b>	Daikin One+ Smart Thermostat for VRV and Ductless Products	
<b>Maximum Connections</b>	1 S21 Indoor Unit (cannot use together with another wireless remote controller or wired remote controller)	
	16 P1P2 Indoor Units (1 remote controller group) (cannot use together with another wireless remote controller or wired remote controller)	
<b>Max Wiring Length</b>	<b>Power Wire</b>	5.5 ft (included)
	<b>Thermostat Wire</b>	125 ft (Field-supplied, 18AWG, 4-conductor non-shielded wire)
	<b>S21 Communication Wire</b>	5.5 ft (included)
<b>Power Supply</b>	<b>P1P2 Communication Wire</b>	6 ft* (Field-supplied, 18AWG, 2-conductor non-shielded <b>stranded</b> wire) <b>Do not</b> use solid wire
	<b>Thermostat</b>	Obtained from the Translation Adaptor
<b>Dimensions</b>	<b>Translation Adaptor</b>	110-240 VAC
	<b>Thermostat</b>	6.8" x 3.4" x 0.8"
<b>Weight</b>	<b>Thermostat Adaptor</b>	2.72" x 7.26" x 0.43"
	<b>Thermostat</b>	10.5 oz
<b>Storage Temperature</b>	32°F to 120°F	
<b>Operation Temperature</b>	32°F to 120°F	
<b>Humidity</b>	20 to 95% RH (non-condensing)	

\*P1P2 wire has a maximum wiring length of 1640 feet

## Selection of Mounting Location

The recommended mounting location and approach vary for different Daikin indoor unit types.

### 1. Wall-mounted unit

Applicable models: CTXS, FAQ, FTK\_N, FTX\_N, FTX\_U, FTXG, FTXR, FTXS, FXAQ

For wall-mounted units, if the refrigerant piping is installed on the right side and the refrigerant piping chase inside the indoor unit is not occupied, it is recommended to mount the Translation Adaptor inside the indoor unit so that the Adaptor is concealed. Otherwise, the Adaptor will need to be mounted outside of the indoor unit.

- Mounting inside the indoor unit piping chase.
  - Make use of the extra space left by the indoor unit mounting plate, mount the backplate of the Adaptor to the wall. The extra space varies for different indoor unit models, use the largest available space for mounting. Make sure the high voltage power side of the Adaptor is facing towards the indoor unit electrical box. When installed inside the piping chase, the front cover is optional. For some of the wall mount units, removal of the front plate may be required to fit inside the piping chase.
  - If the Adaptor is mounted inside the unit, there is no need to install the Adaptor cover.

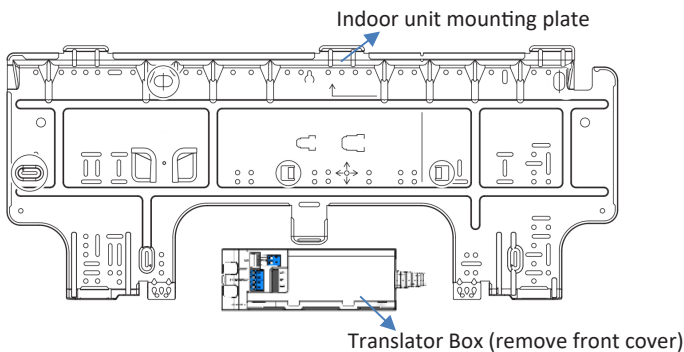

- Mounting outside of the indoor unit
  - If the refrigerant piping is left-side installed and the piping chase is occupied by the refrigerant piping, the Translation Adaptor needs to be mounted outside the indoor unit. Select a location that will provide access to the indoor unit electrical box, so that the view of both the Adaptor and the wiring cables can be minimized

### 2. Ducted and Air Handler Unit

Applicable models: CDXS, CXTQ, FBQ, FDMQ, FDXS, FTQ, FXDQ, FXMQ, FXSQ, FXTQ

For the ducted indoor unit, the Translation Adaptor can be mounted to the side of the indoor unit or on top of the indoor unit by the adhesive tape. The translator box can also be mounted to a nearby surface that is sturdy enough to hold the Adaptor. Select a location that will provide access to the indoor unit electrical box

### 3. Ceiling Cassette Units

Applicable models: FCQ, FFQ, FXEQ, FXFQ, FXZQ

For the ceiling cassette indoor unit, the Translation Adaptor can be mounted on top or the side of the indoor unit by the adhesive tape. The translator box can also be mounted on a surface above the ceiling using the provided screws. Select a location that will provide access to the indoor unit electrical box.

### 4. Ceiling suspended Units

Applicable models: FHQ, FXHQ, FXUQ

For the ceiling suspended indoor units, the Translation Adaptor can be mounted on top of the indoor unit by the adhesive tape (for FXUQ). The Adaptor can also be mounted above the ceiling. Select a location that will provide access to the indoor unit electrical box.

### 5. Floor-mounted and Floor Standing Units

Applicable models: FVXS, FXLQ, FXMQ, FXNQ

For the floor-mounted and floor standing unit, the translator box shall be mounted by the side of the indoor unit. Select a location that minimizes the view of the Adaptor and the wiring, as well as, provide access to the indoor unit electrical box.

## Mounting

The Translation Adaptor provides two mounting approaches. For the wall-mounted unit, the front cover is optional if the adaptor is mounted inside the piping chase.

### 1. Mount with two screws

Screws (provided) are used to mount the Adaptor to the available wall surface. Do not use screws to mount the Adaptor directly to the indoor unit. Use the two screws to mount the backplate onto the selected surface.

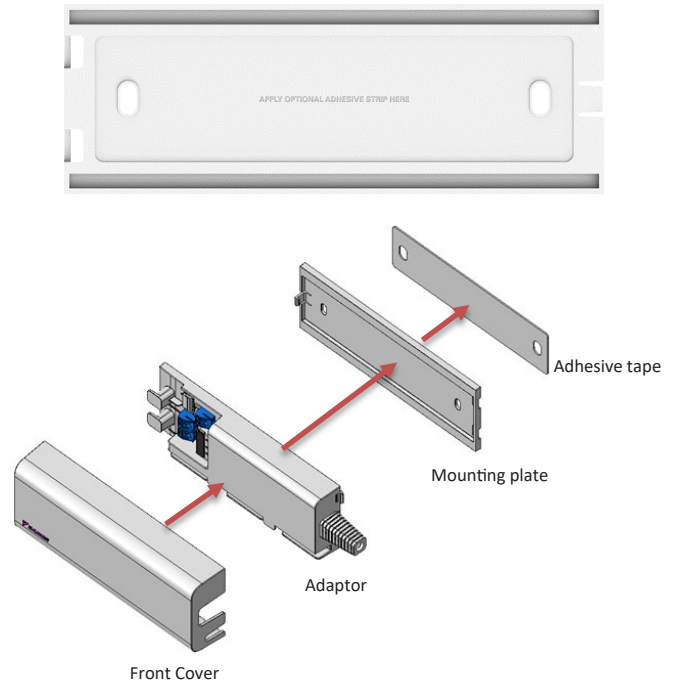
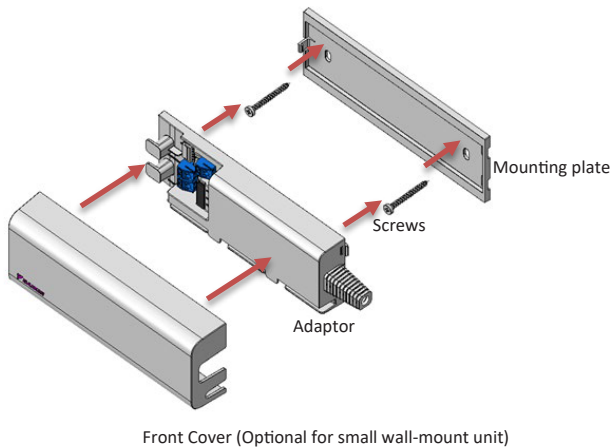

### 2. Mount with double-sided adhesive tape

Double-sided adhesive tape is used to mount the translator box onto the indoor unit directly. The mounting plate has a recess to place the adhesive tape to minimize the gap between the mounting plate and the mounting surface. Use the text "APPLY OPTIONAL ADHESIVE STRIP HERE" to identify the back side of the mounting plate.

To ensure excellent durability performance of the adhesive tape, the following steps are required in applying this adhesive tape:

- Make sure the mounting surface is clean. It is suggested to use a 50:50 mixture of isopropyl alcohol and water to clean the surface to remove any dust or oils. If the surface is not properly cleaned, the adhesive will not create a chemical adhesive bond.
- For flat surface, use the adhesive tape that is provided in the package. Firm application pressure for 30 seconds develops better adhesive contact and helps improve adhesive chemical bond strength.
- For non-flat surface applications, the installer may need to use thicker adhesive tape such as 3M Super Strength Molding Tape 03609 in order to provide more contact compliance on curved surfaces.

## Wiring

### 1. Overview

The translator box is connected between the indoor unit and the Daikin One+ Thermostat. It obtains power from the indoor unit power termination or external power source. The following figures give an overview of the wiring.

- For S21 Indoor Units

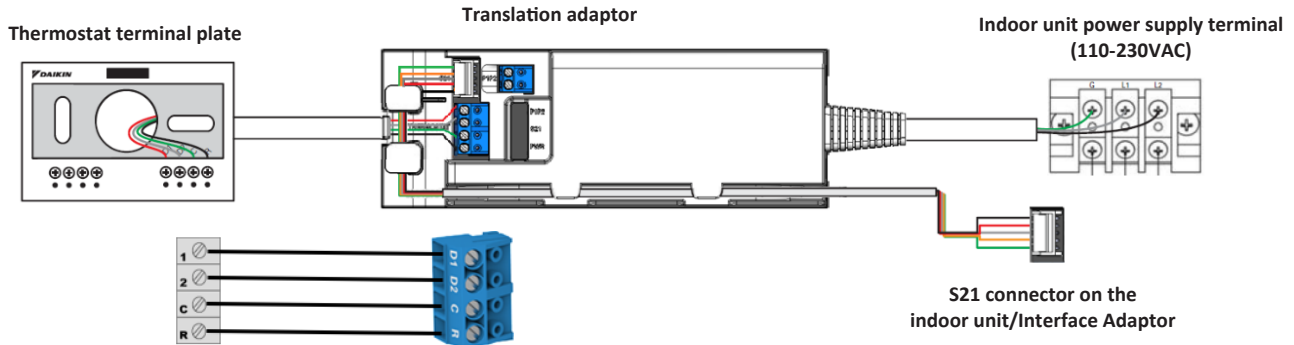

- For P1P2 Indoor Units

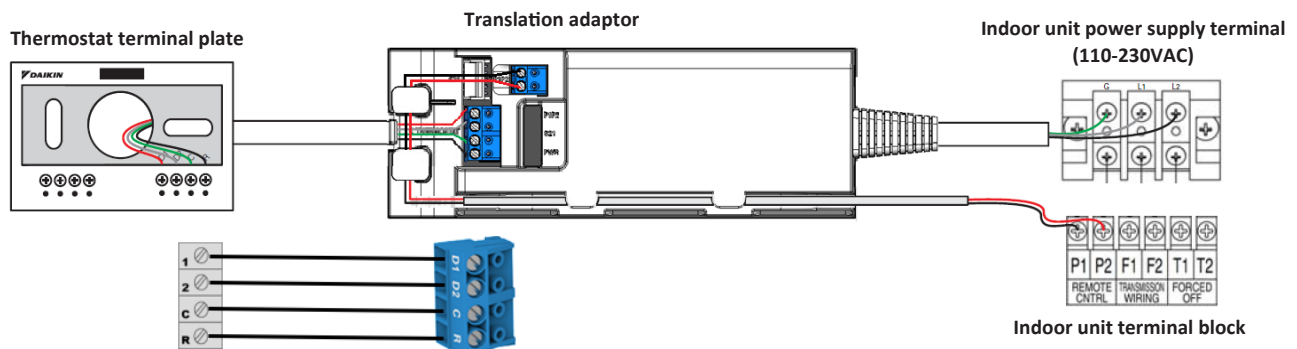

The wiring requirement is listed in the following table:

Wire Name	Type	Connected to	Max Length
High-Voltage Power Line	3-wire, Included in the package	Indoor unit power terminal or external power source	5 1/2 ft
Thermostat Wire	Field-supplied, 18 AWG, 4-conductor non-shielded wire	Daikin One+ Thermostat	125 ft
S21 Communication Wire	5-conductor wire with connectors, included in the package	S21 Terminal on the indoor unit PCB or S21 Terminal on the Interface adaptor	5.5 ft
P1P2 Communication Wire	Field-supplied, 18 AWG, 2-conductor non-shielded <b>stranded</b> wire	P1P2 Terminal on the indoor unit	6 ft*

\*Max P1P2 wire length is 1640 ft

Only one of the communication terminals shall be used per indoor unit. **Never use the S21 terminal and the P1P2 terminal at the same time.** The following table lists the communication terminal for each indoor unit model.

Indoor Unit Model	Communication Terminal
CDXS, CTXS, FDXS, FTK_N, FTX_N, FTX_U, FTXG, FTXR, FTXS, FVXS	S21 Terminal
CXTQ, FAQ, FBQ, FDMQ, FTQ, FCQ, FHQ, FFQ, FXAQ, FXDQ, FXEQ, FXFQ, FXHQ, FXLQ, FXMQ, FXNQ, FXSQ, FXTQ, FXUQ, FXZQ	P1P2 Terminal

2. Thermostat Wiring

The Daikin One+ Smart Thermostat obtains power from the adaptor directly. It is recommended to wire the thermostat wire first before wiring the S21 or P1P2 communication wire. The thermostat terminal (D1, D2, C, R) on the adaptor shall be connect to the (1, 2, C, R) terminals on terminal plate of the Daikin One+ Thermostat by 18AWG 4-conductor non-shielded wire. Make sure the termination combinations in the image below are followed.

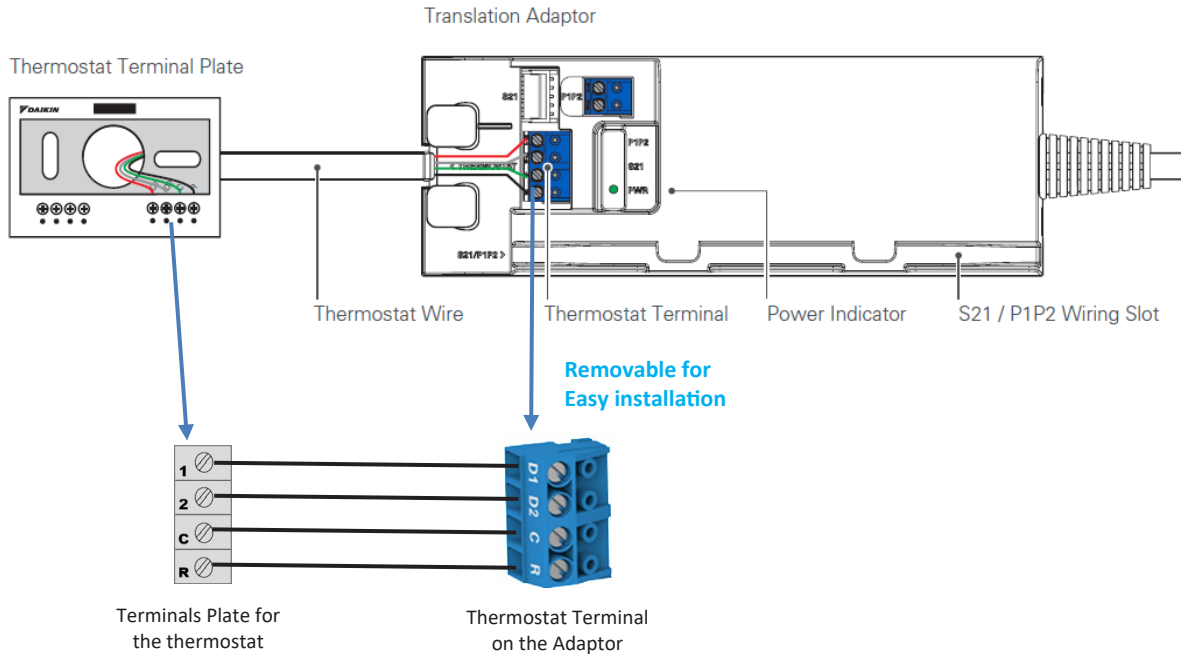

3. S21 Communication Wiring

S21 Communication terminal is used for S21 indoor units (Single and Multi-splits) only. The S21 wiring cable is included in the package. The S21 wiring cable shall make use of the 2 anchors and the S21/P1P2 wiring slot to route wiring cable towards the high voltage side of the Adaptor.



The S21 wiring cable is connected to the S21 connector on the indoor unit PCB or to the S21 connector on the Interface Adaptor (dependent upon indoor unit model). Refer to the indoor unit installation manual on how to find and access the S21 connector.

Some of the single-zone and multi-zone indoor units do not have an S21 connector on the indoor unit PCB. For those indoor units, an Interface Adaptor needs to be ordered separately. The following table summarizes the indoor unit models that require an Interface Adaptor and the model number of the required interface adaptor.

Indoor Unit Models	Required Interface Adaptor
FTX09NMVJU, FTX12NMVJU, FTK09NMVJU, FTK12NMVJU,	KRP067A41E
FTX15NMVJU, FTX18NMVJU, FTX24NMVJU, FTK18NMVJU, FTK24NMVJU	KRP980B2E

4. P1P2 Communication Wiring

The P1P2 Communication terminal is used for P1P2 indoor units only. Use 18-2-non-shielded **stranded** wire to connect the P1P2 terminal on the Adaptor to the P1P2 terminal of the applicable indoor unit. Do not use the S21 terminal if P1P2 terminal is used.

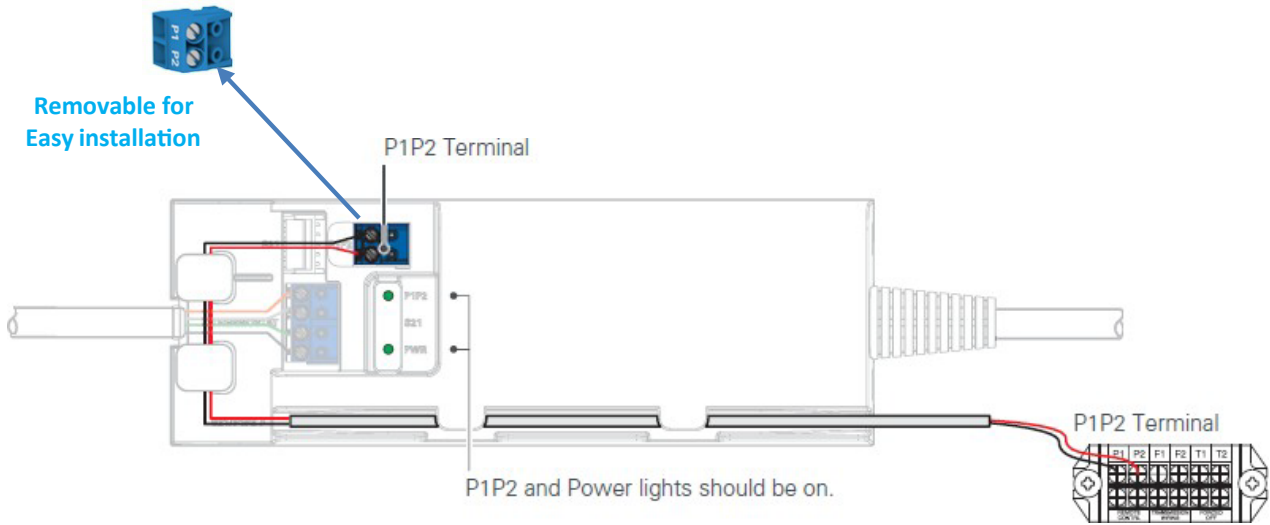

5. Power Supply

The P1P2 Communication terminal is used for P1P2 indoor units only. Use 18-2-non-shielded stranded wire to connect the P1P2 terminal on the Adaptor to the P1P2 terminal of the applicable indoor unit. Do not use the S21 terminal if P1P2 terminal is used.

**WARNING**

**HIGH VOLTAGE**  
DISCONNECT ALL POWER BEFORE SERVICING OR INSTALLING THIS UNIT. MULTIPLE POWER SOURCES MAY BE PRESENT. FAILURE TO DO SO MAY CAUSE PROPERTY DAMAGE, PERSONAL INJURY OR DEATH.

Obtain power from indoor unit:

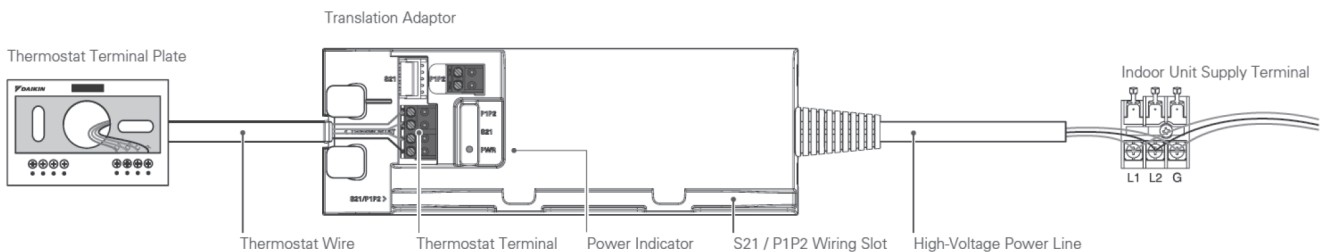

Obtain power from external power supply:



6. Check Power Indicators

Once the wiring and installation is complete, turn on power to the indoor unit. Use the power indicator on the Adaptor to confirm whether the wiring is successful or not. The LED light for 'Power' indicates the power is connected successfully. If the indoor unit has the S21 termination, the 'S21' LED will be on; If the indoor unit has the P1P2 termination, the 'P1P2' LED will be on. Once power and communication has been verified use the rubber grommet to cover the LEDs. This will prevent the LED light from bleeding through the indoor unit when the indoor unit and adaptor are completely installed.

LED lights status for S21 units

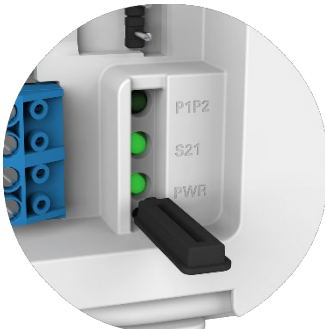

LED lights status for P1P2 units

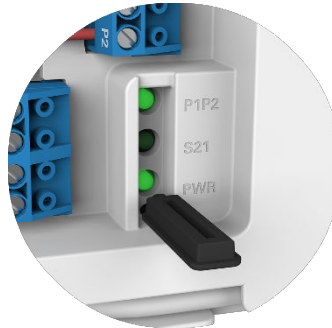

For some wall-mounted units, the front cover shall be removed to fit inside the piping chase. For other units, put the front cover back onto the translator box and press down until it snaps into place.



### **CUSTOMER FEEDBACK**

Daikin is very interested in all product comments.

Please fill out the feedback form on the following link:

<https://daikincomfort.com/contact-us>

You can also scan the QR code on the right to be directed to the feedback page.



Our continuing commitment to quality products may mean a change in specifications without notice.

© 2020 **DAIKIN MANUFACTURING COMPANY, L.P.**

19001 Kermier Rd. Waller, TX 77484

[www.daikincomfort.com](http://www.daikincomfort.com)