



aerospace
climate control
electromechanical
filtration
fluid & gas handling
hydraulics
pneumatics
process control
sealing & shielding



FOR HVAC/R
RATED UP TO 48 BAR

ZoomLock®

FLAME-FREE
REFRIGERANT FITTINGS

ZoomLock® Flame-Free Refrigerant Fittings

Catalog K-1, May 2018



ENGINEERING YOUR SUCCESS.

PARKER SAFETY GUIDE FOR SELECTING AND USING ZOOMLOCK FITTINGS AND RELATED ACCESSORIES

WARNING

FAILURE TO FOLLOW INSTALLATION INSTRUCTIONS, IMPROPER SELECTION OR IMPROPER USE OF ZOOMLOCK FITTINGS AND RELATED ACCESSORIES (“PRODUCTS”) CAN CAUSE DEATH, PERSONAL INJURY AND PROPERTY DAMAGE. POSSIBLE CONSEQUENCES OF FAILURE, IMPROPER SELECTION OR IMPROPER USE OF THESE PRODUCTS INCLUDE BUT ARE NOT LIMITED TO:

- Fittings thrown off at high speed.
- High velocity fluid discharge.
- Explosion or burning of the conveyed fluid.
- Electrocution from high voltage electric power lines.
- Contact with suddenly moving or falling objects that are controlled by the conveyed fluid.
- Injections by high-pressure fluid discharge.
- Dangerously whipping copper line.
- Contact with conveyed fluids that may be hot, cold, toxic or otherwise injurious.
- Sparking or explosion caused by static electricity buildup or other sources of electricity.
- Sparking or explosion from flammable liquids.

BEFORE SELECTING OR USING ANY OF THESE PRODUCTS, IT IS IMPORTANT THAT YOU READ AND FOLLOW THE INSTALLATION INSTRUCTIONS.

KEY STEPS FOR SAFETY

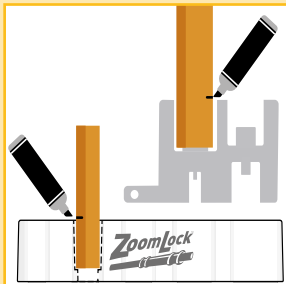

**MARK
TUBE DEPTH**

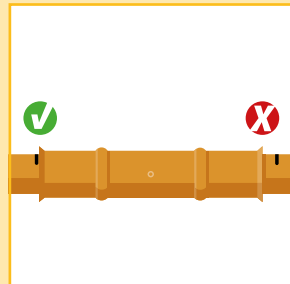

**CHECK
TUBE DEPTH**

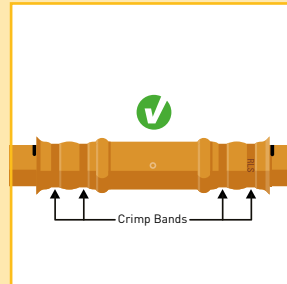

**CHECK FOR “RLS”
MARK AFTER CRIMP**

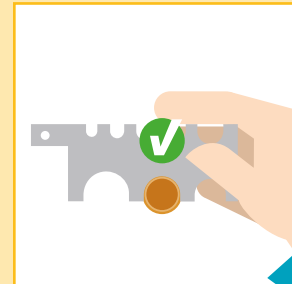

**CHECK CRIMP
WITH CRIMP GAUGE**

⚠ WARNING – USER RESPONSIBILITY

Failure or improper selection or improper use of the products described herein or related items can cause death, personal injury and property damage.

This document and other information from Parker Hannifin Corporation, its subsidiaries and authorized distributors provide product or system options for further investigation by users having technical expertise.

The user, through its own analysis and testing, is solely responsible for making the final selection of the system and components and assuring that all performance, endurance, maintenance, safety and warning requirements of the application are met. The user must analyze all aspects of the application, follow applicable industry standards, and follow the information concerning the product in the current product catalog and in any other materials provided from Parker or its subsidiaries or authorized distributors.

To the extent that Parker or its subsidiaries or authorized distributors provide component or system options based upon data or specifications provided by the user, the user is responsible for determining that such data and specifications are suitable and sufficient for all applications and reasonably foreseeable uses of the components or systems.

For safety information see the Safety Guide at www.parker.com/safety or call 1-800-CParker.

OFFER OF SALE

The items described in this document are hereby offered for sale by Parker Hannifin Corporation, its subsidiaries or its authorized distributors. This offer and its acceptance are governed by the provisions stated in the detailed “Offer of Sale” elsewhere in this document or available at www.parker.com.

Catalog K-1, May 2018 supersedes Catalog K-1, January 2018 and all prior publications.

ZoomLock Flame-Free Refrigerant Fittings

Table of Contents

Introduction	4
Flame-Free Refrigerant Fittings	
Couplings	6
Slip Couplings	6
Long Radius Elbows	7
Tees	7
Reducers	8
Caps	9
SAE Flare	9
Reducing Bushings	10
Long Radius Street Elbow	10
Elbow - 45°	11
Y-Joints	11
P Traps	12
Filter driers - Moisture and liquid indicators	13
Ball Valves - Solenoid Valves	14
Crimping Tools	15
Tool Kits - Jaw Kits	16
Crimping Tools and Jaw Selection	17
Replacement Parts and Accessories	19
Installation Instructions	20
Troubleshooting and Frequently Asked Questions	22
Performance Data	26
ICC-ES Evaluation Report	27
Helium Leak Test Report	29
Time and Motion Study	31



Fittings
pages 6-12

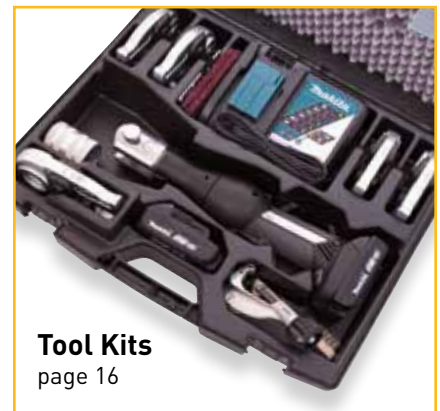

Tool Kits
page 16



Jaw Kits
page 16

Compatible Components

To make a system convenient to install, ODM x ODM ZoomLock compatible components are available including:

- Ball Valves
- Filter-Driers
- Moisture and Liquid Indicators
- Solenoid Valves



ATTENTION!

WARRANTY COULD BE VOID IF ZOOMLOCK IS NOT APPLIED PER INSTRUCTIONS! CAREFULLY READ ALL INSTALLATION INSTRUCTIONS (SEE PAGES 20-21) AND WATCH VIDEOS.



<http://solutions.parker.com/zoomvid>

ZoomLock®

FLAME-FREE REFRIGERANT FITTINGS

Increase productivity and profitability

ZoomLock® flame-free refrigerant fittings are specially designed to work without brazing, which automatically makes your job simpler and faster when joining copper tubes.

Professionals who have tried ZoomLock flame-free refrigerant fittings report their time and labor costs on tube connections are typically reduced 60% on average by eliminating the need for brazing. The biggest benefits are **more productivity and increased profit**, but there are also many other exciting advantages to flame-free tube connecting.



The ZoomLock Advantage

- For HVAC/R up to 48 bar
- Huge labor and time savings
- Less equipment required
- Safer conditions
no fire hazards
- No hot-work permits
- No need to
nitrogen-purge
- More flexible access to
job sites



ZoomLock Flame-Free Refrigerant Fittings



Applications

- High Pressure HVAC/R
- Glycol
- Non-Potable Water

Product Parameters

- **Continuous Operating Temperature:**
250°F / 121°C
- **O-Ring Temperature Rating:**
-40°F to +300°F
-40°C to +149°C
- **Maximum Rated Pressure (MRP):**
700 psi / 48 bar
- **Minimum Burst Pressure (UL 207):**
2,100 psi / 145 bar
- **Vacuum Pressure Capability:**
20 Microns
- **External Leak Rate:**
< 0,003 Liters (0,1 ounces) of Helium per Year at Operating Pressure Range
- **Vibration Resistance:**
Conforms to UL109
- **Size Availability (Inches):**
1/4, 5/16, 3/8, 1/2, 5/8, 3/4, 7/8, 1-1/8, 1-3/8

Fitting Materials

- **Fitting Body:**
Refrigerant Grade Copper, per ASTM-B75 or ASTM-B743
- **O-Ring:**
HNBR

Fitting Warranty

- 5 years from date of install.

Compatibility

- **Approved Oils:** Mineral Oil, POE, PVE, PAG
- **Approved Tubing Materials:**
Copper to Copper Connections
- **Approved Tubing Tolerance:**
ASTM B280, UNI EN 12735
- **Approved Copper Tubing Types for Use with Klauke® 19 kN Compatible Jaws:**
Hard Copper (Drawn)
- 1/4" – 1-3/8" Type ACR, M, L, K
Soft Copper (Annealed)
- 1/4" – 1-3/8" Type ACR, L, K
- **Approved Copper Tubing Types for Use with Klauke® 15 kN Compatible Jaws:**
Hard Copper (Drawn)
- 1/4" – 1-1/8" Type ACR, M, L
- Type K only up to 7/8"
Soft Copper (Annealed)
- 1/4" – 1-1/8" Type ACR, L
- Type K only up to 7/8"

Agency Approvals and Certifications

- UL Listed: 207, SA#33958, SDTW(7) (Except where noted)
- UL Listed: Approved use for Field & Factory installations
- TÜV
 - Burst Test
 - Leak Test
 - Mechanical Strength
- ASHRAE-15, ANSI 15, ASME B31.5, ANSI 31.5
- ICC-ES, PMG-1296
2018, 2015, 2012, 2009, 2006
International Mechanical Code (IMC)
2018, 2015, 2012, 2009, 2006
International Residential Code (IRC)

Approved Refrigerants

- | | | |
|---------|---------|-------------------|
| ■ 32* | ■ 424A | ■ 453A |
| ■ 125 | ■ 427A | ■ 454A* |
| ■ 134a | ■ 434A | ■ 454B* |
| ■ 143a* | ■ 437A | ■ 454C* |
| ■ 152a* | ■ 438A | ■ 455A* |
| ■ 227ea | ■ 442A | ■ 456A |
| ■ 290* | ■ 444A* | ■ 457A* |
| ■ 404A | ■ 444B* | ■ 458A |
| ■ 407A | ■ 445A* | ■ 507A |
| ■ 407B | ■ 446A* | ■ 513A |
| ■ 407C | ■ 447A* | ■ 513B |
| ■ 407F | ■ 448A | ■ 515A |
| ■ 407G | ■ 449A | ■ 515B |
| ■ 407H | ■ 449B | ■ 600* |
| ■ 410A | ■ 449C | ■ 600a* |
| ■ 417A | ■ 450A | ■ 718 |
| ■ 421A | ■ 451A* | ■ 1234yf* |
| ■ 422A | ■ 451B* | ■ 1234ze* |
| ■ 422B | ■ 452A | ■ Ethylene Glycol |
| ■ 422C | ■ 452B* | |
| ■ 422D | ■ 452C | |

* Flammable refrigerants. Check with local building or mechanical code officials.

Refer to ZoomLock.com for the latest approved refrigerants list.

2018, 2015, 2012, 2009, 2006
Uniform Mechanical Code (UMC)

- CRN - Approved for couplings and 90 degree elbows.

Patents

- U.S. Patent No.
 - 9,145,992
 - 9,638,361
 - D730,494
- Australian Patent No.
 - 2012362443
- Japanese Patent No.
 - 6051468



ZoomLock Flame-Free Refrigerant Fittings

Couplings



Dimensions

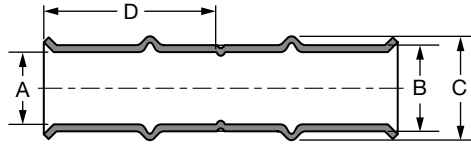

Size	Part Number	Description	Dimensions							
			A		B		C		D	
			Inch	mm	Inch	mm	Inch	mm	Inch	mm
1/4	770500	PZK-C4-HNBR	0.26	6.6	0.34	8.6	0.45	11.5	0.95	24.1
5/16	770501	PZK-C5-HNBR	0.32	8.2	0.40	10.2	0.52	13.1	0.93	23.6
3/8	770502	PZK-C6-HNBR	0.39	9.8	0.47	11.8	0.59	15.0	0.98	24.9
1/2	770503	PZK-C8-HNBR	0.51	13.0	0.59	15.0	0.73	18.6	1.25	31.8
5/8	770504	PZK-C10-HNBR	0.64	16.1	0.74	18.7	0.89	22.5	1.24	31.5
3/4	770505	PZK-C12-HNBR	0.76	19.3	0.88	22.4	1.07	27.2	1.29	32.8
7/8	770506	PZK-C14-HNBR	0.89	22.5	1.02	25.8	1.19	30.2	1.31	33.3
1	770513	PZK-C16-HNBR	1.01	25.7	1.36	34.6	1.36	34.6	1.31	33.3
1-1/8	770507	PZK-C18-HNBR	1.14	28.8	1.29	32.6	1.44	36.7	1.29	32.8
1-3/8*	770508	PZK-C22-HNBR	1.39	35.3	1.54	39.1	1.75	44.5	1.57	39.9

Slip Couplings



Dimensions

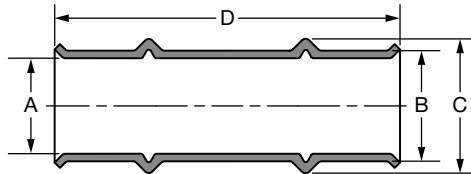

Size	Part Number	Description	Dimensions							
			A		B		C		D	
			Inch	mm	Inch	mm	Inch	mm	Inch	mm
1/4	770550	PZK-RC4-HNBR	0.26	6.6	0.34	8.6	0.45	11.5	2.00	50.8
3/8	770552	PZK-RC6-HNBR	0.39	9.8	0.47	11.8	0.59	15.0	2.05	52.1
1/2	770553	PZK-RC8-HNBR	0.51	13.0	0.59	15.0	0.73	18.6	2.74	69.6
5/8	770554	PZK-RC10-HNBR	0.64	16.1	0.74	18.7	0.89	22.5	2.75	69.9
3/4	770555	PZK-RC12-HNBR	0.76	19.3	0.88	22.4	1.07	27.2	2.75	69.9
7/8	770556	PZK-RC14-HNBR	0.89	22.5	1.02	25.8	1.19	30.2	2.74	69.9
1-1/8	770557	PZK-RC18-HNBR	1.14	28.8	1.29	32.6	1.44	36.7	2.77	70.4
1-3/8*	770558	PZK-RC22-HNBR	1.39	35.3	1.54	39.1	1.75	44.5	1.57	39.9

*ZoomLock 1-3/8" fittings can only be crimped with 19 kN Klauke tools.

ZoomLock Flame-Free Refrigerant Fittings

Long Radius Elbows



Dimensions

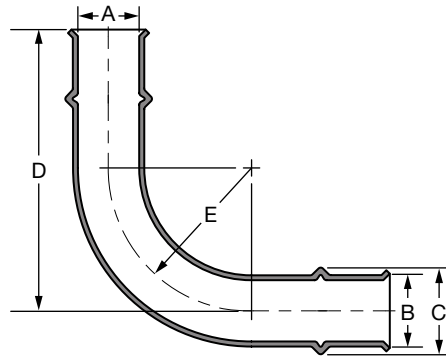

Size	Part Number	Description	Dimensions									
			A		B		C		D		E (Ref.)	
			Inch	mm	Inch	mm	Inch	mm	Inch	mm	Inch	mm
1/4	770600	PZK-90E4-HNBR	0.26	6.6	0.34	8.6	0.45	11.5	2.01	51.1	0.50	12.7
5/16	770601	PZK-90E5-HNBR	0.32	8.2	0.40	10.2	0.52	13.1	2.13	54.1	0.60	15.2
3/8	770602	PZK-90E6-HNBR	0.39	9.8	0.47	11.8	0.59	15.0	2.27	57.7	0.65	16.5
1/2	770603	PZK-90E8-HNBR	0.51	13.0	0.59	15.0	0.73	18.6	2.88	73.2	0.90	22.9
5/8	770604	PZK-90E10-HNBR	0.64	16.1	0.74	18.7	0.89	22.5	3.21	81.4	1.13	28.7
3/4	770605	PZK-90E12-HNBR	0.76	19.3	0.88	22.4	1.07	27.2	3.47	88.0	1.50	38.1
7/8	770606	PZK-90E14-HNBR	0.89	22.5	1.02	25.8	1.19	30.2	3.75	95.3	2.25	57.2
1-1/8	770607	PZK-90E18-HNBR	1.14	28.8	1.29	32.6	1.44	36.7	4.29	108.8	2.85	72.4
1-3/8*	770608	PZK-90E22-HNBR	1.39	35.3	1.54	39.1	1.75	44.5	4.54	115.3	3.05	77.5

Tees



Dimensions

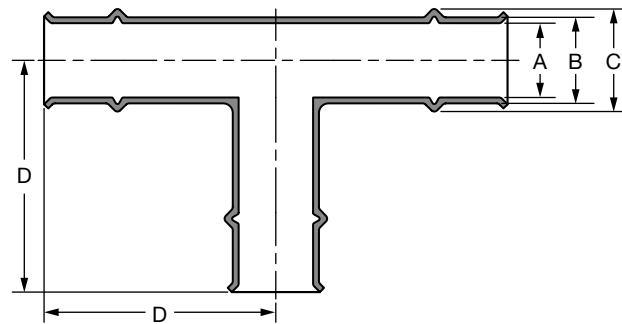

Size	Part Number	Description	Dimensions							
			A		B		C		D	
			Inch	mm	Inch	mm	Inch	mm	Inch	mm
3/8	770702	PZK-T6-HNBR	0.39	9.8	0.47	11.8	0.59	15.0	1.63	41.4
1/2	770703	PZK-T8-HNBR	0.51	13.0	0.59	15.0	0.72	18.2	2.23	56.6
5/8	770704	PZK-T10-HNBR	0.64	16.1	0.74	18.7	0.87	22.0	2.29	58.2
3/4	770705	PZK-T12-HNBR	0.76	19.3	0.88	22.4	1.05	26.6	2.37	60.2
7/8	770706	PZK-T14-HNBR	0.89	22.5	1.02	25.8	1.19	30.2	2.44	62.0
1-1/8	770707	PZK-T18-HNBR	1.14	28.8	1.29	32.6	1.44	36.7	2.56	65.0
1-3/8*	770708	PZK-T22-HNBR	1.39	35.2	1.54	39.0	1.75	44.4	2.75	69.9

*ZoomLock 1-3/8" fittings can only be crimped with 19 kN Klauke tools.

ZoomLock Flame-Free Refrigerant Fittings

Reducers



Dimensions

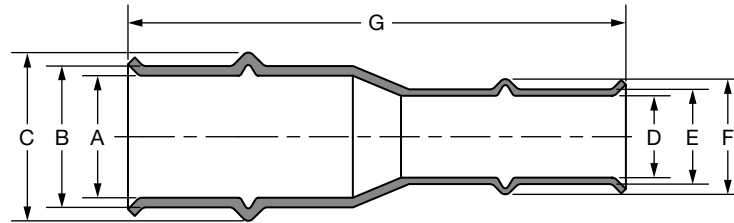

Size	Part Number	Description	Dimensions													
			A		B		C		D		E		F		G	
			Inch	mm	Inch	mm	Inch	mm	Inch	mm	Inch	mm	Inch	mm	Inch	mm
3/8 in to 1/4	770800	PZK-R64-HNBR	0.39	9.8	0.47	11.8	0.59	15.0	0.26	6.6	0.34	8.6	0.45	11.5	2.20	55.9
1/2 in to 1/4	770808	PZK-R84-HNBR	0.51	13.0	0.59	15.0	0.73	18.6	0.26	6.6	0.34	8.6	0.45	11.5	2.63	66.8
1/2 in to 3/8	770801	PZK-R86-HNBR	0.51	13.0	0.59	15.0	0.73	18.6	0.39	9.8	0.47	11.8	0.59	15.0	2.63	66.8
5/8 in to 1/4	770809	PZK-R104-HNBR	0.64	16.1	0.74	18.7	0.89	22.5	0.26	6.6	0.34	8.6	0.45	11.5	2.70	68.6
5/8 in to 3/8	770810	PZK-R106-HNBR	0.64	16.1	0.74	18.7	0.89	22.5	0.39	9.8	0.47	11.8	0.59	15.0	2.70	68.6
5/8 in to 1/2	770802	PZK-R108-HNBR	0.64	16.1	0.74	18.7	0.87	22.0	0.51	13.0	0.59	15.0	0.72	18.2	3.00	76.2
3/4 in to 1/2	770811	PZK-R128-HNBR	0.76	19.3	0.88	22.4	1.05	26.6	0.51	13.0	0.59	15.0	0.72	18.2	3.10	78.7
3/4 in to 5/8	770803	PZK-R1210-HNBR	0.76	19.3	0.88	22.4	1.05	26.6	0.64	16.1	0.74	18.7	0.87	22.0	3.00	76.2
7/8 in to 1/2	770812	PZK-R148-HNBR	0.89	22.5	1.02	25.8	1.19	30.2	0.51	13.0	0.59	15.0	0.72	18.2	3.05	77.5
7/8 in to 5/8	770804	PZK-R1410-HNBR	0.89	22.5	1.02	25.8	1.19	30.2	0.64	16.1	0.74	18.7	0.87	22.0	3.05	77.5
7/8 in to 3/4	770805	PZK-R1412-HNBR	0.89	22.5	1.02	25.8	1.19	30.2	0.76	19.3	0.88	22.4	1.05	26.6	3.11	79.0
1 in to 7/8	770823	PZK-R1614-HNBR	1.01	25.7	1.16	29.5	1.37	34.7	0.89	22.5	1.02	25.8	1.19	30.2	3.09	78.5
1-1/8 in to 1/2	770813	PZK-R188-HNBR	1.14	28.8	1.29	32.6	1.44	36.7	0.51	13.0	0.60	15.0	0.72	18.2	3.25	82.6
1-1/8 in to 5/8	770814	PZK-R1810-HNBR	1.14	28.8	1.29	32.6	1.44	36.7	0.64	16.1	0.74	18.7	0.87	22.0	3.25	82.6
1-1/8 in to 3/4	770806	PZK-R1812-HNBR	1.14	28.8	1.29	32.6	1.44	36.7	0.76	19.3	0.88	22.4	1.05	26.6	3.25	82.6
1-1/8 in to 7/8	770807	PZK-R1814-HNBR	1.14	28.8	1.29	32.6	1.44	36.7	0.89	22.5	1.02	25.8	1.12	28.4	3.11	79.0
1-3/8 in to 7/8	770818	PZK-R2214-HNBR	1.39	35.2	1.64	41.7	1.75	44.4	0.89	22.5	1.13	28.7	1.19	30.2	3.66	93.0
1-3/8 in to 1 1/8	770819	PZK-R2218-HNBR	1.39	35.2	1.64	41.7	1.75	44.4	1.14	28.8	1.41	35.8	1.45	36.7	3.34	84.8

*ZoomLock 1-3/8" fittings can only be crimped with 19 kN Klauke tools.

ZoomLock Flame-Free Refrigerant Fittings

Caps



Dimensions

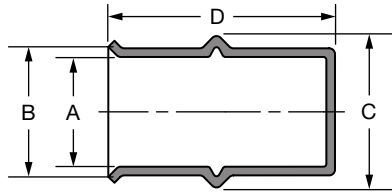

Size	Part Number	Description	Dimensions							
			A		B		C		D	
			Inch	mm	Inch	mm	Inch	mm	Inch	mm
1/4	770900	PZK-CP4-HNBR	0.26	6.6	0.34	8.6	0.45	11.5	1.11	28.2
5/16	770901	PZK-CP5-HNBR	0.32	8.2	0.40	10.2	0.52	13.1	1.11	28.2
3/8	770902	PZK-CP6-HNBR	0.39	9.8	0.47	11.8	0.59	15.0	1.13	28.7
1/2	770903	PZK-CP8-HNBR	0.51	13.0	0.59	15.0	0.72	18.2	1.47	37.3
5/8	770904	PZK-CP10-HNBR	0.64	16.1	0.74	18.7	0.87	22.0	1.56	39.6
3/4	770905	PZK-CP12-HNBR	0.76	19.3	0.88	22.4	1.05	26.6	1.57	39.9
7/8	770906	PZK-CP14-HNBR	0.89	22.5	1.02	25.8	1.19	30.2	1.60	40.6
1-1/8	770907	PZK-CP18-HNBR	1.14	28.8	1.29	32.6	1.44	36.7	2.05	52.1
1-3/8*	770908	PZK-CP22-HNBR	1.39	35.2	1.54	39.0	1.75	44.4	2.11	53.6

*ZoomLock 1-3/8" fittings can only be crimped with 19 kN Klauke tools.

SAE Flare



Dimensions

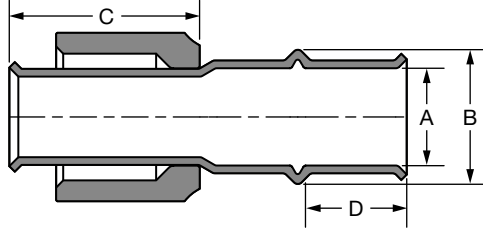

Size	Part Number	Description	Dimensions							
			A		B		C		D	
			Inch	mm	Inch	mm	Inch	mm	Inch	mm
1/4	771000	PZK-F4-HNBR	0.26	6.6	0.45	11.5	1.38	35.1	0.56	14.2
3/8	771002	PZK-F6-HNBR	0.39	9.8	0.59	15.0	1.38	35.1	0.58	14.7
1/2	771003	PZK-F8-HNBR	0.51	13.0	0.72	18.2	1.13	28.7	0.75	19.1
5/8	771004	PZK-F10-HNBR	0.64	16.1	0.87	22.1	1.48	37.6	0.75	19.1
3/4	771005	PZK-F12-HNBR	0.76	19.3	1.05	26.7	1.48	37.6	0.80	20.3

ZoomLock Flame-Free Refrigerant Fittings

Reducing Bushings



Dimensions

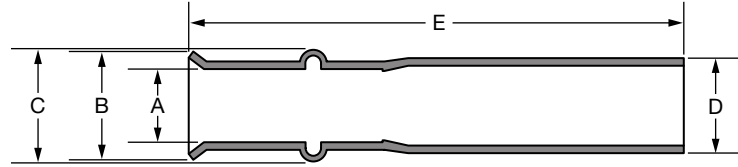

Size	Part Number	Description	Dimensions									
			A		B		C		D		E	
			Inch	mm	Inch	mm	Inch	mm	Inch	mm	Inch	mm
1/2 to 3/8	771502	PZK-B86-HNBR	0.39	9.8	0.56	14.2	0.59	15.0	0.47	11.8	2.50	63.5
5/8 to 1/2	771505	PZK-B108-HNBR	0.51	13.0	0.68	17.3	0.72	18.2	0.59	15.0	2.95	74.9
3/4 to 5/8	771507	PZK-B1210-HNBR	0.64	16.1	0.84	21.3	0.87	22.1	0.74	18.7	2.98	75.7
7/8 to 3/4	771510	PZK-B1412-HNBR	0.76	19.3	1.02	25.9	1.05	26.7	0.88	22.4	3.04	77.2
1-1/8 to 7/8	771514	PZK-B1814-HNBR	0.89	22.5	1.10	27.9	1.19	30.2	1.02	25.8	3.06	77.7
1-3/8 to 1-1/8*	771519	PZK-B2218-HNBR	1.14	28.8	1.40	35.6	1.45	36.8	1.29	32.6	3.12	79.2

*ZoomLock 1-3/8" fittings can only be crimped with 19 kN Klauke tools.

Long Radius Street Elbow



Dimensions

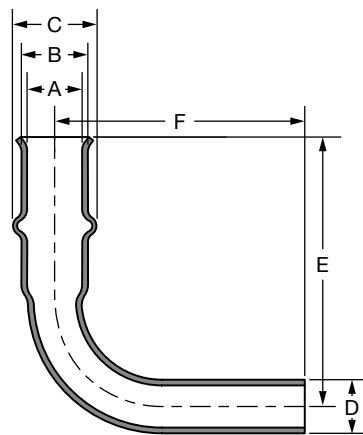

Size	Part Number	Description	Dimensions											
			A		B		C		D		E		F	
			Inch	mm	Inch	mm	Inch	mm	Inch	mm	Inch	mm	Inch	mm
3/8	771302	PZK-90SE6-HNBR	0.39	9.8	0.54	13.7	0.59	15.0	0.38	9.5	1.89	48.0	1.75	44.5
1/2	771303	PZK-90SE8-HNBR	0.51	13.0	0.69	17.5	0.72	18.2	0.50	12.7	2.65	67.3	2.56	65.0
5/8	771304	PZK-90SE10-HNBR	0.64	16.1	0.84	21.3	0.87	22.1	0.63	15.9	2.81	71.4	2.64	67.1
3/4	771305	PZK-90SE12-HNBR	0.76	19.3	1.03	26.2	1.05	26.7	0.75	19.1	3.15	80.0	3.00	76.2
7/8	771306	PZK-90SE14-HNBR	0.89	22.5	1.14	29.0	1.19	30.2	0.88	22.2	3.40	86.4	3.25	82.6
1-1/8	771307	PZK-90SE18-HNBR	1.14	28.8	1.41	35.8	1.45	36.7	1.13	28.6	3.93	99.8	3.80	96.5
1-3/8*	771308	PZK-90SE22-HNBR	1.39	35.2	1.68	42.7	1.75	44.4	1.38	34.9	4.51	114.6	4.38	111.3

*ZoomLock 1-3/8" fittings can only be crimped with 19 kN Klauke tools.

ZoomLock Flame-Free Refrigerant Fittings

Elbow - 45°

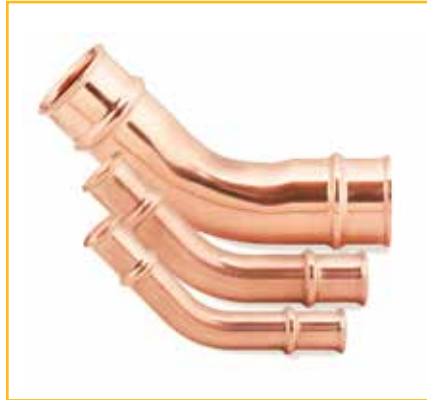

Dimensions

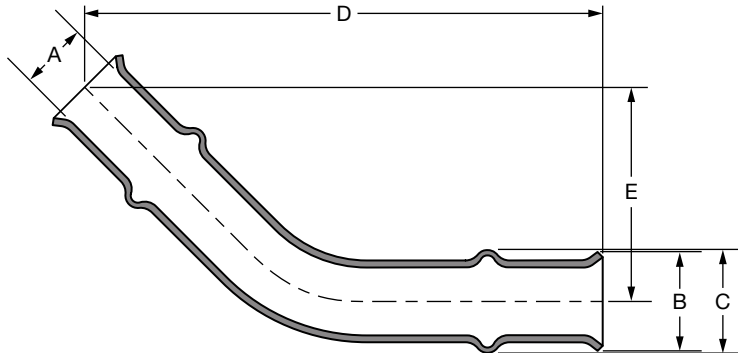

Size	Part Number	Description	Dimensions									
			A		B		C		D		E	
			Inch	mm	Inch	mm	Inch	mm	Inch	mm	Inch	mm
3/8	771402	PZK-45E6-HNBR	0.39	9.8	0.56	14.2	0.59	15.0	2.96	75.2	1.26	32.0
1/2	771403	PZK-45E8-HNBR	0.51	13.0	0.71	18.0	0.73	18.6	3.72	94.5	1.54	39.1
5/8	771404	PZK-45E10-HNBR	0.64	16.1	0.86	21.8	0.88	22.5	3.97	100.8	1.64	41.7
3/4	771405	PZK-45E12-HNBR	0.76	19.3	1.02	25.9	1.06	27.0	4.12	104.6	1.70	43.2
7/8	771406	PZK-45E14-HNBR	0.89	22.5	1.13	28.7	1.19	30.1	4.38	111.3	1.82	46.2
1-1/8	771407	PZK-45E18-HNBR	1.14	28.8	1.41	35.8	1.45	36.7	4.84	122.9	2.00	50.8
1-3/8*	771408	PZK-45E22-HNBR	1.39	35.2	1.68	42.7	1.75	44.4	5.67	144.0	2.55	64.8

*ZoomLock 1-3/8" fittings can only be crimped with 19 kN Klauke tools.

Y-Joints

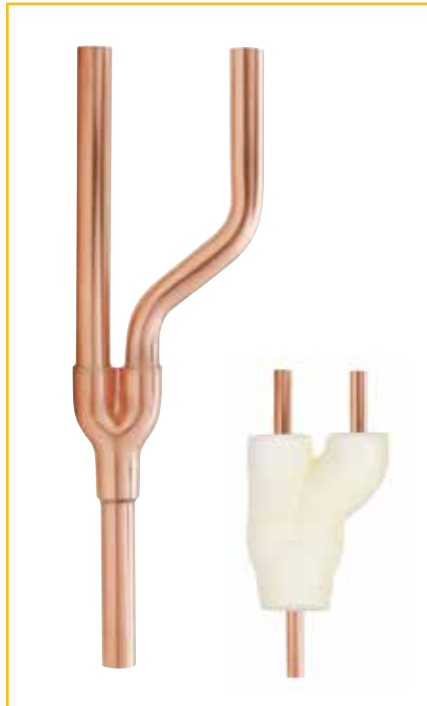

Dimensions

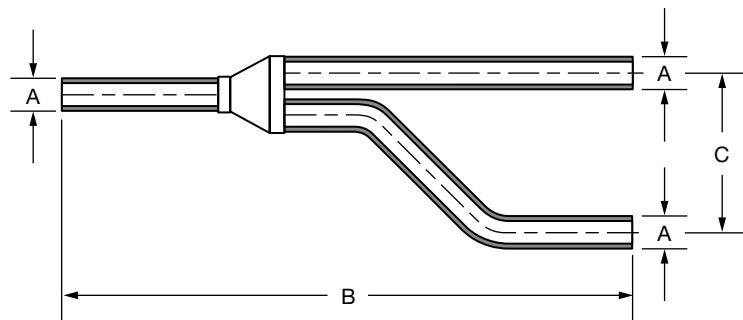

Size	Part Number	Description	Dimensions					
			A		B		C	
			Inch	mm	Inch	mm	Inch	mm
3/8	771102	PZK-Y6-NA	0.38	9.5	7.59	192.0	2.37	60.0
1/2	771103	PZK-Y8-NA	0.50	12.7	8.97	227.0	2.49	63.0
5/8	771104	PZK-Y10-NA	0.63	15.9	9.49	240.0	2.61	66.0
3/4	771105	PZK-Y12-NA	0.75	19.1	10.20	258.0	2.73	69.0
7/8	771106	PZK-Y14-NA	0.88	22.2	12.13	307.0	2.89	73.0
1-1/8	771107	PZK-Y18-NA	1.13	28.6	13.16	333.0	3.56	90.0

Note: Not UL Approved. Includes foam insulation as shown.

ZoomLock Flame-Free Refrigerant Fittings

P-Traps



Dimensions

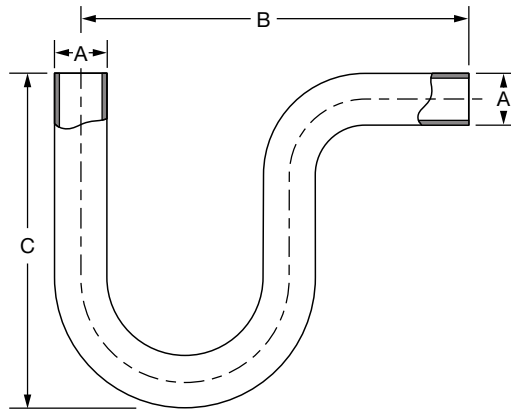

Size	Part Number	Description	Dimensions					
			A		B		C	
			Inch	mm	Inch	mm	Inch	mm
1/2	771203	PZK-PT8-NA	0.50	12.7	5.12	130.0	3.54	90.0
5/8	771204	PZK-PT10-NA	0.63	15.9	5.12	130.0	3.62	92.0
3/4	771205	PZK-PT12-NA	0.75	19.1	5.91	150.0	4.25	108.0
7/8	771206	PZK-PT14-NA	0.88	22.2	6.69	170.0	4.65	118.0
1-1/8	771207	PZK-PT18-NA	1.13	28.6	8.27	210.0	5.98	152.0
1-3/8*	771208	PZK-PT22-NA	1.38	34.9	10.24	260.0	7.48	190.0

Note: Not UL Approved. *ZoomLock 1-3/8" fittings can only be crimped with 19 kN Klauke tools.

ZoomLock Flame-Free Refrigerant Fittings

Filters-driers *Catch-All*



Size (ODM x ODM)	Part Numbers	Description
3/8"	761000	C-083-PZK
3/8"	761200	C-163-PZK
1/2"	761201	C-164-PZK
5/8"	761202	C-165-PZK
1/2"	761300	C-304-PZK
5/8"	761301	C-305-PZK
7/8"	761400	C-417-PZK

Filters driers



Size (ODM x ODM)	Part Numbers	Description
3/8"	761500	HPC-103-PZK
1/2"	761501	HPC-104-PZK
3/8"	761600	HPC-163-PZK-HH
1/2"	761601	HPC-164-PZK-HH
5/8"	761602	HPC-165-PZK-HH

Moisture and liquid indicators *Catch-All*



Size (ODM x ODM)	Part Numbers	Description
3/8"	761700	SA-13-PZK
1/2"	761701	SA-14-PZK
5/8"	761702	SA-15-PZK
7/8"	761703	SA-17-PZK

ZoomLock Flame-Free Refrigerant Fittings

Ball Valves



Size (ODM x ODM)	Part Numbers	Description
3/8"	0BV3-PZK	Ball Valve 3/8 Optimised, ODM
1/2"	0BV4-PZK	Ball Valve 1/2 Optimised, ODM
5/8"	0BV5-PZK	Ball Valve 5/8 Optimised, ODM



Solenoid Valves



Size (ODM x ODM)	Part Numbers	Description
1/4"	4603-00	E2S123-PZK-HP LESS COIL
1/4"	4604-00	E3S123-PZK LESS COIL
3/8"	4605-00	E3S133-PZK LESS COIL
3/8"	4606-00	E5S133-PZK-HP LESS COIL
3/8"	4607-00	E6S133-PZK-HP LESS COIL
1/2"	4608-00	E8S143-PZK-HP LESS COIL
7/8"	4609-00	E19S273-PZK-HP LESS COIL



Crimping Tools

Features

- Lightweight design increases productivity
- Short pressing cycle, 5-7 seconds
- Compact design and 350° jaw rotation allows technician to install in tight spaces
- Automatic piston return
- Safety feature that allows crimp cycle to be interrupted
 - Feature allows manual release of piston, if needed
- High-quality, powerful Makita Li-Ion technology for lasting, battery-powered pressing
 - 100-150 Crimps per charge
 - Short charging time of just 15 minutes (2.0 Ah)
 - Makita batteries and chargers available worldwide
- Tool service indicated via imbedded LEDs, illuminates at 10,000 cycles
- Tool Warranty is 24 months from date of purchase



CRIMPS UP TO 1-1/8"



CRIMPS UP TO 1-3/8"

Klauke® 15 kN MODEL MAP2LCER

- Available in Tool Kit:
 - 0 Jaw Tool Kit**
PZK-TK0, P/N 770000-EU,
P/N 770000-GB;
 - Tool kit without battery:**
P/N 770000-NB;
- For use with J Series Jaws
- 8 Jaw Kit & Individual Jaws Sold Separately
- Approved Copper Tubing Types:
 - Hard Copper (Drawn)
 - 1/4" – 1-1/8" Type ACR, M, L
 - Type K only up to 7/8"
 - Soft Copper (Annealed)
 - 1/4" – 7/8" Type ACR, L
 - Type K only up to 7/8"

Klauke® 19 kN MODEL MAP2L19

- Available in Tool Kit:
 - 0 Jaw Tool Kit**
PZK-TK190, P/N 770025-EU,
P/N 770025-GB
 - Tool kit without battery:**
P/N 770025-NB;
- For use with KJ Series Jaws
- 8 Jaw Kit & Individual Jaws Sold Separately
- Approved Copper Tubing Types:
 - Hard Copper (Drawn)
 - 1/4" – 1-3/8" Type ACR, M, L, K
 - Soft Copper (Annealed)
 - 1/4" – 1-3/8" Type ACR, L, K



Tool Kits



0 Jaw Tool Kits

Includes a Klauke crimping tool and the tool kit contents, listed at below right.

- **Description:** PZK-TK
- **Part Number:** 770000- EU, 770000-GB, 770000-NB
- **Includes Crimping Tool:** Klauke 15 kN MAP2LCER

- **Description:** PZK-TK190
- **Part Number:** 770025-EU, 770025-GB, 770025-NB
- **Includes Crimping Tool:** Klauke 19 kN MAP2L19

Jaw Kits



Klauke 8 Jaw Kits

8 piece Klauke 15 kN jaw kit in hard plastic carrying case.

- **Description:** J4-J18 Klauke
- **Part Number:** 770208 J Series
- **Jaw Sizes (Inches):** 1/4, 5/16, 3/8, 1/2, 5/8, 3/4, 7/8, 1-1/8
- **Compatible with Klauke Model:** 15 kN MAP2LCER

8 piece Klauke 19 kN jaw kit in hard plastic carrying case.

- **Description:** KJ4-KJ22 Klauke
- **Part Number:** 770239 KJ Series
- **Jaw Sizes (Inches):** 1/4, 3/8, 1/2, 5/8, 3/4, 7/8, 1-1/8, 1-3/8 (5/16 jaw sold separately)
- **Compatible with Klauke Model:** 19 kN MAP2L19

Klauke Tool Kit Contents

- Klauke Crimping Tool
- Tubing Cutter
- Deburring Tool
- RLS Crimp Gauge
- RLS Depth Gauge
- Stainless Steel Brush
- Abrasive Pad
- Permanent Marker
- Battery Charger
- (2) Lithium-Ion Rechargeable Batteries

Crimping Tools and Jaw Selection

 J Series Jaw	 KJ Series Jaw
 Klauke 15 kN Crimping Tool MAP2LCER	 Klauke 19 kN Crimping Tool MAP2L19

APPROVED COPPER TUBING TYPES

Hard Copper (Drawn)	1/4" – 1-1/8" Type ACR, M, L Type K only up to 7/8"	1/4" – 1-3/8" Type ACR, M, L, K
Soft Copper (Annealed)	1/4" – 1-1/8" Type ACR, L Type K only up to 7/8"	1/4" – 1-3/8" Type ACR, L, K

FEATURES

Crimping Force	15kN	19kN
Minimum Crimp Pressure	425 bar / 6,163 psi	525 bar / 7,613 psi
Number of Crimps	2.0 Ah approx. 150 (for NS20)	
Battery Capacity	18V / 1.5 Ah Li-Ion Makita (BL1820B)	
Charging Time	15 minutes	
Operating Temp. Range	14°F to 104°F (-10°C to 40°C)	
Jaw Holder	Swivels through 350°	
Weight with Battery Without Jaw	1.7 kg (3.7 lb.)	1.8 kg (4.0 lb.)
Including Jaw	2.3 kg (5.1 lb.)	3.1 kg (6.8 lb)
Dimensions	377 x 75 x 116 mm	395 x 80 x 118 mm
Diagnostics PGA 1 Compatible	X	X
i-press Software Compatible	X	X
Tool Warranty	24 months from date of purchase	

TOOL KITS / PART NUMBER

0 JAW TOOL KITS	PZK-TK0 770000-EU, 770000-GB, 770000-NB	PZK-TK190 770025-EU, 770025-GB, 770025-NB
------------------------	---	---

Crimping Tools and Jaw Selection



J Series Jaw



**Klauke 15 kN
Crimping Tool
MAP2LCER**



KJ Series Jaw



**Klauke 19 kN
Crimping Tool
MAP2L19**

JAW KITS / PART NUMBER		
8 PIECE JAW KITS	J4-J18 770208 1/4, 5/16, 3/8, 1/2, 5/8, 3/4, 7/8, 1-1/8	KJ4-KJ22 770239 1/4, 3/8, 1/2, 5/8, 3/4, 7/8, 1-1/8, 1-3/8
JAW CASE (EMPTY)	770240 (8 empty slots)	
INDIVIDUAL JAWS/ PART NUMBER		
1/4"	PZK-J4 770200	PZK-KJ4 770230
5/16"	PZK-J5 770201	PZK-KJ5 770231
3/8"	PZK-J6 770202	PZK-KJ6 770232
1/2"	PZK-J8 770203	PZK-KJ8 770233
5/8"	PZK-J10 770204	PZK-KJ10 770234
3/4"	PZK-J12 770205	PZK-KJ12 770235
7/8"	PZK-J14 770206	PZK-KJ14 770236
1"	—	PZK-KJ16 770241
1-1/8"	PZK-J18 770207	PZK-KJ18 770237
1-3/8"	—	PZK-KJ22 770238

Replacement Parts and Accessories



Tubing Cutter

ZoomLock approved tubing cutter.

- **Description:** 1/4" to 1-1/8" Capacity Tubing Cutter
- **Part Number:** 770006



Deburring Tool

ZoomLock approved deburring tool.

- **Description:** 1/4" to 1-3/8" Capacity Tube Deburring Tool
- **Part Number:** 770007



RLS Crimp Gauge

Confirms the measurement of the finished crimp band diameter.

- **Description:** PZK-GNG1
- **Part Number:** 770005



Standard RLS Depth Gauge

Metal depth gauge confirms the proper insertion depth of the tubing.

- **Description:** PZK-IDGM
- **Part Number:** 770014



Optional Depth Gauge

Plastic depth gauge confirms the proper insertion depth of the tubing.

- **Description:** PZK-IDGP
- **Part Number:** 770015



Diagnostic Tool

Adaptor tool for crimping tool diagnostics. Easily connect to PC via USB-Interface. Provides statistical evaluation of average crimping process of tool. Free downloading of Software "iPress" via www.klauke.com.

- **Description:** PGA1
- **Part Number:** 770008
- **Compatible with:**
Klauke MAP2LCER
Klauke MAP2L19

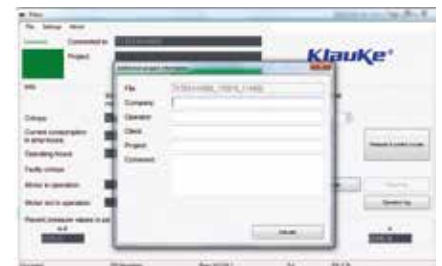

Installation Instructions

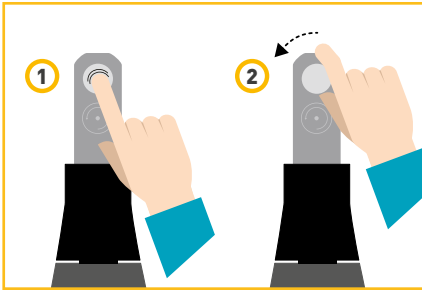

STEP 1

Press the ZoomLock Crimping Tool locking pin, then rotate 45° to release.

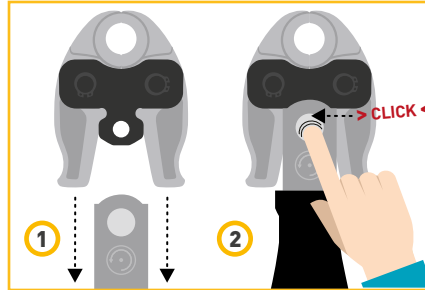

STEP 2

Slide jaws over Crimping Tool head, then depress locking pin until it clicks.



STEP 3

Slide charged battery into base of Crimping Tool. Press and hold the trigger on Crimping Tool to calibrate. **Calibration is recommended daily, prior to use.**

WARNING! COPPER TUBE ENDS SHOULD BE INSPECTED AND ANY SHARP EDGES SHOULD BE ADDRESSED. SHARP EDGES MAY CAUSE DAMAGE TO THE O-RING.

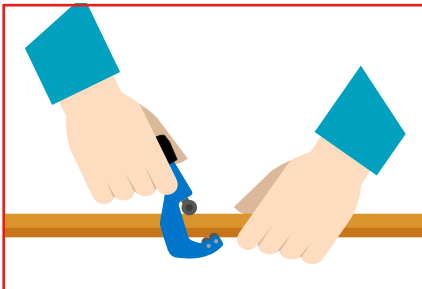

STEP 4 - CUT

Cut copper tube using the **supplied** or similar commercially available tube cutter. Verify tube cutter is properly maintained and wheel is sharp. **DO NOT** use any type of saw as this creates a sharp surface that will cut the o-ring.

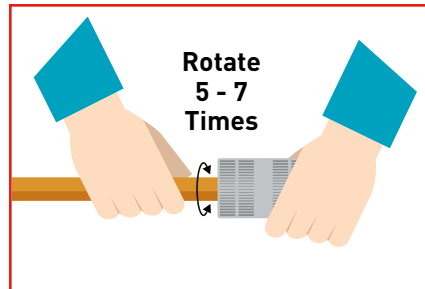

STEP 5 - DEBURR

Use supplied deburring tool. **ALL tubing MUST** have its outer diameter **deburred** prior to ZoomLock fitting installation. Rotate tool back-and-forth 5 - 7 times to remove sharp edges and burrs. **Perform this step BEFORE sanding.**

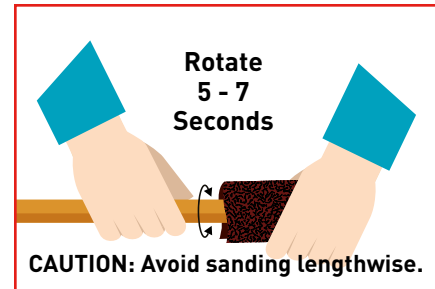

STEP 6 - SAND & CLEAN

ALL tubing must be SANDED and CLEANED. Use provided heavy duty abrasive pad, nylon mesh abrasive pad (maroon color) or 180 grit sandpaper. **SAND tube in RADIAL DIRECTION** as shown with arrows for 5 - 7 seconds or 10 - 14 times back-and-forth. Remove residual debris from tube end.

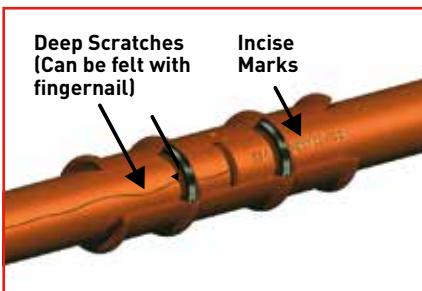

STEP 7 - INSPECT

INSPECT copper tube **AFTER** sanding. Surfaces need to appear clean and shiny. Inspect for any **VISIBLE SCRATCHES, INCISE MARKS OR OTHER TUBE DEFECTS.** Area of importance is within 1.5 inches from tube end. If scratches are present, cut off affected area and repeat Steps 4 -7 or sand thoroughly to remove.

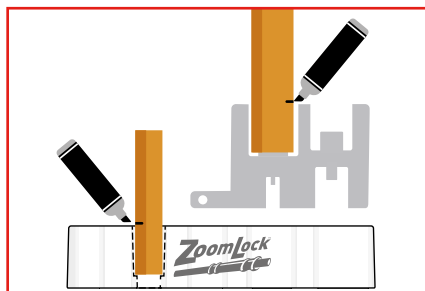

STEP 8 - MARK

Using the depth gauge provided or the chart on page 21 to determine the insertion depth. Mark the tubing with a permanent marker to indicate proper insertion depth on every tube. Two styles of gauges are shown (metal gauge is no longer available).

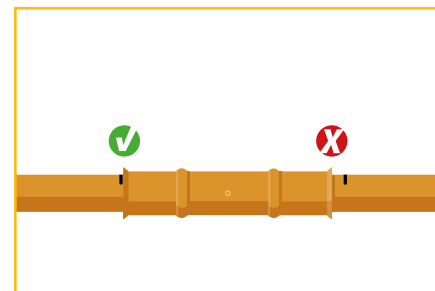

STEP 9

Push the fitting onto the tube. Use the mark to assure insertion depth and secure fit.

Installation Instructions

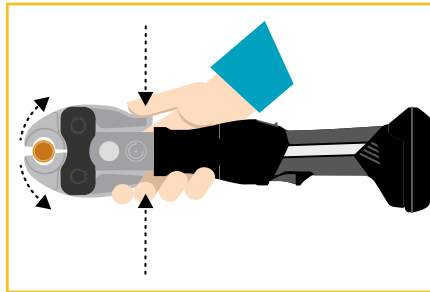

STEP 10

Open the jaws of the ZoomLock Crimping Tool.

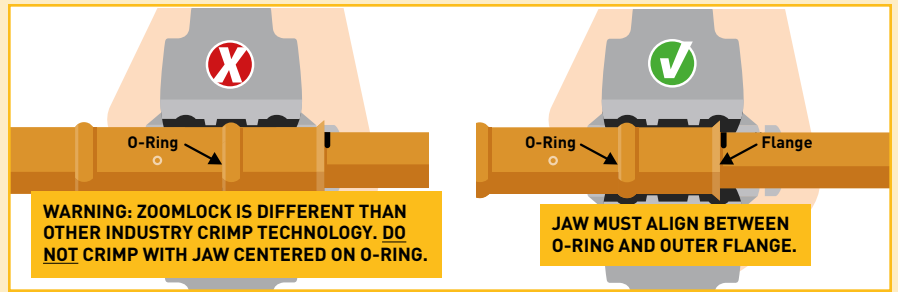

STEP 11

Properly place the crimping jaws onto the fitting. Grooves in the jaws make it easy to align. See illustration at above right for proper crimping alignment.

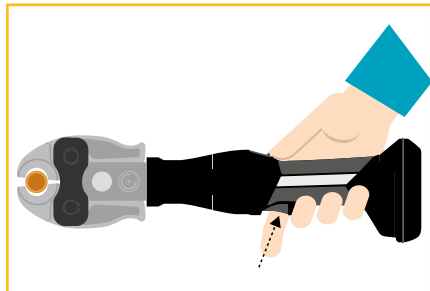

STEP 12

Press and hold the trigger on the ZoomLock Crimping Tool to begin the crimping process. Continue to hold the trigger until the ZoomLock Crimping Tool completes its cycle.

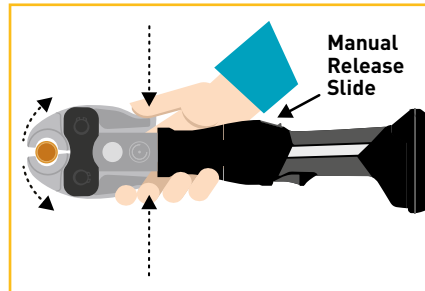

STEP 13

Open the jaws and remove from the fitting. If the jaws do not open, crimping cycle was not completed. For manual override, slide the manual release button down to open the jaw in case of emergency.

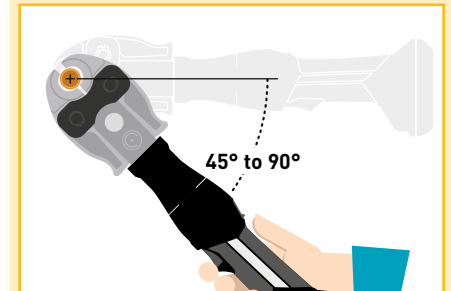

STEP 14

APPLIES TO 1-3/8" FITTINGS ONLY
Crimp 1-3/8" fitting twice, rotate crimping tool 45 to 90 degrees after first crimp and repeat crimp.

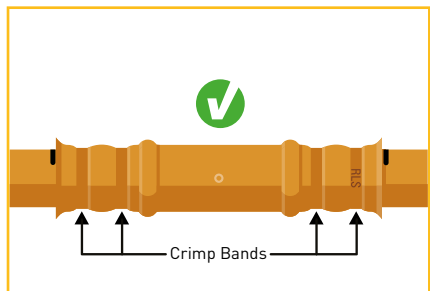

STEP 15

A special "RLS" mark will be displayed on the tube to let you know the connection is crimped properly.

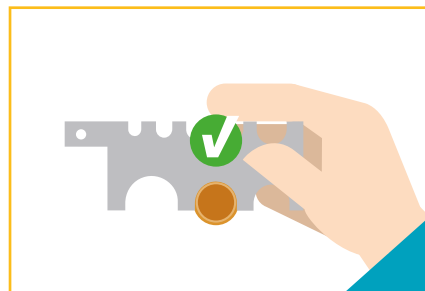

STEP 16

The supplied RLS Crimp Gauge will confirm the measurement of the finished crimp band diameter. See crimp band locations noted in Step 15. It may be necessary to rotate the gauge in order to not interfere with the copper tube flashing left from the crimping process.

WARNING!



FAILURE TO FOLLOW THE INSTALLATION INSTRUCTIONS, IMPROPER SELECTION OR IMPROPER USE OF ZOOMLOCK FITTINGS AND RELATED ACCESSORIES ("PRODUCTS") CAN CAUSE DEATH, PERSONAL INJURY AND PROPERTY DAMAGE.

Troubleshooting and Frequently Asked Questions

Troubleshooting

1. **Do you have any troubleshooting suggestions if a coupling leaks after crimp?**
 - A. Verify tubing for scratches, incise marks and dents prior to tube cutting. Be careful when using a knife to cut off plastic shipping caps on copper tubes.
 - B. Take time to cut the tubing properly using a tubing cutter. Rushing through the cutting process may cause dents and oval tubing which can create leaks.
 - C. Verify proper deburring and sanding/cleaning of tube surface per steps 5 to 7.
 - D. Verify proper tube insertion depth using provided insertion gauge. One gauge is provided with the tool kit or can be ordered separately. Refer to the “minimum insertion depth” table in FAQ section if you do not have a gauge.
 - E. Verify the proper crimp diameter using the provided crimp gauge.
 - F. Verify correct jaw is installed for the fitting you are trying to crimp.
 - G. Try applying a light coating of spray lubricant such as WD-40 directly to the jaws.
 - H. Let jaw and tool do the work. If the fitting is in a hard to reach place, it is important to let the tool body move freely.
 - I. Avoid applying any sort of pulling or twisting of the tool during the crimp process.
 - J. If the fitting was recently crimped (15 – 20 minutes) prior to pressurization, it is possible the bubbles are a result of trapped air in the double crimp area to leak out over time. This is not a joint leak and will leak out over time. This is more likely to occur on smaller fittings.
2. **What can I do if the crimp gauge does not fit?**

You can lubricate the jaws one time with WD-40 (or similar) along with re-crimping. Be sure to rotate the tool a few degrees.
3. **My jaws sometime get stuck on the fitting after crimping. What can I do to make it easier to remove the jaws?**

Applying a thin coating of WD-40 or similar lubricant to the jaws before starting a job should help.
4. **If a fitting does leak, can you braze the fitting in rather than cutting out the fitting and having to make up for lost pipe?**

If you find a fitting that has a refrigerant leak, try re-crimping the connection first. If that does not work, the fitting must be cut out and replaced. Trying to braze the fitting will very likely melt the o-ring material and thus introduce contaminants into the system that could cause other system issues.

Installation

5. **Why is it significant that Zoomlock is “UL Listed”?**

UL Listed provides approval by UL for **field and factory installation**. UL **Recognized** products limit products to being **factory installations only** (not field).
6. **What is the #1 suggestion to ensure safety?**

For your and your co-worker's protection, it is very important to use the depth and crimp gauges. You are not done installing Zoomlock fittings until you complete step 16. Jaws wear and have a 10,000 to 12,000 estimated life. Just like any mechanical device, tools can malfunction.
7. **What is the #1 cause of leaky fittings?**

Skipping the installation instructions 4 to 8 will cause the tube to leak. It is very important to use the scouring pad and deburr tool. Refrigerant gas at the maximum rated 48 bar pressure is more likely to leak than water at a much lower pressure, therefore, following the tube preparation instructions is very important.
8. **What is considered a “deep” scratch and what can be done to clean this?**

A deep scratch is defined as one that can be felt with your fingernail. Try using a new piece of Scotch Brite® abrasive pad sandpaper. Alternatively, 180 grit sandpaper/cloth can be used for 15 - 20 seconds to remove a deep scratch.



Following tube preparation steps 4 to 8 is important for preventing leaks.

9. **Can you show an example of a “good” copper tube surface after sanding?**



Figure 1 - Copper tube with “good” surface.



Figure 2 - Copper tube with “bad” surface scratch.

Troubleshooting and Frequently Asked Questions

Figure 1 below shows an example of a good tube. Figure 2 is an example of a tube with a bad scratch that requires proper tube preparation. It is very important to follow deburring, sanding and inspection steps 4 to 8.

10. How do I know the correct insertion depth when pushing the ZoomLock fitting onto the copper tube?

Use the depth gauge provided or the Minimum Insertion Depth chart below to determine the correct insertion depth. Mark the tubing with a permanent marker to indicate proper insertion depth on every tube.

MINIMUM INSERTION DEPTH		
Fitting Size	Inches	mm
1/4	1	24
5/16	1	24
3/8	1	24
1/2	1-1/4	32
5/8	1-1/4	32
3/4	1-1/4	32
7/8	1-1/4	32
1	1-1/4	32
1-1/8	1-1/4	32
1-3/8	1-1/2	38

11. How do you slide insulation over these fittings (the flare will grab insulation).

If the flare of the fitting tends to be a problem, you can smooth the transition over the fitting by adding duct tape around the flared edge of the fitting to the tube.

12. Do you have a solution for crimping onto flared tubing like that coming out of the condenser and evaporator on residential units?

No, we do not have a specific product designed to crimp over the flared tubing. However, if there is at least 2 inches (51 mm) of straight copper tubing after the flared end and is accessible with the jaws, we suggest that you cut the flared end off and crimp directly to the tube.

13. How much tolerance can the ZoomLock fitting handle on the pipe being crimped?

We know that not all copper tubing is the same, but we have tested ZoomLock with most copper tube manufacturers with no issues. The tolerance for each tube to ensure a leak-free joint is defined by ASTM B280 and/or EN 12735.

14. What is the minimum brazing distance?

MINIMUM DISTANCE FROM ZOOMLOCK FITTING TO BRAZE

Tube Diameter	Inches	Millimeters
1/4 to 1/2	5	127
5/8	7	178
3/4	8	203
7/8	9	229
1	9	229
1-1/8	11	279
1-3/8	14	356

15. What is the minimum distance between ZoomLock fittings?

The ends of the fittings should be no closer than 1/4 inch (7mm) apart.

16. What is the recommended minimum space (envelope) needed around the Klauke tool and jaws to crimp?

The envelope of 11" x 7" (280 mm x 180 mm) is recommended around fittings. The illustration below shows closed space around the fitting with one end open. It assumes a 4" (110 mm) centerline between fittings and a max 1-3/8" (35 mm) couplings. A minimum of 2.25" (58 mm) from the back wall surface is required. You need 2-1/2" (64 mm) between couplings for jaws if the tool is coming up from below the fittings to crimp. We realize there are many configurations, so please contact your local Parker sales engineer with any questions.

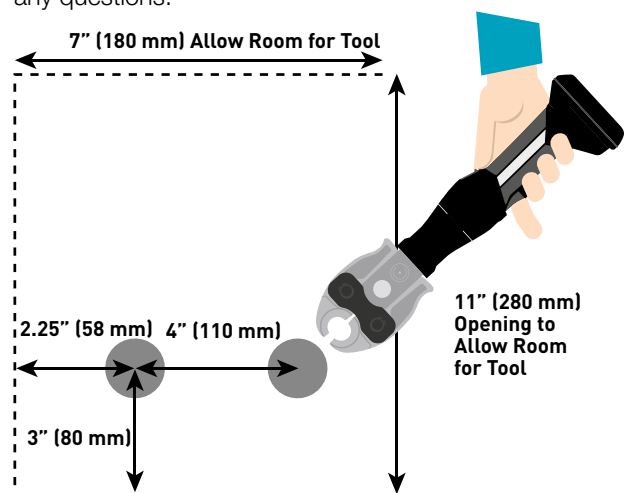

17. What can I use to make inserting larger copper tubes into the Zoomlock fittings easier?

Larger size tubing such 1-1/8" (28,6 mm) or 1-3/8" (35 mm) can be more difficult to slide into the fitting since there is large surface area. Any of the following lubricants can be used to aid in the tube insertion: Parker O-Lube, Nylog Blue or POE oil.

Troubleshooting and Frequently Asked Questions

Crimp Tool

18. Can Zoomlock be crimped in the same location as Viega ProPress fittings?

No. The fittings will leak if you do not crimp per step 11 of the installation instructions. Proper crimping is also illustrated in the photo below.



19. How many crimps can you complete on a complete battery charge?

On average you can achieve 100-150 crimps per charge depending on the size fittings being crimped. Each Klauke Tool kit comes with 2 Makita Lithium-ion 2.0 Ah 18V batteries (BL1820B) and a rapid charge charging system. To prevent any downtime, it is recommended that you have both batteries charged before going to the job site and to have one charging while the other is in use.

20. How can I increase the number of crimps and battery life?

You can purchase a Makita 3.0 Ah 18 V Li-Ion battery (BL1930). Parker does not sell these, but they can be purchased at your local or online retailers wherever batteries are sold.

21. How do you know when the tool needs to be serviced?

The 15 kN (MAP2L) and 19 kN MAP2L19 Klauke tools have red LED lights on the back of the tool that will blink for 20 seconds after a crimp. The 19 kN MAP219 tool has a screen on the tool which indicates the number of remaining crimps. Take the tool back to an authorized dealer to have the tool serviced.

22. What is the expected life of the jaws?

Each jaw has an expected life of 10,000 to 12,000 crimps. Klauke jaws are designed to safely crack at their end of life, so you should keep track of your approximate usage. The casting itself on the Klauke jaw is designed to crack at end of life.

23. How do you know when the jaw needs to be replaced?

You will know when the jaw needs to be replaced when the contact point between the upper and lower jaw

starts to open up/widen. A good indication of failure is when the crimp gauge no longer engages. Use the supplied wire brush in tool kit to periodically clean pressing jaws.

24. Where can replacement batteries and chargers be purchased?

The 2.0 Ah 18 V Makita Li-Ion battery (BL1820B) along with the 110V AC charger (DC18RC) can be purchased at your local or online retailers wherever batteries are sold.

Technical

25. What material is the o-ring made of?

The o-ring is a highly engineered HNBR Parker o-ring that has been used in HVAC applications by OEMs and suppliers for many years with no issues.

26. What is the expected life of the o-ring in the system?

The expected life of the o-ring that stays within the product specifications for temperature and pressure should be 30 years.

27. Does the o-ring compensate for imperfections in the piping to make a tight seal?

Yes, the o-ring does compensate for small/minor scratches on the surface of the tube; however, the tubing needs to be inspected prior to use per ASTM B280 and the Copper Tube Handbook published by the Copper Development Association (CDA) specifications. Imperfections in and adjacent to the crimp area could inhibit the joint integrity. These imperfections may include surface scratches, incise marks, and tubing out of round.

28. Are there any shelf life concerns?

No, the shelf life of the product is estimated at or above 30 years.

29. Is there a concern about ice building up and then thawing under fitting in a horizontal or vertical configuration?

No, ZoomLock has been thoroughly tested in freeze/thaw applications with over 10,000 cycles completed in both vertical and horizontal configurations with no leakage concerns.

30. Are there any concerns with corrosion due to coastal applications, cleaning agents, or off-gassing of produce/vegetables?

No, ZoomLock has gone through a battery of corrosion testing, completing over 2,000 hours of salt spray testing without failure, which proves the resilience of the product.

Troubleshooting and Frequently Asked Questions

31. The product specifications state that the application temperature limits are -40°F to +300°F / -40°C to 150°C. What happens if we go beyond that limit?

If the application that the fitting is being used in goes beyond the specified limits of the o-ring (-40°F to +300°F / -40°C to 150°C) then there will be an increased likelihood that a leak can occur.

32. Can I use ZoomLock in a transportation application where fitting vibration is high?

Yes, ZoomLock has gone through extensive vibration testing and results are actually better than that of a braze joint. Please review the vibration testing procedure and conclusion for more information.

33. Can you use ZoomLock to crimp to aluminum, steel, or stainless steel?

No, ZoomLock is specifically designed for copper to copper connections. Connecting to dissimilar metals can cause formicary corrosion issues that could cause a failure.

34. Is it OK if ZoomLock fittings rotate?

Yes, but only if the crimps were checked with the supplied crimp gauge. Since Zoomlock fittings are crimped concentrically with the tube, approximately 5 to 10 degrees of rotation can be observed depending on the copper tube tolerances. However, one should not purposely try rotating the joint since there is a risk of damaging the o-ring. The burst strength of the joint (>2,100 psi) is still good and will not leak.

Other

35. Is ZoomLock approved by state and city building codes?

ZoomLock has been approved by UL-207, ASHRAE 15, International Code Council – Evaluation Service (ICC-ES), International Mechanical Code (IMC), Universal Mechanical Code (UMC), and International Residential Code (IRC). These approvals are all that is needed in most areas. Please contact your local building inspector with questions prior to install.

36. Can systems with ZoomLock fittings be retrofitted with lower GWP refrigerants?

Yes, but refer to the table below for guidance. Your system must be using one of the higher GWP refrigerants listed in the “baseline” section. Your lower GWP refrigerant options are listed in the “retrofit refrigerants” section.

Baseline Refrigerants	Retrofit Refrigerants
Can be replaced with ▶	
■ R134a	■ R407A/C/F/H
■ R404A	■ R448A
■ R422A/D	■ R449A/B
■ R424A	■ R450A
■ R507A	■ R452A
	■ R513A/B
	■ R1234yf
	■ R1234ze(E)



Performance Data

ACR Pressure Drop (10 ft. long)

3/8" ACR Tube Pressure Drop vs. Velocity

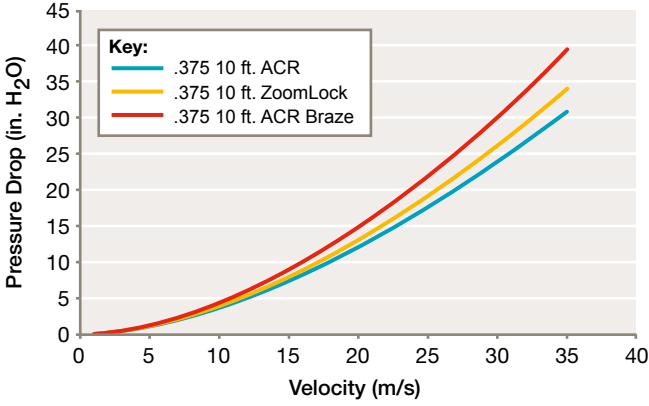

ACR Loss Coefficient

3/8" ACR Tube Loss Coefficient vs. Reynolds Number

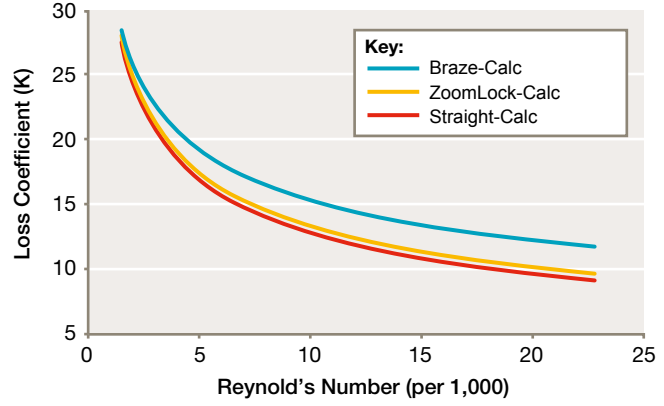

3/4" ACR Tube Pressure Drop vs. Velocity

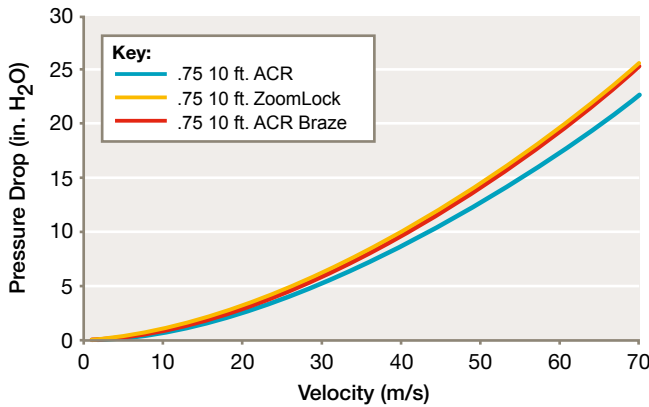

3/4" ACR Tube Loss Coefficient vs. Reynolds Number

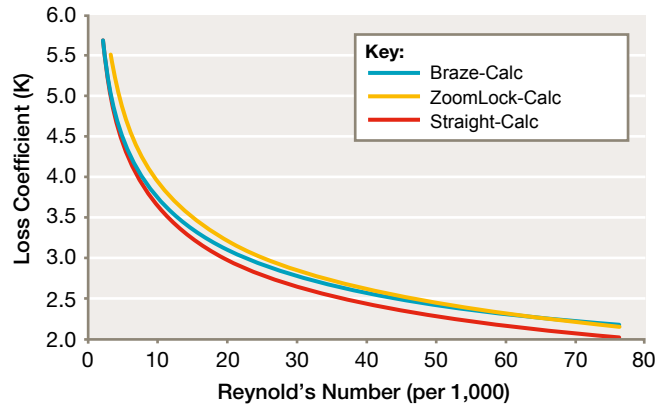

7/8" ACR Tube Pressure Drop vs. Velocity

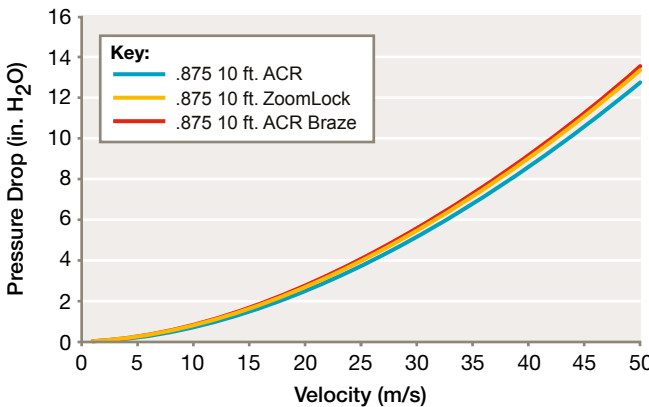

7/8" ACR Tube Loss Coefficient vs. Reynolds Number

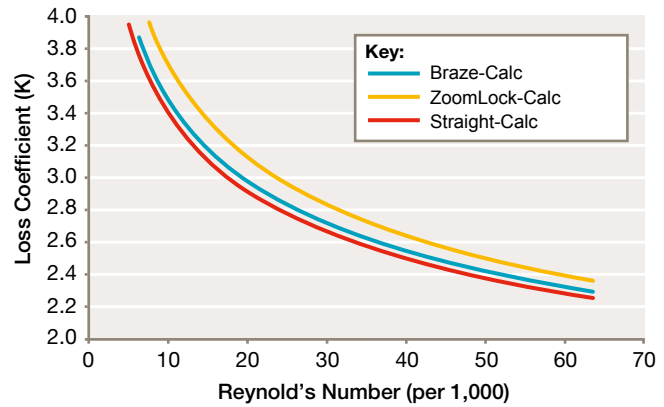

ICC-ES Evaluation Report



Effective Date: January 2018

Revision Date: December 18, 2017

This report subject to renewal in January 2019.

PMG-1296

CSI: DIVISION: 23 00 00—HEATING, VENTILATING AND AIR CONDITIONING (HVAC)
Section: 23 20 00—HVAC Pipe and Fittings

Product certification system:

The ICC-ES product certification system includes testing samples taken from the market or supplier's stock, or a combination of both, to verify compliance with applicable codes and standards. The system also involves factory inspections, and assessment and surveillance of the supplier's quality system.

Products: Refrigeration Tubing Connectors

Listee: RLS, LLC
101 S. Douglas Street
Shelbina, MO 63468
www.rlspressfittings.com

Additional Listee:

Parker Sporlan
206 Lange Drive
Washington, MO 63090
www.parker.com

Compliance with the following codes:

2018, 2015, 2012, 2009 and 2006 *International Mechanical Code*® (IMC)
2018, 2015, 2012, 2009 and 2006 *International Residential Code*® (IRC)
2015, 2012, 2009 and 2006 *Uniform Mechanical Code*® (UMC)*

**Copyrighted publication of the International Association of Plumbing and Mechanical Officials.*

Compliance with the following standards:

UL 207 (Edition 8), Standard for Refrigerant-Containing Components and Accessories, Nonelectrical

Identification:

The refrigerant tubing connectors shall be legibly and permanently marked with the manufacturer's name, trade name, trademark, or identifying symbol or other descriptive marking by which the organization responsible for the product may be identified.

The shipping carton, a separate instruction sheet included with the shipping carton or a tag attached to the component shall include a distinctive model, part number, or type designation for the connector and include information for each refrigerant type for which the connector is intended and the ICC-ES PMG listing mark.

Installation:

The refrigerant tubing connectors must be installed in accordance with the manufacturer's published installation instructions, the applicable codes and this listing.

Mechanical joints shall not be used on annealed temper copper tube in sizes larger than 7/8-inch (22.2 mm) OD size per IMC and 3/4" of an inch nominal size per UMC.

Note: The 2018 IMC and IRC permit for press-connect joints listed for refrigeration piping.

Models:

The refrigerant tubing connectors are intended for connection of copper, aluminum, titanium and other types of tubing approved by the manufacturer. The connection is accomplished by compressing (solder-free) the fitting to a pipe. The refrigerant connectors are only suitable with the following refrigerants (R32, R134A, R143A, R290, R404A, R407, R410A, R417A, R421A, R422, R424A, R427A, R434A, R437A, R433A, R445A, R446A, R447A, R448A, R449, R450A, R451, R452, R453A, R454, R455A, R456A, R507, R513, R600, R600a, R718, R1234yf, R1234ze, Ethylene Glycol).

ICC-ES Evaluation Report

Serial Model Name: RLS™ Cu

Type of Connector	Sizes (Inches)
Couplings	1/4, 5/16, 3/8, 1/2, 5/8, 3/4, 7/8, 1, 1-1/8, 1-1/4, 1-3/8
Slip Couplings	1/4, 5/16, 3/8, 1/2, 5/8, 3/4, 7/8, 1-1/8, 1-3/8
Long Radius 90°	1/4, 5/16, 3/8, 1/2, 5/8, 3/4, 7/8, 1, 1-1/8, 1-1/4, 1-3/8
Long Radius 45°	1/4, 5/16, 3/8, 1/2, 5/8, 3/4, 7/8, 1-1/8, 1-3/8
Street 90°	1/4, 3/8, 1/2, 5/8, 3/4, 7/8, 1-1/8, 1-3/8
Stubs	1/4, 5/16, 3/8, 1/2, 5/8, 3/4, 7/8, 1-1/8, 1-3/8
Reducers (F x F)	1-3/8 x 1-1/8, 1-3/8 x 7/8, 1-1/8 x 7/8, 1-1/8 x 3/4, 1-1/8 x 5/8, 1-1/8 x 1/2, 1 x 7/8, 7/8 x 3/4, 7/8 x 5/8, 7/8 x 1/2, 3/4 x 5/8, 3/4 x 1/2, 5/8 x 1/2, 5/8 x 3/8, 5/8 x 1/4, 1/2 x 3/8, 1/2 x 1/4, 3/8 x 1/4, 5/16 x 1/4, 11mm x 3/8
Tees	1/4, 5/16, 3/8, 1/2, 5/8, 3/4, 7/8, 1, 1-1/8, 1-1/4, 1-3/8
Bushing (B x F)	1-3/8 x 1-1/8, 1-1/8 x 7/8, 7/8 x 3/4, 3/4 x 1/2, 5/8 x 1/2, 1/2 x 3/8
Cap	1/4, 5/16, 3/8, 1/2, 5/8, 3/4, 7/8, 1, 1-1/8, 1-1/4, 1-3/8
SAE (Euro) Flare	1/4, 3/8, 1/2, 5/8, 3/4
Capillary Coupling	0.072 x 1/4, 0.109 x 1/4
Return Bend	1/4, 5/16, 3/8, 1/2, 5/8, 3/4, 7/8, 1-1/8

Ratings:

Sizes	Design Pressure, psig	Maximum Abnormal Pressure, psi	Continuous Operating Temperature
1/4" RLS	700	700	250°F (121°C)
5/16" RLS	700	700	250°F (121°C)
3/8" RLS	700	700	250°F (121°C)
1/2" RLS	700	700	250°F (121°C)
3/4" RLS	700	700	250°F (121°C)
5/8" RLS	700	700	250°F (121°C)
7/8" RLS	700	700	250°F (121°C)
1-1/8" RLS	700	700	250°F (121°C)
1-3/8" RLS	700	700	250°F (121°C)

Conditions of Listing:

- The refrigerant tubing connectors must be used with only the following refrigerants (R32, R134A, R143A, R290, R404A, R407, R410A, R417A, R421A, R422, R424A, R427A, R434A, R437A, R433A, R445A, R446A, R447A, R448A, R449, R450A, R451, R452, R453A, R454, R455A, R456A, R507, R513, R600, R600a, R718, R1234yf, R1234ze, Ethylene Glycol).
- Mechanical joints shall not be used on annealed temper copper tube in sizes larger than 7/8 inch (22.2 mm) OD size per IMC and 3/4 of an inch nominal size per UMC.
- The installation must be pressure-tested for leaks in the presence of the code official or the code official's designated representative.
- When installation is in fire-resistance-rated assemblies, evidence must be provided to the code official of compliance with *International Building Code*® (IBC) Section 713 (penetrations), *Uniform Building Code* (UBC) Section 709 (walls and partitions) or UBC Section 710 (floor/ceiling or roof/ceiling), as applicable.
- The connectors must not be used as a source of electrical ground.
- When the system is embedded in concrete, tubing must be covered a minimum of 3/4 inch (19.1 mm) and installation must comply with IBC Section 1906.3 or UBC Section 1906.3, as applicable.

Helium Leak Test Report



1250 Arthur E Adams Dr., Columbus, OH 43221

LAB SERVICES

Helium Leak Test Report

page 1 of 2

Customer: Marmon Refrigeration Technologies

Project No.: 12866CSL-01

Equipment: Veeco MS-40

Date Reported: January 10, 2013

Project Engineer: Jim Busch

Principal Tech: Barb Christel

Scope: To test and report the leak rate of RLS press connections.

Background: Marmon Refrigeration Technologies (MRT) submitted RLS™ press connection samples for helium leak testing. Six (6) different RLS™ sizes were chosen to connect commercially available ACR tubing (see Table 1). Thirty (30) union connections were chosen as a sample lot with two (2) connections per fitting. Each sample connected two pieces of tubing approximately nine (9) inches long. One of the tubes was brazed shut at one end and the other tube was reduced to a ¼" tube stub.

Table 1. Tube Diameters Tested

Tube O.D. (in)	# of Samples	Total # of Tested Connections	Notes
0.250	30	60	Samples were made from commercially available ACR tubing (soft)
0.313	30	60	
0.375	30	60	
0.750	30	60	
0.875	30	60	
1.125	30	60	

EWI Leak Testing Approach: Prior to testing each lot of samples, the Veeco MS-40 helium leak tester was calibrated. After calibration, a solid ¼" dowel was tested to verify the integrity of the seals on the helium leak test fixture.

The ¼" tube stub was wiped down with methanol and connected to the leak detector via a Swagelok ¼" Ultra-Torr vacuum fitting (see Figure 1). Each sample was pumped down to a level of approximately 500 millitorr prior to applying helium gas near the RLS™ crimp joint (at atmospheric pressure). The helium leak rate was measured and recorded for each of the sixty (60) connections in a thirty (30) piece sample lot.

Helium Leak Test Report



1250 Arthur E Adams Dr., Columbus, OH 43221

LAB SERVICES

Helium Leak Test Report

page 2 of 2

Customer: Marmon Refrigeration Technologies

Project No.: 12866CSL-01

Equipment: Veeco MS-40

Date Reported: January 10, 2013

Project Engineer: Jim Busch

Principal Tech: Barb Christel



Figure 1. Test Set-up

Results: The maximum leak rate of all connections is summarized in Table 2. The maximum leak rate detected was 5.40E-09 std.cc/sec.

Table 2. Maximum Leak Rate per Lot

Tube O.D. (in)	Maximum Helium Leak std.cc/sec
0.250	4.00E-10
0.313	6.10E-10
0.375	1.30E-09
0.750	5.20E-09
0.875	5.40E-09
1.125	3.00E-10

Reported by: Brad NagySignature: Brad NagyTitle: Manager, Weld & Test Labs

Time and Motion Study

Conducted by:

Jay Peters, Principal Advisor, Codes and Standards International

Methodology

A time study was conducted in a controlled environment, with two stations set up for joining refrigeration tube: one by brazing and one by using ZoomLock flame-free fittings. Two different installers were used, one very experienced in making brazed connections and one very experienced in using the ZoomLock press tool.

The two installers were timed independently making connections using various sized copper tube and fittings. Before timing began, tube was cut to length and the ends were prepared for connection (as these procedures are the same for both connection methods). Three connections were timed for each size of tube/fitting for each installer, and the three times were averaged. The results are shown in the table below.

LABOR TIME FOR INSTALLING A COPPER COUPLING

Fitting Size	1/4"	5/8"	1-1/8"
Brazed Connection	35 seconds	42 seconds	1:15 minutes
ZoomLock Braze-Free Fitting	24 seconds	24 seconds	25 seconds
% Time Savings	31%	43%	77%

Key Findings and Conclusions

The time savings achieved while joining tube using ZoomLock flame-free fittings, compared to brazed connections, ranged from 31% on the smallest fittings timed to 77% on the largest. The average time savings over the fitting sizes timed was approximately 50%. So, on average, ZoomLock flame-free fittings were made in roughly half the time of brazing — and in less than one-quarter the time on the largest fitting size.

Based on the study, brazed connections take longer to complete than ZoomLock flame-free fittings. When analyzing the installation techniques for both connections, a brazed connection requires a period of time to raise the temperature of the fitting and tube to about 1000°F (538°C). As the tubing and fitting increases in diameter, the amount of time it takes to heat them also increases. The ZoomLock flame-free fittings only require the connection of a press connect tool, which takes less than ten seconds to complete the actual pressing operation (two crimps) — and the time to connect does not increase significantly as the diameter of tubing and fittings increase in size.

In a controlled environment, such as the work station where the time study was conducted, the brazing operation takes less time than a similar joint made on a construction or repair project in the field. The controlled environment is already set up for brazing, with all necessary equipment and materials close at hand. However, using the ZoomLock press tool and fittings require approximately the same amount of time in any environment. Therefore, it can be assumed that the ZoomLock time savings would be even greater outside of a controlled environment.



Parker Worldwide

United Arab Emirates Middle East

Sarkis OHANNESSIAN
Tel +961 3334622
sohannessian@parker.com

Germany, Austria and German speaking part of Switzerland

Francesco GALANTE
Tel +49 (0)175 5756 032
francesco.galante@parker.com

Spain and Portugal

Alberto PEÑA
Tel +34 609 153 154
alberto.pena@parker.com

France, Belgium, French speaking part of Switzerland

Goska WARNECK
Tel + 33 (0)6 73 89 36 08
gwarneck@parker.com

Italy, Greece, Malta, Cyprus Italian speaking part of Switzerland

Andrea BRAGA
Tel +39 334 6944386
abraga@parker.com

Baltic Countries, Eastern and Central Europe, Africa

Eliane EMERIT-BONNOT
Tel +33 (0)6 73 89 36 01
ebonnot@parker.com

Turkey

parker.turkey@parker.com

UK, Northern Europe

Kenny ADAMSON
Tel +44 (0)77853 71229
kadamson@parker.com

Customer Service:

Parker Hannifin Ltd

*Instrumentation Group
Refrigeration and
Air Conditioning Europe*
Manvers House
Office 21
Pioneer Close
Wath Upon Dearne
Rotherham S63 7JZ
United Kingdom
Tel +44 (0) 1709 774600
Fax +44 (0) 1709 774601
racecustomerservice@parker.com
www.parker.com/race



Your local authorized Parker distributor

