

Product Features



Notes: Please refer to installation instructions. Installation instructions are available at www.thermador.com. Specifications are correct at the time of printing. Thermador reserves the right to change product specifications and design at any time, without notice.

1 800 735 4328 | WWW.THERMADOR.COM | 1901 Main Street, Suite 600 Irvine, CA 92614

©2020 BSH HOME APPLIANCES CORPORATION, ALL RIGHTS RESERVED LITHO DATE: 02/2020

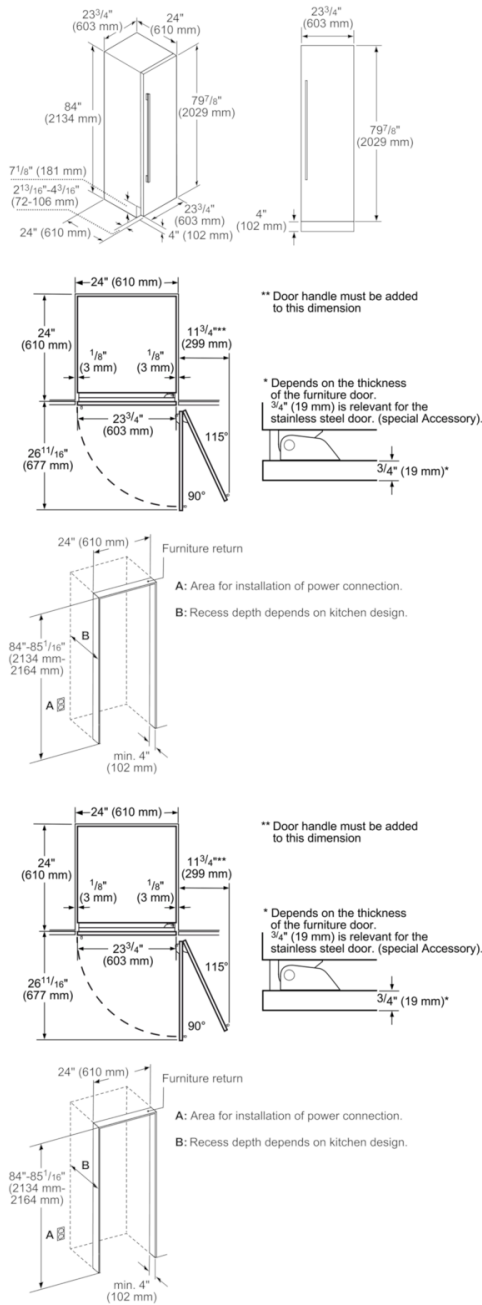

Product Features

Multi-Flow Air Tower	Yes
SUPERCOOL	Yes
SUPERFREEZE	No
Carbon Air Filter	No
Temperature Controlled Drawer	No
Humidity Control Drawer	No
Number of Door Bins - Refrigerator	3
Adjustable Door Bins - Refrigerator	No
Tilt-Out Door Bins - Refrigerator	No
Gallon Storage Bins	1
No. of shelves in fridge	4
Door Hinge	Right reversible
Adjustable Shelves - Refrigerator	3
Reversible Door Hinge	Yes
Adjustable Shelves - Freezer	No

Technical Specification

UPC code	825225962359
Variant color	Not applicable
Panel ready	Not possible
Silence level (dBA)	40
Watts (W)	350
Current (A)	10
Volts (V)	110-120
Frequency (Hz)	50-60
Total annual energy consumption (kWh)	263.9
Energy Star® qualified	No
Approval certificates	CSA
Power Cord Length	118"
Required cutout size (HxWxD) (in)	84" x 24" x 24 3/4"
Appliance Width (in)	23 3/4"
Height (in)	83 3/4"
Depth (in)	24"
Total unit gross capacity (cu. ft.) - AHAM	13.0
Product packaging dimensions (HxWxD) (in)	88.97 x 29.52 x 30.51
Refrigerator Gross capacity (cu. ft.)	13.0
Net weight (lbs)	311
Gross weight (lbs)	333
SKU	T24IR902SP

Notes: Please refer to installation instructions. Installation instructions are available at www.thermador.com. Specifications are correct at the time of printing. Thermador reserves the right to change product specifications and design at any time, without notice.

1 800 735 4328 | WWW.THERMADOR.COM | 1901 Main Street, Suite 600 Irvine, CA 92614

©2020 BSH HOME APPLIANCES CORPORATION, ALL RIGHTS RESERVED LITHO DATE: 02/2020