

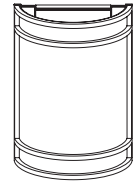

INSTALLATION INSTRUCTIONS INSTRUCCIONES DE INSTALACIÓN



CAUTION: Turn off the main power at the circuit breaker before installing the fixture, in order to prevent possible shock.

PRECAUCIÓN: Para evitar riesgos de descarga eléctrica, corte la alimentación eléctrica en el disyuntor antes de instalar la lámpara.

GENERAL: All electrical connections must be in accordance with local and National Electrical Code (N.E.C.) standards. If you are unfamiliar with proper electrical wiring connections obtain the services of a qualified electrician.

NORMA GENERAL: Todas las conexiones eléctricas deben cumplir todas las normas y reglamentos electrotécnicos vigentes a nivel nacional y local. Si desconoce cómo realizar conexiones eléctricas correctamente, acuda a un electricista calificado.

FCC Notice:

This device has been tested and found to comply with the limits for a Class B digital device, pursuant to part 15 of the FCC Rules. These limits are designed to provide reasonable protection against harmful interference in a residential installation. This equipment generates, uses and can radiate radio frequency energy and, if not installed and used in accordance with the instruction manual, may cause harmful interference to radio communications. However, there is no guarantee that interference can be determined by turning the equipment off and on, the user is encouraged to try to correct the interface by one or more of the following measures:

- Reorient or relocate the receiving antenna.
- Increase the separation between the device and receiver.
- Connect the equipment into an outlet on a circuit different from that to which the receiver is connected.
- Consult the dealer or an experienced radio/TV technician for help.

Aviso de la FCC:

Este dispositivo ha superado satisfactoriamente las pruebas de verificación de los límites establecidos para dispositivos digitales de Clase B en el apartado 15 de las Reglas de la FCC (Comisión Federal de Comunicaciones de EE. UU.). Dichos límites proporcionan una protección razonable contra interferencias electromagnéticas en instalaciones residenciales. Este equipo genera, utiliza y puede irradiar energía de radiofrecuencias y, si no se instala y utiliza según se indica en el manual de instrucciones, puede producir interferencias en sistemas de comunicaciones que también utilicen radiofrecuencias. Al no existir ninguna garantía de que el origen de las interferencias se pueda determinar apagando y volviendo a encender el equipo, se recomienda al usuario que intente corregirlas adoptando una o varias de las siguientes medidas:

- Reorientar o reubicar la antena receptora.
- Aumentar la distancia entre el dispositivo y el receptor.
- Conectar el equipo a una toma de corriente perteneciente a un circuito distinto del receptor.
- Consultar al distribuidor o a un técnico de radio o TV experimentado.

Conforms to standard CAN-ICES 005(B) /NMB-005 (B)

Cumple el estándar CAN-ICES 005(B) /NMB-005 (B)

MODEL/MODELO	Key code/Clave	Dimension/Dimensiones	Input/Alimentación eléctrica	Wattage/Potencia
FLWL120LED30BN	9211701	W:7" * E:3-1/4" * H: 10" / Ancho: 17,78 cm (7") * Saliente: 8,255 cm (3-1/4") * Alto: 25,4 cm (10")	120V 60Hz / 120 V a 60 Hz	10W

TOOLS REQUIRED / HERRAMIENTAS NECESARIAS:

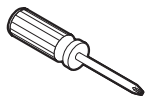

Phillips head screwdriver
Destornillador Phillips



Ladder
Escalera

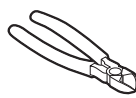

Wire Cutter
Pelacables



Safety Goggles
Gafas protectoras

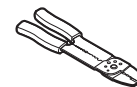

Wire Stripper
Pelacables



Electrical Tape
Cinta eléctrica

1. Carefully unpack the fixture; lay out all parts on a clean surface.
Desembale cuidadosamente la lámpara y coloque todas las piezas sobre una superficie limpia.
2. Fasten the mounting bracket onto the outlet box by using 2 outlet box screws provided.
Fije el soporte de montaje al cajetín de toma de corriente mediante los 2 tornillos incluidos.

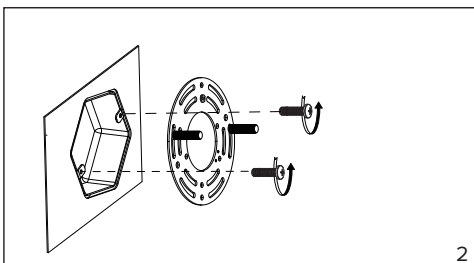

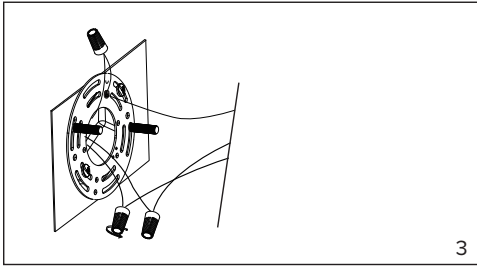

3. Tie ground wire from outlet box and from fixture to the ground screw on the mounting bracket. connect white wire from fixture to white wire (neutral wire) from supply circuit. connect black wire from fixture to black wire (live wire) from supply circuit. cover connections using provided wire connectors.
Conecte el cable de tierra del cajetín y el de la lámpara al tornillo de tierra del soporte. Conecte el cable blanco de la lámpara al cable blanco (neutro) de la alimentación eléctrica. Conecte el cable negro de la lámpara al cable negro (fase) de la alimentación eléctrica. Tape las conexiones con las clemas incluidas.

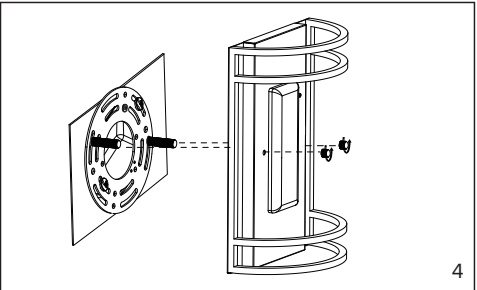

4. Place the wall plate of fixture body over the mounting screws, and secure them by using 2 lock nuts.
Coloque el cuerpo de la lámpara haciendo coincidir los orificios con los tornillos de montaje y fije estos con 2 arandelas y 2 tuercas autoblocantes.

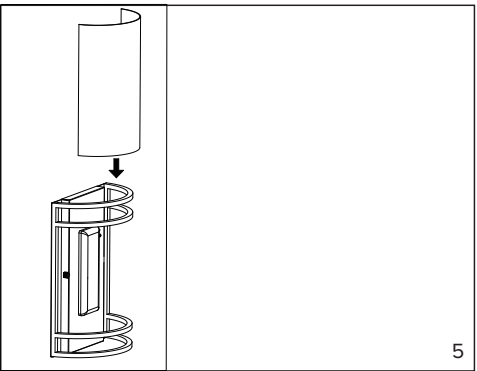

5. Place acrylic shade on the fixture frame from top to bottom.
Coloque la pantalla acrílica en el marco de la lámpara, introduciéndola por arriba.

LIMITED WARRANTY FOR DLC or ENERGY STAR CERTIFICATED PRODUCTS

Subject to the exclusions set forth below, Ferguson Enterprises, LLC (the "Company") warrants its DLC certified indoor light emitting diode (LED) fixtures, including the LED arrays ("DLC Product(s)") to be free from defect in material and workmanship (the "General Warranty") for a period of five (5) years from the date of shipment from the factory. The LED arrays in the DLC Product(s) will be considered defective in material or workmanship only if a total of 20% or more of the individual light emitting diodes in the LED Product(s) fail to illuminate. Ballasts, LED drivers, integral control devices, lamps, emergency batteries and poles are excluded from the General Warranty.

Subject to the exclusions set forth below, the Company warrants its Energy Star certified indoor light emitting diode (LED) fixtures incorporating non-replaceable drivers, including the LED arrays ("ES1 Product(s)") to be free from defect in material and workmanship (the "General Warranty") for a period of five (5) years from the date of shipment from the factory, and the Company warrants its Energy Star certified indoor Integrated LED lamps shipped with the luminaire and for luminaires with replaceable drivers ("ES2 Product(s)") for three (3) years from the date of shipment from the factory. The LED arrays in the ES1 and ES2 Product(s) will be considered defective in material or workmanship only if a total of 20% or more of the individual light emitting diodes in the Product(s) fail to illuminate. Ballasts, integral control devices, emergency batteries and poles are excluded from the General Warranty.

DLC Products, ES1 Products and ES2 Products are collectively referred to herein as the "Product(s)".

This Statement of Limited Warranty ("Warranty") applies only when the Product(s) are installed in applications in which ambient temperatures are within the range of specified operating temperatures and are operated within the electrical values shown on the LED driver Label. The Company will not be responsible under this Warranty for any failure of the Product(s) that results from external causes such as: acts of nature; physical damage; exposure to adverse or hazardous chemical or other substances; use of reactive cleaning agents and/or harsh chemicals to clean the Product(s); environmental conditions; vandalism; fire; power failure, improper power supply, power surges or dips, and/or excessive switching; induced vibration; animal or insect activity; fault or negligence of purchaser, any end user of the Product(s) and/or any third party not engaged by the Company; improper or unauthorized use, installation, handling, storage, alteration, maintenance or service, including failure to abide by any product classifications or certifications, or failure to comply with any applicable standards, codes, recommendations, product specification sheets, or instructions of the Company; use of the Product(s) with products, processes or materials supplied by any end user or third party; or any other occurrences beyond the Company's reasonable control. The Company also will not be responsible under this Warranty for any substantial deterioration in the Product finish that is caused by failure to clean, inspect or maintain the finish of the Product(s). For the Product(s) installed outdoors are subject to change due to prolonged exposure to sunlight, pollutants and other environmental conditions. Therefore, any claim for fading, discoloration or "patina" of a finish on the Product(s) installed outdoors is not applicable to the Warranty. Any finish claim due to coastal environment conditions is not applicable to the Warranty. Neither polycarbonate nor acrylic material

used in the Products is warranted against yellowing, as yellowing may naturally occur over time due to normal aging. The Product(s) are not warranted against cost resulting from installation of a third-party components, failures of third party supplied components, or failures of the Company supplied Product(s) caused by a third party supplied component.

If the Product(s) fail to comply with the terms of this Warranty, the Company, at its option, will replace the Product(s) with the same or a functionally equivalent Product(s) or component part(s). This Warranty excludes labor and equipment required to remove and/or reinstall original or replacement parts. This Warranty extends only to the Product(s) as delivered to, and is for the sole and exclusive benefit of, the original purchaser of the Product(s) at the original location. This Warranty may not be transferred or assigned by the original purchaser. The replacement of any Product(s) or component part within the Product(s) is the sole and exclusive remedy for failure of the Product(s) to comply with the terms of this Warranty and does not extend the Warranty period. Warranty claims regarding the Product(s) must be submitted in writing within (30) days of discovery of the defect or failure to an authorized Company customer service representative. Product(s) or component part(s) may be required to be returned for inspection and verification of non-conformance by Company, but no Product(s) or component part(s) will be accepted for inspection, verification or return unless accompanied by a "return authorization number" which can be obtained only from an authorized Company customer service representative. Company is not responsible for any costs and expenses incurred in connection with shipment of Product(s) to Company.

The total liability of Company on any and all claims of any kind arising out of the Company's performance or breach of this Warranty, or from Company' sale, delivery, resale, repair, or replacement of any Product(s) or the furnishing of any services, shall in no event exceed the purchase price allocable to the Product(s) that give rise to the claim, and any and all such liability shall terminate upon the expiration of the warranty period specified above.

Except as set forth herein, the Company provides no other warranties, express or implied, including but not limited to the warranties of merchantability, noninfringement or fitness for a particular purpose. THE COMPANY SHALL NOT BE LIABLE FOR ANY INCIDENTAL OR CONSEQUENTIAL DAMAGES.

This warranty gives you specific legal rights, and you may also have other rights which vary from state to state. Some states do not allow the exclusion or limitation of incidental or consequential damages, so the above limitation or exclusion may not apply to you.

Company reserves the right to modify or discontinue this Warranty without notice provided that any such modification or discontinuance will only be effective with respect to any Product(s) purchased after such modification or discontinuance.

Contact us:

Tel: 1-800-221-3379

Address: P.O. Box 2778, Newport News, VA 23609