



LIGHTING FIXTURE COMPANY

ASSEMBLY AND INSTALLATION INSTRUCTIONS for the **341281** Fixture

Important Safety information (Please read before proceeding)

1. Remove the fixture, parts and all mounting hardware bags (orange) from the carton and verify that all parts are present according to the illustration sheet. All parts must be used as indicated. Do not replace any parts, leave any parts out, or use any parts which are worn out or broken. **Failure to follow the instructions could cause a hazardous situation, voids the warranty and violates the U.L. listing of the fixture.**
2. To prevent the electric shock, turn off the main power at the circuit breaker before installing the fixture. **NEVER attempt to install, clean or replace bulbs without shutting off the electricity to the fixture.**
3. **Never use light bulbs with wattage ratings that exceed the fixtures maximum rating.** Always make sure the electric current is turned off before changing the bulbs.
4. If you experience difficulties installing the lighting fixture or it fails to work as expected, please contact a local qualified licensed electrical contractor.
5. Please contact your local Capital Lighting Fixture reseller with any assembly or installation questions. Your local reseller can also provide you with replacement parts for your new fixture.

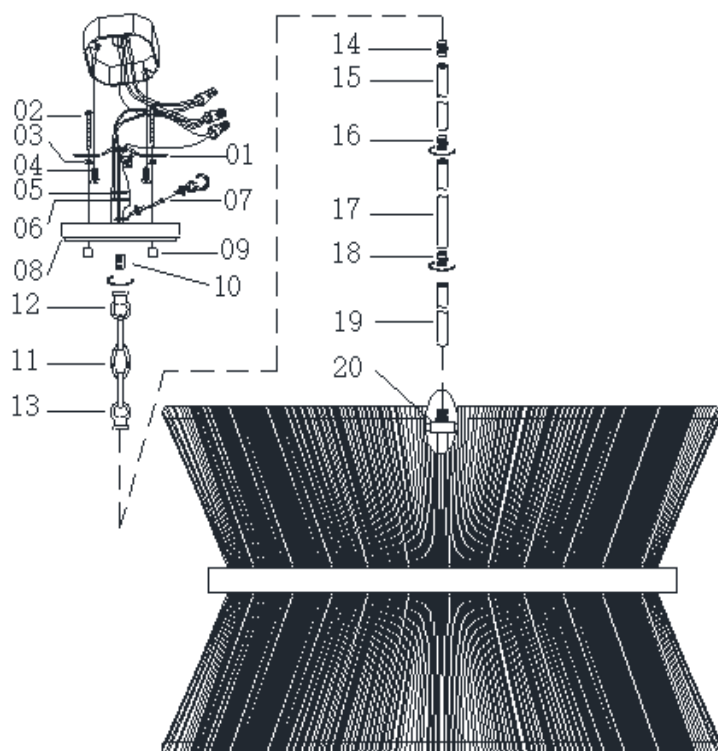

Components

- 01. Mounting Bar w/Green Screw
- 02. Mounting Screws
- 03. Hex Nut (8/32)
- 04. Outlet Box Mounting Screws
- 05. Hex Nut (1/8IP)
- 06. Lock Washer
- 07. Safety Cable w/Hook
- 08. Canopy
- 09. Cylinder Nuts
- 10. Nipple
- 11. Chain
- 12. Loop (1/8IP)
- 13. Loop (1/8IP)
- 14. Coupler (Dual-Head 1/8IP)
- 15. Rod
- 16. Coupler (Dual-Head 1/8IP)
- 17. Rod
- 18. Coupler (Dual-Head 1/8IP)
- 19. Rod
- 20. Fixture

Assembly Instructions to HANG the 341281 Fixture by the Chain

1. Pass lead wire from Fixture (20) through Rod (19), Coupler (18), Rods (17), Coupler (16), Rods (15), Coupler (14) and Loop (13), then screw all together. *Note: The Fixture Height can be adjusted by varying the number of rods or chain used in the assembly.*
2. Pass lead wire through Chain (11), Loop (12), Nipple (10) and Canopy (08), then slip Safety Cable with Hook (07), Lock Washer (06), thread Hex Nut (05) onto Nipple (10). Finally, tighten Hex Nut (05) to secure Loop (12) to Canopy (08).
3. Find appropriate threaded holes on Mounting Bar (01), and assemble Mounting Screws (02) into threaded holes with Hex Nuts (03).
4. Attach Mounting Bar (01) to Outlet Box with Outlet Box Mounting Screws (04).
5. Raise whole Fixture (20) toward outlet box, then hang it onto Mounting Bar (01) with Safety Cable w/Hook (07). *Note: This will allow for fixture to be supported while wire connections are made.*
6. Connect fixture ground wire to the outlet box ground wire with wire connector supplied; connect the common wire of the lamp cord to the power supply white wire with wire connector supplied; connect supply wire of the lamp cord to the power supply black wire with wire connector supplied. *Note: This fixture is wired using 2 conductor Lamp cord. The insulation between the two conductors on the lamp cord can be split down the center for better access to the two conductors. The common wire on the lamp cord is identified as the conductor with ribs embossed in the rubber wire insulation.*
7. Push Canopy (08) to ceiling, carefully passing Mounting Screws (02) through holes in Canopy (08), then verify all wires are securely inside Canopy (08). Finally, secure fixture to ceiling with Cylinder Nuts (09).



ASSEMBLY AND INSTALLATION INSTRUCTIONS for the **341281** Fixture

Important Safety information (Please read before proceeding)

1. Remove the fixture, parts and all mounting hardware bags (orange) from the carton and verify that all parts are present according to the illustration sheet. All parts must be used as indicated. Do not replace any parts, leave any parts out, or use any parts which are worn out or broken. **Failure to follow the instructions could cause a hazardous situation, voids the warranty and violates the U.L. listing of the fixture.**
2. To prevent the electric shock, turn off the main power at the circuit breaker before installing the fixture. **NEVER attempt to install, clean or replace bulbs without shutting off the electricity to the fixture.**
3. **Never use light bulbs with wattage ratings that exceed the fixtures maximum rating.** Always make sure the electric current is turned off before changing the bulbs.
4. If you experience difficulties installing the lighting fixture or it fails to work as expected, please contact a local qualified licensed electrical contractor.
5. Please contact your local Capital Lighting Fixture reseller with any assembly or installation questions. Your local reseller can also provide you with replacement parts for your new fixture.

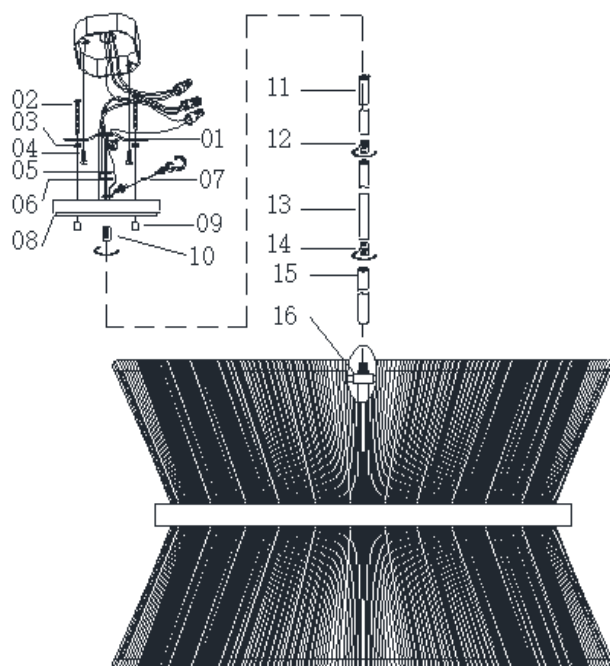

Components

- 01. Mounting Bar w/Green Screw
- 02. Mounting Screws
- 03. Hex Nut (8/32)
- 04. Outlet Box Mounting Screws
- 05. Hex Nut (1/8IP)
- 06. Lock Washer
- 07. Safety Cable w/Hook
- 08. Canopy
- 09. Cylinder Nuts
- 10. Nipple
- 11. Rod
- 12. Coupler (Dual-Head 1/8IP)
- 13. Rod
- 14. Coupler (Dual-Head 1/8IP)
- 15. Rod
- 16. Fixture

Assembly Instructions to ROD MOUNT the 341281 Fixture

1. Pass lead wire from Fixture (16) through Rod (15), Coupler (14), Rods (13), Coupler (12) and Rods(11), then screw all together. Note: *The fixture height can be adjusted by the number of rods installed in the fixture.*
2. Pass lead wire through Nipple (10) and Canopy (08), then slip Safety Cable with Hook (07), Lock Washer (06), thread Hex Nut (05) onto Nipple (08). Finally, tighten Hex Nut (05) to secure Canopy (08).
3. Find appropriate threaded holes on Mounting Bar (01), and assemble Mounting Screws (02) into threaded holes with Hex Nuts (03).
4. Attach Mounting Bar (01) to Outlet Box with Outlet Box Mounting Screws (04).
5. Raise whole Fixture (16) toward outlet box, then hang it on Mounting Bar (01) with Safety Cable w/Hook (07). Note: *This will allow for fixture to be supported while wire connections are made.*
6. Connect fixture ground wire to the outlet box ground wire with wire connector supplied; connect the common wire of the lamp cord to the power supply white wire with wire connector supplied; connect supply wire of the lamp cord to the power supply black wire with wire connector supplied. Note: *This fixture is wired using 2 conductor Lamp cord. The insulation between the two conductors on the lamp cord can be split down the center for better access to the two conductors. The common wire on the lamp cord is identified as the conductor with ribs embossed in the rubber wire insulation.*
7. Push Canopy (08) to ceiling, carefully passing Mounting Screws (02) through holes in Canopy (08), then verify all wires are securely inside Canopy (08). Finally, secure fixture to ceiling with Cylinder Nuts (09).