



FNW COPPER PRESS FITTINGS
TECHNICAL INFORMATION



TABLE OF CONTENTS

1. OVERVIEW	2		
2. TECHNICAL INFORMATION AND APPLICATIONS	3		
2.1 Materials	3		
2.2 Profile	4		
2.3 Markings and Traceability	5		
2.4 Approvals and Certifications	5		
2.5 Compliance	5		
2.6 Leak Detection	5		
2.7 Leak Detection Under Pressure	6		
2.8 Applications	7		
3. PRODUCT AND INSTALLATION INSTRUCTIONS	8		
3.1 Freezing and Anti-Freezing	8		
3.2 Corrosion Protection	8		
3.3 Thermal Expansion	9		
3.4 Pressure Drops	10		
3.5 Pipe Selection	11		
3.6 Press Tool Selection	12		
3.7 Handling and Storage	12		
3.8 Pipe Hangers and Supports	13		
3.9 Minimum Distance Between Fittings and Bends in Pipe or Tubing	13		
3.10 Minimum Distance Between Joints	14		
3.11 Spacing Requirements for Correct Press Tool Operation	15		
3.12 Minimum Distance Between Press and Soldered or Brazed Joints	16		
3.13 Maintenance	17		
3.14 Installation Instructions for 1/2"–2" Press Fittings	18		
3.15 Installation Instructions for 2-1/2"–4" Press Fittings	19		
4. DIMENSIONAL INFORMATION	20		
5. LIMITED WARRANTY	46		

OVERVIEW

FEATURES

- Sizes 1/2" to 4"; including elbows, couplings, straight tees, reducing tees, adapters, reducers, caps, unions, flanges, dielectric unions and crossovers
- Leak detection feature for easy identification of unpressed and incorrectly pressed joints
- BIM available for commercial/mechanical job needs
- Factory-installed EPDM Seals
- Compatible with most major pressing tools and jaws available in the market
- Manufactured in Italy



APPROVED APPLICATIONS

- Potable water
- Heating/cooling (Up to 50% ethylene or propylene glycol as additive)
- Rain water/gray water
- Non-potable and treated water
- Compressed air (200 psi max)
- Non-medical gases (125–200 psi max depending on application)
- Low-pressure steam (15 psi/248°F max)
- Vacuum (29.2" mercury max @ 140°F)



SYSTEM SPECIFICATIONS

- Operating pressure: 300 psi max
- Temperature range: 32°F–250°F (Potable Water) 0°F–250°F (Hydronic Systems)
- Suitable for ASTM B88 types K, L and M. Hard-drawn copper tube nominal 1/2"–4" and soft copper tube limited to nominal sizes 1/2"–1-1/4"

APPROVALS AND CERTIFICATIONS

- NSF/ANSI/CAN 61-2023, Drinking Water Systems Components–Health Effects
- NSF/ANSI/CAN 372-2022, Drinking Water System Components–Lead Content
- IAPMO/ANSI/CAN Z1117-2022, Press Connections
- ICC-ES LC1002-2010 (Editorially revised Feb 2013), Press-Connection Fittings for Potable Water Tube and Radiant Heating Systems
- IAPMO PS 66-2023 Dielectric Unions

COMPLIANCE WITH THE FOLLOWING CODES

2024, 2021, 2018, 2015, 2012, 2009 and 2006 International Plumbing Code® (IPC) • 2024, 2021, 2018, 2015, 2012, 2009 and 2006 International Mechanical Code® (IMC) • 2021, 2018, 2015, 2012, 2009 and 2006 International Residential Code® (IRC) • 2024, 2021, 2018, 2015, 2012, 2009 Uniform Plumbing Code® (UPC) • 2024, 2021, 2018, 2015, 2012, 2009 Uniform Mechanical Code® (UMC) • 2022, 2019, 2016, 2013 and 2010 California Plumbing Code (CPC) • 2022, 2019, 2016, 2013 and 2010 California Mechanical Code (CMC) • 2023, 2020, 2017 City of Los Angeles Plumbing Code • 2023, 2020, 2017 City of Los Angeles Mechanical Code • 2021, 2017, and 2007 Code of Massachusetts Regulation 248 CMR 10.00: Uniform State Plumbing Code • 2021 and 2017 Massachusetts State Building Code 780 CMR Ninth Edition: Chapter 28 • 2020, 2015 and 2010 National Plumbing Code of Canada® (NPC) • ASME B16.51 -2021 Copper and Copper Alloy Press-Connect Pressure Fittings (Copper)

FNW WARRANTY: 50-year limited warranty against defects in material and workmanship.

TECHNICAL INFORMATION AND APPLICATIONS

2.1 MATERIALS

- FNW Copper Press fittings are produced in certified ISO 9001 factories with high-quality material, using industry-leading manufacturing practices.
- Fittings featuring two or more press sides and/or thread ends between 2-1/2"–4" are made with high-quality copper Cu-DHP (C12200). Phosphorus-Deoxidized Copper-Cu-DHP, with a nominal composition of 99.9% minimum copper and 0.02% phosphorus, is the most widely used copper for tube and fittings in plumbing applications.
- Fittings featuring threaded ends through 2" are made with lead-free CR brass (C27453). The C27453 alloy meets the strict lead content requirements of the US market for potable water. The C27453 alloy is an excellent material for press fittings, with good dezincification resistance.
- Fittings featuring press sides utilize a factory-installed, high-quality black EPDM sealing element. EPDM (Ethylene Propylene Diene Monomer) is a synthetically manufactured material with high performance and good aging resistance for safe and durable use in most commercial and industrial applications. EPDM seals can be used in a temperature range between 0°F and +250°F with traditional water use.
- Fittings featuring 2-1/2" and above (XLC Profile) press connections utilize EPDM seals, stainless steel gripping rings and industry standard nylon spacers.

TECHNICAL INFORMATION AND APPLICATIONS

2.2 PROFILE

FNW Copper Press Fittings (1/2"–2") feature a V profile allowing pressing at 3 points to optimize the seal and create a strong and durable pipe-fitting junction. This profile is recognizable by the safety cylindrical guides that ensure proper insertion of the tube, while protecting the O-ring against damage.

V PROFILE FROM 1/2"–2"

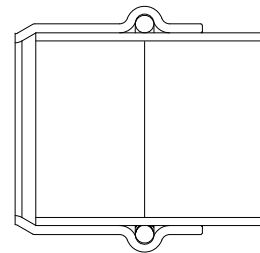
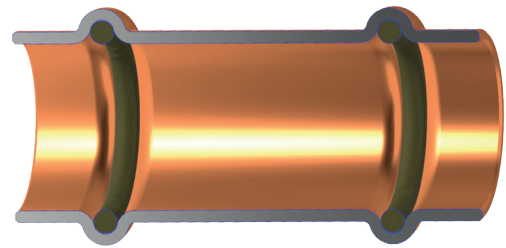

FNW Copper Press Fittings (2-1/2"–4") feature an XLC profile designed for maximum safety. An internal stainless steel gripping ring (placed upstream of the O-ring and following the direction of insertion of the pipe) grips into the tube when the joint is pressed, creating a strong, durable and safe joint. A nylon separation ring, placed between the gripping ring and the O-ring, protects the seal, making the pipe insertion operation safer.

XLC PROFILE FROM 2-1/2"–4"

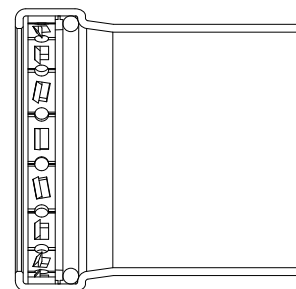
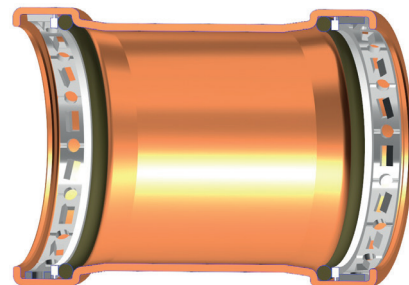

TECHNICAL INFORMATION AND APPLICATIONS

2.3 MARKINGS AND TRACEABILITY

Each FNW Copper Press Fitting is marked with the following:

- FNW
- Country of origin (Italy)
- Fitting size
- Manufacturing date
- NSF/ANSI 61 and 372
- cUPC.
- PW mark (potable water)

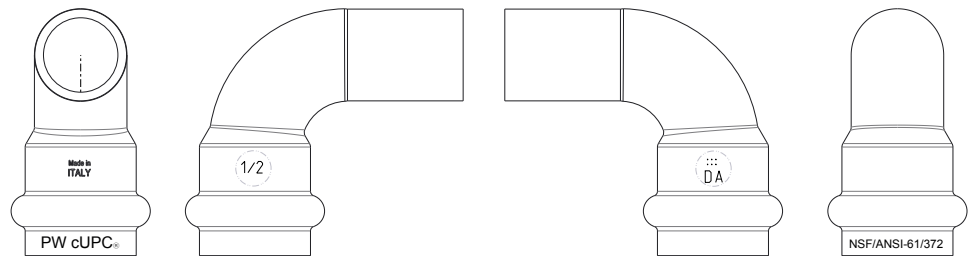

2.4 APPROVALS AND CERTIFICATIONS

- NSF/ANSI/CAN 61-2023, Drinking Water Systems Components–Health Effects
- NSF/ANSI/CAN 372-2022, Drinking Water System Components–Lead Content
- IAPMO/ANSI/CAN Z1117-2022, Press Connections
- ICC-ES LC1002-2010 (Editorially revised Feb 2013), Press-Connection Fittings for Potable Water Tube and Radiant Heating Systems
- IAPMO PS 66-2023 Dielectric Unions

2.5 COMPLIANCE WITH THE FOLLOWING CODES

2024, 2021, 2018, 2015, 2012, 2009 and 2006 International Plumbing Code® (IPC) • 2024, 2021, 2018, 2015, 2012, 2009 and 2006 International Mechanical Code® (IMC) • 2021, 2018, 2015, 2012, 2009 and 2006 International Residential Code® (IRC) • 2024, 2021, 2018, 2015, 2012, 2009 Uniform Plumbing Code® (UPC) • 2024, 2021, 2018, 2015, 2012, 2009 Uniform Mechanical Code® (UMC) • 2022, 2019, 2016, 2013 and 2010 California Plumbing Code (CPC) • 2022, 2019, 2016, 2013 and 2010 California Mechanical Code (CMC) • 2023, 2020, 2017 City of Los Angeles Plumbing Code • 2023, 2020, 2017 City of Los Angeles Mechanical Code • 2021, 2017, and 2007 Code of Massachusetts Regulation 248 CMR 10.00: Uniform State Plumbing Code • 2021 and 2017 Massachusetts State Building Code 780 CMR Ninth Edition: Chapter 28 • 2020, 2015 and 2010 National Plumbing Code of Canada® (NPC) • ASME B16.51 -2021 Copper and Copper Alloy Press-Connect Pressure Fittings (Copper)

2.6 LEAK DETECTION

Each FNW Copper Press, press style joint is designed for easy detection of an unpressed joint during an industry standard air or water leak test. Thanks to this "unpressed" leak detection design, any leaks can be quickly and reliably identified by pressurizing the system after installation, avoiding time-consuming and costly future repairs.

- FNW Copper Press Fittings up to 2 inches utilize a specially designed O-ring with leak paths designed to leak if the joint is not properly pressed.
- FNW Copper Press Fittings 2-1/2"–4" utilize a specially designed sealing joint that will leak if the joint is not properly pressed.



TECHNICAL INFORMATION AND APPLICATIONS

2.7 LEAK TESTING UNDER PRESSURE

After installation, leak testing should be completed to verify that all joints are properly pressed. This can be accomplished by pressurizing the system in accordance with any applicable state or local regulations and in compliance with the maximum performances indicated for the FNW Copper Press Systems. Below are general procedures to perform leak testing under pressure. Do not cover or insulate any fitting before testing; do not over pressurize the system and always follow all applicable state and local regulations.

Water leak testing:

1. The water pressure test should be done immediately before the start-up phase, at least 7 days before using potable water.
2. Fill the isolated system using clean potable water and slowly pressurize to 50 psi. Appropriate industry standard venting should be used as required.
3. Stabilize the system for a minimum of 2 hours and monitor with an appropriate pressure gauge.
4. During the pressure test, check for visible water leaks and loss of pressure on the gauge which can indicate potential leaks.
5. After any un-pressed connection has been tested and repaired, repeat the testing process until all joints are verified to be leak free.
6. Once the system has been confirmed to be leak free, water pressure can be increased to the appropriate working pressure to verify the system is working properly (always remember not to exceed the maximum working pressure of the product stated in the technical documentation).

Air leak testing:

1. The air pressure leak test must be conducted using clean, dry, oil free, compressed air or nitrogen.
2. Fill the isolated system and pressurize slowly up to 15 psi. Stabilize for at least 2 hours and monitor with an appropriate pressure gauge.
3. Monitor the pressure during testing to ensure it does not change due to environmental impacts such as temperature variation.
4. During the pressure test, check for visible leaks and any loss of pressure on the gauge which can indicate potential leaks.
5. After any un-pressed connection has been tested and repaired, repeat the testing process until all joints are verified.
6. Once the system has been confirmed to be leak free, pressure can be increased to the working pressure to verify the system is working properly (always remember not to exceed the maximum working pressure of the product stated in the technical documentation).

TECHNICAL INFORMATION AND APPLICATIONS

2.8 APPLICATIONS

FNW Copper Press Systems are approved for numerous applications in commercial and residential markets including potable water. The press fittings meet the requirements of NSF/ANSI/CAN 61 and the lead-free specifications through testing under NSF/ANSI/CAN 372.

FNW Copper Press Systems are also suitable for use in many other applications, such as heating and cooling, oil-free compressed air (residual oil < 5 mg/m³, per ISO 8573-1) non-potable and treated water.

FLUIDS/POTABLE WATER

Application	Comments	Max pressure (psi)	Operating temperature (°F)
Drinking water	-	300	+32/+250
Heating/cooling	Up to 50% ethylene or propylene glycol as additive	300	0/+250
Rain water/gray water	-	300	+32/+250
Non-potable and treated water	-	300	+32/+250
Low-pressure steam	-	Up to 15 psi	Max 248
Ethanol	-	200	Up to 140

NON-MEDICAL GASES

Application	Comments	Max pressure (psi)	Operating temperature (°F)
Compressed air	Oil residual < 5 mg/m ³ (per ISO 8573-1)	200	Up to 140
Oxygen-O2	Not for medical use	140	Up to 140
Nitrogen-N2	-	200	Up to 140
Argon	Welding use	200	Up to 140
Hydrogen-H2	-	125	Up to 140
Vacuum	Rough vacuum	29,2 inch. Hg	Up to 140
Carbon Dioxide-CO2	Dry	200	Up to 140

For any other application not indicated in the table, for higher concentration of a substance or for any applications outside listed temperatures and pressure ranges, please consult your FNW representative.

PRODUCT AND INSTALLATION INSTRUCTIONS

3.1 FREEZING AND ANTI-FREEZING

Freezing water increases in volume which can cause breakage of tanks and deformations in the sections of the system where the volume increase occurs due to freezing conditions. Care should be taken to protect the piping system as temperatures approach freezing, using industry accepted methods and according to local code requirements. When using FNW Copper Press Fittings in systems where temperatures approach 32°F, system drainage is recommended. In case of a pressure test during the cold period, the use of compressed air or inert gas should be used. Stresses due to frost or freezing of the pipeline could also negatively affect the seal of the fitting, reducing performance and causing undesired leaks. In some cases, the use of antifreeze systems (non-potable water systems only) that are designed to ensure circulation within the system even at low temperatures is recommended. In case of the use of anti-corrosion or antifreeze additives, it is recommended to consult your FNW representative to verify suitability of the chemical composition of the additive, as it could damage the O-ring over time, compromising durability and reliability.

3.2 CORROSION PROTECTION

FNW Copper Press Systems with copper tubing are approved for underground installations where allowed and in accordance with local and state regulations. Above ground usage of copper tubing and fittings do not normally require external corrosion protection with the following exceptions:

- Contact with aggressive building materials such as nitrite or materials containing ammonium
- In aggressive environments

Installations must meet all state and local codes, including those for underground use and require the proper authorization according to the governing codes and/or local authorities. FNW Copper Press Systems that could be exposed to corrosive action, such as due to soil conditions or moisture, must be protected in an approved manner in accordance with NACE Standard RP0169-2002 or satisfying local code requirements. In addition, systems should be properly sized to minimize the risk of erosion corrosion resulting from excessive velocities (erosion corrosion). Water installations containing mixed metal systems can have a detrimental effect on each other and cause corrosion. Generally, copper tubing should not be installed directly upstream from galvanized steel pipe, and dielectric unions should be used when connecting copper to steel or galvanized steel pipe. The flow rule must be observed in all mixed installations with tubing made of copper and pipes made of galvanized steel. Some examples are shown in the illustration to the right.

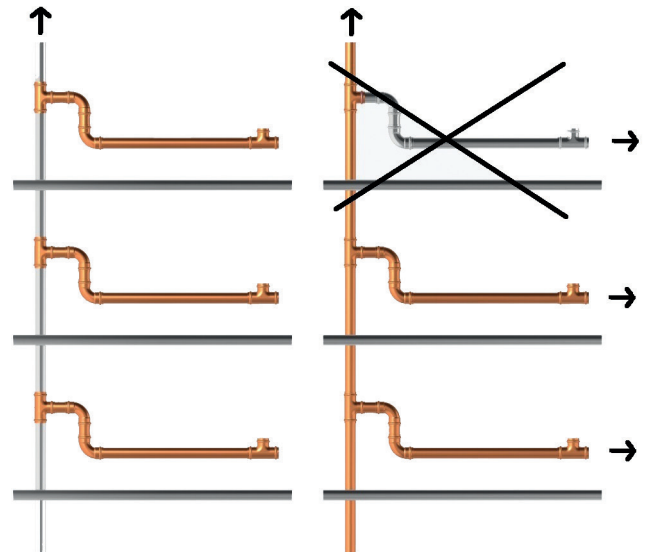

PRODUCT AND INSTALLATION INSTRUCTIONS

3.3 THERMAL EXPANSION

All pipes and fittings within a system experience thermal expansion and contraction depending upon the specific material of the pipe or fitting, system fluid, temperature and the installation environment. To compensate for expansion and contractions within the system, the proper placement of fixed or sliding support points and any applicable line compensators should be used in accordance to industry standards and as required by any state or local regulations. Expansion joints or mechanical expansion compensators may be used to alleviate stresses due to contraction and expansion. FNW Copper Press Systems do not require any additional protection as compared to a soldered or a grooved system and the following methods are effective:

- Fixed and sliding hangers
- Expansion equalization joints (expansion bends)
- Expansion compensators

Always refer to a specialist to select the best technical option for the specific installation, accounting for the available space, installation conditions, the thermal expansion to be compensated for, the available components and any applicable state or local regulations.

The below reference table shows the thermal expansion of a typical copper system with thermal changes (ΔT) and different lengths:

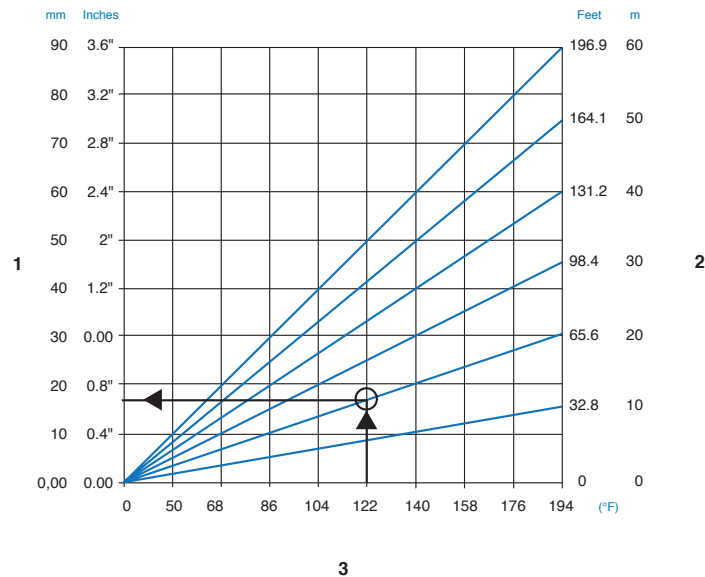

1. Length expansion Δl (inches/mm))
2. Pipe length (ft)
3. Temperature difference (°F)

PRODUCT AND INSTALLATION INSTRUCTIONS

3.4 PRESSURE DROPS

Correct system sizing requires the evaluation of pressure losses due to the movement of fluid through the pipes and fittings. Pressure losses are generated by fluid passing through the pipe (continuous or distributed losses) and any connections (localized or accidental losses).

The below tables can be used in the calculation of pressure losses for FNW Copper Press Fittings by using an equivalent length of a straight length tube with the same diameter that would have the same pressure drop. All length-equivalent values for each fitting type in the table are to be added to the actual length of the supply network. This method is not as accurate as the direct analytical method but has the advantage that the calculation can be carried out faster. It is the responsibility of the end user to determine if this method meets the specific requirements of the pressure drop calculations needed for the overall system that is being installed.

Equivalent lengths for wrought copper fittings										
Size	90° elbow		45° elbow		Tee branch		Tee run		Coupling	
	Ft	m	Ft	m	Ft	m	Ft	m	Ft	m
1/2"	1	0.30	0.5	0.15	2	0.60	-	-	-	-
3/4"	2	0.60	0.5	0.15	3	0.90	-	-	-	-
1"	2.5	0.75	1	0.30	4.5	1.35	-	-	-	-
1-1/4"	3	0.90	1	0.30	5.5	1.65	0.5	0.15	0.5	0.15
1-1/2"	4	1.20	1.5	0.45	7	2.15	0.5	0.15	0.5	0.15
2"	5.5	1.65	2	0.60	9	2.75	0.5	0.15	0.5	0.15
2-1/2"	7	2.15	2.5	0.75	12	3.65	0.5	0.15	0.5	0.15
3"	9	2.75	3.5	1.00	15	4.50	1	0.30	1	0.30
4"	12.5	3.75	5	1.50	21	6.40	1	0.30	1	0.30

Values are purely indicative and may be subject to change due to production requirements.

Equivalent lengths for cast copper alloy fittings						
Size	90° elbow		Tee run		Tee branch	
	Ft	m	Ft	m	Ft	m
1/2"	1	0.30	0.5	0.15	2	0.60
3/4"	2	0.60	0.5	0.15	3	0.90
1"	4	1.20	0.5	0.15	5	1.50
1-1/4"	5	1.50	1	0.30	7	2.15
1-1/2"	8	2.50	1	0.30	9	2.75
2"	11	3.35	2	0.60	12	3.65

Values are purely indicative and may be subject to change due to production requirements.

PRODUCT AND INSTALLATION INSTRUCTIONS

3.5 PIPE SELECTION

FNW Press Systems are suitable for installation with copper tube in accordance to ASTM B88 types K, L and M. Hard-drawn copper tube nominal 1/2"–4" and soft copper tube limited to nominal sizes 1/2"–1-1/4"

The below table represents general ASTM B88 requirements, please reference the standard for more details:

ASTM B88												
	External diameter		Tolerance				Thickness					
			Annealed		Drawn		K		L		M	
	Inches	mm	Inches	mm	Inches	mm	Inches	mm	Inches	mm	Inches	mm
1/2"	0.625	15.875	0.001	0.025	0.003	0.064	0.049	1.2446	0.040	1.016	0.028	0.711
3/4"	0.875	22.225	0.001	0.025	0.003	0.076	0.065	1.651	0.045	1.143	0.032	0.813
1"	1.125	28.575	0.002	0.038	0.004	0.089	0.065	1.651	0.050	1.270	0.035	0.889
1-1/4"	1.375	34.925	0.002	0.038	0.004	0.102	0.065	1.651	0.055	1.397	0.042	1.066
1-1/2"	1.625	41.275	0.002	0.051	0.005	0.114	0.072	1.829	0.060	1.524	0.049	1.245
2"	2.125	53.975	0.002	0.051	0.005	0.127	0.083	2.108	0.070	1.778	0.058	1.474
2-1/2"	2.625	66.675	0.002	0.051	0.005	0.127	0.095	2.413	0.080	2.032	0.065	1.651
3"	3.125	79.375	0.002	0.051	0.005	0.127	0.109	2.769	0.090	2.286	0.072	1.829
4"	4.125	104.775	0.002	0.051	0.005	0.127	0.134	3.404	0.110	2.279	0.095	2.413

PRODUCT AND INSTALLATION INSTRUCTIONS

3.6 PRESS TOOL SELECTION

FNW Press Systems are compatible with most standard electric or battery-powered press tools using jaws specific to a V-shaped profile. FNW Press Systems have specifically been tested with:

1. Milwaukee
2. RIDGID

Always refer to the Tool Manufacturer's manual for selection of tools, jaws, tool operating instructions, tool maintenance and additional technical information.

The following best practices should be applied:

- Jaws require cleaning to remove copper buildup or chips. Typically, cleaning is performed dry with an abrasive pad; however, specific jaw cleaning instructions are included in the jaw manufacturer's operating instructions. Jaw cleaning intervals will vary by size, material and engineering design. Jaws may require periodic inspections and/or re-calibration; check the jaw manufacturer's operating instructions for details.
- Pressing tools (sometimes called press tools or guns) require periodic inspection and re-calibration. Specific recommendations vary by manufacturer and model number; always consult the operating instructions provided with the pressing tool.
- Jaw cleanliness, jaw inspection/re-calibration (if required) and periodic pressing tool re-calibration/inspection are the responsibility of the installer. Failure to maintain the pressing tool, jaw or actuator may void the manufacturer's warranty.

3.7 HANDLING AND STORAGE

Care should be taken with FNW Press Fittings, materials and any necessary tools that will be used to ensure they are not damaged during handling, storage or during transportation.

- Do not pull or drag the fittings or system components along other surfaces.
- Secure fittings, tubing and system components during transportation to keep them from shifting.
- Don't remove the fittings from the package until immediately before installing.
- Store fittings and system components in a clean and dry place.
- Do not store components directly on the floor.
- Where possible, store different sizes separately (store small sizes on top of larger sizes if separate storage is not possible).
- Store fittings and system components of different materials separately to prevent contact corrosion.
- Do not store components unpacked and/or exposed to direct sunlight.

PRODUCT AND INSTALLATION INSTRUCTIONS

3.8 PIPE HANGERS AND SUPPORTS

Tubing supports perform two functions: to provide support for the tubing and to guide the tube during thermal expansion and contraction. FNW Copper Press Fittings require no special requirements for support, but must not be used as the support. All industry standard practices and guidelines should be used for tube layout and support, and all hangers and supports must conform to the local code requirements.

In the absence of local code requirements, hangers and supports should conform to ANSI/MSS SP 58 (pipe hangers and supports-materials, design, manufacture, selection, application and installation). As a rule, use copper ring hangers or, if steel, use those with a barrier made with plastic, felt or rubber lining. This type of support allows for acoustic isolation and dampening of any rustling and vibration, while preventing undesirable galvanic corrosion due to contact between dissimilar metals.

Some general rules for hangers include:

- Never place fixed hangers too close to a fitting. Figure 1 sets a minimum distance from the hanger to a press joint.
- Hangers should be positioned to ensure that they allow for slight movements of the pipe due to water hammer or other outside forces. (Fig. 2 and 3).

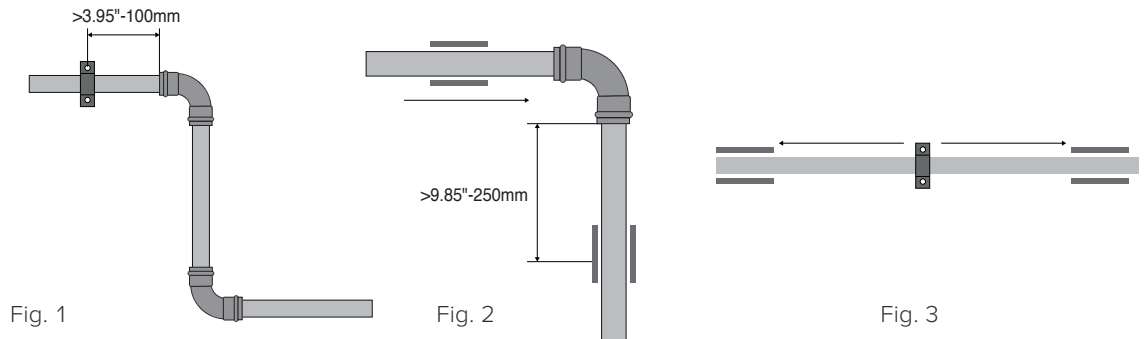

3.9 MINIMUM DISTANCE BETWEEN FITTINGS AND BENDS IN PIPE OR TUBING

A minimum distance must be maintained between bends in pipes or tubing and installation of fittings to ensure a correct joint. Refer to the below picture for more details.

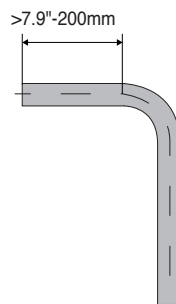

PRODUCT AND INSTALLATION INSTRUCTIONS

3.10 MINIMUM DISTANCE BETWEEN JOINTS

The below tables represent general minimum installation distances between:

1. Two press ends
2. A press fitting and a wall or other type of pass through installation

Please refer to your specific Press Tool Manufacturer's manual for additional details.

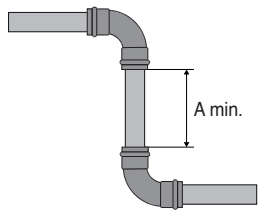

SIZE		1/2"	3/4"	1"	1-1/4"	1-1/2"	2"	2-1/2"	3"	4"
A	Inches	0.6	0.8	0.8	1	1.2	1.4	1.6	1.8	2
	mm	15	20	20	25	30	35	40	45	50

Tab. 1 - Minimum distance between two pressed fittings.



SIZE		1/2"-4"
A	Inches	1.97
	mm	50

Tab. 2 - Minimum distance from the fitting to the wall for pass-through installations.

PRODUCT AND INSTALLATION INSTRUCTIONS

3.11 SPACING REQUIREMENTS FOR CORRECT PRESS TOOL OPERATION

Proper clearances must be maintained for correct press tool attachment and operation. The below tables represent the general clearance requirements for:

1. Press tools used perpendicular to a wall
2. Press tools used at an angle to a wall and/or near corners

Please refer to your specific Press Tool Manufacturer's manual for additional details.

SIZE		1/2"	3/4"	1"	1-1/4"	1-1/2"	2"	2-1/2"	3"	4"
d	Inches	0.9	1	1	1.2	3	3.4	4.35	4.7	5.5
	mm	22	25	25	30	75	85	110	120	140
a	Inches	2.4	2.6	3	3.3	4.5	4.7	5.5	5.9	6.7
	mm	60	65	75	83	115	120	140	150	170

Tab. 3 - Minimum depths of the pipelines installed in-wall.

SIZE		1/2"	3/4"	1"	1-1/4"	1-1/2"	2"	2-1/2"	3"	4"
d	Inches	1/2	1/2	1/2	1/2	3	3.4	4.3	4.7	5.5
	mm	31	31	31	31	75	85	110	120	140
a	Inches	3.2	3.2	3.2	3.4	3	3.4	4.3	4.7	5.5
	mm	80	80	80	84	75	85	110	120	140
d1	Inches	1.1	1.4	1.4	1.7	4.5	4.7	5.5	5.9	6.7
	mm	28	35	35	44	115	120	140	150	170

Tab. 4 - Minimum depths of pipelines installed near corners.

PRODUCT AND INSTALLATION INSTRUCTIONS

3.12 MINIMUM DISTANCE BETWEEN PRESS AND SOLDERED OR BRAZED JOINTS

Proper precautions are required to prevent damage to a press connection when soldering or brazing in the vicinity. If possible, these types of processes should be completed prior to press installation and/or the press fitting should be protected from the heat effects using industry standard methods.

The minimum distance between a press fitting and soldering/brazing installation is shown in the below table:

SIZE	Soldering minimum distance (inches)	Soldering minimum distance (mm)	Brazing minimum distance (inches)	Brazing minimum distance (mm)
1/2"	1.5	38	4.5	114
3/4"	2.25	57	6.75	172
1"	3	76	9	229
1-1/4"	3.75	95	11.25	286
1-1/2"	4.5	114	13.5	343
2"	6	153	18	457
2-1/2"	7.5	191	22.5	572
3"	9	229	27	686
4"	12	305	36	915

The minimum clearance requirements between a press fitting and an existing soldered/brazed joint are shown in the below table:

SIZE	Soldering minimum distance (inches)	Soldering minimum distance (mm)	Brazing minimum distance (inches)	Brazing minimum distance (mm)
1/2"	0.25	7	1	26
3/4"	0.25	7	1.5	38
1"	0.44	11	2	51
1-1/4"	0.44	11	2.5	64
1-1/2"	0.63	16	3	76
2"	0.75	19	4	102
2-1/2"	0.25	7	5	127
3"	0.25	7	6	153
4"	0.25	7	8	204

PRODUCT AND INSTALLATION INSTRUCTIONS

3.13 MAINTENANCE

Before performing any maintenance, care must be taken to prevent injury and property damage. The following steps are recommended:

1. Shutoff all operating lines.
2. Isolate the fitting from the system.
3. Release system pressure.
4. Drain the fluid in the isolated area.

Under normal conditions, properly installed press fittings do not require specific scheduled maintenance. However, a visual inspection should always be part of any regular system maintenance, especially in systems operating under more extreme conditions.

PRODUCT AND INSTALLATION INSTRUCTIONS

3.14 INSTALLATION INSTRUCTIONS FOR 1/2"–2" PRESS FITTINGS

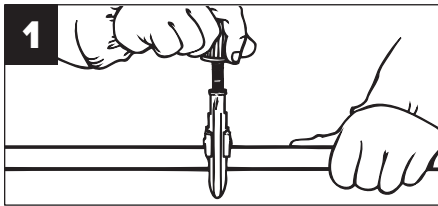

1. Cut the tube square with an appropriate industry standard tool such as a tube cutter or fine tooth saw.

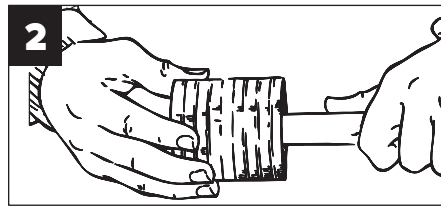

2. Carefully deburr the ID and OD with appropriate deburring tools. Ensure the tube surfaces are free of defects and debris as these can cause damage to the O-ring or prevent a correct seal.

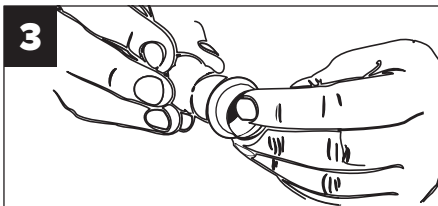

3. Verify presence, cleanliness and correct seating of the internal O-ring. Do not add lubricates. If necessary, clean water can be applied to the O-ring to aide insertion.

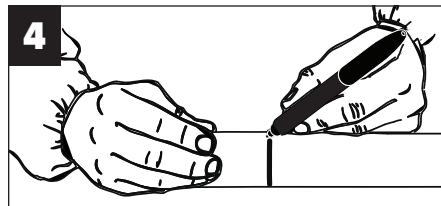

4. Mark the tube to the appropriate insertion depth per the below chart.

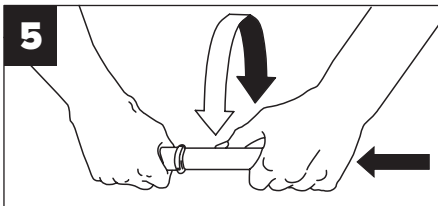

5. Rotate the tube slightly while sliding the fitting onto the tube. Make sure the tube is installed to the insertion mark and/or mechanical stop if applicable.

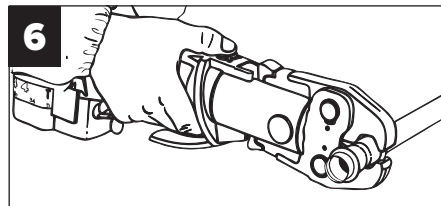

6. Place the press tool at a right angle over the fitting bead with the fitting inside the jaw in the correct position as indicated by the tool manufacturer. Follow the press tool manufacturer's instructions to complete the press.

* Tube insertion depth chart.

		1/2"	3/4"	1"	1-1/4"	1-1/2"	2"
Insertion*	Inches	0.71	0.91	0.91	1.02	1.42	1.57
	mm	18	23	24	26	36	40

PRODUCT AND INSTALLATION INSTRUCTIONS

3.15 INSTALLATION INSTRUCTIONS FOR 2-1/2"–4" PRESS FITTINGS

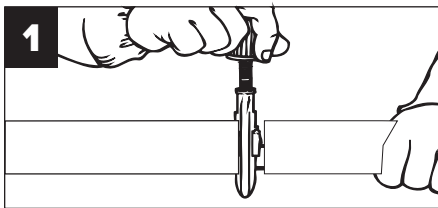

1. Cut the tube square with an appropriate industry standard tool such as a tube cutter or fine tooth saw.

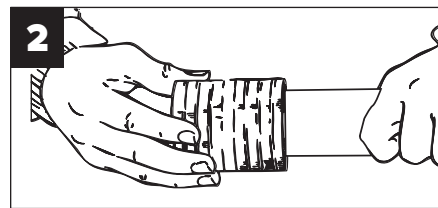

2. Carefully deburr the ID and OD with appropriate deburring tools. Ensure the tube surfaces are free of defects and debris as these can cause damage to the O-ring or prevent a correct seal.

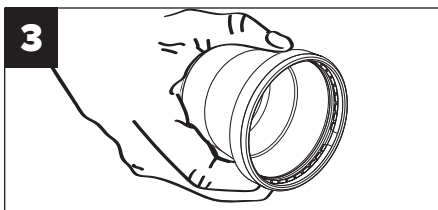

3. Verify presence, cleanliness and correct seating of the internal O-ring, gripping ring and nylon spacer. Do not add lubricates. If necessary, clean water can be applied to the O-ring to aide insertion.

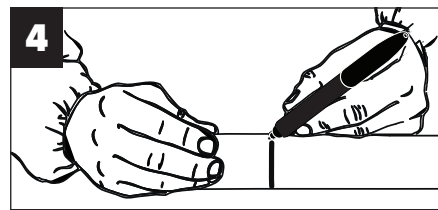

4. Mark the tube to the appropriate insertion depth per the below chart.

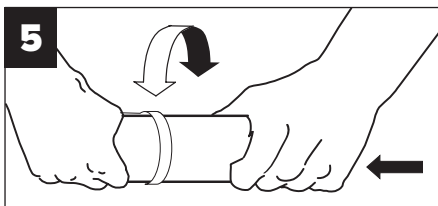

5. Rotate the tube slightly while sliding the fitting onto the tube. Make sure the tube is installed to the insertion mark and/or mechanical stop if applicable.

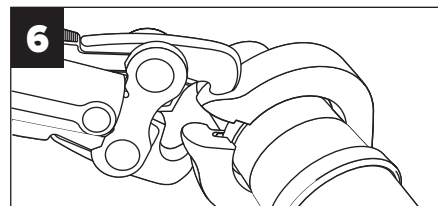

6. Place the press tool at a right angle over the fitting bead with the fitting inside the jaw in the correct position as indicated by the tool manufacturer. Follow the press tool manufacturer's instructions to complete the press.

* Tube insertion depth chart.

		2-1/2"	3"	4"
Insertion*	Inches	1.75	1.97	2.40
	mm	44	50	61

DIMENSIONAL INFORMATION

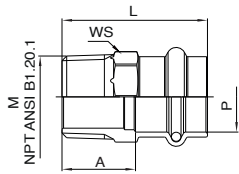
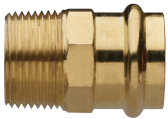

FNW5V0076

Brass Male Thread Adapter

Size (in.) P x M	FNW Code	Bag Qty.	Weight (lbs)	A	L	WS
1/2" x 3/8"	FNW5V0076DC	10	0.104	0.79	1.5	0.79
1/2" x 1/2"	FNW5V0076D	10	0.133	0.94	1.65	0.87
1/2" x 3/4"	FNW5V0076DF	10	0.144	1.04	1.75	1.06
3/4" x 1/2"	FNW5V0076FD	10	0.15	0.89	1.79	1.06
3/4" x 3/4"	FNW5V0076F	10	0.177	0.93	1.83	1.06
3/4" x 1"	FNW5V0076FG	10	0.287	1.16	2.07	1.34
1" x 3/4"	FNW5V0076GF	10	0.218	0.96	1.91	1.34
1" x 1"	FNW5V0076G	10	0.258	1.14	2.09	1.34
1" x 1-1/4"	FNW5V0076GH	1	0.506	1.52	2.46	1.73
1-1/4" x 1"	FNW5V0076HG	1	0.451	1.44	2.46	1.73
1-1/4" x 1-1/4"	FNW5V0076H	1	0.5	1.44	2.46	1.73
1-1/4" x 1-1/2"	FNW5V0076HJ	1	0.6	1.52	2.54	1.97
1-1/2" x 1-1/4"	FNW5V0076JH	1	0.61	1.14	2.56	1.97
1-1/2" x 1-1/2"	FNW5V0076J	1	0.612	1.16	2.58	1.97
1-1/2" x 2"	FNW5V0076JK	1	0.995	1.38	2.80	2.44
2" x 1-1/2"	FNW5V0076KJ	1	0.927	1.30	2.87	2.44
2" x 2"	FNW5V0076K	1	0.967	1.34	2.91	2.44

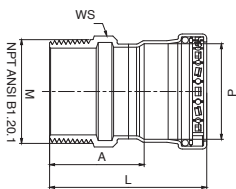
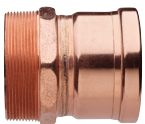

FNW5V0076 - XLC

Copper Male Thread Adapter

Size (in.) P x M	FNW Code	Bag Qty.	Weight (lbs)	A	L	WS
2-1/2" x 2-1/2"	FNW5V0076L	1	1.703	2.64	4.37	2.91
3" x 3"	FNW5V0076M	1	2.477	2.78	4.74	3.54
4" x 4"	FNW5V0076P	1	3.891	3.54	5.94	4.53

DIMENSIONAL INFORMATION

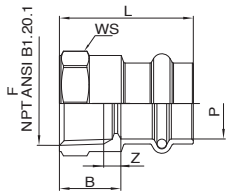

FNW5V0176

Brass Female Thread Adapter

Size (in.) P x F	FNW Code	Bag Qty.	Weight (lbs)	L1	B	Z	WS
1/2" x 3/8"	FNW5V0176DC	10	0.08	1.3	0.59	0.19	0.79
1/2" x 1/2"	FNW5V0176D	10	0.128	1.48	0.77	0.23	0.98
1/2" x 3/4"	FNW5V0176DF	10	0.154	1.54	0.83	0.28	1.22
3/4" x 1/2"	FNW5V0176FD	10	0.169	1.75	0.85	0.31	0.98
3/4" x 3/4"	FNW5V0176F	10	0.176	1.67	0.77	0.22	1.22
1" x 1/2"	FNW5V0176GD	10	0.19	1.85	0.91	0.37	0.98
1" x 3/4"	FNW5V0176GF	10	0.230	1.81	0.87	0.31	1.22
1" x 1"	FNW5V0176G	10	0.277	1.87	0.93	0.26	1.5
1" x 1-1/4"	FNW5V0176GH	5	0.457	2.07	1.12	0.44	1.89
1-1/4" x 1"	FNW5V0176HG	1	0.422	2.02	0.99	0.33	1.89
1-1/4" x 1-1/4"	FNW5V0176H	1	0.441	2.07	1.04	0.36	1.89
1-1/4" x 1-1/2"	FNW5V0176HJ	1	0.469	2.05	1.02	0.33	2.13
1-1/2" x 1-1/4"	FNW5V0176JH	1	0.567	2.44	1.02	0.33	1.89
1-1/2" x 1-1/2"	FNW5V0176J	1	0.571	2.41	1.00	0.28	2.13
2" x 2"	FNW5V0176K	1	0.812	2.56	0.98	0.29	2.64

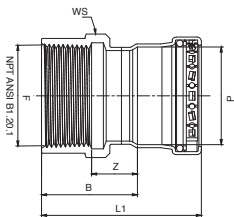

FNW5V0176 - XLC

Copper Female Thread Adapter

Size (in.) P x F	FNW Code	Bag Qty.	Weight (lbs)	L1	B	Z	WS
2-1/2" x 2-1/2"	FNW5V0176L	1	2.079	4.33	2.6	1.24	3.19
3" x 3"	FNW5V0176M	1	3.224	4.76	2.8	1.4	3.94
4" x 4"	FNW5V0176P	1	4.769	5.33	2.93	1.4	4.92

DIMENSIONAL INFORMATION

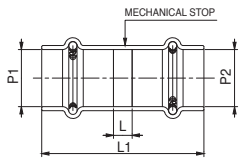
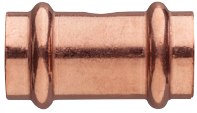

FNW5V0276

P x P COUPLING W/ST

Size (in.)	FNW Code	Bag Qty.	Weight (lbs)	L	L1
P1 x P2					
1/2" x 1/2"	FNW5V0276D	10	0.079	0.12	1.61
3/4" x 3/4"	FNW5V0276F	10	0.139	0.16	1.97
1" x 1"	FNW5V0276G	5	0.176	0.16	1.97
1-1/4" x 1-1/4"	FNW5V0276H	5	0.223	0.16	2.2
1-1/2" x 1-1/2"	FNW5V0276J	1	0.471	0.16	2.99
2" x 2"	FNW5V0276K	1	0.582	0.16	3.31

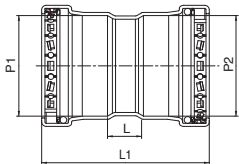
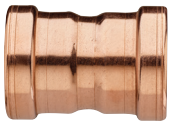

FNW5V0276 - XLC

P x P XLC COUPLING W/ST

Size (in.)	FNW Code	Bag Qty.	Weight (lbs)	L1	B
P1 x P2					
2-1/2" x 2-1/2"	FNW5V0276L	1	1.27	0.87	4.33
3" x 3"	FNW5V0276M	1	1.824	0.98	4.92
4" x 4"	FNW5V0276P	1	3.086	1.02	5.83

DIMENSIONAL INFORMATION

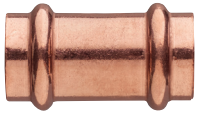

FNW5V0576

Coupling L/ST

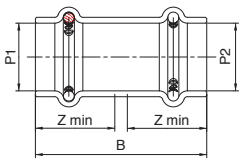

Size (in.) P1 x P2	FNW Code	Bag Qty.	Weight (lbs)	B	Z min
1/2" x 1/2"	FNW5V0576D	10	0.079	1.61	0.75
3/4" x 3/4"	FNW5V0576F	10	0.139	1.97	0.91
1" x 1"	FNW5V0576G	5	0.176	1.97	0.91
1-1/4" x 1-1/4"	FNW5V0576H	5	0.223	2.2	1.02
1-1/2" x 1-1/2"	FNW5V0576J	1	0.471	2.99	1.42
2" x 2"	FNW5V0576K	1	0.582	3.31	1.57



FNW5V0576 - XLC

Coupling L/ST

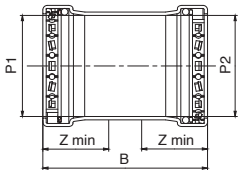

Size (in.) P1 x P2	FNW Code	Bag Qty.	Weight (lbs)	B	Z min
2-1/2" x 2-1/2"	FNW5V0576L	1	1.336	4.33	1.73
3" x 3"	FNW5V0576M	1	1.811	4.92	1.97
4" x 4"	FNW5V0576P	1	3.062	5.83	2.4



FNW5V7676

P x P EXT Coupling L/ST

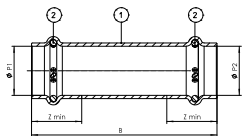

Size (in.) P1 x P2	FNW Code	Bag Qty.	Weight (lbs)	B	Z min
1/2"	FNW5V7676D	5	0.127	3	0.7
3/4"	FNW5V7676F	5	0.21	3.3	0.9
1"	FNW5V7676G	5	0.29	3.7	0.9

DIMENSIONAL INFORMATION

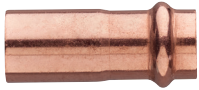

FNW5V0476

FTG x P Reducer

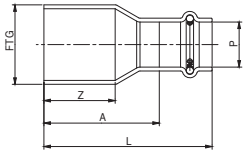

Size (in.)	FNW Code	Bag Qty.	Weight (lbs)	Z	A	L
3/4" x 1/2"	FNW5V0476FD	10	0.098	1.02	1.42	2.17
1" x 1/2"	FNW5V0476GD	10	0.141	1.02	1.65	2.4
1" x 3/4"	FNW5V0476GF	5	0.166	1.02	1.34	2.24
1-1/4" x 1/2"	FNW5V0476HD	5	0.174	1.1	1.81	2.56
1-1/4" x 3/4"	FNW5V0476HF	5	0.217	1.1	1.63	2.54
1-1/4" x 1"	FNW5V0476HG	5	0.218	1.1	1.42	2.32
1-1/2" x 1/2"	FNW5V0476JD	5	0.286	2.91	2.2	1.69
1-1/2" x 3/4"	FNW5V0476JF	1	0.288	1.5	2.24	3.15
1-1/2" x 1"	FNW5V0476JG	1	0.31	1.5	2.07	2.97
1-1/2" x 1-1/4"	FNW5V0476JH	1	0.303	1.5	1.85	2.87
2" x 1/2"	FNW5V0476KD	1	0.443	1.97	2.7	3.41
2" x 3/4"	FNW5V0476KF	1	0.469	3.58	2.68	1.97
2" x 1"	FNW5V0476KG	1	0.417	1.65	2.6	3.5
2" x 1-1/4"	FNW5V0476KH	1	0.429	1.65	2.4	3.43
2" x 1-1/2"	FNW5V0476KJ	1	0.601	1.65	2.2	3.62
2-1/2" x 1"	FNW5V0476LG	1	0.78	1.97	3.39	4.29
2-1/2" x 1-1/4"	FNW5V0476LH	1	0.745	1.97	3.27	4.29
2-1/2" x 1-1/2"	FNW5V0476LJ	1	0.849	1.97	3.15	4.57
2-1/2" x 2"	FNW5V0476LK	1	0.744	1.97	2.87	4.45
3" x 1-1/4"	FNW5V0476MH	1	1.014	2.28	3.82	4.84
3" x 1-1/2"	FNW5V0476MJ	1	1.239	2.28	3.7	5.12
3" x 2"	FNW5V0476MK	1	1.276	2.28	3.46	5.04
4" x 2"	FNW5V0476PK	1	2.029	2.56	4.21	5.79

DIMENSIONAL INFORMATION

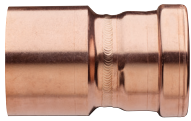

FNW5V0476 - XLC

FTG x P Reducer

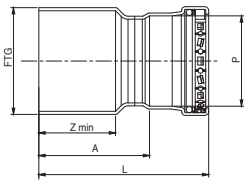

Size (in.)	FNW Code	Bag Qty.	Weight (lbs)	A	L	Z min
FTG x P						
3" x 2-1/2"	FNW5V0476ML	1	1.529	2.28	3.23	4.96
4" x 2-1/2"	FNW5V0476PL	1	2.275	2.56	4.02	5.75
4" x 3"	FNW5V0476PM	1	2.436	2.56	3.86	5.83

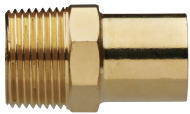

FNW5V0876

FTG x M Adaptor

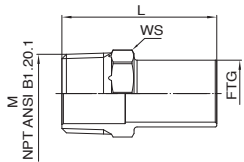

Size (in.)	FNW Code	Bag Qty.	Weight (lbs)	L	WS
FTG x M					
1/2" x 1/2"	FNW5V0876D	5	0.11	1.83	0.87
1/2" x 3/4"	FNW5V0876DF	5	0.129	1.87	1.06
3/4" x 1/2"	FNW5V0876FD	5	0.154	2.01	1.06
3/4" x 3/4"	FNW5V0876F	5	0.176	2.03	1.06
1" x 1"	FNW5V0876G	5	0.267	2.28	1.34
1-1/4" x 1-1/4"	FNW5V0876H	1	0.535	2.6	1.89
1-1/2" x 1-1/2"	FNW5V0876J	1	0.712	3.05	2.13
2" x 2"	FNW5V0876K	1	1.082	3.37	2.64

DIMENSIONAL INFORMATION

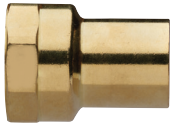

FNW5V0976

FTG x F Adaptor

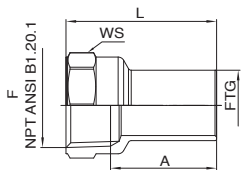

Size (in.)	FNW Code	Bag Qty.	Weight (lbs)	L	A	WS
FTG x F						
1/2" x 1/2"	FNW5V0976D	5	0.106	1.71	1.18	0.98
1/2" x 3/4"	FNW5V0976DF	5	1.461	1.79	1.24	1.22
3/4" x 1/2"	FNW5V0976FD	5	0.129	1.82	1.28	0.98
3/4" x 3/4"	FNW5V0976F	5	0.16	1.87	1.32	1.22
1" x 1"	FNW5V0976G	1	0.253	2.03	1.37	1.5
1-1/4" x 1-1/4"	FNW5V0976H	1	0.427	2.34	1.66	1.89
1-1/2" x 1-1/2"	FNW5V0976J	1	0.604	2.68	2	2.13
2" x 2"	FNW5V0976K	1	0.882	2.87	2.18	2.64



FNW5V1176

P x F 90 DEG Elbow

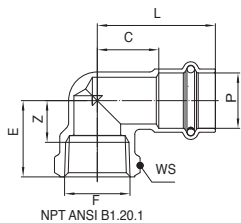

Size (in.)	FNW Code	Bag Qty.	Weight (lbs)	L	C	E	Z	WS
P x F								
1/2" x 1/2"	FNW5V1176D	5	0.172	1.57	0.87	1.12	0.59	1.02
3/4" x 3/4"	FNW5V1176F	5	0.268	1.89	0.98	1.22	0.67	1.22
1" x 1"	FNW5V1176G	1	0.47	2.17	1.22	1.46	0.8	1.5
1-1/4" x 1-1/4"	FNW5V1176H	1	0.774	2.48	1.46	1.65	0.98	1.89
1-1/2" x 1-1/2"	FNW5V1176J	1	1.131	3.07	1.65	1.85	1.18	2.13
2" x 2"	FNW5V1176K	1	1.796	3.54	1.97	2.2	1.52	2.64

DIMENSIONAL INFORMATION

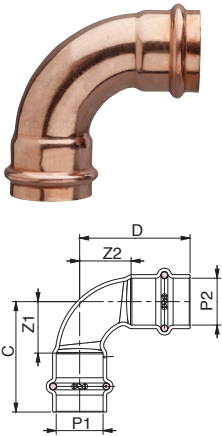

FNW5V1276

P x P 90 DEG Elbow

Size (in.) P1 x P2	FNW Code	Bag Qty.	Weight (lbs)	Z1	C	Z2	D
1/2" x 1/2"	FNW5V1276D	10	0.111	0.63	1.38	0.63	1.38
3/4" x 3/4"	FNW5V1276F	10	0.168	0.76	1.66	0.76	1.65
1" x 1"	FNW5V1276G	5	0.234	0.99	1.90	0.99	1.90
1-1/4" x 1-1/4"	FNW5V1276H	5	0.346	1.28	2.30	1.28	2.30
1-1/2" x 1-1/2"	FNW5V1276J	1	0.653	1.43	2.83	1.42	2.83
2" x 2"	FNW5V1276K	1	1.008	2.01	3.58	2.01	3.58

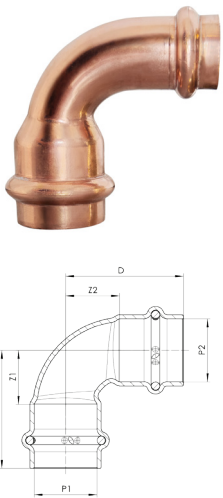

FNW5V1276

P x P 90 Reducing Elbow

Size (in.) P1 x P2	FNW Code	Bag Qty.	Weight (lbs)	Z1	C	Z2	D
3/4" x 1/2"	FNW5V1276FD	15	0.16	0.9	1.8	0.9	1.7
1" x 3/4"	FNW5V1276GF	10	0.256	1.2	2.1	1.2	2.1

DIMENSIONAL INFORMATION

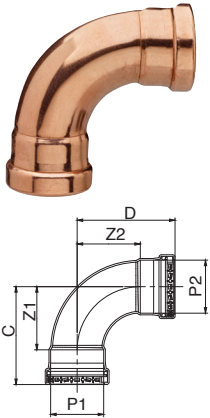

FNW5V1276 - XLC

P x P 90 DEG Elbow

Size (in.)	FNW Code	Bag Qty.	Weight (lbs)	Z1	C	Z2	D
P1 x P2							
2-1/2" x 2-1/2"	FNW5V1276L	1	2.275	3.15	4.88	3.15	4.88
3" x 3"	FNW5V1276M	1	3.266	3.74	5.71	3.74	5.71
4" x 4"	FNW5V1276P	1	5.971	4.84	7.24	4.84	7.24

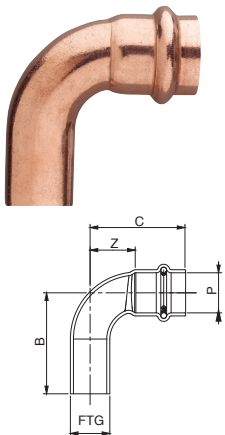

FNW5V1376

FTG x P ST 90 DEG Elbow

Size (in.)	FNW Code	Bag Qty.	Weight (lbs)	B	Z	C
FTG x P						
1/2" x 1/2"	FNW5V1376D	10	0.094	1.42	0.63	1.38
3/4" x 3/4"	FNW5V1376F	10	0.172	1.85	0.79	1.69
1" x 1"	FNW5V1376G	5	0.227	2.09	1.02	1.93
1-1/4" x 1-1/4"	FNW5V1376H	5	0.344	2.46	1.3	2.32
1-1/2" x 1-1/2"	FNW5V1376J	1	0.628	3.07	1.47	2.87
2" x 2"	FNW5V1376K	1	0.989	3.76	2.03	3.6

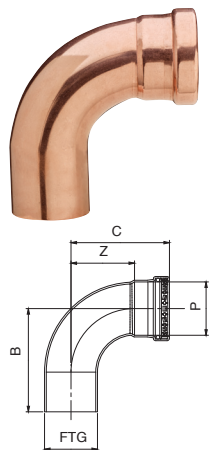

FNW5V1376 - XLC

XLC FTG x P ST 90 DEG Elbow

Size (in.)	FNW Code	Bag Qty.	Weight (lbs)	B	Z	C
FTG x P						
2-1/2" x 2-1/2"	FNW5V1376L	1	2.178	5.12	3.15	4.88
3" x 3"	FNW5V1376M	1	3.163	6.02	3.74	5.71
4" x 4"	FNW5V1376P	1	5.855	7.52	4.96	7.36

NOTE: All weights are in pounds and all dimensions are in inches.

DIMENSIONAL INFORMATION

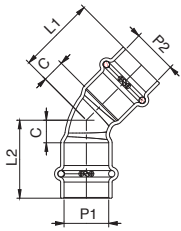

FNW5V1476

P x P 45 DEG Elbow

Size (in.) P1 x P2	FNW Code	Bag Qty.	Weight (lbs)	C	L1	L2
1/2" x 1/2"	FNW5V1476D	10	0.099	0.31	1.06	1.06
3/4" x 3/4"	FNW5V1476F	10	0.157	0.36	1.26	1.26
1" x 1"	FNW5V1476G	5	0.195	0.46	1.36	1.36
1-1/4" x 1-1/4"	FNW5V1476H	5	0.27	0.57	1.59	1.59
1-1/2" x 1-1/2"	FNW5V1476J	1	0.548	0.67	2.09	2.09
2" x 2"	FNW5V1476K	1	0.749	0.88	2.46	2.46

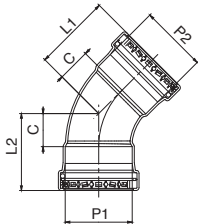

FNW5V1476 - XLC

XLC P x P 45 DEG Elbow

Size (in.) P1 x P2	FNW Code	Bag Qty.	Weight (lbs)	C	L1	L2
2-1/2" x 2-1/2"	FNW5V1476L	1	1.696	1.3	3.03	3.03
3" x 3"	FNW5V1476M	1	2.404	1.57	3.54	3.54
4" x 4"	FNW5V1476P	1	4.354	2.05	4.45	4.45

DIMENSIONAL INFORMATION

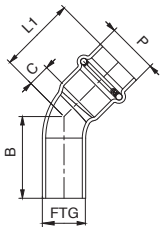

FNW5V1576

FTG x P ST 45 DEG Elbow

Size (in.) FTG x P	FNW Code	Bag Qty.	Weight (lbs)	B	C	L1
1/2" x 1/2"	FNW5V1576D	10	0.075	1.1	0.31	1.06
3/4" x 3/4"	FNW5V1576F	10	0.146	1.38	0.36	1.26
1" x 1"	FNW5V1576G	5	0.181	1.48	0.46	1.36
1-1/4" x 1-1/4"	FNW5V1576H	5	0.254	1.67	0.57	1.59
1-1/2" x 1-1/2"	FNW5V1576J	1	0.51	2.17	0.67	2.09
2" x 2"	FNW5V1576K	1	0.686	2.54	0.88	2.46

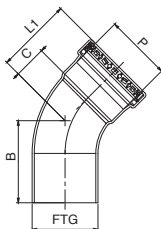

FNW5V1576 - XLC

XLC FTG x P ST 45 DEG Elbow

Size (in.) FTG x P	FNW Code	Bag Qty.	Weight (lbs)	B	C	L1
2-1/2" x 2-1/2"	FNW5V1576L	1	1.598	3.3	1.3	3
3" x 3"	FNW5V1576M	1	2.301	3.9	1.6	3.5
4" x 4"	FNW5V1576P	1	4.151	4.6	2	4.4

DIMENSIONAL INFORMATION

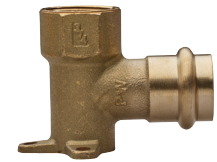

FNW5V2076

P x F Brass 90 DEG Elbow w/wall plate

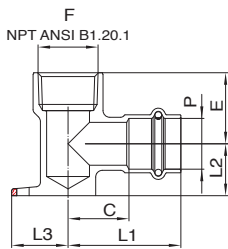

Size (in.) P x F	FNW Code	Bag Qty.	Weight (lbs)	L1	E	L2	L3	C
1/2" x 1/2"	FNW5V2076D	5	0.243	1.57	1	0.79	0.98	0.87
3/4" x 3/4"	FNW5V2076F	5	0.391	1.97	1.24	0.91	0.98	1.06

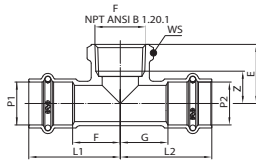

FNW5V3176

Brass P x P x F Tee

Size (in.) P1 x P2 x F	FNW Code	Bag Qty.	Weight (lbs)	L1	L2	F	G	E	Z	WS
1/2" x 1/2" x 1/2"	FNW5V3176D	5	0.233	1.57	1.57	0.87	0.87	1.12	0.59	1.02
3/4" x 3/4" x 1/4"	FNW5V3176FFB	5	0.367	1.76	1.76	0.86	0.86	1.2	0.81	1.02
3/4" x 3/4" x 1/2"	FNW5V3176FFD	5	0.329	1.76	1.76	0.86	0.86	1.2	0.65	1.02
3/4" x 3/4" x 3/4"	FNW5V3176F	5	0.367	1.89	1.89	0.98	0.98	1.22	0.67	1.22
1" x 1" x 1/2"	FNW5V3176GGD	5	0.448	1.83	1.83	0.89	0.89	1.36	0.83	1.02
1" x 1" x 3/4"	FNW5V3176GGF	5	0.502	1.97	1.97	1.02	1.02	1.4	0.85	1.22
1-1/4" x 1-1/4" x 1/2"	FNW5V3176HHD	1	0.6	1.85	1.85	0.83	0.83	1.59	1.06	1.02
1-1/4" x 1-1/4" x 3/4"	FNW5V3176HHF	1	0.643	1.91	1.91	0.89	0.89	1.61	1.06	1.22
1-1/2" x 1-1/2" x 1/2"	FNW5V3176JJD	1	0.951	2.24	2.24	0.83	0.83	1.77	1.24	1.02
1-1/2" x 1-1/2" x 3/4"	FNW5V3176JJF	1	0.99	2.28	2.28	0.87	0.87	1.85	1.3	1.22
2" x 2" x 1/2"	FNW5V3176KKD	1	1.36	2.5	2.5	0.93	0.93	2.05	1.51	1.02
2" x 2" x 3/4"	FNW5V3176KKF	1	1.423	2.56	2.56	0.98	0.98	2.09	1.54	1.22

DIMENSIONAL INFORMATION

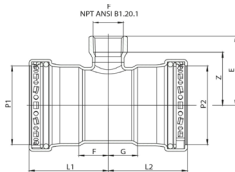

FNW5V3176 - XLC

Copper P x P x F Tee XLC

Size (in.) P1 x P2 x F	FNW Code	Bag Qty.	Weight (lbs)	L1	L2	F	G	E	Z	WS
2-1/2" x 2-1/2" x 3/4"	FNW5V3176LLF	1	1.658	2.76	2.76	1.02	1.02	2.4	1.85	1.2
3" x 3" x 3/4"	FNW5V3176MMF	1	2.163	3.03	3.03	1.06	1.06	2.64	2.09	1.2
4" x 4" x 3/4"	FNW5V3176PPF	1	3.483	3.46	3.46	1.06	1.06	3.11	2.56	1.2

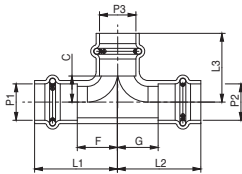
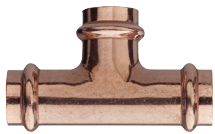

FNW5V3276

P x P x P Tee

Size (in.) P1 x P2 x P3	FNW Code	Bag Qty.	Weight (lbs)	L1	F	L2	G	L3	C
1/2" x 1/2" x 1/2"	FNW5V3276D	10	0.224	1.46	0.71	1.46	0.71	1.2	0.46
3/4" x 3/4" x 3/4"	FNW5V3276F	5	0.329	1.69	0.79	1.69	0.79	1.46	0.55
1" x 1" x 1"	FNW5V3276G	5	0.472	1.77	0.87	1.77	0.87	1.57	0.67
1-1/4" x 1-1/4" x 1-1/4"	FNW5V3276H	1	0.612	2.01	0.98	2.01	0.98	1.85	0.83
1-1/2" x 1-1/2" x 1-1/2"	FNW5V3276J	1	1.206	2.56	1.14	2.56	1.14	2.56	1.14
2" x 2" x 2"	FNW5V3276K	1	1.508	2.83	1.26	2.83	1.26	2.83	1.26

DIMENSIONAL INFORMATION

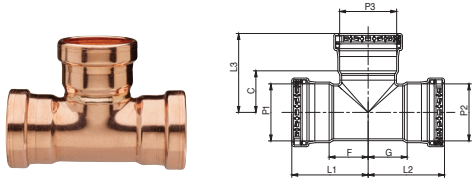

FNW5V3276 - XLC

XLC P x P x P Tee

Size (in.) P1 x P2 x P3	FNW Code	Bag Qty.	Weight (lbs)	L1	F	L2	G	L3	C
2-1/2" x 2-1/2" x 2-1/2"	FNW5V3276L	1	2.628	3.54	1.81	3.54	1.81	3.66	1.93
3" x 3" x 3"	FNW5V3276M	1	3.61	4.06	2.09	4.06	2.09	4.21	2.24
4" x 4" x 4"	FNW5V3276P	1	6.379	4.96	2.56	4.96	2.56	5.12	2.72

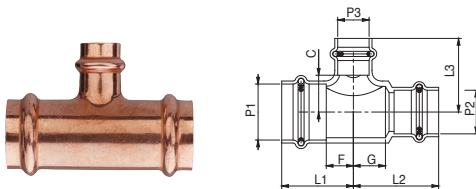

FNW5V3376

P x P x P Reducing Tee

Size (in.) P1 x P2 x P3	FNW Code	Bag Qty.	Weight (lbs)	L1	F	L2	G	L3	C
3/4" x 3/4" x 1/2"	FNW5V3376FFD	5	0.256	1.42	0.51	1.42	0.51	1.38	0.63
1" x 1" x 1/2"	FNW5V3376GGD	5	0.349	1.46	0.55	1.46	0.55	1.5	0.75
1" x 1" x 3/4"	FNW5V3376GGF	5	0.42	1.63	0.73	1.63	0.73	1.57	0.67
1-1/4" x 1-1/4" x 1/2"	FNW5V3376HHD	1	0.445	1.65	0.63	1.65	0.63	1.61	0.87
1-1/4" x 1-1/4" x 3/4"	FNW5V3376HHF	1	0.465	1.65	0.63	1.65	0.63	1.73	0.83
1-1/4" x 1-1/4" x 1"	FNW5V3376HHG	1	0.53	1.85	0.81	1.85	0.81	1.73	0.83
1-1/2" x 1-1/2" x 1/2"	FNW5V3376JJD	1	0.711	2.56	1.14	2.56	1.14	2.17	1.42
1-1/2" x 1-1/2" x 3/4"	FNW5V3376JJF	1	0.805	2.56	1.14	2.56	1.14	2.28	1.38
1-1/2" x 1-1/2" x 1"	FNW5V3376JJG	1	0.932	2.56	1.14	2.56	1.14	2.28	1.38
1-1/2" x 1-1/2" x 1-1/4"	FNW5V3376JJH	1	1.024	2.56	1.14	2.56	1.14	2.4	1.38
2" x 2" x 1/2"	FNW5V3376KKD	1	0.916	2.83	1.26	2.83	1.26	2.4	1.65
2" x 2" x 3/4"	FNW5V3376KKF	1	1.032	2.83	1.26	2.83	1.26	2.52	1.61
2" x 2" x 1"	FNW5V3376KKG	1	1.116	2.83	1.26	2.83	1.26	2.52	1.61
2" x 2" x 1-1/4"	FNW5V3376KKH	1	1.254	2.83	1.26	2.83	1.26	2.64	1.61
2" x 2" x 1-1/2"	FNW5V3376KKJ	1	1.419	2.83	1.26	2.83	1.26	3.03	1.61

DIMENSIONAL INFORMATION

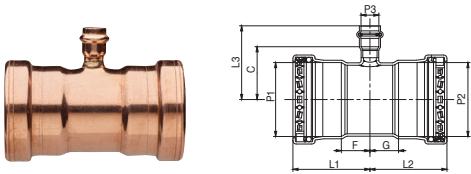

FNW5V3376 - XLC

P x P x P Reducing Tee

Size (in.)	FNW Code	Bag Qty.	Weight (lbs)	L1	F	L2	G	L3	C
P1 x P2 x P3									
2-1/2" x 2-1/2" x 1/2"	FNW5V3376LLD	1	1.674	2.76	1.02	2.76	1.02	2.64	1.89
2-1/2" x 2-1/2" x 3/4"	FNW5V3376LLF	1	1.705	2.76	1.02	2.76	1.02	2.80	1.89
2-1/2" x 2-1/2" x 1"	FNW5V3376LLG	1	1.728	2.76	1.02	2.76	1.02	2.80	1.89
2-1/2" x 2-1/2" x 1-1/4"	FNW5V3376LLH	1	1.961	3.23	1.50	3.23	1.50	2.91	1.89
2-1/2" x 2-1/2" x 1-1/2"	FNW5V3376LLJ	1	2.101	3.23	1.50	3.23	1.50	3.31	1.89
2-1/2" x 2-1/2" x 2"	FNW5V3376LLK	1	2.179	3.23	1.50	3.23	1.50	3.46	1.89
3" x 3" x 1/2"	FNW5V3376MMD	1	2.209	3.03	1.06	3.03	1.06	2.87	2.13
3" x 3" x 3/4"	FNW5V3376MMF	1	2.241	3.03	1.06	3.03	1.06	3.03	2.13
3" x 3" x 1"	FNW5V3376MMG	1	2.263	3.03	1.06	3.03	1.06	3.03	2.13
3" x 3" x 1-1/4"	FNW5V3376MMH	1	2.567	3.54	1.57	3.54	1.57	3.15	2.13
3" x 3" x 1-1/2"	FNW5V3376MMJ	1	2.707	3.54	1.57	3.54	1.57	3.54	2.13
3" x 3" x 2"	FNW5V3376MMK	1	2.786	3.54	1.57	3.54	1.57	3.70	2.13
4" x 4" x 1/2"	FNW5V3376PPD	1	3.859	3.46	1.06	3.46	1.06	3.35	2.60
4" x 4" x 3/4"	FNW5V3376PPF	1	3.89	3.46	1.06	3.46	1.06	3.50	2.60
4" x 4" x 1"	FNW5V3376PPG	1	3.912	3.46	1.06	3.46	1.06	3.50	2.60
4" x 4" x 1-1/4"	FNW5V3376PPH	1	4.11	3.98	1.57	3.98	1.57	3.62	2.60
4" x 4" x 1-1/2"	FNW5V3376PPJ	1	4.251	3.98	1.57	3.98	1.57	4.02	2.60
4" x 4" x 2"	FNW5V3376PPK	1	4.329	3.98	1.57	3.98	1.57	4.17	2.60

DIMENSIONAL INFORMATION

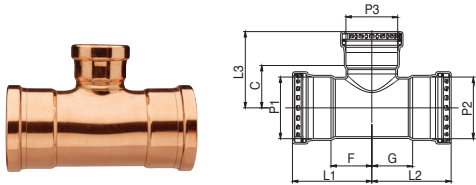

FNW5V3376 - XLC

P x P x P Reducing Tee

Size (in.) P1 x P2 x P3	FNW Code	Bag Qty.	Weight (lbs)	L1	F	L2	G	L3	C
3" x 3" x 2-1/2"	FNW5V3376MML	1	3.364	4.06	2.09	4.06	2.09	3.90	2.17
4" x 4" x 2-1/2"	FNW5V3376PPL	1	5.387	4.96	2.56	4.96	2.56	4.37	2.64
4" x 4" x 3"	FNW5V3376PPM	1	5.633	4.96	2.56	4.96	2.56	4.69	2.72

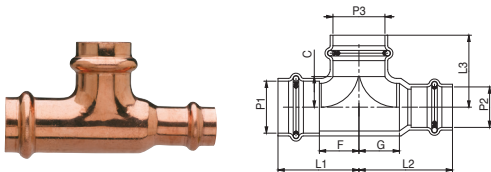

FNW5V3476

P x P x P Reducing Tee

Size (in.) P1 x P2 x P3	FNW Code	Bag Qty.	Weight (lbs)	L1	F	L2	G	L3	C
3/4" x 1/2" x 3/4"	FNW5V3476FDF	5	0.319	1.69	0.79	1.69	0.94	1.46	0.55
1" x 1/2" x 1"	FNW5V3476GDG	5	0.461	1.77	0.87	2.05	1.3	1.57	0.67
1" x 3/4" x 1"	FNW5V3476GFG	5	0.479	1.77	0.87	2.05	1.14	1.57	0.67
1-1/4" x 1/2" x 1-1/4"	FNW5V3476HDH	1	0.595	2.01	0.98	2.48	1.73	1.85	0.83
1-1/4" x 3/4" x 1-1/4"	FNW5V3476HFH	1	0.615	2.01	0.98	2.48	1.73	1.85	0.83
1-1/2" x 1" x 1-1/2"	FNW5V3476JGJ	1	1.123	2.56	1.14	2.6	1.69	2.56	1.14
2" x 1-1/2" x 2"	FNW5V3476KJK	1	1.574	2.83	1.26	3.39	1.97	2.83	1.26

DIMENSIONAL INFORMATION

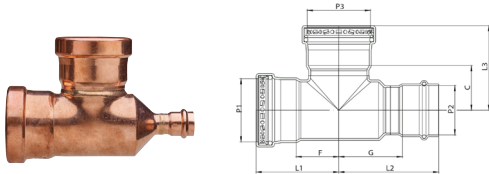

FNW5V3476 - XLC

P x P x P Reducing Tee XLC

Size (in.) P1 x P2 x P3	FNW Code	Bag Qty.	Weight (lbs)	L1	F	L2	G	L3	C
2-1/2" x 3/4" x 2-1/2"	FNW5V3476LFL	1	2.233	3.58	1.85	4.13	3.23	4.06	2.32
2-1/2" x 1" x 2-1/2"	FNW5V3476LGL	1	2.235	3.58	1.85	4.17	3.27	4.06	2.32
2-1/2" x 1-1/4" x 2-1/2"	FNW5V3476LHL	1	2.268	3.58	1.85	4.21	3.19	4.06	2.32
2-1/2" x 1-1/2" x 2-1/2"	FNW5V3476LJL	1	2.416	3.58	1.85	4.57	3.15	4.13	2.4
2-1/2" x 2" x 2-1/2"	FNW5V3476LKL	1	2.427	3.58	1.85	3.98	2.4	4.09	2.36
3" x 3/4" x 3"	FNW5V3476MFM	1	3.058	4.06	2.09	4.72	3.82	4.65	2.68
3" x 1" x 3"	FNW5V3476MGM	1	3.069	4.06	2.09	4.88	3.98	4.65	2.68
3" x 1-1/4" x 3"	FNW5V3476MHM	1	3.08	4.06	2.09	4.84	3.82	4.65	2.68
3" x 1-1/2" x 3"	FNW5V3476MJM	1	3.21	4.06	2.09	5.12	3.7	4.65	2.68
3" x 2" x 3"	FNW5V3476MKM	1	3.26	4.06	2.09	4.49	2.91	4.69	2.72
3" x 2-1/2" x 3"	FNW5V3476MLM	1	3.477	4.06	2.09	4.49	3.07	4.21	2.24

DIMENSIONAL INFORMATION

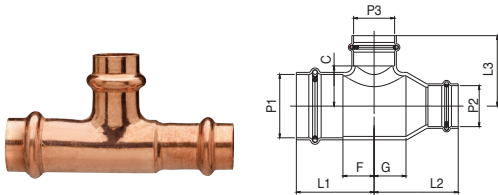

FNW5V3576
P x P x P Reducing Tee

Size (in.) P1 x P2 x P3	FNW Code	Bag Qty.	Weight (lbs)	L1	F	L2	G	L3	C
3/4" x 1/2" x 1/2"	FNW5V3576FDD	5	0.243	1.42	0.51	1.42	0.67	1.38	0.63
1" x 3/4" x 3/4"	FNW5V3576GFF	5	0.425	1.63	0.73	1.91	1.00	1.57	0.67
1-1/4" x 3/4" x 3/4"	FNW5V3576HFF	1	0.467	1.65	0.63	2.05	1.14	1.69	0.79
1-1/4" x 1" x 1"	FNW5V3576HGG	1	0.537	1.85	0.83	2.01	1.08	1.73	0.83
1-1/2" x 1" x 1"	FNW5V3576JGG	1	0.849	2.56	1.14	2.68	1.77	2.28	1.38
1-1/2" x 1-1/4" x 1-1/4"	FNW5V3576JHH	1	0.946	2.56	1.14	2.68	1.65	2.40	1.38
2" x 1-1/4" x 1-1/4"	FNW5V3576KHH	1	1.175	2.83	1.26	3.35	2.32	2.68	1.65
2" x 1-1/2" x 1-1/2"	FNW5V3576KJJ	1	1.449	2.83	1.26	3.35	1.93	3.11	1.69

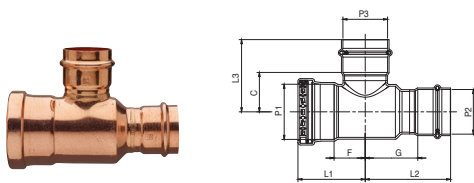

FNW5V3576 - XLC
P x P x P Reducing Tee

Size (in.) P1 x P2 x P3	FNW Code	Bag Qty.	Weight (lbs)	L1	F	L2	G	L3	C
2-1/2" x 2" x 2"	FNW5V3576LKK	1	2.015	3.23	1.50	3.82	2.24	3.74	2.17
3" x 2" x 2"	FNW5V3576MKK	1	2.722	3.54	1.57	4.25	2.68	4.02	2.44
3" x 2-1/2" x 2-1/2"	FNW5V3576MLL	1	3.122	3.82	1.85	4.57	2.83	3.90	2.17
4" x 3" x 3"	FNW5V3576PMM	1	4.987	4.53	2.13	5.43	3.46	4.69	2.72

DIMENSIONAL INFORMATION

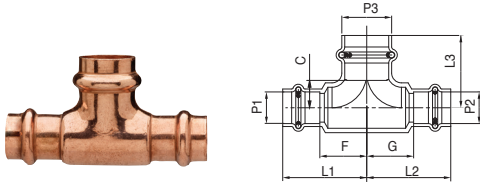

FNW5V3676

P x P x P Reducing Tee

Size (in.) P1 x P2 x P3	FNW Code	Bag Qty.	Weight (lbs)	L1	F	L2	G	L3	C
1/2" x 1/2" x 3/4"	FNW5V3676DDDF	5	0.31	1.85	1.1	1.85	1.1	1.46	0.55
1/2" x 1/2" x 1"	FNW5V3676DDDG	5	0.45	2.13	1.38	2.13	1.38	1.57	0.67
3/4" x 3/4" x 1"	FNW5V3676FFFG	5	0.485	2.09	1.18	2.09	1.18	1.57	0.67
1" x 1" x 1-1/4"	FNW5V3676GGH	1	0.632	2.28	1.38	2.28	1.38	1.85	0.83

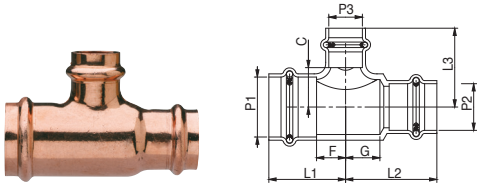

FNW5V4776

P x P x P Reducing Tee

Size (in.) P1 x P2 x P3	FNW Code	Bag Qty.	Weight (lbs)	L1	F	L2	G	L3	C
1" x 1/2" x 3/4"	FNW5V4776GDF	5	0.408	1.63	0.77	1.91	1.16	1.57	0.67
1" x 3/4" x 1/2"	FNW5V4776GFD	5	0.358	1.46	0.55	1.73	0.83	1.50	0.75
1-1/4" x 3/4" x 1"	FNW5V4776HFG	1	0.538	1.83	0.81	2.28	1.38	1.69	0.79
1-1/4" x 1" x 1/2"	FNW5V4776HGD	1	0.448	1.65	0.63	1.85	0.94	1.61	0.87
1-1/4" x 1" x 3/4"	FNW5V4776HGF	1	0.463	1.65	0.63	1.81	0.91	1.73	0.83
1-1/2" x 1" x 3/4"	FNW5V4776JGF	1	0.723	2.56	1.14	2.68	1.77	2.28	1.38
1-1/2" x 1-1/4" x 3/4"	FNW5V4776JHF	1	0.782	2.56	1.14	2.68	1.65	2.28	1.38
1-1/2" x 1-1/4" x 1"	FNW5V4776JHG	1	0.769	2.56	1.14	2.68	1.65	2.28	1.38
2" x 1-1/2" x 3/4"	FNW5V4776KJF	1	1.054	2.83	1.26	3.35	1.93	2.56	1.65
2" x 1-1/2" x 1"	FNW5V4776KJG	1	1.054	2.83	1.26	3.35	1.93	2.56	1.65
2" x 1-1/2" x 1-1/4"	FNW5V4776KJH	1	1.285	2.83	1.26	3.35	1.93	2.68	1.65

DIMENSIONAL INFORMATION

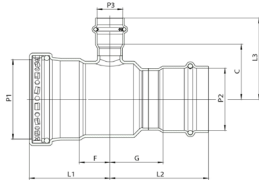

FNW5V4776 - XLC

P x P x P Reducing Tee XLC

Size (in.) P1 x P2 x P3	FNW Code	Bag Qty.	Weight (lbs)	L1	F	L2	G	L3	C
2-1/2" x 2" x 3/4"	FNW5V4776LKF	1	1.523	2.80	1.06	3.39	1.81	2.91	2.01
2-1/2" x 2" x 1"	FNW5V4776LKG	1	1.578	2.80	1.06	3.62	2.05	3.07	2.17
2-1/2" x 2" x 1-1/2"	FNW5V4776LKJ	1	1.847	3.03	1.30	3.86	2.28	3.58	2.17
3" x 2" x 2-1/2"	FNW5V4776MKL	1	2.892	3.54	1.57	4.29	2.56	4.02	2.28
3" x 2-1/2" x 2"	FNW5V4776MLK	1	2.7	3.82	1.85	4.53	2.95	4.33	2.76
4" x 3" x 2"	FNW5V4776PMK	1	4.096	4.02	1.61	5.31	3.35	4.53	2.95

DIMENSIONAL INFORMATION

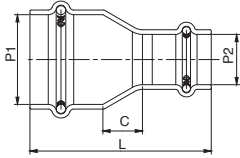
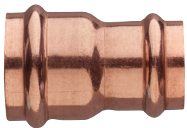

FNW5V4976

P x P Reducer

Size (in.) P1 x P2	FNW Code	Bag Qty.	Weight (lbs)	C	L
3/4" x 1/2"	FNW5V4976FD	10	0.118	0.43	2.09
1" x 1/2"	FNW5V4976GD	10	0.163	0.65	2.3
1" x 3/4"	FNW5V4976GF	5	0.15	0.47	2.28
1-1/4" x 3/4"	FNW5V4976HF	1	0.19	0.63	2.56
1-1/4" x 1"	FNW5V4976HG	1	0.25	0.55	2.48
1-1/2" x 3/4"	FNW5V4976JF	1	0.347	0.87	3.19
1-1/2" x 1"	FNW5V4976JG	1	0.35	0.67	2.99
1-1/2" x 1-1/4"	FNW5V4976JH	1	0.358	0.43	2.87
2" x 3/4"	FNW5V4976KF	1	0.484	1.3	3.78
2" x 1"	FNW5V4976KG	1	0.484	1.06	3.54
2" x 1-1/4"	FNW5V4976KH	1	0.491	0.83	3.43
2" x 1-1/2"	FNW5V4976KJ	1	0.695	0.75	3.74

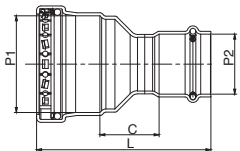
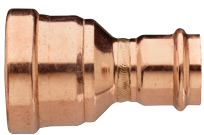

FNW5V4976 - XLC

XLC P x P Reducer

Size (in.) P1 x P2	FNW Code	Bag Qty.	Weight (lbs)	C	L
2-1/2" x 1"	FNW5V4976LG	1	0.943	1.89	4.53
2-1/2" x 1-1/4"	FNW5V4976LH	1	0.966	1.73	4.49
2-1/2" x 1-1/2"	FNW5V4976LJ	1	1.106	1.61	4.76
2-1/2" x 2"	FNW5V4976LK	1	1.125	1.38	4.69
3" x 1-1/2"	FNW5V4976MJ	1	1.431	1.89	5.28
3" x 2"	FNW5V4976MK	1	1.464	1.61	5.16
4" x 2"	FNW5V4976PK	1	2.388	2.13	6.1

DIMENSIONAL INFORMATION



FNW5V4976 - XLC 2

XLC P x P Reducer

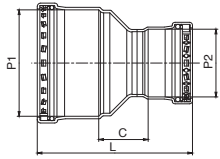

Size (in.)	FNW Code	Bag Qty.	Weight (lbs)	C	L
P1 x P2					
3" x 2-1/2"	FNW5V4976ML	1	1.712	1.42	5.12
4" x 2-1/2"	FNW5V4976PL	1	2.672	1.93	6.06
4" x 3"	FNW5V4976PM	1	2.869	1.77	6.14



FNW5V5376

End Cap

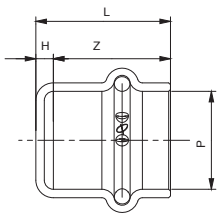

Size (in.)	FNW Code	Bag Qty.	Weight (lbs)	L	Z	H
P						
1/2"	FNW5V5376D	10	0.045	0.87	0.75	0.12
3/4"	FNW5V5376F	10	0.082	1.02	0.91	0.12
1"	FNW5V5376G	5	0.106	1.02	0.91	0.12
1-1/4"	FNW5V5376H	1	0.139	1.14	1.02	0.12
1-1/2"	FNW5V5376J	1	0.285	1.57	1.42	0.16
2"	FNW5V5376K	1	0.712	1.73	1.57	0.16



FNW5V5376 - XLC

XLC End Cap

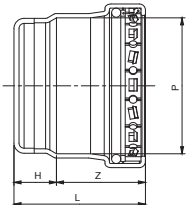

Size (in.)	FNW Code	Bag Qty.	Weight (lbs)	L	Z	H
P						
2-1/2"	FNW5V5376L	1	0.887	2.56	1.73	0.83
3"	FNW5V5376M	1	1.245	2.95	1.97	0.98
4"	FNW5V5376P	1	2.141	3.39	2.4	0.98

DIMENSIONAL INFORMATION

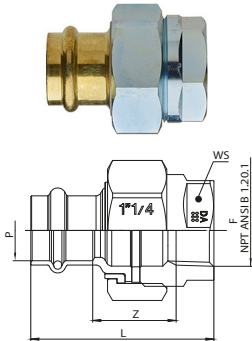

FNW5V4876

Brass P x FPT Dielectric Union

Size (in.) P1 x P2 x P3	FNW Code	Bag Qty.	Weight (lbs)	L1	F	L2
1/2"	FNW5V4876D	6	0.456	2.26	1.02	1.14
3/4"	FNW5V4876F	6	0.721	2.68	1.22	1.46
1"	FNW5V4876G	6	0.908	2.78	1.18	1.65
1-1/4"	FNW5V4876H	6	1.313	3.46	1.77	1.97
1-1/2"	FNW5V4876J	6	2.165	3.82	1.73	2.44
2"	FNW5V4876K	6	2.475	4.13	1.87	2.76

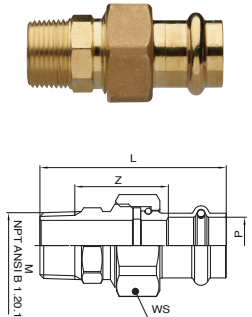

FNW5V5476

Brass P x M Union

Size (in.) P x M	FNW Code	Bag Qty.	Weight (lbs)	L	Z	WS
1/2" x 1/2"	FNW5V5476D	1	0.297	2.62	1.36	1.18
3/4" x 3/4"	FNW5V5476F	1	0.465	2.91	1.46	1.46
1" x 1"	FNW5V5476G	1	0.905	3.37	1.74	1.85
1-1/4" x 1-1/4"	FNW5V5476H	1	1.118	3.5	1.77	2.05
1-1/2" x 1-1/2"	FNW5V5476J	1	1.422	3.82	1.79	2.36
2" x 2"	FNW5V5476K	1	2.473	4.35	2.03	2.95

DIMENSIONAL INFORMATION

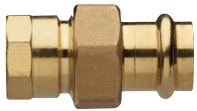

FNW5V5576

Brass P x F Union

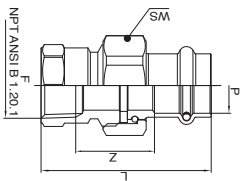

Size (in.) P x F	FNW Code	Bag Qty.	Weight (lbs)	L	Z	WS
1/2" x 1/2"	FNW5V5576D	1	0.28	2.36	1.12	1.18
3/4" x 3/4"	FNW5V5576F	1	0.47	2.72	1.26	1.46
1" x 1"	FNW5V5576G	1	0.737	2.72	1.11	1.85
1-1/4" x 1-1/4"	FNW5V5576H	1	1.068	3.25	1.54	2.05
1-1/2" x 1-1/2"	FNW5V5576J	1	1.286	3.4	1.42	2.36
2" x 2"	FNW5V5576K	1	2.047	3.76	1.49	2.95



FNW5V7476

Brass P x P Union

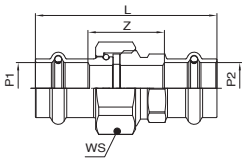

Size (in.) P x P	FNW Code	Bag Qty.	Weight (lbs)	L	Z	WS
1/2" x 1/2"	FNW5V7476D	1	0.279	2.74	1.32	1.18
3/4" x 3/4"	FNW5V7476F	1	0.46	3.13	1.32	1.46
1" x 1"	FNW5V7476G	1	0.795	3.39	1.5	1.85
1-1/4" x 1-1/4"	FNW5V7476H	1	1.024	3.79	1.74	2.05
1-1/2" x 1-1/2"	FNW5V7476J	1	1.348	4.17	1.46	2.36
2" x 2"	FNW5V7476K	1	2.517	4.84	1.69	2.95

DIMENSIONAL INFORMATION

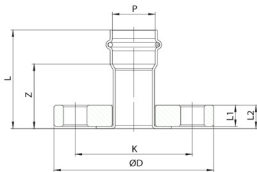
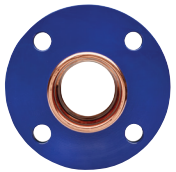

FNW5V5676

P x FLG Adaptor

Size (in.) P x FLG	FNW Code	Bag Qty.	Weight (lbs)	L	Z	L1	L2	ØD	Øm	K
1"	FNW5V5676G	1	2.14	2.61	1.71	0.56	0.62	4.25	0.63	3.12
1-1/4"	FNW5V5676H	1	2.765	2.66	1.64	0.62	0.68	4.61	0.63	3.5
1-1/2"	FNW5V5676J	1	3.759	3.29	1.87	0.69	0.77	5	0.63	3.88
2"	FNW5V5676K	1	5.662	3.56	1.98	0.71	0.82	5.98	0.75	4.75

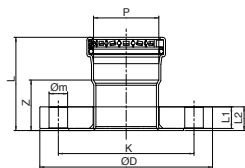
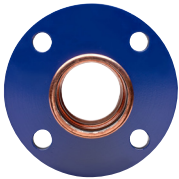

FNW5V5676 - XLC

P x FLG Adaptor

Size (in.) P x FLG	FNW Code	Bag Qty.	Weight (lbs)	L1	Z	L1	L2	ØD	Øm	K
2-1/2"	FNW5V5676L	1	7.068	2.83	1.1	0.63	0.71	7	0.75	5.5
3"	FNW5V5676M	1	9.513	3.19	1.22	0.75	0.83	7.5	0.75	4.94
4"	FNW5V5676P	1	13.448	3.7	1.3	0.75	0.83	9	0.75	7.5

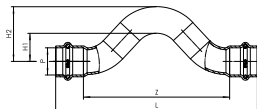

FNW5V6676

P x P Crossover

Size (in.) P x P	FNW Code	Bag Qty.	Weight (lbs)	L	Z	H1	H2
1/2"	FNW5V6676D	1	0.26	5.43	3.94	0.77	1.48
3/4"	FNW5V6676F	1	0.396	6.57	4.76	0.91	1.77

LIMITED WARRANTY

50-YEAR LIMITED WARRANTY FOR RESIDENTIAL AND COMMERCIAL APPLICATIONS

FNW Press-Joint Copper & Press-Joint Brass Fittings for Plumbing/Mechanical Applications

Subject to the terms and conditions of this Limited Warranty (“Warranty”), FNW warrants to the owner of the applicable real property in the United States that the FNW Press-Joint Copper and Brass press fittings for plumbing and mechanical applications (the “Product” or “Products”), shall be free from defects in material and workmanship, under normal conditions of use and service, for a period of FIFTY (50) years from the Warranty Commencement Date, when installed by a professional in accordance with applicable building codes and conventional commercial or residential building plumbing/mechanical systems and equipment.

Scope

The Term of Warranty begins on the Commencement Date, defined as the date of delivery to the initial purchaser. This Warranty is transferable during the warranty period to subsequent owners of the real property in which the Products are installed.

Claim Process and Remedies

In order to file a claim under the terms of this Warranty, a claimant must promptly notify FNW that a Product may be defective within 30 days of the suspected failure or defect via the telephone number, mail or website listed below.

- Telephone: 1-800-221-3379
- Mailing Address:
751 Lakefront Commons, Newport News, VA 23606
- Website: fnw.com

All Products alleged to be defective must be sent to FNW for inspection and testing for determination of the cause of the alleged defect or failure.

Exclusive Remedies

If FNW determines that a product identified above has failed or is defective within the scope of this Warranty, FNW’s liability hereunder is limited, at the option of FNW, to issue a refund of the purchase price or to repair or replace the defective product which is proved to be other than as warranted.

Conditions and Exclusions

In order for this Warranty to be in effect, the applicable FNW Products must be:

- Installed in accordance with the installation instructions provided by FNW;
- Installed by a professional in accordance with applicable building, mechanical, plumbing or other applicable code requirements and standard industry practice; and
- Installed in an end-use environment as intended for the Product.

In addition to the conditions above, this Warranty does not extend to product failure or resulting damages caused by:

1. Products, parts or systems not manufactured or sold by FNW;
2. Components, parts or systems used in conjunction with the Product;
3. Improper installation, inspection or testing of the Product in accordance with FNW’s written instructions or standard industry practice;
4. Natural disasters, including but not limited to flooding, fire, earthquake, windstorm and lightning
5. Misuse, tampering, mishandling or neglect of the Product;
6. Improper selection, application or other unauthorized use of the Product;
7. Modifications or unauthorized repairs to the Product;
8. Improper handling and storage of the Product prior to and during installation, including but not limited to inadequate freeze protection, exposure to water pressures or temperatures that exceed the limitations for the Product or in applications outside acceptable operating conditions indicated in the installation manual;
9. Exposure to abnormal external, physical or chemical conditions or abnormal operating conditions;
10. Product sold prior to the effective date of this Warranty; or
11. Any other cause beyond the control of the manufacturer.

COPPER PRESS SYSTEM

EFFECTIVE: DECEMBER 2021



LIMITED WARRANTY

DISCLAIMER OF WARRANTIES

THIS LIMITED WARRANTY IS THE FULL EXTENT OF EXPRESS WARRANTIES PROVIDED BY FNW, and FNW HEREBY DISCLAIMS ANY WARRANTY NOT EXPRESSLY PROVIDED HEREIN, INCLUDING, WITHOUT LIMITATION, THE IMPLIED WARRANTIES OF MERCHANTABILITY AND FITNESS FOR A PARTICULAR PURPOSE WITH RESPECT TO THE PRODUCTS COVERED HEREUNDER. FNW FURTHER DISCLAIMS ANY STATUTORY OR IMPLIED WARRANTY OF HABITABILITY.

FNW SHALL NOT BE LIABLE FOR PERSONAL INJURY OR PROPERTY DAMAGE OR ANY CONSEQUENTIAL, PUNITIVE OR INCIDENTAL DAMAGES. EXCEPT AS OTHERWISE EXPRESSLY STATED IN THIS LIMITED WARRANTY, FNW FURTHER DISCLAIMS ANY RESPONSIBILITY FOR LOSSES, EXPENSES, INCONVENIENCES, AND SPECIAL, INCIDENTAL OR CONSEQUENTIAL DAMAGES ARISING OR RESULTING IN ANY MANNER FROM THE PRODUCTS COVERED HEREUNDER. SOME STATES DO NOT ALLOW THE EXCLUSION OR LIMITATION OF INCIDENTAL OR CONSEQUENTIAL DAMAGES, OR LIMITATIONS ON HOW LONG AN IMPLIED WARRANTY LASTS, SO THE ABOVE LIMITATIONS OR EXCLUSIONS MAY NOT APPLY TO YOU.

THIS LIMITED WARRANTY GIVES THE CLAIMANT SPECIFIC LEGAL RIGHTS, AND YOU MAY ALSO HAVE OTHER RIGHTS WHICH VARY FROM STATE TO STATE.

LIABILITY UNDER THIS LIMITED WARRANTY IS SOLELY LIMITED TO THE REPAIR AND/OR REPLACEMENT OF THE PRESSFITTING THAT HAS BEEN DETERMINED BY FNW TO CONTAIN A DEFECT IN MATERIAL OR WORKMANSHIP.

Contact FNW Customer Service at 800-221-3379