

GUNTHER IN-WALL SHOWER DIVERTER TRIM

SKU: 953082
Code: SHGU9005



FEATURES

Required for Installation: Rough-in valve: SH6103 or SH6101

ASME A112.18.1/CSA B125.1, ASME A112.18.2/CSA B125.2, Massachusetts Accepted, LISTED ID: SHGU9005XX, SH6103



ADDITIONAL FEATURES

- Not intended as a shut off valve.
- Six total settings allow for shared water flow between outlets, giving you the ability to use two functions at once.
- Optional Rough-in Valve:
 - Available Single-Function Diverter Valve Cartridge restricts water flow to one outlet at a time.
 - Brass valve body.
 - Ceramic cartridge.
 - Must be installed in accordance with provided installation instructions.

REVISED 5/30/2024

GUNTHER IN-WALL SHOWER DIVERTER TRIM

SKU: 953082
Code: SHGU9005

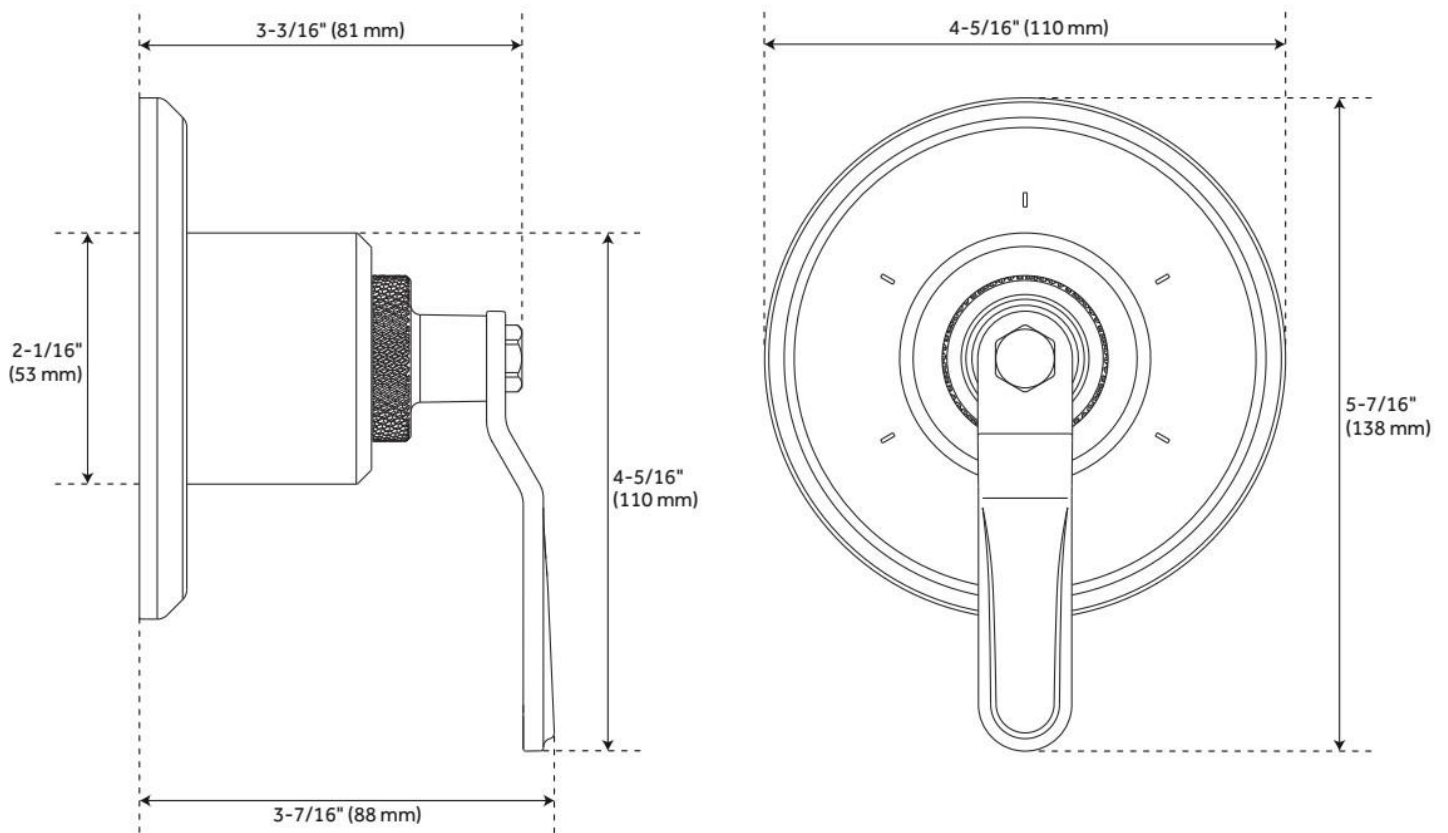

REVISED 5/30/2024

3-WAY IN-WALL DIVERTER ROUGH-IN VALVE - 3/4"

SKU: 446519
Code: SH6103

FEATURES

Material: Brass
Cartridge Type: Ceramic Disc



IAPMO, ASME A112.18.1/CSA B125.1, ASME A112.18.2/CSA B125.2, Massachusetts Accepted, LISTED ID: SH6103



ADDITIONAL FEATURES

- Six total settings allow for shared water flow between outlets, giving you the ability to use two functions at once.
- Ceramic cartridge.
- Available Single-Function Diverter Valve Cartridge restricts water flow to one outlet at a time.
- Not intended as a shut off valve.
- For installations only requiring 2 outlets, the 3rd outlet may be looped into one of the existing pipes.
- Compatible with Beasley, Berwyn, Boca Raton, Drea, Edenton, Elita, Greyfield, Gunther, Hibiscus, Key West, Lentz, Lexia, Pendleton, Pinecrest, Provincetown, Rigi, Sefina, Vassor and Vilamonte Diverter Trims.

REVISED 5/24/2024

3-WAY IN-WALL DIVERTER ROUGH-IN VALVE - 3/4"

SKU: 446519
Code: SH6103

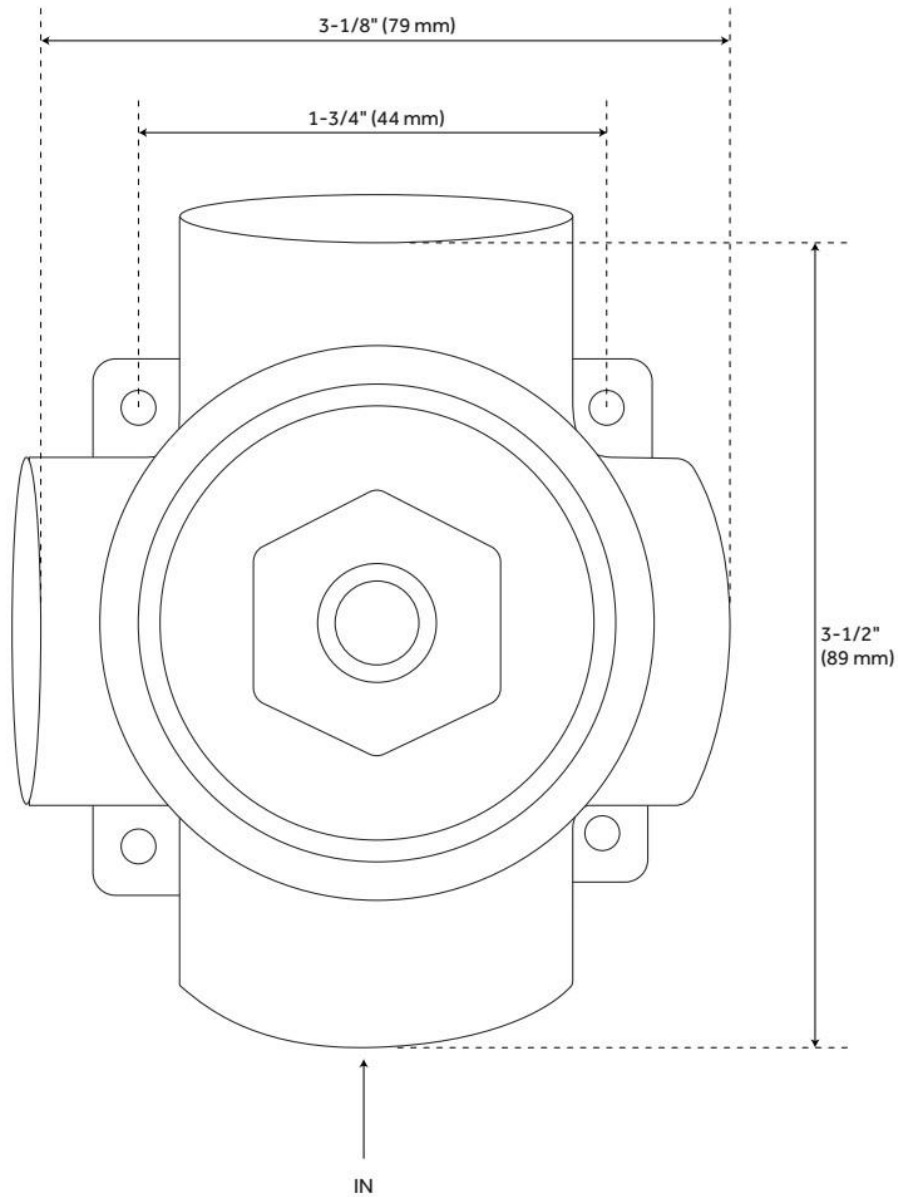

REVISED 5/24/2024