

COUPLINGS, FITTINGS, VALVES AND ACCESSORIES

FIRE PROTECTION PRICE LIST

PL2021-FP
Effective April 2, 2021



ENGINEERING CONFIDENCE INTO EVERY BUILD



Around the world and across diverse business lines, Victaulic provides durable pipe joining solutions that solve the construction industry's toughest challenges.

Since 1919, Victaulic's innovative piping products and design services continue to **increase construction productivity** and **reduce risk, ensuring projects are completed safely, on time and within budget.**

With more than 40 international facilities, Victaulic helps customers in 140 countries succeed in the global construction industry.

FIRE PROTECTION | HVAC | PLUMBING | OIL & GAS | MINING | WATER & WASTEWATER | POWER GENERATION | MARITIME



victaulic.com

© 2021 VICTAULIC COMPANY. ALL RIGHTS RESERVED.
Source: skyscrapercenter.com and the Council on Tall Buildings and Urban Habitat



Index

SECTION 1 – FireLock™ and Fire Protection Products	
Style 109 FireLock™ Installation-Ready™ One-Bolt Coupling	
Style 009N FireLock EZ™ Rigid Coupling	
Style 005H FireLock™ Rigid Coupling	
FireLock™ Innovative Groove System (IGS)	
FireLock™ Installation-Ready™ Fittings	
FireLock™ and Standard Fittings	
Style 744 FireLock™ Flange Adapter	
No. 65 End of Run Fitting IGS™ Grooved Outlet	
No. 67 End of Run Fitting	
No. 10-DR Drain Elbow	
Series 728 FireLock™ Grooved End Ball Valve	
Series 705 FireLock™ Butterfly Valve – Supervised OPEN	
Series 707C FireLock™ Butterfly Valve – Supervised CLOSED	
Series 765 FireLock™ High Pressure Butterfly Valve – Supervised OPEN	
Series 766 FireLock™ High Pressure Butterfly Valve – Supervised CLOSED	
Series 771 OS&Y and Series 772 NRS Gate Valves	
Series 773 and Series 774 Post Indicators	
Supervisory Switches	
Series 717H and 717 FireLock™ Check Valves	
Series 722 FireLock™ Threaded Ball Valve	
Series 732H FireLock™ Wye-Type Vic-Strainer	
Style 720 Alarm Test Module	
Style 735 FireLock™ Fire Pump Test Meter	
SECTION 2 – Victaulic® Hydraulic Control Valves	
Series 867-42T Pressure Reducing Valve	
Series 867-7UL Pressure Reducing Valve	
Series 867-43T Pressure Relief Valve	
Series 867-4UF Pressure Relief Valve	
Series 867-7UF Pressure Relief Valve	
Series 866-460 Level Control BERMAD Valve	
Series 866-465 Level Control BERMAD Valve	
Series 866-466 Level Control BERMAD Valve	
Series 866-482 Level Control BERMAD Valve	
Series 867-3HC Direct Acting Pressure Relief Valve/Fire Pump Casting Relief	

SECTION 3 – Hole Cut Products	
Style 920/920N <i>Mechanical-T</i> Outlet	
<i>Vic-Tap</i> II Hot Tap	
Style 920/920N <i>Mechanical-T</i> Cross	
Style 922 Outlet Tee	
Style 923 Strapless Outlet	
SECTION 4 – Couplings, Spare Parts and Fittings	
Style 07 Zero-Flex™ Rigid Coupling	
Style 177N QuickVic™ Flexible Coupling	
Style 77 Standard Coupling	
Style 75 Flexible Coupling	
Style 750 Reducing Coupling	
Spare Parts	
IPS Size Grooved End Fittings	
SECTION 5 – VicFlex™ Flexible Stainless Steel Sprinkler Fittings	
Series AH2-CC Hose	
Series AH2-CC-300 Hose	
Series AH2 Hose	
Series AH2-300 Hose	
Series AH1-CC Hose	
Series AH1 Hose	
Series AH5 Hose	
VicFlex™ Preassembled System Order Form	
VicFlex™ Brackets	
VicFlex™ Reducers and End Fittings	
VicFlex™ Style AB6 Assembly – Cold Storage	
VicFlex™ Style AB6 Bracket Assembly Order Form	
Model VS1 VicFlex™ Dry Sprinkler	
Series AQC Assembly For Clean Room Applications	
Series AQD Assembly For Duct Systems	
SECTION 6 – Vic-Press™ System for Schedule 10S Stainless Steel Pipe	
Vic-Press™ – Press System for Schedule 10S, Type 304 Stainless Steel Piping	
Vic-Press™ – Press System for Schedule 10S, Type 316 Stainless Steel Piping	
SECTION 7 – Pipe Preparation Tools	
VE12 Groove-In-Place	
VE26 S/C Groove-In-Place	
VE26/VE46 Power Drive Kit	
VE46 Groove-In-Place	
VE226 B/S/M/C Portable Grooving Tool	
VE226 Power Drive Kit	

Index

RG2100 Roll Grooving Tool	
VE106 Groove-N-Go	
VE206 Portable Roll Grooving Tool	
VE272SFS Field Roll Grooving Tool	
VE268 Shop Fabrication Grooving Tool	
VAPS 112 Pipe Stand	
VHCT 900 Hole Cutting Tool	
HCT908 Hole Cutting Tool	
PFT510 Vic-Press™ Tool for Schedule 10S Stainless Steel Pipe	

NOTE: Categories can have a single discount applied. Any individual discounts listed will take precedence over category discounts.

Submitted By: _____	Date: _____
Approved By: _____	Date: _____

Table of Contents

SECTION 1 – FireLock™ and Fire Protection Products

Style 109 FireLock™ Installation-Ready™ One Bolt Rigid Coupling	1-2
Style 009N FireLock EZ™ Rigid Coupling	1-2
Style 005H FireLock™ Rigid Coupling	1-3
FireLock™ Innovative Groove System (IGS)	
No. 142 Welded Outlet	1-4
Style 922 and Style 920N Outlet-T	1-4
No. 101 Installation-Ready™ 90° Elbow	1-5
Style 108 Installation-Ready™ Rigid Coupling	1-5
Style 115 Installation-Ready™ Reducing Coupling	1-5
No. 102 Installation-Ready™ Tee	1-6
No. 148 Sprinkler Reducer	1-6
No. 143 IGS™ Nipple	1-7
No. 111 Grooved End Elbow	1-7
No. 145 Female Threaded x Groove 90° Elbow	1-7
No. 147 Back-to-Back Sprinkler Tee	1-8
No. 65 End of Run Fitting IGS™ Grooved Outlet	1-8
No. 146 Cap	1-8
No. 140 Male Threaded x Groove Adapter	1-9
No. 141 Female Threaded x Groove Adapter	1-9
No. 116 CPVC Adapter	1-9
No. 144 OGS x IGS™ Grooved Concentric Reducer	1-10
WB-1 and NAP-1 Weld Plunger Cone	1-10
FireLock™ Installation-Ready™ Fittings	
No. 101 90° Elbow	1-12
No. 103 45° Elbow	1-12
No. 102 Tee	1-13
No. 104 Installation-Ready™ Bull Head Tee	1-13
No. 143 Close Nipple	1-13
FireLock™ and Grooved IPS Pipe Fittings	
No. 001 – 90° FireLock™ Elbow	1-14
No. 003 – 45° FireLock™ Elbow	1-14
No. 10 - 90° IPS Elbow	1-14
No. 11 - 45° IPS Elbow	1-14
No. 002 – FireLock™ Tee	1-15
No. 006 – FireLock™ Cap	1-15
No. 20 IPS Tee	1-15
No. 60 IPS Cap	1-16
Style 744 FireLock™ Flange Adapter	1-16
Flange Adapter Notes	1-17
No. 65 End of Run Fitting IGS™ Grooved Outlet	1-17
No. 67 End of Run Fitting	1-18
No. 10-DR Drain Elbow	1-18
Series 728 FireLock™ Ball Valve	1-19
Series 705 Butterfly Valve – Supervised OPEN	1-20
Series 705 Weatherproof Actuator Replacement Kit	1-20
Series 707C Butterfly Valve – Supervised CLOSED	1-21
Series 765 High Pressure Butterfly Valve – Supervised OPEN	1-21
Series 766 High Pressure Butterfly Valve – Supervised CLOSED	1-22
Series 771 OS&Y and Series 772 NRS Gate Valves	1-23

Flange Mounting Kits – Series 772H NRS	1-23
Series 773 and Series 774 Post Indicators	1-24
Supervisory Switches	1-24
Series 717H FireLock™ Check Valve	1-24
Series 717 FireLock™ Check Valve	1-25
Series 722 Threaded Ball Valve	1-25
Series 732H FireLock™ Wye-Type <i>Vic-Strainer</i>	1-26
Series 720 Alarm Test Module	1-26
Series 720 Alarm Test Module with Gauge Port Tap	1-26
Series 720 Alarm Test Module with Pressure Relief Option	1-27
Series 720 Alarm Test Module With Pressure Relief and Gauge Port Options	1-27
Pressure Relief Valve Kit for Series 720	1-27
Series 735 Fire Pump Test Meter	1-28
SECTION 2 – Victaulic® Hydraulic Control Valves	
Series 867-42T Pressure Reducing Valve	2-2
Series 867-7UL Pressure Reducing Valve	2-2
Series 867-43T Pressure Relief Valve and Series 874-43T-PS Suction Control Valve	2-3
Series 867-4UF Pressure Relief Valve	2-3
Series 867-7UF Pressure Relief Valve	2-4
Series 867-3HC Direct Acting Pressure Relief Valve/ Fire Pump Casing Relief Valve	2-4
Series 866-460 Level Control BERMAD Valve with Modulating Horizontal Float	2-5
Series 866-465 Level Control BERMAD Valve with Bi-Level Electric Float	2-5
Series 866-466 Level Control BERMAD Valve with Vertical Float	2-6
Series 866-482 Level Control BERMAD Valve with Altitude Pilot	2-6
SECTION 3 – Hole Cut Products	
Styles 920/920N <i>Mechanical-T</i> Outlet	3-2
<i>Vic-Tap II</i>	3-4
Styles 920/920N <i>Mechanical-T</i> Cross	3-5
Style 922 Outlet Tee	3-8
Style 923 Strapless Outlet	3-9
SECTION 4 – Couplings, Spare Parts and Fittings	
Style 07 Zero-Flex™ Rigid Coupling	4-2
Style 177N QuickVic Flexible Coupling for Steel	4-2
Style 77 Standard Flexible Coupling	4-3
Style 75 Flexible Coupling	4-3
Style 750 Reducing Coupling	4-4
Lubricant	4-5
Gaskets	4-5
Metal Liners	4-6
Plated Trackhead Bolts and Nuts	4-7
Go-No-Go Pipe Tape	4-7
GDC-FP Go-No-Go Pipe Tape	4-7
Elbows –	
No. 12 - 22½°	4-8
No. 13 - 11¼°	4-8
No. 100 and No. 110 1½ D Long Radius Elbows	4-8
No. 29M Tee with Threaded Branch	4-9

Table of Contents

No. 35 Cross	4-9	Style P500 Loose Seals	6-11
No. 33 True Y	4-9	Style P507 Standard Coupling	6-11
No(s). 40, 42, and 43 Adapter Nipples	4-10	Style P576 Male Adapter – Threaded	6-11
No. 80 Female Threaded Adapter	4-10	Style P508 Slip Coupling	6-12
No(s). 18 and 19 Adapter Elbows	4-11	Series P569 Stainless Steel Ball Valve	6-12
No. 25 Grooved Reducing Tee	4-12	Series P569 Repair Kits	6-12
No. 29T Threaded Reducing Tee	4-14	Series P589 Brass Body Ball Valve	6-13
No. 50 Concentric Reducer	4-16	Style P568 90° Elbow – Short Tangent	6-13
No. 51 Eccentric Reducer	4-16	Style P562 90° Street Elbow	6-13
No. 52 Reducer – Male Threaded Small End	4-18	Style P571 45° Elbow	6-14
SECTION 5 – VicFlex™ Flexible Sprinkler Fitting Systems		Style P563 45° Street Elbow	6-14
Series AH2-CC	5-2	Style P572 Tee	6-14
Series AH2-CC-300 VicFlex™ Hose	5-2	Style P573 Tee – Reducing Branch	6-15
Series AH2 VicFlex™ Hose	5-3	Style P578 Tee – Reducing Branch Threaded	6-15
Series AH2-300 VicFlex™ Hose	5-3	Style P574 Concentric Reducer	6-16
Series AH1-CC	5-3	Style P575 Flange Adapter	6-16
Series AH1 VicFlex™ Hose	5-4	Style P566 Flange Adapter	6-16
VicFlex™ Brackets	5-5	Style P577 Adapter Nipple	6-17
VicFlex™ Reducers and End Fittings	5-6	Style P585 Threaded Union	6-17
VicFlex™ Preassembled System Order Form	5-6	Style P579 Female Adapter – Threaded	6-17
VicFlex™ Style AB6 Assembly – Cold Storage	5-8	Style P560 End Cap	6-18
VicFlex™ Style AB6 Bracket Assembly Order Form	5-8	PFT510 Vic-Press Tool	6-18
VicFlex™ Dry Sprinkler Model VS1	5-10	Section 7 – Pipe Preparation Tools	
Model VS1 Cover Plates	5-10	IGS™ Roll Grooving Tools – Field Portable	
Clean Room Cover Seal Gasket	5-10	RG1	7-2
VicFlex™ Dry Sprinkler Brackets	5-11	Roll Grooving Tools – Field Portable	
VicFlex™ Dry Sprinkler Model VS1 Order Form	5-11	VE12	7-2
Series AQC-U Assembly for Clean Room Applications	5-13	VE26 S/C	7-2
SECTION 6 – Vic-Press™ System		VE26/VE46 Power Drive Kit	7-2
for Schedule 10S Stainless Steel Pipe		VE46	7-3
Style P500 Loose Seals	6-3	VE226 B/S/M/C/BSS/MSS/P	7-3
Style P597 Standard Coupling	6-3	VE226 Power Drive Kit	7-3
Style P596 Male Adapter – Threaded	6-3	RG2100 Roll Grooving Tool	7-4
Series P569 Type 316 Stainless Steel Ball Valve	6-4	Roll Grooving Tools – Field Fabrication	
Series P589 Brass Body Ball Valve	6-4	VE106	7-5
Style P586 90° Elbow – Short Tangent	6-4	VE206	7-6
Style P542 90° Street Elbow	6-5	VE272SFS	7-7
Style P591 45° Elbow	6-5	Roll Grooving Tools – Shop Fabrication	
Style P543 45° Street Elbow	6-5	VE268	7-8
Style P592 Tee	6-6	VAPS112 Pipe Stand	7-9
Style P593 Tee – Reducing Branch	6-6	Hole Cutting Tools	
Style P588 Tee – Reducing Branch – Threaded	6-6	VHCT900	7-10
Style P594 Concentric Reducer	6-7	HCT908	7-10
Style P595 Flange Adapter	6-7	Vic-Press™ Tool	
Style P565 Flange Adapter	6-7	PFT510	7-11
Style P587 Transition Nipple	6-8	How to Order	7-12
Style P584 Threaded Union	6-8	Terms and Conditions of Tool Rental	7-13
Style P599 Female Adapter – Threaded	6-8	Terms and Conditions of Tool Sale	7-13
Style P561 Adapter	6-9	Terms and Conditions of Sale	Inside Back Cover
Style P540 End Cap	6-9	Warranty	Inside Back Cover
PFT510 Vic-Press Tool	6-9		

Gaskets

Gasket Selection Guide



IMPORTANT PLEASE READ BEFORE ORDERING.
Gasket selection must always be specified on your order.

For information pertaining to gasket seals for couplings, seals for Vic-Press™ products, O-rings for Victaulic® Bolted Split Sleeve products and general definition/seal material Selection, refer to publication 05.01.

For specific chemical and temperature compatibility, refer to the Gasket Chemical Services Guide Long Report (GSG-100).



FireLock™ and Fire Protection Products



FireLock™ System for Grooved IPS Pipe

FireLock™
Installation-Ready™
One Bolt Rigid
Coupling

STYLE 109

Refer to publication 10.64



STYLE 109 – GRADE “E” (TYPE A) GASKET

PIPE inches		Approx. Wgt. Ea.	COUPLING COMPLETE † with Grade “E” (Type A) Gasket		SPARE PARTS Grade “E” (Type A) Gasket
Nom. Size	Outside Dia.		Price Each		
		lb	Painted		
1¼	1.660	1.4	\$75.50		\$70.50
1½	1.900	1.5	76.50		76.00
2	2.375	1.8	86.50		79.50
2½	2.875	2.1	99.50		88.00
3	3.500	2.6	112.50		101.00
4	4.500	3.4	157.50		131.50

NOTE: Items listed in shaded areas are non-cancellable and non-returnable.

† Surcharge for couplings supplied without gasket. Contact Victaulic for pricing.

FireLock EZ™
Rigid Coupling

STYLE 009N

Refer to publication 10.64



STYLE 009N – GRADE “E” (TYPE A) GASKET

PIPE inches		Approx. Wgt. Ea.	COUPLING COMPLETE † with Grade “E” (Type A) Gasket		COUPLING COMPLETE † with Grade “E” (Type A) Gasket and Stainless Steel Bolts & Nuts	SPARE PARTS Grade “E” (Type A) Gasket
Nom. Size	Outside Dia.		Price Each		Price Each	
		lb	Painted	Galv.	Galv.	
1¼	1.660	1.4	\$77.50	\$93.00	\$184.50	\$73.50
1½	1.900	1.5	78.50	94.00	187.50	78.00
2	2.375	1.9	89.00	103.50	206.50	82.50
2½	2.875	2.1	102.00	120.50	243.00	90.50
3	3.500	2.3	115.50	142.50	286.00	103.00
4	4.500	2.9	161.00	192.50	388.50	135.00
5	5.563	5.0	213.00	267.00	537.50	136.00
6	6.625	5.9	253.00	307.00	619.50	144.00
8	8.625	11.4	422.00	512.00	1032.50	206.50
10	10.750	22.6	2687.50	3871.50	7820.50	1321.00
12	12.750	27.6	3348.50	4668.00	9428.00	1367.50

NOTE: Items listed in shaded areas are non-cancellable and non-returnable.

† Surcharge for couplings supplied without gasket. Contact Victaulic for pricing.

FireLock™ System for Grooved IPS Pipe

FireLock™ Rigid Coupling

STYLE 005H

Refer to publication 10.02



STYLE 005H – GRADE “E” (TYPE A) GASKET

PIPE inches		COUPLING COMPLETE † With Grade “E” (Type A) Gasket			SPARE PARTS			
Nom. Size	Outside Dia.	Approx. Wgt. Each lb	Price Each		Grade E (Type A) Gasket Only Price Ea.	Bolt & Nut *		
			Painted	Galv.		No.	Size inches	Price Each Pltd.
1¼	1.660	1.2	\$86.50	\$104.00	\$77.00	2	¾ x 2¼	\$24.00
1½	1.900	1.2	89.50	105.50	81.50	2	¾ x 2¼	24.00
2	2.375	1.6	98.00	117.00	87.00	2	¾ x 2½	25.00
2½	2.875	1.9	114.50	135.00	95.00	2	¾ x 2½	25.00
3	3.500	2.1	128.50	157.50	108.00	2	¾ x 2½	25.00
4	4.500	3.1	180.50	216.00	144.00	2	¾ x 2½	25.00
5	5.563	4.5	218.00	275.00	142.00	2	½ x 3	32.50
6	6.625	5.0	261.50	317.00	155.00	2	½ x 3	32.50
8	8.625	11.3	437.00	528.50	221.50	2	5⁄8 x 4¼	36.00

NOTE: Items listed in shaded areas are non-cancellable and non-returnable.

* Number of bolts equals number of segments supplied.

Note: Style 005 FireLock bolts and nuts are sized for use with Style 005 couplings only and must not be used with other Victaulic products.

† Surcharge for couplings supplied without gasket. Contact Victaulic for pricing.

Grade E (Type A) EPDM gaskets are applicable for wet and dry fire sprinkler systems (ambient temperature) only.

FireLock™ Rigid Coupling

STYLE 005H

Refer to publication 10.02



STYLE 005H – GRADE “E” (TYPE A) FLUSH-SEAL™ GASKET

PIPE inches	Approx. Wgt. Each lb	COUPLING COMPLETE † With Grade “E” (Type A) Flush-Seal Gasket		SPARE PARTS Grade “E” (Type A) Flush-Seal Gasket Only Price Each
		Price Each		
Nom. Size		Painted	Galvanized	
1¼	1.2	\$116.00	\$127.00	\$104.00
1½	1.2	119.00	139.00	114.50
2	1.6	128.00	151.00	123.50
2½	1.9	154.00	176.50	128.00
3	2.1	164.00	191.00	151.50
4	3.1	228.00	266.50	200.50
5	4.5	375.00	430.50	279.00
6	5.0	413.00	482.00	356.00
8	11.3	666.50	772.00	390.50

NOTE: Items listed in shaded areas are non-cancellable and non-returnable.

Standard gasket and Flush-Seal™ gasket approved for dry pipe systems to –40°F/–40°C. Based on “typical” pipe surface conditions, supplemental lubricant is recommended for services installed below 0°F/–18°C and for all dry pipe systems or systems to be subjected to air tests prior to being filled with water. Supplemental lubrication may also be required on pipe with raised or undercut weld seams or pipe that has voids and/or cracks at the weld seams. Victaulic continues to recommend the use of Flush-Seal™ gaskets for dry services.

† Surcharge for couplings supplied without gasket. Contact Victaulic for pricing.

FireLock™ System for IGS Grooved IPS Pipe

FireLock™ IGS™ Groove System

Welded Outlet

NO. 142

Refer to publication 10.54



NO. 142 WELDED OUTLET

Nom. Size inches	Approx. Wgt. Ea.	Price Each *	Sold in Box Quantities of
Run x Branch	lb		
1¼ – 1½ x 1	0.2	\$5.00	100
1½ – 2	0.2	5.00	100
2 – 2½	0.2	5.00	100
2½ – 3	0.2	5.00	100
3 – 4	0.2	5.00	100

* Sold in box quantities only

Outlet-T and Mechanical-T Outlet

STYLE 922 AND STYLE 920N

Refer to publication 10.54



STYLE 922 OUTLET-T AND STYLE 920N MECHANICAL-T – GRADE “E” (TYPE A) GASKET

Nom. Size inches	Run x Branch	Style Number	Approx. Wgt. Ea. lb	COMPLETE with Grade “E” (Type A) Gasket Price Each	
				Painted	Galv.
1¼ x 1	922	1.1	\$17.50	\$23.00	
1½	922	1.2	17.50	23.00	
2	922	1.2	18.50	24.00	
2½	922	1.6	20.00	26.50	
3	920N	2.8	58.50	72.50	
4	920N	3.1	72.50	87.00	

FireLock™ System for IGS Grooved IPS Pipe

Installation-Ready™ 90° Elbow

NO. 101

Refer to publication 10.54



NO. 101 INSTALLATION-READY™ 90° ELBOW

Size		Approx. Wgt. Ea.	Price Each	
Nominal inches	Actual Outside Diameter inches		Painted	Galv.
1	1.315	2.2	\$19.00	\$24.50

Installation-Ready™ Rigid Coupling

STYLE 108

Refer to publication 10.54



STYLE 108 INSTALLATION-READY™ RIGID COUPLING

Size		Approx. Wgt. Ea.	Price Each	
Nominal inches	Actual Outside Diameter inches		Painted	Galv.
1	1.315	1.5	\$14.00	\$16.50

Installation-Ready™ Reducing Coupling

STYLE 115

Refer to publication 10.54



STYLE 115 INSTALLATION-READY™ REDUCING COUPLING

Size		Approx. Wgt. Ea.	Price Each	
Nominal inches			Painted	Galv.
1¼	x 1	1.9	\$20.00	\$24.50
1½		2.1	22.50	27.50

FireLock™ System for IGS Grooved IPS Pipe

Installation-Ready™ Tee

NO. 102

Refer to publication 10.54



NO. 102 INSTALLATION-READY™ TEE

Size		Approx. Wgt. Ea.	Price Each	
Nominal inches	Actual Outside Diameter inches		Painted	Galv.
1	1.315	3.0	\$23.00	\$29.50

Sprinkler Reducer

NO. 148

NPT or BSPT Sprinkler Outlet
Refer to publication 10.54



NO. 148 SPRINKLER REDUCER

End to End	Nominal Size	Threaded Outlet Size		Approx. Wgt. Each	Price Each *		Sold in Box Quantities of
		inches	inches		Painted	Galv.	
3.0	1	1/2	3/4	0.4	\$6.00	\$6.50	50
3.5	1	1/2	3/4	0.5	6.50	+	50
4.0	1	1/2	3/4	0.6	7.00	+	50
4.5	1	1/2	3/4	0.6	7.00	+	50
5.0	1	1/2	3/4	0.7	7.50	+	50
5.5	1	1/2	3/4	0.8	8.00	+	40
6.0	1	1/2	3/4	0.8	8.50	10.00	40
12.0	1	1/2	3/4	1.7	13.50	14.00	20
18.0	1	1/2	3/4	2.5	16.50	+	10
24.0	1	1/2	3/4	3.4	20.00	+	10
30.0	1	1/2	3/4	4.2	20.00	+	8
36.0	1	1/2	3/4	5.0	23.00	+	8

Note: 36" / 914.0 mm size features sprinkler outlet on both ends

* Sold in box quantities only

NOTE: Items listed in shaded areas are non-cancellable and non-returnable.

+ Quoted on application. Contact Victaulic for pricing and availability.

FireLock™ System for IGS Grooved IPS Pipe

IGS™ Nipple

NO. 143

Refer to publication 10.54



NO. 143 IGS™ NIPPLE

Size		End to End	Approx. Wgt. Each	Price Each *	Sold in Box Quantities of
Nominal inches	Actual Outside Diameter inches	inches	lb		
1	1.315	1.5	0.2	\$2.50	25
1	1.315	2.0	0.3	3.00	25
1	1.315	2.5	0.4	4.00	25
1	1.315	3.0	0.4	4.50	25
1	1.315	3.5	0.5	5.00	25
1	1.315	4.0	0.6	5.50	25
1	1.315	4.5	0.6	6.00	25
1	1.315	5.0	0.7	7.00	25

* Sold in box quantities only

Grooved End Elbow

NO. 111

Refer to publication 10.54



NO. 111 GROOVED END ELBOW

Size	Approx. Wgt. Ea.	Price Each	
Nominal inches	lb	Painted	Galv.
1	0.64	\$7.50	\$9.50

NOTE: Items listed in shaded areas are non-cancellable and non-returnable.

Female Threaded x Groove 90° Elbow

NO. 145

Refer to publication 10.54



NO. 145 FEMALE THREADED X GROOVE 90° ELBOW

Size	Approx. Wgt. Ea.	Price Each	
Nominal inches	lb	Painted	Galv.
Threaded x Grooved 1/2" x 1"	0.5	\$8.50	\$10.00
	0.5	8.50	10.00
	0.5	8.50	10.00

FireLock™ System for IGS Grooved IPS Pipe

Back-to-Back Sprinkler Tee

NO. 147

Refer to publication 10.54



NO. 147 BACK-TO-BACK SPRINKLER TEE

Size		Approx. Wgt. Ea.	Price Each	
Nominal inches		lb	Painted	
½	x ½	0.7	\$16.00	

End of Run Fitting IGS™ Grooved Outlet

NO. 65

Refer to publication 10.54



END OF RUN FITTING

Nominal Size inches	Approx. Weight Each lb	Price Each	
		Painted	Galv.
1¼ x 1	0.7	\$24.00	\$29.00
1½	0.8	24.00	29.00
2	1.2	25.50	33.50
2½	1.6	29.50	36.50
3	2.6	39.00	48.00

Cap

NO. 146

Refer to publication 10.54



NO. 146 CAP

Size		Approx. Wgt. Ea.	Price Each		Sold in Box Quantities of
Nominal inches	Actual Outside Diameter inches	lb	Painted	Galv.	
1	1.315	0.2	\$5.50	\$7.00	20

* Sold in box quantities only

FireLock™ System for IGS Grooved IPS Pipe

Male Threaded x Groove Adapter

NO. 140
Refer to publication 10.54



NO. 140 MALE THREADED X GROOVE ADAPTER

Size		Approx. Wgt. Ea.	Price Each *	Sold in Box Quantities of
Nominal inches	Actual Outside Diameter inches	lb		
1	1.315	0.3	\$5.00	50

* Sold in box quantities only

Female Threaded x Groove Adapter

NO. 141
Refer to publication 10.54



NO. 141 FEMALE THREADED X GROOVE ADAPTER

Size		Approx. Wgt. Ea.	Price Each *	Sold in Box Quantities of
Nominal inches	Actual Outside Diameter inches	lb		
1	1.315	0.5	\$5.00	50

* Sold in box quantities only

CPVC Adapter

NO. 116
1" SOCKET X 1" IGS™ GROOVE
Refer to publication 10.54



NO. 116 CPVC ADAPTER

Size		Approx. Wgt. Ea.	Price Each *	Sold in Box Quantities of
Nominal inches	Actual Outside Diameter inches	lb		
1	1.315	0.19	\$20.50	10

* Sold in box quantities only

NOTE: Items listed in shaded areas are non-cancellable and non-returnable.

FireLock™ System for IGS Grooved IPS Pipe

OGS x IGS™ Grooved Concentric Reducer

NO. 144

Refer to publication 10.54



NO. 144 OGS X IGS™ GROOVED CONCENTRIC REDUCER

Nominal Size inches	Approx. Wgt. Ea. lb	Price Each *		Sold in Box Quantities of
		Painted	Galv.	
1 x 1¼	0.5	\$8.00	\$10.00	25
	0.6	10.00	13.50	25

* Sold in box quantities only

Weld Plunger Cone

Refer to publication 10.54



WB-1



NAP-1

WELD PLUNGER CONE

Model	Approx. Weight Each lbs	Victaulic Part Code	Price Each
WB-1	2.2	A010AQBWLB	\$565.00 ^{NR}
NAP-1	0.3	A010AQBNAF	565.00 ^{NR}

^{NR} Non-returnable

FireLock™ System for IGS Grooved IPS Pipe

Roll Grooving Tool

Refer to Section 7 – Pipe Preparation Tools for prices and where to call for purchase information.

RG2100 FOR 1" FIRELOCK™ IGS™



Roll Grooving Tool

Refer to Section 7 – Pipe Preparation Tools for prices and where to call for purchase information.

RG1 FIELD PORTABLE ROLL GROOVING TOOL

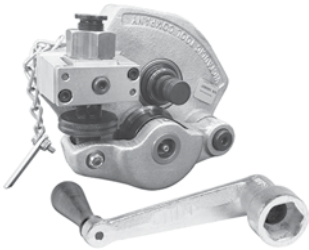

GDC-FP

Refer to Section 4 – Couplings, Spare Parts and Fittings for prices and where to call for purchase information.

GO/NO-GO POCKET-SIZED IGS GROOVE DIAMETER CABLES FOR 1" CARBON STEEL PIPE



FireLock™ System for Grooved IPS Pipe

FireLock™ Installation-Ready™ Fittings

90° Elbow

NO. 101

Refer to publication 10.06



NO. 101 90° ELBOW – GRADE “E” (TYPE A) GASKET

PIPE inches		Approx. Wgt. Ea.	COUPLING COMPLETE † with Grade “E” (Type A) Gasket		SPARE PARTS Grade “E” (Type A) Gasket
Nom. Size	Outside Dia.		Price Each		
		Painted	Galv.		
1¼	1.660	3.2	\$184.50	\$230.50	\$133.50
1½	1.900	3.7	190.00	236.50	141.00
2	2.375	5.4	191.00	238.00	150.00
2½	2.875	6.4	230.50	287.00	164.50

† Surcharge for fittings supplied without gasket. Contact Victaulic for pricing.

NOTE: Items listed in shaded areas are non-cancellable and non-returnable.

45° Elbow

NO. 103

Refer to publication 10.06



NO. 103 45° ELBOW – GRADE “E” (TYPE A) GASKET

PIPE inches		Approx. Wgt. Ea.	COUPLING COMPLETE † with Grade “E” (Type A) Gasket		SPARE PARTS Grade “E” (Type A) Gasket
Nom. Size	Outside Dia.		Price Each		
		Painted	Galv.		
1¼	1.660	2.8	\$184.50	\$230.50	\$133.50
1½	1.900	3.1	190.00	236.50	141.00
2	2.375	4.4	191.00	238.00	150.00
2½	2.875	4.9	230.50	287.00	164.50

† Surcharge for fittings supplied without gasket. Contact Victaulic for pricing.

NOTE: Items listed in shaded areas are non-cancellable and non-returnable.

FireLock™ System for Grooved IPS Pipe

Tee

NO. 102

Refer to publication 10.06



NO. 102 TEE – GRADE “E” (TYPE A) GASKET

PIPE inches		Approx. Wgt. Ea. lb	COUPLING COMPLETE † with Grade “E” (Type A) Gasket		SPARE PARTS
Nom. Size	Outside Dia.		Price Each		Grade “E” (Type A) Gasket
		Painted	Galv.		
1¼	1.660	4.2	\$283.50	\$354.00	\$198.50
1½	1.900	4.6	293.00	366.00	211.00
2	2.375	6.4	297.00	371.00	224.00
2½	2.875	7.5	342.50	428.50	245.50

† Surcharge for fittings supplied without gasket. Contact Victaulic for pricing.

NOTE: Items listed in shaded areas are non-cancellable and non-returnable.

Installation-Ready™ Bull Head Tee

NO. 104

Refer to publication 10.06



NO. 104 INSTALLATION-READY™ BULL HEAD TEE

PIPE inches				Approx. Weight Each lb	COUPLING COMPLETE † with Grade “E” (Type A) Gasket		SPARE PARTS	
Nom. Size					Price Each		Grade “E” (Type A) Gasket	
				Painted	Galv.			
1½	x	1½	x	2	7.0	\$314.50	\$393.00	\$200.00
2	x	2	x	2½	8.6	321.00	400.50	212.00
2½	x	2½	x	3	10.8	369.00	461.00	232.50

† Surcharge for fittings supplied without gasket. Contact Victaulic for pricing.

NOTE: Items listed in shaded areas are non-cancellable and non-returnable.

Close Nipple

NO. 143

Refer to publication 10.06



NO. 143 CLOSE NIPPLE

Size		End to End inches	Approx. Wgt. Ea. lb	Price Each
Nominal	Actual Outside Diameter			
inches				
1¼	1.660	2.375	0.4	\$46.00
1½	1.900	2.375	0.5	50.00
2	2.375	2.375	0.7	59.50
2½	2.875	2.375	1.1	71.50

NOTE: Items listed in shaded areas are non-cancellable and non-returnable.

FireLock™ System for Grooved IPS Pipe

FireLock™ Fittings

FireLock™ Fittings

90° ELBOW NO. 001
45° ELBOW NO. 003
Refer to publication 10.03



No. 001



No. 003



FIRELOCK™ FITTINGS – 90° ELBOW OR 45° ELBOW

Nom. Size	90° Elbow No. 001			45° Elbow No. 003		
	Approx. Wgt. Each lb	Price Each		Approx. Wgt. Each lb	Price Each	
		Painted	Galv.		Painted	Galv.
inches						
2	1.7	\$67.50	\$86.50	1.8	\$67.50	\$86.50
2½	3.1	90.50	120.50	2.2	90.50	112.00
3	4.0	117.50	155.50	3.1	117.50	147.00
4	6.7	167.50	230.50	5.6	167.50	222.00
5	12.6	390.50	513.50	8.3	390.50	479.50
6	18.3	458.50	629.00	11.7	458.50	577.50
8	25.5	893.00	1269.50	20.4	893.00	1226.50

NOTE: FireLock™ Fittings are designed for use with FireLock™ and FireLock EZ™ couplings. Use of other products may result in bolt pad interference.

NOTE: Items listed in shaded areas are non-cancellable and non-returnable.

Fittings

90° ELBOW NO. 10
45° ELBOW NO. 11
Refer to publication 07.01

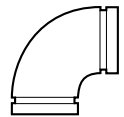

No. 10



No. 11



FITTINGS – 90° ELBOW OR 45° ELBOW

Nom. Size	90° Elbow No. 10				45° Elbow No. 11			
	Approx. Wgt. Ea. lb	C - E inches	Price Each		Approx. Wgt. Ea. lb	C - E inches	Price Each	
			Painted	Galv.			Painted	Galv.
inches								
¾	0.5	2.25	\$252.00	\$266.00	0.5	1.50	\$252.00	\$266.00
1	0.6	2.25	135.50	178.50	0.6	1.75	135.50	170.50
1¼	1.0	2.75	135.50	178.50	0.9	1.75	135.50	170.50
1½	1.2	2.75	135.50	178.50	0.9	1.75	135.50	170.50
10	63.3	9.00	2754.00	3442.50	37.5	4.75	1787.00	2233.50
12	74.0	10.00	3029.00	3787.00	66.7	5.25	2144.00	2681.50

NOTE: Items listed in shaded areas are non-cancellable and non-returnable.

(sw) Victaulic fittings are made of ductile iron, except those marked (sw) segmentally welded steel.

FireLock™ System for Grooved IPS Pipe

FireLock™ Fittings

TEE NO. 002
CAP NO. 006

Refer to publication 10.03



No. 002



No. 006



FIRELOCK™ FITTINGS – TEE OR CAP

Nom. Size	Approx. Wgt. Each lb	Tee No. 002		Approx. Wgt. Each lb	Cap No. 006	
		Price Each			Price Each	
		Painted	Galv.		Painted	Galv.
1¼	–	+	+	0.3	\$37.50	\$57.50
1½	–	+	+	0.4	39.50	57.50
2	2.4	\$103.00	\$127.50	0.6	47.00	63.50
2½	3.6	134.00	170.50	1.0	54.50	67.50
3	5.3	185.00	237.00	1.2	64.50	81.50
4	8.7	279.00	361.50	2.4	93.50	127.00
5	15.7	640.00	800.50	4.1	185.00	252.00
6	22.7	737.00	961.50	5.9	206.00	283.50
8	38.7	1564.50	2066.00	12.7	390.00	531.50

NOTE: FireLock™ Fittings are designed for use with FireLock™ and FireLock EZ™ couplings. Use of other products may result in bolt pad interference.

NOTE: Items listed in shaded areas are non-cancellable and non-returnable.

+ Quoted on application. Contact Victaulic for pricing and availability.

Fittings

TEE NO. 20

Refer to publication 07.01

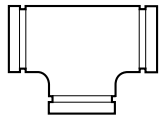

No. 20



FITTINGS – STANDARD TEE

Nom. Size	Approx. Wgt. Ea. lb	Tee No. 20	
		Price Each	
		Painted	Galv.
¾	0.6	\$270.00	\$291.50
1	1.0	208.50	271.00
1¼	1.5	208.50	271.00
1½	2.0	208.50	271.00
10	73.0	3294.00	4117.00
12	99.0	4282.50	5352.00

NOTE: Items listed in shaded areas are non-cancellable and non-returnable.

FireLock™ System for Grooved IPS Pipe

Fittings

CAP NO. 60

Refer to publication 07.01

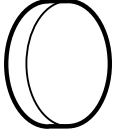

No. 60



FITTINGS – CAP

Nom. Size inches	Approx. Wgt. Ea. lb	Cap No. 60 Price Each		Tapped Cap No. 60 Price Each
		Painted	Galv.	Painted
¾	0.2	\$271.50	\$296.00	–
1	0.3	116.00	136.50	–
1¼	0.3	116.00	136.50	–
1½	0.5	116.00	136.50	–
2	0.6	116.00	136.50	\$583.00
2½	1.0	116.00	136.50	589.00
3	1.4	116.00	136.50	731.50
3½	2.5	123.50	161.50	–
4	2.5	123.50	161.50	749.00
5	4.6	284.50	381.00	–
6	6.0	284.00	381.00	825.00
8	13.1	540.50	714.50	984.50
10	21.0	943.50	1180.50	–
12	35.6	1650.00	2063.00	–

NOTE: Items listed in shaded areas are non-cancellable and non-returnable.

Caps are malleable/ductile iron.

FireLock™ Flange Adapter

STYLE 744 – 175 PSI WITH GRADE “E” (TYPE A) GASKET

Refer to publication 10.04



STYLE 744 – GRADE “E” (TYPE A) GASKET

PIPE inches		VIC-FLANGE COMPLETE †			SPARE PARTS
Nominal Size	Outside Diameter	Approx. Wgt. Each lb	Price Each		Grade “E” (Type A) Gasket Price Ea.
			Painted	Galv.	
Style 744 - Hinged					
2	2.375	2.7	\$328.50	\$380.50	\$63.50
2½	2.875	4.2	382.00	452.50	74.00
3	3.500	4.8	429.50	514.00	77.50
4	4.500	6.5	558.00	678.50	101.50 ^{NR}
5	5.563	8.3	668.50	815.00	119.00
6	6.625	9.0	729.50	886.50	139.00 ^{NR}
8	8.626	13.9	915.00	1143.50	184.50 ^{NR}

NOTE: Items listed in shaded areas are non-cancellable and non-returnable.

The *Vic-Flange* adapters utilize standard ANSI 125/150 flange bolts (supplied by installer). Bolt hole pattern is standard for ANSI CL. 150 and 125 CL flanges.

For Flange Washers see Spare Parts.

† Surcharge for couplings supplied without gasket. Contact Victaulic for pricing.

^{NR} Non-returnable

FireLock™ System for Grooved IPS Pipe

Victaulic Flange Adapter Washer Notes



Victaulic flange adapters require a smooth, hard surface at the mating flange face for effective sealing. Some applications, for which the Victaulic flange adapter is otherwise well suited, do not provide an adequate mating surface. In such cases, it is recommended that a metal flange washer be inserted between the Victaulic flange adapter and the mating flange to provide the necessary sealing surface. See Spare Parts Section for flange washer prices.

Typical applications where a Victaulic flange washer should be used are:

1. When mating to a serrated flange: a flange gasket should be used adjacent to the serrated flange. The flange washer is then inserted between the Victaulic flange adapter and the flange gasket.
2. When mating to a wafer valve: where typical valves are rubber lined and partially rubber faced (smooth or not), the flange washer is placed between the valve and the Victaulic flange adapter.
3. When mating to a rubber faced flange: the flange washer is placed between the Victaulic flange adapters and the rubber faced flange.
4. When mating C.I. flanges to IPS flanges: the flange washer is placed between two Victaulic flange adapters. If one flange is not a Victaulic flange adapter (e.g. a flanged valve), then a flanged gasket must be placed adjacent to that flange and the flange washer must be inserted between the flange gasket and the Victaulic flange adapter.
5. When mating to components (valves, strainers, etc.) where the component flange face has an insert: follow the same arrangement as in # 1 above.

When ordering Victaulic flange washers, always specify the *Vic-Flange* Adapter style number and size to assure the proper flange washer is supplied.

For additional notes regarding *Vic-Flange* Adapters, refer to publications 06.06, 06.32 and 20.04.

No. 65

Refer to Page 1-8 for prices.

END OF RUN FITTING IGS™ GROOVED OUTLET

Refer to publication 10.54



FireLock™ System for Grooved IPS Pipe

End of Run Fitting

NO. 67

Refer to publication 10.21



END OF RUN FITTING

Nominal Size inches		Approx. Weight Each lb	Price Each	
			Painted	Galv.
1¼	x ½ NPT	0.6	\$126.00	\$155.50
	¾ NPT	0.5	126.00	155.50
	1 NPT	0.6	126.00	155.50
1½	x ½ NPT	0.7	126.00	155.50
	¾ NPT	0.7	126.00	155.50
	1 NPT	0.7	126.00	155.50
2	x ½ NPT	0.7	134.00	176.00
	¾ NPT	0.7	134.00	176.00
	1 NPT	0.9	134.00	176.00
2½	x ½ NPT	1.3	158.50	192.00
	¾ NPT	1.2	158.50	192.00
	1 NPT	1.3	158.50	192.00
3	x ¾ NPT	2.0	208.50	257.00
	1 NPT	1.9	208.50	257.00

NOTE: Items listed in shaded areas are non-cancellable and non-returnable.

For FireLock™ IGS™ Groove No. 65 End-of-Run Fitting, refer to FireLock™ IGS™ Groove System Section of this book.

Drain Elbow

NO. 10-DR

Refer to publication 10.05

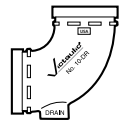

DRAIN ELBOW WITH 1" DRAIN

Nom. Size inches	Approx. Wgt. Ea. lb	Price Each	
		Painted	Galv.
2½	5.2	\$313.00	\$402.00
3	5.3	400.00	476.50
4	8.8	405.00	549.50
6	18.7	709.00	1008.00

FireLock™ System for Grooved IPS Pipe

Fire Protection Valves

FireLock™ Ball Valve

SERIES 728

Refer to publication 10.17



Threaded



Grooved



SERIES 728 – WITH WEATHERPROOF ACTUATOR

Nominal Size	T x T Ball Valve with Weatherproof Actuator †		G x G Ball Valve with Weatherproof Actuator † *	
	Approx. Wgt. Each lb	Price Each	Approx. Wgt. Each lb	Price Each
1	5.1	\$442.50	–	–
1¼	5.8	\$471.50	7.5	\$471.50
1½	6.6	\$558.50	8.5	\$558.50
2	8.5	\$674.00	10.5	\$674.00

* Grooved valve will come standard with a ½" NPT tap.

† Please specify choice of grooved or threaded ends on order.

V - 020 - 4 6 6 T - W2

Type	Act. In./mm	Size Code	Pressure Rating	Body/Ball	Seat	End Connection	Operator
V	1/25 1¼/32 1½/40 2/50	010 012 014 020	4 - 365 psi	6 - Bronze/Chrome Plated Brass	6 - Reinforced TFE	T - Threaded G - Grooved*	W2 - UL/ULC/FM Weatherproof Gear Operator w/2 SPDT Switches W9 - UL/FM Weatherproof Gear Operator with 2 SPDT Switches and Extra Long Wire Leads

* 1¼/32 mm, 1½/40 mm and 2/50 mm only

FireLock™ System for Grooved IPS Pipe

Butterfly Valve – Supervised OPEN

SERIES 705

(with weatherproof actuator)
Refer to publication 10.81



SERIES 705 BUTTERFLY VALVE

Nominal Size inches	WRD – Pre-wired without Tap		WRD – Pre-wired with Tap	
	Approx. Wgt. Each lb	Price Each	Approx. Wgt. Each lb	Price Each
2	8.2	\$826.00	8.2	\$906.50
2½	9.7	826.00	9.7	906.50
3	10.7	892.00	10.7	980.00
4	14.0	935.50	14.0	1026.50
5	25.4	1401.00	23.7	+
6	28.7	1328.50	28.7	1444.00
8	43.0	2035.50	43.0	2174.00
10	80.6	4924.50	–	–
12	94.6	7033.00	–	–

NOTE: Items listed in shaded areas are non-cancellable and non-returnable.

+ Quoted on application. Contact Victaulic for pricing and availability.

Weatherproof Actuator Replacement Kit

FOR SERIES 705 – SUPERVISED OPEN ONLY

(Consists of mounting bolt,
actuator, handwheel and assem-
bly hardware)
Refer to publication 10.81

GEAR OPERATOR REPAIR KIT FOR SERIES 705

Nominal Size inches	Part Code	Kit Price Each
2	K020705100	\$800.00
2½	K024705100	800.00
3	K030705100	800.00
4	K040705100	859.00
5	K050705100	859.00
6	K060705100	1041.00
8	K080705100	2205.00
10	K100705100	2869.00
12	K120705100	2869.00

NOTE: Items listed in shaded areas are non-cancellable and non-returnable.

FireLock™ System for Grooved IPS Pipe

Butterfly Valve – Supervised CLOSED

SERIES 707C

(with weatherproof actuator)
Refer to publication 10.75



SERIES 707C – PRE-WIRED

Nominal Size	WRD – Pre-wired without Tap		
	Approx. Wgt. Each lb	Part Code	Price Each
2	8.2	V020707900	\$1121.50
2½	9.7	V024707900	1121.50
3	10.7	V030707900	1212.50
4	14.0	V040707900	1270.00
5	25.4	V050707900	1901.50
6	28.7	V060707900	1804.00
8	43.0	V080707900	2760.50

NOTE: Items listed in shaded areas are non-cancellable and non-returnable.

High Pressure Butterfly Valve – Supervised OPEN

SERIES 765

(with Weatherproof Actuator)
Refer to publication 10.80



SERIES 765 GROOVED END HIGH PRESSURE BUTTERFLY VALVE

Nominal Size	Pre-wired without Tap		Pre-wired with Tap	
	Approx. Wgt. Each lb	Price Each	Approx. Wgt. Each lb	Price Each
2	9.5	\$1256.50	9.5	\$1362.50
2½	9.7	1300.50	9.7	1411.00
3	10.7	1406.00	10.7	1523.00
4	14.0	1473.00	14.0	1598.00
5	25.8	2204.50	25.8	2404.50
6	28.7	2091.00	28.7	2268.50
8	43.0	3202.00	43.0	3473.00
10	80.6	7751.00	–	–
12	94.6	11067.50	–	–

NOTE: Items listed in shaded areas are non-cancellable and non-returnable.

FireLock™ System for Grooved IPS Pipe

High Pressure Butterfly Valve – Supervised CLOSED

SERIES 766

(with Weatherproof Actuator)
Refer to publication 10.83



SERIES 766 GROOVED END HIGH PRESSURE BUTTERFLY VALVE

Nominal Size	Pre-wired without Tap		
	inches	Approx. Wgt. Each lb	Part Code
2	8.2	V020766900	\$1256.50
2½	9.7	V024766900	1300.50
3	10.7	V030766900	1406.00
4	14.0	V040766900	1473.00
5	25.4	V050766900	2204.50
6	28.7	V060766900	2091.00
8	43.0	V080766900	3202.00

NOTE: Items listed in shaded areas are non-cancellable and non-returnable.

FireLock™ System for Grooved IPS Pipe

Series 771A OS&Y (300 psi) Groove x Groove
 Series 771H OS&Y Groove x Groove
 Series 771F OS&Y Groove x Flange
 Series 772A NRS (300 psi) Groove x Groove
 Series 772H NRS Groove x Groove
 Series 772F NRS Groove x Flange
 Gate Valves

Refer to publication 10.92 or 10.72



Refer to Victaulic publication 10.01 for details.



Series 771H



Series 772H



Series 771F



Series 772F

Gate Valve Size inches	OS&Y			NRS				
	Approx. Weight Each lb	Series 771A Groove x Groove Price Each	Series 771H Groove x Groove Price Each	Series 771F Groove x Flange Price Each	Approx. Weight Each lb	Series 772A Groove x Groove Price Each	Series 772H Groove x Groove Price Each	Series 772F Groove x Flange Price Each
2½	30.6	\$1520.00	\$1381.50	\$1381.50	29.3	\$1407.50	\$1279.00	\$1279.00
3	36.0	1976.00	1796.00	1796.00	63.0	1890.00	1718.00	1718.00
4	77.0	2325.00	2113.50	2113.50	70.0	2249.50	2045.00	2045.00
6	144.0	3112.50	2829.50	2829.50	117.0	2884.50	2622.00	2622.00
8	170.0	4878.00	4435.00	4435.00	188.0	4259.00	3871.50	3871.50
10	344.7	6566.00	5969.00	5969.00	297.7	6187.50	5625.00	5625.00
12	489.5	10241.00	9309.50	9309.50	394.9	8656.50	7869.00	7869.00

NOTE: Items listed in shaded areas are non-cancellable and non-returnable.

Flange Mounting Kits
 for use with Series
 772H NRS Gate
 Valves

FLANGE MOUNTING KITS FOR USE WITH SERIES 772F NRS GATE VALVES

Gate Valve Size inches	Victaulic Part Code	Price Each
2½ – 3	K024772001	\$350.00 ^{NR}
4	K040772001	343.50
6 – 8	K060772001	413.50 ^{NR}
10	K100772001	638.50
12	K120772001	1290.50

HANDWHEELS FOR SERIES 772H AND 772F NRS GATE VALVES

Gate Valve Size inches	Victaulic Part Code	Price Each
3 – 4	K030772002	\$73.50 ^{NR}
6 – 8	K060772002	197.00 ^{NR}

NOTE: Items listed in shaded areas are non-cancellable and non-returnable.

^{NR} Non-returnable

FireLock™ System for Grooved IPS Pipe

Series 773 and Series 774 Post Indicators

SERIES 773 AND SERIES 774 POST INDICATORS



Series 773

Series 774



Description	Approx. Weight Ea. lb	Series 773 Wall Post Indicator Price Each
Series 773 Wall Post Indicator Wall Post Indicators include all hardware required to mount indicator to valve.	90.0	\$1677.50
Series 774 Upright Post Indicator	250.0	3659.00

Supervisory Switches

SUPERVISORY SWITCHES



Model	Description	Price Each
OSYSU-2	Outside Screw and Yoke Valve Supervisory Switch	\$479.00
PCVS	Post Indicator / Butterfly Valve Supervisory Switch	447.00
PTS-C	Plug-In Supervisory Switch	939.50

NOTE: Items listed in shaded areas are non-cancellable and non-returnable.

FireLock™ Check Valve

SERIES 717H

Refer to publication 10.08



SERIES 717H

Size inches	Approx. Weight Each lb	Price Each
2	5.8	\$487.00
2½	7.5	514.50
3	9.7	514.50

FireLock™ System for Grooved IPS Pipe

FireLock™ Check Valve

SERIES 717

Refer to publication 10.08



2½ and 3"



4 – 12"



SERIES 717

Size inches	Approx. Weight Each lb	Price Each
2½	3.6	\$514.50
3	3.6	514.50
4	20.0	535.00
5	27.0	1298.00
6	38.0	1330.00
8	64.0	2307.50
10	100.0	4395.50
12	140.0	5733.50

Threaded Ball Valve

SERIES 722

Refer to publication 08.15



SERIES 722

Nominal Size inches	Approx. Wgt. Each lb	Price Each
¼	0.2	\$77.50
½	0.4	101.00
¾	0.7	102.00
1	1.0	135.00
1¼	1.5	213.50
1½	2.1	263.50
2	2.4	350.00

FireLock™ System for Grooved IPS Pipe

FireLock™ Wye-Type Vic-Strainer

SERIES 732H

Refer to publication 10.68



SERIES 732H

Nominal Size		Approx. Weight Each	Price Each	
inches		lb	Galvanized *	Standard Basket Only
2		10.0	\$2697.00	\$1763.00
2½		14.0	2868.50	1837.00
3		20.0	3271.00	1598.00
4		32.0	3806.00	1660.50

NOTE: Items listed in shaded areas are non-cancellable and non-returnable.

* Vic-Strainer Series 732H standard components include galvanized body, access cap and coupling (Grade "E" EPDM, plated bolts and nuts) and Type 304 stainless steel basket (0.062" diameter holes for 2 – 3/50 – 80 mm sizes; and 0.188" diameter holes for 47/100 mm sizes). Contact Victaulic for details.

Alarm Test Module

SERIES 720

Refer to publication 10.22



Series 720T
with Threaded
Ends

Series 720G
with Grooved
Ends



ALARM TEST MODULE

Size		Style 720T NPT Threaded		Style 720G Grooved	
inches	Orifice	Approx. Wgt. Each lb	Price Each	Approx. Wgt. Each lb	Price Each
1	x ½	7.3	\$479.50	–	–
	17/32	7.3	479.50	–	–
1¼	x ½	6.9	550.50	6.6	\$550.50
	17/32	6.9	550.50	6.6	550.50
1½	x ½	9.0	897.00	8.5	897.00
	17/32	9.0	897.00	8.5	897.00
2	x ½	10.1	967.00	9.3	967.00
	17/32	10.1	967.00	9.3	967.00

NOTE: Items listed in shaded areas are non-cancellable and non-returnable.

Alarm Test Module

SERIES 720

WITH GAUGE PORT TAP

Refer to publication 10.22



ALARM TEST MODULE – WITH GAUGE PORT TAP

Size		Style 720T Threaded with Gauge Port Tap		Style 720G Grooved with Gauge Port Tap	
inches	Orifice	Approx. Wgt. Each lb	Price Each	Approx. Wgt. Each lb	Price Each
1	x ½	7.3	\$528.50	–	–
	17/32	7.3	528.50	–	–
1¼	x ½	6.9	599.00	6.6	\$599.00
	17/32	6.9	599.00	6.6	599.00
1½	x ½	9.0	948.50	8.5	948.50
	17/32	9.0	948.50	8.5	948.50
2	x ½	10.1	1017.00	9.3	1017.00
	17/32	10.1	1017.00	9.3	1017.00

NOTE: Items listed in shaded areas are non-cancellable and non-returnable.

FireLock™ System for Grooved IPS Pipe

Alarm Test Module

**SERIES 720
WITH PRESSURE RELIEF OPTION**
Refer to publication 10.22



ALARM TEST MODULE – WITH PRESSURE RELIEF OPTION

Size		Style 720T Threaded with Pressure Relief Option	
inches	Orifice	Approx. Wgt. Each lb	Price Each
1	x 1/2	7.3	\$710.00
	17/32	7.3	710.00
1 1/4	x 1/2	6.9	790.00
	17/32	6.9	790.00
1 1/2	x 1/2	9.0	1144.50
	17/32	9.0	1144.50
2	x 1/2	10.1	1189.50
	17/32	10.1	1189.50

NOTE: Items listed in shaded areas are non-cancellable and non-returnable.

Alarm Test Module

**SERIES 720
WITH PRESSURE RELIEF AND
GAUGE PORT OPTIONS**
Refer to publication 10.22

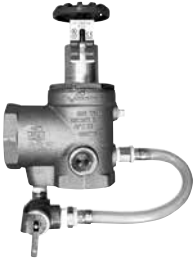

ALARM TEST MODULE – WITH PRESSURE RELIEF AND GAUGE PORT OPTIONS

Size		Style 720T Threaded with Pressure Relief and Gauge Port Option	
inches	Orifice	Approx. Wgt. Each lb	Price Each
1	x 1/2	7.3	\$760.50
	17/32	7.3	760.50
1 1/4	x 1/2	6.9	841.00
	17/32	6.9	841.00
1 1/2	x 1/2	9.0	1196.00
	17/32	9.0	1196.00
2	x 1/2	10.1	1242.00
	17/32	10.1	1242.00

NOTE: Items listed in shaded areas are non-cancellable and non-returnable.

Pressure Relief Valve Kit

**FOR SERIES 720 WITH
PRESSURE RELIEF OPTION**

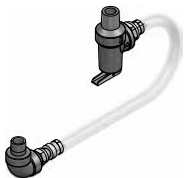

SERIES 720 PRESSURE RELIEF VALVE KIT

Riser Module Body Size	Victaulic Part Code	Price Each
Nominal inches		
1 – 2	V000720K01	\$360.00

FireLock™ System for Grooved IPS Pipe

Fire Pump Test Meter

SERIES 735 – MODEL S OR MODEL L

SERIES 735

Refer to publication 10.11



Nominal Size	Gallons Minute	Style 735 Model S		Style 735 Model L	
		Wgt. Ea. lb	Price Each	Wgt. Ea. lb	Price Each
2½ inches	100	9.0	\$14065.50	14.0	\$22701.50
2½ inches	150	9.0	14065.50	14.0	22701.50
3	200	10.0	15482.00	15.0	24275.50
4	250	12.0	17597.00	17.0	25277.50
4	300	12.0	17597.00	17.0	25277.50
4	450	12.0	17597.00	17.0	25277.50
5	500	13.0	19322.50	18.0	25399.50
6	750	15.0	21089.50	20.0	27655.50
6	1000	15.0	21089.50	20.0	27655.50
6	1250	15.0	21089.50	20.0	27655.50
8	1500	22.0	23894.00	27.0	30807.00
8	2000	22.0	23894.00	27.0	30807.00
8	2500	22.0	23894.00	27.0	30807.00
8	3000	22.0	23894.00	27.0	30807.00
10	3500	33.0	28462.00	38.0	35836.50
10	4000	33.0	28462.00	38.0	35836.50
10	4500	33.0	28462.00	38.0	35836.50
12	5000	66.0	35488.00	71.0	43898.50

NOTE: Items listed in shaded areas are non-cancellable and non-returnable.

Victaulic® Hydraulic Control Valves



Victaulic® Hydraulic Control Valves

Pressure Control Valves

Pressure Reducing Valve

SERIES 867-42T
BERMAD MODEL FP 42T
 Refer to publication 30.93



Nominal Size	High Built Epoxy Red (Standard) *			
	OGS		ANSI Class 300RF	
	Victaulic Part Code	Price Each	Victaulic Part Code	Price Each
1½	S014867T20	\$3012.00	–	–
2	S020867T20	3012.00	–	–
2½	S024867T20	3702.50	–	–
3	S030867T20	4598.00	S030867T30	\$7161.00
4	S040867T20	6414.50	S040867T30	8246.00
6	S060867T20	13138.00	S060867T30	13939.00
8	S080867T20	17575.00	S080867T30	17966.50
10	–	–	S100867T30	32634.50

NOTE: Items listed in shaded areas are non-cancellable and non-returnable.

* Other finishes and valve body materials available upon request.

Agency approvals, such as UL and FM, vary by size and end connection. Refer to publication 30.93 for details.

Pressure Reducing Valve

SERIES 867-7UL
BERMAD MODEL FP 720-UL
 Refer to publication 30.95



Nominal Size	Standard Polyester Red Coating (Standard) *							
	OGS		ANSI Class 150RF		ANSI Class 300RF		NPT	
	Victaulic Part Code	Price Each	Victaulic Part Code	Price Each	Victaulic Part Code	Price Each	Victaulic Part Code	Price Each
1½	S014867200	\$2729.00	S014867100	\$2811.00	S014867300	\$3577.00	–	–
2	S020867200	3015.00	S020867100	3105.50	S020867300	3787.50	S020867400	\$3760.00
2½	S024867200	3527.50	S024867100	3633.50	S024867300	4048.50	S024867400	4048.50
3	S030867200	3755.00	S030867100	3867.50	S030867300	4264.50	S030867400	4264.50
4	S040867200	4752.00	S040867100	4895.00	S040867300	5603.50	–	–
6	S060867200	8625.00	S060867100	8883.00	S060867300	9386.00	–	–
8	S080867200	13446.50	S080867100	13849.50	–	–	–	–
10	–	–	S100867100	37025.00	–	–	–	–
12	–	–	S120867100	51136.00	–	–	–	–

NOTE: Items listed in shaded areas are non-cancellable and non-returnable.

* Other finishes and valve body materials available upon request.

Agency approvals, such as UL and FM, vary by size and end connection. Refer to publication 30.93 for details.

Above pricing based on model FP-XXX-867-7UL-Y-CXX-PR-NN-66. All other configurations are priced on application.

Victaulic® Hydraulic Control Valves

Pressure Relief Valve and Suction Control Valve

SERIES 867-43T
SERIES 867-43T-PS
BERMAD MODEL FP 43T
 Refer to publication 30.93



Nominal Size inches	High Built Epoxy Red (Standard) *				
	OGS		Price Each	ANSI Class 300	
	Victaulic Part Code	TPS †		Victaulic Part Code	TPS †
1½	S0148672T0	S0148672TS	\$3720.50	-	-
2	S0208672T0	S0208672TS	3720.50	-	-
2½	S0248672T0	S0248672TS	4617.50	-	-
3	S0308672T0	S0308672TS	5514.50	S0308673T0	S0308673TS
4	S0408672T0	S0408672TS	7154.50	S0408673T0	S0408673TS
6	S0608672T0	S0608672TS	9519.00	S0608673T0	S0608673TS
8	S0808672T0	S0808672TS	13280.50	S0808673T0	S0808673TS
10	-	-	-	-	S1008673TS
12	-	-	-	-	S1208673TS

NOTE: Items listed in shaded areas are non-cancellable and non-returnable.

* Other finishes and valve body materials available upon request.

Agency approvals, such as UL and FM, vary by size and end connection. Refer to publication 30.93 for details.

† Indicates pump suction.

Pressure Relief Valve

SERIES 867-4UF
BERMAD MODEL FP 430-UF
 Refer to publication 30.93



Nominal Size inches	High Built Epoxy Red (Standard) *				
	OGS		ANSI Class 150RF		NPT
	Victaulic Part Code	Price Each	Victaulic Part Code	Price Each	Victaulic Part Code
2	S020867240	\$4202.50	S020867140	\$4222.00	S020867440
3	S030867240	5355.50	S030867140	5488.50	-
4	S040867240	7132.00	S040867140	6886.50	-
6	S060867240	11974.50	S060867140	11871.00	-
8	S080867240	15090.00	S080867140	15253.00	-
10	-	-	S100867140	23734.00	-
12	-	-	S120867140	34478.00	-

NOTE: Items listed in shaded areas are non-cancellable and non-returnable.

* Other finishes and valve body materials available upon request.

Agency approvals, such as UL and FM, vary by size and end connection. Refer to publication 30.93 for details.

Above pricing based on model FP-XXX-867-4UF-G-C-ER-NN. All other configurations are priced on application.

Victaulic® Hydraulic Control Valves

Pressure Relief Valve

SERIES 867-7UF
BERMAD MODEL FP 730-UF
 Refer to publication 30.95

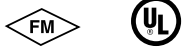
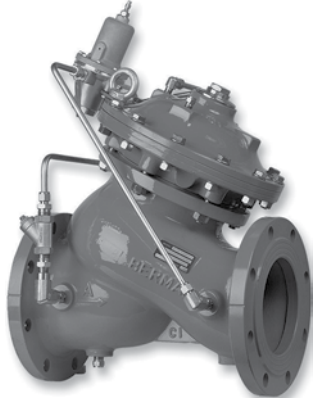

Nominal Size	Standard Polyester Red Coating (Standard) *									
	OGS		ANSI Class 150RF		ANSI Class 150RF Angled		ANSI Class 300RF		NPT	
	Victaulic Part Code	Price Each	Victaulic Part Code	Price Each	Victaulic Part Code	Price Each	Victaulic Part Code	Price Each	Victaulic Part Code	Price Each
1½	S014867270	\$5908.00	S014867170	\$5908.00	S014867171	\$5908.00	-	-	-	-
2	S020867270	4525.00	S020867170	4525.00	S020867171	4525.00	S020867370	\$4524.00	S020867470	\$4520.50
2½	S024867270	4552.50	S024867170	4552.50	S024867171	4552.50	-	-	S024867470	4562.50
3	S030867270	5843.00	S030867170	5879.00	S030867171	5879.00	S030867370	5789.00	-	-
4	S040867270	8800.50	S040867170	8954.00	S040867171	8954.00	S040867370	8813.00	-	-
6	S060867270	14313.50	S060867170	15071.50	S060867171	15071.50	S060867370	14550.00	-	-
8	S080867270	20865.00	S080867170	21728.50	S080867171	21728.50	-	-	-	-
10	-	-	S100867170	37754.50	S100867171	37754.50	-	-	-	-
12	-	-	S120867170	53792.00	S120867171	53792.00	-	-	-	-

NOTE: Items listed in shaded areas are non-cancellable and non-returnable.

* Other finishes and valve body materials available upon request.

Agency approvals, such as UL and FM, vary by size and end connection. Refer to publication 30.93 for details.

Above pricing based on model FP-XXX-867-7UF-X-C-XX-PR-NN. All other configurations are priced on application.

Direct Acting Pressure Relief Valve/Fire Pump Casing Relief Valve

SERIES 867-3HC
BERMAD MODEL FP 3HC-0
 Refer to publication 30.98

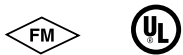

In-field Adjustment psi	Victaulic Part Code	Price Each
15 – 235	S0068671HC	\$773.00
100 – 365	S0068673HC	985.00

NOTE: Items listed in shaded areas are non-cancellable and non-returnable.

* Other finishes and valve body materials available upon request.

Agency approvals, such as UL and FM, vary by size and end connection. Refer to publication 30.93 for details.

Victaulic® Hydraulic Control Valves

Level Control Valves

Level Control BERMAD Valve

**SERIES 866-460
BERMAD FP-450-60**

with Modulating Horizontal Float
Refer to publication 30.94



Nominal Size inches	High Built Epoxy Red (Standard) *	
	Victaulic Part Code	Price Each
2	S020866260	\$4319.00
3	S030866260	5696.00
4	S040866260	7275.00
6	S060866260	11760.00
8	S080866260	17018.00

NOTE: Items listed in shaded areas are non-cancellable and non-returnable.

* Other finishes and valve body materials available upon request.

End connection is not differentiated by price. OGS, Class 150RF flange and NPT available.

Above pricing based on model FP-XXX-866-460-G-C-XX-ER-NN. All other configurations are priced on application.

Level Control BERMAD Valve

**SERIES 866-465
BERMAD FP-450-65**

with Bi-Level Electric Float



Nominal Size inches	High Built Epoxy Red (Standard) *	
	Victaulic Part Code	Price Each
2	S020866265	\$5128.50
3	S030866265	6496.00
4	S040866265	8078.00
6	S060866265	12550.50
8	S080866265	17841.50

NOTE: Items listed in shaded areas are non-cancellable and non-returnable.

* Other finishes and valve body materials available upon request.

End connection is not differentiated by price. OGS, Class 150RF flange and NPT available.

Above pricing based on model FP-XXX-866-465-G-C-XX-ER-4DC-NN. All other configurations are priced on application.

Victaulic® Hydraulic Control Valves

Level Control BERMAD Valve

SERIES 866-466
BERMAD FP-450-66

with Vertical Float



Nominal Size inches	High Built Epoxy Red (Standard) *	
	Victaulic Part Code	Price Each
2	S020866266	\$6932.00
3	S030866266	7832.00
4	S040866266	9410.50
6	S060866266	13952.00
8	S080866266	18704.50

NOTE: Items listed in shaded areas are non-cancellable and non-returnable.

* Other finishes and valve body materials available upon request.

End connection is not differentiated by price. OGS, Class 150RF flange and NPT available.

Above pricing based on model FP-XXX-866-466-G-C-ER-NN. All other configurations are priced on application.

Level Control BERMAD Valve

SERIES 866-482
BERMAD FP-450-82

with Altitude Pilot



Nominal Size inches	High Built Epoxy Red (Standard) *	
	Victaulic Part Code	Price Each
2	S020866282	\$6932.00
3	S030866282	7832.00
4	S040866282	9410.50
6	S060866282	13952.00
8	S080866282	18704.50

NOTE: Items listed in shaded areas are non-cancellable and non-returnable.

* Other finishes and valve body materials available upon request.

End connection is not differentiated by price. OGS, Class 150RF flange and NPT available.

Above pricing based on model FP-XXX-866-482-M6-G-C-XX-ER-NN. All other configurations are priced on application.

Hole Cut Products



Hole Cut Products

Mechanical-T Outlet

STYLES 920/920N

Refer to publication 11.02



Style 920 Female



STYLE 920 – FEMALE THREADED BRANCH

Size	Style	COMPLETE MECHANICAL-T Female Threaded Branch †			Spare Parts			
		Approx. Wgt. Ea. lb	Price Each		Bolts & Nuts Size inches	Standard Grade “E” or “T” Gaskets		
inches Run x Brch.	Number		Painted	Galv.				
2	x	1/2	920N	3.1	\$126.00	\$157.50	1/2 x 2 3/4	\$28.00
		3/4	920N	3.1	126.00	157.50	1/2 x 2 3/4	28.00
		1	920N	3.0	126.00	157.50	1/2 x 2 3/4	28.00
		1 1/4	920N	3.5	145.00	179.00	1/2 x 2 3/4	32.50
		1 1/2	920N	3.6	145.00	179.00	1/2 x 2 3/4	32.50
2 1/2	x	1/2	920N	3.0	126.00	157.50	1/2 x 2 3/4	28.00
		3/4	920N	3.0	126.00	157.50	1/2 x 2 3/4	28.00
		1	920N	2.9	126.00	157.50	1/2 x 2 3/4	28.00
		1 1/4	920N	3.5	176.00	213.50	1/2 x 3 1/4	32.50
		1 1/2	920N	3.6	176.00	213.50	1/2 x 3	32.50
3	x	1/2	920N	3.4	145.00	176.00	1/2 x 2 3/4	28.00
		3/4	920N	3.4	145.00	176.00	1/2 x 2 3/4	28.00
		1	920N	3.3	145.00	176.00	1/2 x 2 3/4	28.00
		1 1/4 §	920N	3.8	181.50	227.00	1/2 x 2 3/4	32.50
		1 1/2 §	920N	4.1	181.50	227.00	1/2 x 2 3/4	32.50
		2 §	920N	4.9	209.50	259.50	1/2 x 3 1/4	32.50
4	x	1/2	920N	3.7	181.00	216.00	1/2 x 2 3/4	28.00
		3/4	920N	3.7	181.00	216.00	1/2 x 2 3/4	28.00
		1	920N	3.6	181.00	216.00	1/2 x 2 3/4	28.00
		1 1/4	920N	4.0	211.50	250.50	1/2 x 2 3/4	32.50
		1 1/2	920N	4.2	220.00	276.50	1/2 x 2 3/4	32.50
		2	920N	5.0	220.00	279.00	1/2 x 2 3/4	32.50
		2 1/2	920	5.8	229.50	296.50	1 x 2 3/4	36.00
		3	920	8.4	244.00	313.00	1 x 3 1/4	39.50
5	x	1 1/2	920	7.7	268.00	339.50	5/8 x 4 3/4	32.50
		2	920	8.2	268.00	339.50	5/8 x 4 3/4	32.50
		2 1/2	920	8.3	282.50	360.00	5/8 x 4 3/4	36.00
		3	920	8.4	301.00	386.00	5/8 x 4 3/4	39.50
6	x	1 1/4	920N	–	–	–	1/2 x 2 3/4	32.50
		1 1/2	920N	5.1	275.00	351.00	1/2 x 2 3/4	32.50
		2	920N	5.6	275.00	351.00	1/2 x 2 3/4	32.50
		2 1/2	920	7.6	296.00	382.00	5/8 x 4 3/4	36.00
		3	920	8.4	314.00	403.00	5/8 x 4 3/4	39.50
		4	920	10.1	349.00	452.00	5/8 x 4 3/4	52.00
8	x	2	920	11.6	479.00	602.50	3/4 x 4 1/4	37.50
		2 1/2	920	11.6	479.00	602.50	3/4 x 4 1/4	37.50
		3	920	12.6	504.50	639.00	3/4 x 4 1/4	39.50
		4	920	15.3	519.50	669.50	3/4 x 4 1/4	52.00

NOTE: Items listed in shaded areas are non-cancellable and non-returnable.

Victaulic Hole Cutting Tool available, designed specifically for cutting holes to receive Mechanical-T outlet. See Pipe Preparation Tool Section for information.

† Some size Mechanical-T outlets are available with British Standard Pipe Threads (BSPT) female threaded outlets. Contact Victaulic for details.

§ Requires 1/2 x 3 3/4" bolts when used in cross configuration.

For FireLock™ IGS™ Groove Style 920N Mechanical-T Outlet sizes 2 x 1, 2 1/2 x 1, 3 x 1, and 4 x 1, refer to FireLock™ IGS™ Groove System Section in this book.

Hole Cut Products

Mechanical-T Outlet

STYLES 920/920N

Refer to publication 11.02



Style 920 Grooved



STYLES 920/920N GROOVED MECHANICAL-T OUTLET

Size inches Run x Branch	Style Number	Approx. Wgt. Ea. lb	COMPLETE MECHANICAL-T Grooved Branch		Spare Parts	
			Price Each		Bolts & Nuts Size inches	Standard Grade "E" or "T" Gaskets
			Painted	Galv.		
2 x 1	920N	-	-	-	-	\$28.00
	920N	3.2	\$145.00	\$179.00	1/2 x 2 3/4	32.50
	920N	3.2	145.00	179.00	1/2 x 2 3/4	32.50
2 1/2 x 1	920N	-	-	-	-	28.00
	920N	3.2	176.00	213.50	1/2 x 3 1/4	32.50
	920N	3.3	176.00	213.50	1/2 x 3	32.50
3 x 1	920N	-	-	-	-	28.00
	920N §	3.7	181.50	227.00	1/2 x 2 3/4	32.50
	920N §	3.8	181.50	227.00	1/2 x 2 3/4	32.50
	920N §	4.6	209.50	259.50	1/2 x 3 1/4	32.50
3 1/2 x 2	920N	3.8	806.00	1006.00	1/2 x 2 3/4	32.50
4 x 1	920N	1.6	-	-	-	28.00
	920N	3.6	211.50	250.50	1/2 x 2 3/4	32.50
	920N	3.9	220.00	276.50	1/2 x 2 3/4	32.50
	920N	4.6	220.00	279.00	1/2 x 2 3/4	32.50
	920	5.0	229.50	296.50	1/2 x 2 3/4	36.00
	920	6.4	244.00	313.00	1/2 x 3 1/4	39.50
5 x 1 1/2	920	7.6	268.00	339.50	5/8 x 4 3/4	32.50
	920	8.0	268.00	339.50	5/8 x 4 3/4	32.50
	920	7.9	282.50	360.00	5/8 x 4 3/4	36.00
	920	8.8	301.00	386.00	5/8 x 4 3/4	39.50
6 x 1 1/4	920N	4.8	275.00	351.00	1/2 x 2 3/4	32.50
	920N	5.1	275.00	351.00	1/2 x 2 3/4	32.50
	920N	5.6	275.00	351.00	1/2 x 2 3/4	32.50
	920	7.6	301.00	382.00	5/8 x 4 3/4	36.00
	920	8.4	314.00	403.00	5/8 x 4 3/4	39.50
	920	10.1	349.00	452.00	5/8 x 4 3/4	52.00
8 x 2	920	11.6	479.00	602.50	3/4 x 4 1/4	37.50
	920	11.6	479.00	602.50	3/4 x 4 1/4	37.50
	920	11.6	504.50	639.00	3/4 x 4 1/4	39.50
	920	12.5	519.50	669.50	3/4 x 4 1/4	52.00

NOTE: Items listed in shaded areas are non-cancellable and non-returnable.

Victaulic Hole Cutting Tool available, designed specifically for cutting holes to receive Mechanical-T outlet. See Pipe Preparation Tool Section for information.

§ Requires 1/2 x 3 1/4" bolts when used in cross configuration.

For FireLock™ IGS™ Groove Style 920N Mechanical-T Outlet sizes 2 x 1, 2 1/2 x 1, 3 x 1, and 4 x 1, refer to FireLock™ IGS™ Groove System Section in this book.

Hole Cut Products

Vic-Tap II

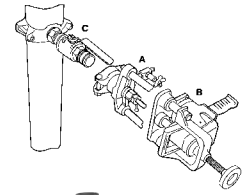

* Parts A and B are designed for use with Style 931 Vic-Tap II Mechanical-T units; (Part C) for tapping into systems under pressure up to 500 psi.

Part "A" Includes drill guide base with extended shaft, arbor, pilot drill, 2 $\frac{3}{8}$ " hole saw, packing gland and HP-70 Rigid Coupling for connection to Vic-Tap II.

Part "B" Includes drill motor with ground fault interrupt and clip-on feed wheel assembly.

Part "C" Vic-Tap II with 2 $\frac{1}{2}$ " full port ball valve factory mounted. Available in sizes 4 x 2 $\frac{1}{2}$ ", 5 x 2 $\frac{1}{2}$ ", 6 x 2 $\frac{1}{2}$ ", and 8 x 2 $\frac{1}{2}$ ". Available for purchase only (parts not sold separately).

* Parts A & B can be purchased separately.

Tool Model	Part Number	Shipping Weight lb	Rental Per Month	List Price
Vic-Tap II - Parts A and B only	R000902VT2	70	\$6470.50	\$14215.00
Part A only	R100902VT2	-	-	9696.50
Part B only	R300901VT1	-	-	9669.00
Part C †				
4 x 2 $\frac{1}{2}$ " / 100 x 65 mm	R016931010	-	-	2850.00
5 x 2 $\frac{1}{2}$ " / 125 x 65 mm	R020931010	-	-	2850.00
6 x 2 $\frac{1}{2}$ " / 150 x 65 mm	R024931010	-	-	2850.00
8 x 2 $\frac{1}{2}$ " / 200 x 65 mm	R032931010	-	-	2850.00

NOTE: For this application, a ground fault interrupt **MUST** be used. Available for purchase at **\$1014.00**. Part. No. N-E15-000-004.

NOTE: 40"/1016 mm minimum clearance is required for the Vic-Tap II.

† Part C available galvanized. Contact Victaulic for pricing and delivery.

NOTE: Items listed in shaded areas are non-cancellable and non-returnable.

Hole Cut Products

Mechanical-T Cross

STYLE 920/920N *

Refer to publication 11.03



The following combinations of *Mechanical-T* Crosses can be achieved with the use of two *Mechanical-T* Upper Housings of the same run size and the same or different outlet size. Most sizes of *Mechanical-T* outlets are available with either grooved or female threaded outlets. Your choice must be specified on each order.

STYLES 920/920N MECHANICAL-T CROSS

Nominal Size inches				Style		COMPLETE <i>MECHANICAL-T</i> Cross with "E" or "T" Gasket †		
Run x Branch				Number		Painted	Galv.	
		A	B					
2	x	2	x	1/2	1/2	920N	\$196.50	\$251.50
				1/2	3/4	920N	225.00	287.00
				1/2	1	920N	196.50	251.50
				1/2	1 1/4	920N	225.00	287.00
				1/2	1 1/2	920N	225.00	287.00
				3/4	3/4	920N	196.50	287.00
				3/4	1	920N	196.50	251.50
				3/4	1 1/4	920N	225.00	287.00
				3/4	1 1/2	920N	225.00	287.00
				1	1	920N	196.50	251.50
				1	1 1/4	920N	225.00	287.00
				1	1 1/2	920N	225.00	287.00
				1 1/4	1 1/4	920N	225.00	287.00
				1 1/2	1 1/4	920N	225.00	287.00
2 1/2	x	2 1/2	x	1/2	1/2	920N	196.50	251.50
				1/2	3/4	920N	196.50	251.50
				1/2	1	920N	196.50	251.50
				1/2	1 1/4	920N	269.00	348.00
				1/2	1 1/2	920N	269.00	369.50
				3/4	3/4	920N	196.50	251.50
				3/4	1	920N	196.50	251.50
				3/4	1 1/4	920N	269.00	348.00
				3/4	1 1/2	920N	269.00	369.50
				1	1	920N	196.50	251.50
				1	1 1/4	920N	269.00	348.00
				1	1 1/2	920N	269.00	348.00
				1 1/4	1	920N	269.00	348.00
				1 1/4	1 1/4	920N	269.00	348.00
1 1/2	1	920N	269.00	348.00				
1 1/2	1 1/4	920N	269.00	348.00				
1 1/2	1 1/2	920N	269.00	287.00				
3	x	3	x	1/2	1/2	920N	220.00	282.50
				1/2	3/4	920N	220.00	282.50
				1/2	1	920N	269.00	335.00
				1/2	1 1/4 §	920N	269.00	335.00
				1/2	1 1/2 §	920N	269.00	335.00
				1/2	2 §	920N	311.00	384.00

* Style 920 and Style 920N housings cannot be mated to achieve cross connections. Refer to publication 11.03, or contact Victaulic for details.

‡ Available grooved only.

NOTE: Items listed in shaded areas are non-cancellable and non-returnable.

† Some size Mechanical-T outlets are available with British Standard Pipe Threads (BSPT) female threaded outlets. Contact Victaulic for details.

§ Requires 1/2 x 3/4" bolts when used in cross configuration.

Hole Cut Products

Nominal Size inches						Style		COMPLETE MECHANICAL-T Cross with "E" or "T" Gasket †					
Run x Branch						Number	Painted	Galv.					
		A	B										
3	x	3	x	¾	x	¾	920N	\$220.00	\$282.50				
				¾	x	1	920N	269.00	335.00				
				¾	x	1¼	920N	269.00	335.00				
				¾	x	1½	920N	269.00	335.00				
				¾	x	2	920N	311.00	384.00				
				1	x	1	920N	220.00	282.50				
				1	x	1¼	920N	269.00	269.00				
				1	x	1½	920N	269.00	335.00				
				1	x	2	920N	311.00	384.00				
				1¼	x	1¼ §	920N	269.00	335.00				
				1½	x	1¼ §	920N	269.00	335.00				
				1½	x	1½ §	920N	269.00	335.00				
				2	x	1¼ §	920N	311.00	350.00				
				2	x	1½	920N	311.00	384.00				
				2	x	2 §	920N	311.00	384.00				
				4	x	4	x	½	x	½	920N	269.00	349.50
								½	x	¾	920N	269.00	349.50
½	x	1	920N					269.00	349.50				
½	x	1¼	920N					325.50	408.50				
½	x	1½	920N					325.50	408.50				
½	x	2	920N					349.50	411.00				
¾	x	¾	920N					269.00	349.50				
¾	x	1	920N					269.00	349.50				
¾	x	1¼	920N					325.50	408.50				
¾	x	1½	920N					325.50	408.50				
¾	x	2	920N					349.50	411.00				
1	x	1	920N					269.00	349.50				
1	x	1¼	920N					325.50	411.00				
1	x	1½	920N					349.50	408.50				
1	x	2	920N					349.50	411.00				
1¼	x	1¼	920N					325.50	408.50				
1½	x	1¼	920N					325.50	408.50				
1½	x	1½	920N					325.50	408.50				
2	x	1¼	920N					349.50	411.00				
2	x	1½	920N					349.50	411.00				
2	x	2	920N					349.50	411.00				
2½	x	2½	920	349.50	442.50								
3	x	2½	920	363.00	469.00								
3	x	3	920	363.00	469.00								

* Style 920 and Style 920N housings cannot be mated to achieve cross connections. Refer to publication 11.03, or contact Victaulic for details.

‡ Available grooved only.

NOTE: Items listed in shaded areas are non-cancellable and non-returnable.

† Some size Mechanical-T outlets are available with British Standard Pipe Threads (BSPT) female threaded outlets. Contact Victaulic for details.

§ Requires ½ x 3¼" bolts when used in cross configuration.

Hole Cut Products

Nominal Size inches				Style		COMPLETE <i>MECHANICAL-T</i> Cross with "E" or "T" Gasket †			
Run x Branch				Number		Painted	Galv.		
		A	B						
5	x	5	x	1½	x	1½	920	\$399.00	\$504.50
				2	x	1½	920	419.00	504.50
				2	x	2	920	399.00	504.50
				2½	x	1½	920	419.00	533.50
				2½	x	2	920	419.00	533.50
				2½	x	2½	920	419.00	533.50
				3	x	1½	920	449.00	574.00
				3	x	2	920	449.00	574.00
				3	x	2½	920	449.00	574.00
				3	x	3	920	449.00	574.00
6	x	6	x	1¼ ‡	x	1¼ ‡	920N	408.00	524.00
				1½	x	1¼ ‡	920N	408.00	524.00
				1½	x	1½	920N	408.00	524.00
				2	x	1½	920N	408.00	524.00
				2	x	2	920N	425.00	564.50
				2½	x	2½	920	437.50	564.50
				3	x	2½	920	467.00	598.50
				3	x	3	920	467.00	598.50
				4	x	2½	920	516.50	669.50
				4	x	3	920	516.50	669.50
8	x	8	x	2	x	2	920	714.00	900.00
				2½	x	2	920	714.00	900.00
				2½	x	2½	920	714.00	900.00
				3	x	2½	920	750.50	955.00
				3	x	3	920	750.50	955.00
				4	x	2½	920	776.50	1003.50
				4	x	3	920	776.50	1003.50
4	x	4	920	776.50	1003.50				

NOTE: Items listed in shaded areas are non-cancellable and non-returnable.

* Style 920 and Style 920N housings cannot be mated to achieve cross connections. Refer to publication 11.03, or contact Victaulic for details.

‡ Available grooved only.

† Some size Mechanical-T outlets are available with British Standard Pipe Threads (BSPT) female threaded outlets. Contact Victaulic for details.

§ Requires ½ x 3¼" bolts when used in cross configuration.

Hole Cut Products

Outlet Tee

STYLE 922

Refer to publication 10.52



STYLE 922 – GRADE “E” EPDM TYPE A GASKET

Nominal Size inches	Approx. Wgt. Ea.	COMPLETE OUTLET-TEE Grade “E” Type A Gasket	
		Price Each	
Run x Branch	lb	Painted	Plated
1¼ x ½	1.07	\$29.00	\$54.50
	1.17	29.00	54.50
	1.20	29.00	58.00
1½ x ½	1.15	29.00	54.50
	1.20	29.00	54.50
	1.42	29.00	59.00
2 x ½	1.30	29.00	59.00
	1.37	29.00	59.00
	1.50	32.00	66.00
2½ x ½	1.40	34.00	66.00
	1.50	34.00	66.00
	1.65	34.00	68.00

For FireLock™ IGS™ Groove Style 9202 Outlet Tee sizes 1¼ x 1, 1½ x 1, 2 x 1, and 2½ x 1, refer to FireLock™ IGS™ Groove System Section in this book.

FireLock™ IGS Grooved Outlet-T and *Mechanical-T* Outlet

STYLE 922 AND STYLE 920N



For FireLock™ IGS Groove Style 922 Outlet-T and Style 920N *Mechanical-T* Outlet, refer to FireLock™ IGS Groove System Section page 1-4 in this book.

Hole Cut Products

Strapless Outlet

STYLE 923

Refer to publication 11.05



4 – 8"



10" and larger



STRAPLESS OUTLET – WITH GRADE “E” GASKET

Nominal Size	COMPLETE STRAPLESS OUTLET With “E” or “T” Gasket *	
	NPT IPS Outlet	
inches	Approx. Wgt. Per Unit lb	Price Per Unit
4 – 8 x 1/2	1.9	\$311.00
4 – 8 x 3/4	1.6	331.50
10 and larger x 1/2	1.9	311.00
10 and larger x 3/4	1.6	331.50

* Available with Grade “T” Gasket. Contact Victaulic for details.

NOTE: Items listed in shaded areas are non-cancellable and non-returnable.



Couplings, Spare Parts and Fittings



Couplings, Spare Parts and Fittings

Grooved IPS Pipe Couplings

Zero-Flex™ Rigid Coupling

STYLE 07

(with Style 77 gasket)
Refer to publication 06.02



STYLE 07 – GRADE “E” OR “T” GASKET OR FLUSH-SEAL™ GASKET

PIPE		Approx. Wgt. Ea.	COUPLING COMPLETE † With Grade “E” or “T” Gasket		COUPLING COMPLETE † with Flush-Seal Grade “E” or “T” Gasket		SPARE PARTS	
inches			Price Each		Price Each		Plated Bolt & Nut	
Nom. Size	Outside Dia.	lb	Painted	Galv.	Painted	Galv.	No. *	Size ‡ Inches
1	1.315	1.6	\$105.00	\$131.50	\$148.00	\$176.50	2	3/8 x 2
1¼	1.660	1.6	98.00	123.50	139.00	165.00	2	3/8 x 2
1½	1.900	1.6	105.00	131.50	148.00	176.50	2	3/8 x 2
2	2.375	2.3	134.00	166.50	175.50	208.50	2	½ x 2½
2½	2.875	2.6	151.50	191.50	209.50	245.00	2	½ x 2¾
3	3.500	3.0	176.00	222.50	221.50	270.50	2	½ x 2½
4	4.500	5.3	243.50	313.00	308.50	380.50	2	½ x 2¾
5	5.563	7.4	313.00	408.50	487.50	856.50	2	5/8 x 3¼
6	6.625	8.3	413.50	535.00	573.00	701.00	2	5/8 x 3¼
8	8.625	15.1	649.00	843.50	757.50	947.50	2	¾ x 4¼
10	10.750	23.5	1260.00	1681.00	1514.00	1921.50	2	7/8 x 6½
12	12.750	28.2	1407.50	1883.50	1721.00	2213.00	2	7/8 x 6½

NOTE: Items listed in shaded areas are non-cancellable and non-returnable.

† Surcharge for couplings supplied without gasket. Contact Victaulic for pricing.

‡ Metric thread size bolts available. Contact Victaulic.

NOTE: See Spare Parts Section for spare part prices.

QuickVic™ Flexible Coupling for Steel

STYLE 177N

Refer to publication 06.24



STYLE 177N – GRADE “EHP” OR “T” GASKET

PIPE		Approx. Wgt. Ea.	COUPLING COMPLETE † With Grade “EHP” or “T” Gasket		SPARE PARTS Grade “EHP” or “T” Gasket
inches			Price Each		
Nom. Size	Outside Dia.	lb	Painted	Galv.	
2	2.375	3.3	\$116.00	\$151.50	\$90.50 ^{NR}
2½	2.875	3.8	134.50	186.50	98.00 ^{NR}
3	3.500	4.3	148.00	204.50	111.00 ^{NR}
4	4.500	7.4	213.50	299.50	148.00 ^{NR}
5	5.563	10.0	340.00	487.50	221.50 ^{NR}
6	6.625	12.8	379.00	541.50	246.50 ^{NR}
8	8.625	20.7	650.50	965.50	296.50 ^{NR}

NOTE: Items listed in shaded areas are non-cancellable and non-returnable.

† Surcharge for couplings supplied without gasket. Contact Victaulic for pricing.

NOTE: Available with stainless steel bolts and nuts. Contact Victaulic for pricing.

^{NR} Non-returnable

Couplings, Spare Parts and Fittings

Standard Coupling

STYLE 77

Refer to publication 06.04



STYLE 77 – GRADE “E” OR “T” GASKET OR FLUSH-SEAL™ GASKET

PIPE		Approx. Wgt. Ea.	COUPLING COMPLETE † With Grade “E” or “T” Gasket		COUPLING COMPLETE † With Flush-Seal Grade “E” or “T” Gasket		SPARE PARTS	
inches			Price Each		Price Each		Plated Bolt & Nut	
Nom. Size	Outside Dia.		Painted	Galv.	Painted	Galv.	No.*	Size ‡ Inches
¾	1.050	1.1	\$77.00	\$102.00	\$118.00	\$145.00	2	¾ x 2
1	1.315	1.2	77.00	102.00	118.00	145.00	2	¾ x 2
1¼	1.660	2.0	99.50	131.50	145.00	178.00	2	½ x 2½
1½	1.900	2.1	108.00	140.00	151.00	186.50	2	½ x 2½
2	2.375	2.6	116.00	151.50	157.50	196.50	2	½ x 2½
2½	2.875	3.1	134.50	186.50	191.50	243.00	2	½ x 2¾
3	3.500	3.7	148.00	204.50	197.00	255.00	2	½ x 2¾
3½	4.000	5.6	211.50	296.00	283.50	372.00	2	⅝ x 3¼
4	4.500	6.7	213.50	299.50	284.00	372.00	2	⅝ x 3¼
5	5.563	10.6	320.50	459.00	493.50	640.00	2	¾ x 4¼
6	6.625	12.0	379.00	541.50	548.50	718.50	2	¾ x 4¼
8	8.625	20.8	613.50	910.50	738.00	1011.00	2	7/8 x 5
10	10.750	27.8	998.00	1428.50	1183.00	1589.50	2	1 x 6
12	12.750	31.1	1134.00	1621.50	1389.50	1828.00	2	1 x 6½

* Number of bolts equals number of segments supplied.

NOTE: Items listed in shaded areas are non-cancellable and non-returnable.

† Surcharge for couplings supplied without gasket. Contact Victaulic for pricing.

‡ Metric thread size bolts available. Contact Victaulic.

NOTE: See Spare Parts Section for spare part prices.

Flexible Coupling

STYLE 75

Refer to publication 06.05



STYLE 75 – GRADE “E” OR “T” GASKET OR FLUSH-SEAL™ GASKET

PIPE		Approx. Wgt. Ea.	COUPLING COMPLETE † With Grade “E” or “T” Gasket		COUPLING COMPLETE † With Flush-Seal Grade “E” or “T” Gasket		SPARE PARTS
inches			Price Each		Price Each		Plated Bolt & Nut
Nom. Size	Outside Dia.		Painted	Galv.	Painted	Galv.	Size ‡ Inches
1	1.315	1.3	\$77.50	\$95.50	\$121.00	\$142.50	¾ x 2
1¼	1.660	1.4	78.50	102.00	127.00	151.00	¾ x 2
1½	1.900	1.5	95.50	118.00	138.00	164.50	¾ x 2
2	2.375	1.7	116.00	151.50	142.50	170.00	¾ x 2
2½	2.875	1.9	134.50	186.50	170.00	200.00	¾ x 2
3	3.500	2.9	148.00	204.50	178.50	215.00	½ x 2¾
4	4.500	4.1	213.50	299.50	253.50	311.00	½ x 2¾
5	5.563	5.8	320.50	459.00	430.00	511.50	⅝ x 3¼
6	6.625	7.0	379.00	541.50	474.50	576.00	⅝ x 3¼
8	8.625	12.4	613.50	910.50	788.00	943.50	¾ x 4¼

NOTE: Items listed in shaded areas are non-cancellable and non-returnable.

† Surcharge for couplings supplied without gasket. Contact Victaulic for pricing.

‡ Metric thread size bolts available. Contact Victaulic.

NOTE: See Spare Parts Section for spare part prices.

Couplings, Spare Parts and Fittings

Reducing Coupling

STYLE 750

Refer to publication 06.08

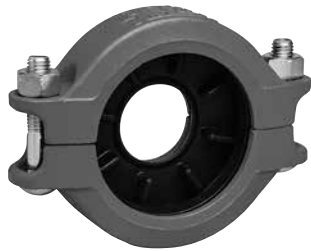

STYLE 750 – GRADE “E” OR “T” GASKET

PIPE		Approx. Wgt. Ea.	COUPLING COMPLETE † With Grade “E” or “T” Gasket		SPARE PARTS
Nominal Size			Price Each		Plated Bolt & Nut
inches		lb	Painted	Galv.	Size § Inches
2	x 1	2.0	\$188.00	\$226.00	3/8 x 2
	1 1/2	2.0	152.50	184.00	3/8 x 2
2 1/2	x 2	2.9	196.50	245.00	3/8 x 2
	2 1/2	4.6	222.50	281.50	1/2 x 2 3/4
3	x 2	4.6	222.50	281.50	1/2 x 2 3/4
	2 1/2	4.1	194.00	245.00	1/2 x 2 3/4
4	x 2	8.8	351.00	441.00	5/8 x 3 1/4
	2 1/2	8.3	314.50	413.50	5/8 x 3 1/4
	3	6.4	296.00	381.00	5/8 x 3 1/4
5	x 4	10.8	395.50	517.50	3/4 x 4 1/4
6	x 4	16.1	594.50	747.50	3/4 x 4 1/4
	5	12.6	522.50	675.50	3/4 x 4 1/4
8	x 6	22.3	887.00	1121.50	7/8 x 5
10	x 8	32.3	1136.50	1439.00	1 x 6

NOTE: Items listed in shaded areas are non-cancellable and non-returnable.

† Surcharge for couplings supplied without gasket. Contact Victaulic for pricing.

§ Metric thread size bolts available. Contact Victaulic.

NOTE: Support rings required on vertical installations. Please specify on order.

A steel assembly washer is optionally available to prevent pipe from telescoping on vertical installations. No extra charge when specified on order with coupling.

NOTE: See Spare Parts Section for spare part prices.

Couplings, Spare Parts and Fittings

Lubricant



LUBRICANT	Price Each
PACK With 12 Tubes – 4 Fluid Ounces/120 ml Each	\$557.50 ^{NR}
CONTAINER One Quart – 32 Fluid Ounces/960 ml Each	244.00 ^{NR}

^{NR} Non-returnable

To ensure easy assembly and service of all your Victaulic installations including HDPE, be sure to include plenty of Victaulic Lubricant with every order. The following chart provides a rough gauge of quantities recommended, based on the number of units sold.

LUBRICANT USAGE GUIDE								
Size of Gasket inches	Number of Gaskets		Size of Gasket inches	Number of Gaskets		Size of Gasket inches	Number of Gaskets	
	Per Tube	Per Quart		Per Tube	Per Quart		Per Tube	Per Quart
2	140	1120	8	31	252	16	11	86
3	97	773	10	25	202	18	10	76
4	71	558	12	21	171	20	9	69
6	49	383	14	12	98	24	7	57

Gaskets

GASKETS FOR STYLES 07, 75, 77 COUPLINGS

Nom. Size inches	Standard Gaskets		Special Gaskets
	Grade "E" EPDM or Grade "T" Nitrile	Flush-Seal Grade "E" or "T" *	Flush-Seal "L" Silicone *
¾	\$56.50	\$56.50	+
1	56.50 ^{NR}	56.50	\$192.00
1¼	59.50 ^{NR}	59.50	274.50
1½	63.50 ^{NR}	63.50	286.50
2	63.50	63.50 ^{NR}	178.00
2½	74.00	74.00 ^{NR}	206.00
3	78.50	78.50 ^{NR}	222.00
3½	98.00	98.00	+
4	98.00	98.00 ^{NR}	321.50
4½	126.50	-	+
5	126.50 ^{NR}	126.50	628.50
6	135.50	135.50 ^{NR}	688.50 ^{NR}
8	184.50	184.50 ^{NR}	768.50 ^{NR}
10	230.50	230.50 ^{NR}	998.00 ^{NR}
12	268.00	268.00 ^{NR}	1761.00 ^{NR}

NOTE: Items listed in shaded areas are non-cancellable and non-returnable.

^{NR} Non-returnable

+ Quoted on application. Contact Victaulic for pricing and availability.

Couplings, Spare Parts and Fittings

Gaskets

NOTE:

For pricing couplings complete with any special gaskets - take the standard coupling price with Grade "E" or "T" gasket complete (Victaulic Main Price List), subtract the standard gasket price, then add on the price of the special gasket. Gasket guidelines can be found in the latest Victaulic Gasket Selection Guide (publication 05.01). This information is general in scope and Victaulic should be consulted for guidelines when a question arises.

STANDARD "E" OR "T" GASKETS FOR STYLE 750

Nom. Size		Price Each
inches		Grade "E" or "T"
2	x 1	\$59.50
	1½	59.50 ^{NR}
2½	x 2	77.00 ^{NR}
	2½	86.50
3	x 2	86.50
	2½	86.50
	3	104.00 ^{NR}
4	x 2	99.50
	2½	101.50
	3	104.00 ^{NR}
5	x 4	120.50 ^{NR}
6	x 4	136.00
	5	148.00 ^{NR}
8	x 6	164.50 ^{NR}
10	x 8	197.00

NOTE: Items listed in shaded areas are non-cancellable and non-returnable.

^{NR} Non-returnable

Metal Liners

STYLES 77 AND 75 COUPLINGS

(Type 304 Stainless Steel)

STYLES 77 AND 75 COUPLINGS

Nom. Size	Price Each
inches	
2	+
2½	+
3	+
4	+
5	+
6	+
8	+
10	+

Nom. Size	Price Each
inches	
12	+
14	+
16	+
18	+
20	+
24	+

NOTE: Items listed in shaded areas are non-cancellable and non-returnable.

+ Quoted on application. Contact Victaulic for pricing and availability.

Couplings, Spare Parts and Fittings

Plated Trackhead Bolts and Nuts



PLATED TRACKHEAD BOLTS AND NUTS

Bolt and Nut Size inches	Price Each
3/8 x 2	\$29.50 ^{NR}
1/2 x 2 1/2	32.50 ^{NR}
	32.50 ^{NR}
	32.50
	32.50
5/8 x 2 3/4	36.50
	36.50 ^{NR}
	38.00 ^{NR}
	48.00
3/4 x 3 1/4	59.50
	42.50 ^{NR}
	56.00 ^{NR}
	73.50 ^{NR}
7/8 x 5	78.00 ^{NR}
	+

Bolt and Nut Size inches	Price Each
1 x 3 1/2	\$78.50 ^{NR}
	74.00
	90.50 ^{NR}
	90.50 ^{NR}
	95.50 ^{NR}
1 1/8 x 4	121.00 ^{NR}
	121.00 ^{NR}
1 1/4 x 3 1/2	350.00
	350.00
1 3/8 x 5 3/4	405.50
1 1/2 x 4 1/2	386.00
	435.00
1 3/4 x 6	758.50
1 7/8 x 6	1003.50

NOTE: Items listed in shaded areas are non-cancellable and non-returnable.

^{NR} Non-returnable

+ Quoted on application. Contact Victaulic for pricing and availability.

Go-No-Go Tape



Tool Model	Part Number	Purchase Price
PT-100-A Imperial Go/No-Go Grooved Pipe Diameter Tape Each	RW75-100-MCH	\$106.00
Box of 6	RW75-100-KIT	573.50

NOTE: Items listed in shaded areas are non-cancellable and non-returnable.

* Each box contains 6 Go-No-Go Tapes.

Tool discount applies.

GDC-FP



Tool Model	Part Number	Purchase Price
GDC-FP Go/No-Go pocket-sized IGS groove diameter cables for 1" carbon steel pipe	R036-210-MCH	+

NOTE: Items listed in shaded areas are non-cancellable and non-returnable.

+ Quoted on application. Contact Victaulic for pricing and availability.

Couplings, Spare Parts and Fittings

Grooved IPS Pipe Fittings

Elbows

Refer to publication 07.01



No. 12
Gooseneck



No. 12
Standard

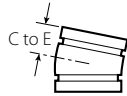

No. 13



ELBOWS – 22½° ELBOW OR 11¼° ELBOW

Nom. Size	22½° Elbow No. 12				11¼° Elbow No. 13			
	Approx. Wgt. Ea. lb	C - E inches	Price Each		Approx. Wgt. Ea. lb	C - E inches	Price Each	
			Painted	Galv.			Painted	Galv.
1	0.6 ‡	3.25	\$841.00	\$868.50	0.3 (sw)	1.38	\$337.00	+
1¼	0.8	1.75	147.50	186.50	0.5	1.38	147.50	\$186.50
1½	0.8	1.75	147.50	186.50	0.5	1.38	147.50	186.50
2	1.4 ‡	3.75	147.50	186.50	1.0	1.38	147.50	186.50
2½	2.3 ‡	4.00	147.50	186.50	1.5	1.50	147.50	186.50
3	3.1 ‡	4.50	211.50	264.00	2.1	1.50	211.50	262.00
3½	4.0 (sw)	2.50	490.00	653.50	2.7 (sw)	1.75	490.00	578.00
4	5.6	2.88	278.00	360.00	3.6	1.75	257.50	341.00
5	7.8 (sw)	2.88	845.00	1018.50	5.0 (sw)	2.00	845.00	993.50
6	12.2 ‡	6.25	774.50	984.50	7.0	2.00	774.50	934.00
8	20.0 ‡	7.75	1608.50	1998.00	10.1	2.00	1375.50	1633.00
10	30.0	4.38	2121.50	2754.50	11.8	2.13	1981.50	2364.00
12	40.0	4.88	2866.00	3554.00	29.3	2.25	2866.00	3470.50

NOTE: Items listed in shaded areas are non-cancellable and non-returnable.

+ Quoted on application. Contact Victaulic for pricing and availability.

(sw) Victaulic fittings are made of ductile iron, except those marked (sw) segmentally welded steel.

‡ Gooseneck design.

Long Radius - 1½ D Elbows

Refer to publication 07.01

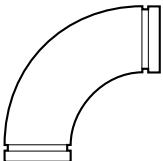

No. 100

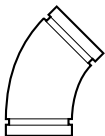

No. 110



LONG RADIUS – 90° LONG RADIUS ELBOW OR 45° LONG RADIUS ELBOW

Nom. Size	90° Long Rad. Elbow No. 100 *				45° Long Rad. Elbow No. 110 *			
	Approx. Wgt. Ea. lb	C - E inches	Price Each		Approx. Wgt. Ea. lb	C - E inches	Price Each	
			Painted	Galv.			Painted	Galv.
2	2.5	4.38	\$304.00	\$398.50	1.8	2.75	\$264.00	\$333.50
2½	3.4	5.13	380.50	435.50	2.8	3.00	838.00	942.50
3	6.0	5.88	304.00	398.50	4.9	3.38	264.00	333.50
4	12.3	7.50	450.50	602.00	7.3	4.00	320.50	425.00
5	18.0	9.25	2275.00	2608.00	14.8 (sw)	4.88	2114.00	2320.50
6	30.4	10.75	1303.50	1711.00	17.4	5.50	935.00	1198.50
8	66.0	14.25	3112.00	3977.00	36.0	7.25	1625.00	2112.00
10	107.0	15.00	3577.50	4472.50	57.0	6.25	2193.00	2741.50
12	156.0	18.00	3937.00	4920.00	90.0	7.50	2962.00	3702.00

NOTE: Items listed in shaded areas are non-cancellable and non-returnable.

(sw) Victaulic fittings are made of ductile iron, except those marked (sw) segmentally welded steel.

Couplings, Spare Parts and Fittings

Tee

Refer to publication 07.01

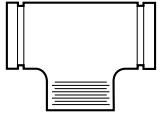

No. 29M



TEE WITH THREADED BRANCH

Nom. Size	Approx. Wgt. Ea.	Tee with Male Threaded Branch No. 29M	
		Price Each	
inches	lb	Painted	Galv.
3/4	0.6	\$531.00	\$595.50
1	1.0	434.50	509.50
1 1/4	1.5	434.50	509.50
1 1/2	2.0	675.50	795.00
2	3.0	434.50	509.50
3 1/2	7.9 (sw)	+	+
4	11.3	894.50	1229.00
5	17.8	2565.00	+
6	25.7	2290.50	2695.50
8	47.6	+	+
10	99.0	+	+
12	133.0	+	+

NOTE: Items listed in shaded areas are non-cancellable and non-returnable.

+ Quoted on application. Contact Victaulic for pricing and availability.

(sw) Victaulic fittings are made of ductile iron, except those marked (sw) segmentally welded steel.

Cross and Wye

Refer to publication 07.01

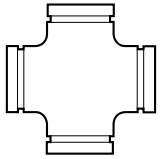

No. 35

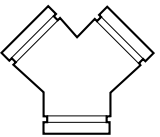

No. 33

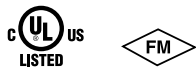

CROSS AND WYE – STEEL CROSS OR STEEL 90 TRUE Y

Nom. Size	Approx. Wgt. Ea.	Steel Cross No. 35		Steel 90 True Wye No. 33		
		Price Each		Approx. Wgt. Ea. lb	Price Each	
inches	lb	Painted	Galv.		Painted	Galv.
3/4	0.9	+	+	0.7	+	+
1	1.3	\$500.00	\$576.00	1.1	\$764.00	+
1 1/4	2.1	599.50	698.50	1.5	764.00	+
1 1/2	2.5	646.50	749.00	1.8	764.00	\$908.50
2	3.8	369.50	440.50	2.5	764.00	908.50
2 1/2	6.1	369.50	440.50	4.3	764.00	908.50
3	10.5	656.50	802.00	6.1	912.00	1084.00
3 1/2	11.5	1316.00	1568.50	9.6		
4	15.8	1085.50	1336.00	9.8	1195.00	1435.00
4 1/2	18.5	+	+	-	-	-
5	20.0	2212.00	2664.50	15.0	1708.00	2050.50
6	28.0	2836.50	3443.50	22.3	2107.50	2567.00
8	48.0	3736.00	4622.50	36.0	3034.00	3727.50
10	121.5	6128.00	7581.00	69.9	5037.00	6169.50
12	110.0	8843.50	11016.00	80.0	5563.00	7035.00

NOTE: Items listed in shaded areas are non-cancellable and non-returnable.

+ Quoted on application. Contact Victaulic for pricing and availability.

Couplings, Spare Parts and Fittings

Adapter Nipples ‡

Same prices apply for:
 No. 40
 Grooved x Threaded
 No. 42
 Grooved x Beveled
 No. 43
 Grooved x Grooved
 Refer to publication 07.01



No. 40



No. 42



No. 43

ADAPTER NIPPLES – GROOVED X THREADED, GROOVED X BEVELED, OR GROOVED X GROOVED

Nom. Size inches	Price Per Length – inches					
	3	4	6	8	10	12
¾	\$83.00	\$83.00	+	+	+	+
1	83.00	83.00	\$129.50	+	+	+
1¼	83.00	83.00	129.50	+	+	+
1½	83.00	83.00	129.50	\$149.00	\$171.00	\$195.50
2	83.00	83.00	129.50	149.00	171.00	195.50
2½	95.50	95.50	172.00	172.00	201.00	228.00
3	116.00	116.00	185.50	222.00	259.50	294.50
4	187.50	187.50*	187.50	306.00	360.00	413.50
5	383.00*	383.00*	383.00	532.50	656.50	755.00
6	490.50	490.50*	490.50*	633.00	735.50	835.00
8	549.50*	549.50*	549.50*	729.50	1001.50	1123.00
10	709.00*	709.00*	714.00*	768.50	1183.00	1407.50
12	962.50*	962.50*	908.00*	962.50	1497.50	1783.00

Special lengths not shown, heavier wall thickness, electroplated and galvanized nipples are priced on application.
 GALVANIZED AND EXTRA HEAVY ARE NON-CANCELLABLE AND NON-RETURNABLE ITEMS.

‡ Contact Victaulic for pricing on seamless adapter nipples.

NOTE: Items listed in shaded areas are special order, non-cancellable and non-returnable items.

Unless otherwise specified, Adapter Nipples for nominal pipe sizes 6" and smaller are made from Schedule 40 pipe; for nominal sizes 8" and larger, from Schedule 30 pipe.

NOTE: For Pump Package Nipples with 1 ½" hole cut to receive Style 923 Strapless Outlet or Style 924 Thermometer Outlet add **\$192.50** to No. 40, 42 or 43 Nipple prices and request No. 40-H, 42-H or 43-H on order. No. 40-H, 42-H and 43-H are non-cancellable and non-returnable.

*** These sizes available only in No. 42 grooved x beveled and No. 43 grooved x grooved.**

+ Quoted on application. Contact Victaulic for pricing and availability.

Female Threaded Adapter

Refer to publication 07.01



No. 80

FEMALE THREADED ADAPTER

Nom. Size inches	Approx. Wgt. Each lb	No. 80 Price Each	
		Painted	Galv.
¾	1.0	\$688.50	\$761.50
1	1.0	737.50	791.00
1¼	1.5 (sw)	391.00	437.50
1½	1.5 (sw)	505.00	538.50
2	1.4	241.00	281.50
2½	1.5	241.00	281.50
3	2.9	278.00	339.50
4	4.5	424.00	531.50

NOTE: Items listed in shaded areas are non-cancellable and non-returnable.

Available with British Standard Pipe Threads (BSPT). Contact Victaulic for details.

(sw) Victaulic fittings are made of ductile iron, except those marked (sw) segmentally welded steel.

Couplings, Spare Parts and Fittings

Adapter Elbows

Refer to publication 07.01

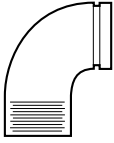

No. 18



No. 19



ADAPTER ELBOWS – 90° ADAPTER ELBOW OR 45° ADAPTER ELBOW

Nom. Size inches	90° Adapter Elbow No. 18			45° Adapter Elbow No. 19		
	Approx. Wgt. Ea. lb	Price Each		Approx. Wgt. Ea. lb	Price Each	
		Painted	Galv.		Painted	Galv.
¾	0.5	\$344.50	\$366.00	0.5	\$351.00	\$372.00
1	0.5	232.00	286.50	0.6	–	–
1¼	0.9	259.50	286.50	0.6	–	–
1½	1.1	329.50	382.00	0.9	380.50	405.00
2	2.5	232.00	286.50	1.9	–	–
2½	3.0	400.50	437.50	2.3	391.00	403.00
3	5.8	372.00	454.50	5.0	664.00	713.00
6	17.6	1143.50	1445.00	12.7	1390.50	1545.00

NOTE: Items listed in shaded areas are non-cancellable and non-returnable.

Available with British Standard Pipe Threads (BSPT). Contact Victaulic for details.

Couplings, Spare Parts and Fittings

Reducing Tee

Refer to publication 07.01

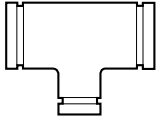

No. 25



REDUCING TEE

Size				Approx. Wgt. Each lb	Reducing Tee No. 25		
inches					Painted	Galv.	
Run x Branch							
1	x	1	x	¾ (sw)	1.0	\$353.00	\$414.50
1¼	x	1¼	x	1 (sw)	1.3	365.50	414.50
1½	x	1½	x	¾ (sw)	1.5	369.50	508.00
				1 (sw)	1.5	508.00	523.00
				1¼ (sw)	1.7	385.00	426.00
2	x	2	x	¾	2.5	479.00	563.00
				1	2.7	437.50	511.50
				1¼ (sw)	1.8	545.00	572.50
				1½	3.0	437.50	519.50
2½	x	2½	x	¾ (sw)	3.9	588.50	638.00
				1	3.8	437.50	511.50
				1¼	4.2	658.00	774.50
				1½	3.9	437.50	519.50
				2	4.5	437.50	519.50
3	x	3	x	¾ (sw)	5.7	678.00	706.50
				1	6.1	386.00	492.00
				1¼	8.0	541.00	714.50
				1½	6.5	386.00	497.50
				2	6.2	386.00	497.50
				2½	6.6	386.00	497.50
4	x	4	x	¾ (sw)	8.0	867.00	925.00
				1	7.8	519.50	648.00
				1¼ (sw)	9.6	1018.50	1186.50
				1½	10.2	519.50	648.00
				2	11.2	519.50	679.50
				2½	11.4	519.50	679.50
5	x	5	x	1 (sw)	14.0	1141.50	1403.00
				1½ (sw)	14.3	1448.50	1568.50
				2 (sw)	14.5	1255.00	1550.00
				2½	15.2	1023.00	1287.00
				3	16.6	1023.00	1287.00
				4	16.7	1106.50	1398.50
6	x	6	x	1 (sw)	23.0	1375.50	1686.00
				1½ (sw)	24.0	1421.00	1945.00
				2	21.6	1218.50	1599.50
				2½	21.4	1218.50	1599.50
				3	26.5	1218.50	1599.50
				4	25.0	1218.50	1599.50
8	x	8	x	1½ (sw)	33.0	1755.00	2134.50
				2 (sw)	33.5	1755.00	2214.50
				2½ (sw)	39.0	1755.00	2214.50
				3	33.6	1890.00	2257.00

NOTE: Items listed in shaded areas are non-cancellable and non-returnable.

(sw) Victaulic fittings are made of ductile iron, except those marked (sw) segmentally welded steel.

Couplings, Spare Parts and Fittings

Size				Reducing Tee No. 25			
inches				Approx. Wgt. Each lb	Price Each		
Run x Branch					Painted	Galv.	
8	x	8	x	4	41.8	\$2534.50	\$3274.50
				5 (sw)	34.0	2534.50	3297.00
				6	42.3	2534.50	3310.50
10	x	10	x	1½ (sw)	62.0	2539.50	3327.00
				2 (sw)	62.0	2580.50	3327.00
				2½ (sw)	62.4	2621.00	3327.00
				3 (sw)	60.0	2661.50	3354.00
				4	61.0	2702.50	3378.00
				5 (sw)	52.0	2743.00	3429.00
				6	59.0	2783.50	3479.50
				8	64.7	2823.50	3530.00
12	x	12	x	1 (sw)	77.0	2828.50	3541.50
				2 (sw)	80.0	2856.00	3552.00
				2½ (sw)	78.0	2885.50	3562.50
				3 (sw)	82.0	2914.00	3574.50
				4 (sw)	80.0	2944.00	3585.00
				5 (sw)	75.0	2973.00	3596.50
				6 (sw)	75.0	3002.00	3607.00
				8 (sw)	80.0	3350.00	4024.50
				10 (sw)	84.0	3537.50	4274.50

NOTE: Items listed in shaded areas are non-cancellable and non-returnable.

(sw) Victaulic fittings are made of ductile iron, except those marked (sw) segmentally welded steel.

Couplings, Spare Parts and Fittings

Reducing Tee with Threaded Branch

Refer to publication 07.01

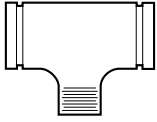

No. 29T



REDUCING TEE WITH THREADED BRANCH

Size					Reducing Tee No. 29T with Threaded Branch		
inches					Approx. Wgt. Each lb	Price Each	
Run x Branch						Painted	Galv.
1	x	1	x	3/4	1.0 (sw)	+	+
1 1/4	x	1 1/4	x	1	1.3 (sw)	+	+
1 1/2	x	1 1/2	x	3/4	1.5 (sw)	+	+
				1	1.5 (sw)	+	+
				1 1/4	1.7 (sw)	+	+
2	x	2	x	3/4	2.5	\$506.00	\$594.50
				1	2.7	462.50	541.00
				1 1/4	2.9 (sw)	775.00	828.00
				1 1/2	3.0	462.50	548.50
2 1/2	x	2 1/2	x	3/4	3.5 (sw)	905.00	933.00
				1	3.8	462.50	541.00
				1 1/4	3.8	1005.00	1032.50
				1 1/2	3.9	462.50	548.50
				2	4.5	462.50	553.00
3	x	3	x	3/4	5.9 (sw)	844.00	896.00
				1	6.1	462.50	577.00
				1 1/4	6.3	1134.00	1205.50
				1 1/2	6.5	462.50	579.50
				2	6.2	462.50	579.50
				2 1/2	6.4	1107.50	1199.00
4	x	4	x	3/4	7.2 (sw)	1223.50	1507.00
				1	7.8	577.00	709.00
				1 1/4	8.5 (sw)	1181.50	1273.00
				1 1/2	9.2	577.00	721.00
				2	11.2	577.00	721.00
				2 1/2	11.4	577.00	742.00
				3	11.6	577.00	745.00
5	x	5	x	2	14.5 (sw)	1229.50	1340.00
				2 1/2	15.2	1105.50	1399.50
				3	16.6 (sw)	1023.00	1287.00
				4	16.7 (sw)	1105.50	1507.00
6	x	6	x	1	23.0 (sw)	1675.50	1947.50
				1 1/2	25.0 (sw)	1483.00	1866.00
				2	21.6	1434.50	1785.50
				2 1/2	21.4	1434.50	1785.50
				3	26.5	1434.50	1785.50
				4	25.0 (sw)	1811.50	1947.50
				5	23.2 (sw)	1434.50	1785.50
8	x	8	x	2	33.5 (sw)	1755.00	2419.00
				3	33.6 (sw)	2419.00	3136.50
				4	41.8 (sw)	2534.50	3274.50
				5	34.0 (sw)	2534.50	3294.00
				6	42.3 (sw)	2804.00	3850.00

NOTE: Items listed in shaded areas are non-cancellable and non-returnable.

Available with British Standard Pipe Threads (BSPT). Contact Victaulic for details.

(sw) Victaulic fittings are made of ductile iron, except those marked (sw) segmentally welded steel.

+ Quoted on application. Contact Victaulic for pricing and availability.

Couplings, Spare Parts and Fittings

Reducing Tee with Threaded Branch

Refer to publication 07.01

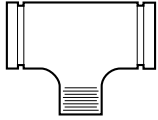

No. 29T



REDUCING TEE WITH THREADED BRANCH

Size				Reducing Tee No. 29T with Threaded Branch (sw)			
inches				Approx. Wgt. Each lb	Price Each		
Run x Branch					Painted	Galv.	
10	x	10	x	2	62.0	\$2938.00	\$4291.50
				3	60.0	2938.00	3644.50
				4	61.0	3074.00	3928.00
				5	52.0	2702.50	4010.00
				6	59.0	3141.50	4062.50
				8	64.7	4235.00	4734.50
12	x	12	x	3	80.0	3956.00	5107.50
				4	82.0	4239.00	5444.00
				5	75.0	4481.00	5819.50
				6	75.0	4535.50	5874.00
				8	80.0	4662.50	6010.50
				10	84.0	4880.00	6020.00

NOTE: Items listed in shaded areas are non-cancellable and non-returnable.

Available with British Standard Pipe Threads (BSPT). Contact Victaulic for details.

(sw) Victaulic fittings are made of ductile iron, except those marked (sw) segmentally welded steel.

Couplings, Spare Parts and Fittings

Reducers

Refer to publication 07.01



No. 50

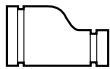

No. 51



REDUCERS – CONCENTRIC OR ECCENTRIC *

Size		Concentric Reducer No. 50			Eccentric Reducer No. 51		
		Approx. Wgt. Ea. lb	Price Each		Approx. Wgt. Ea. lb	Price Each	
inches	Painted		Galv.	Painted		Galv.	
1¼	x ¾	1.9	\$599.50	\$658.00	3.2	+	+
	1	1.9	628.00	690.00	3.2	+	+
1½	x ¾	1.4	706.00	762.00	4.5	+	+
	1	0.8	158.00	185.50	4.5 (sw)	\$612.00	\$775.00
	1¼	1.0	158.00	185.50	4.5	647.50	809.00
2	x ¾	0.9	158.00	185.50	2.0 (sw)	729.50	+
	1	0.7	158.00	185.50	2.3 (sw)	729.50	818.00
	1¼	1.2	172.00	202.00	4.6 (sw)	797.00	+
	1½	1.0	158.00	185.50	1.1	164.50	195.00
2½	x ¾	1.3	1227.00	1324.00	3.3	1842.50	2075.50
	1	1.1	214.00	245.50	3.5	1716.00	1899.00
	1¼	3.3	158.00	185.50	1.4	176.00	202.50
	1½	3.6	158.00	185.50	3.7 (sw)	796.00	908.50
	2	3.9	158.00	185.50	4.3	326.50	442.50
3	x ¾	1.5	1234.00	1380.00	4.5	+	+
	1	1.3	172.00	209.50	4.8 (sw)	1840.50	2026.00
	1¼	1.4	274.50	315.00	4.8	1667.00	+
	1½	5.1	190.00	230.50	5.1 (sw)	918.00	1072.00
	2	1.6	140.00	170.50	6.0	373.00	508.00
	2½	1.8	190.00	228.50	7.0	373.00	519.50
3½	x 3	2.0	201.50	243.00	7.0 (sw)	2021.50	+
4	x 1	3.0	208.50	255.00	6.5 (sw)	3724.00	+
	1¼	4.6	1577.00	1768.00	-	-	-
	1½	2.6 (sw)	286.50	378.00	8.1 (sw)	2254.00	2434.00
	2	2.4	185.50	227.00	3.3	453.50	632.00
	2½	2.7	228.50	277.50	3.4	453.50	632.00
	3	3.2	228.50	277.50	3.5	453.50	632.00
	3½	2.9	228.50	277.50	8.0 (sw)	3152.50	+

NOTE: Items listed in shaded areas are non-cancellable and non-returnable.

+ Quoted on application. Contact Victaulic for pricing and availability.

(sw) Victaulic fittings are made of ductile iron, except those marked (sw) segmentally welded steel.

Couplings, Spare Parts and Fittings

Size			Concentric Reducer No. 50			Eccentric Reducer No. 51		
inches	x	inches	Approx. Wgt. Ea. lb	Price Each		Approx. Wgt. Ea. lb	Price Each	
				Painted	Galv.		Painted	Galv.
5	x	2	9.0 (sw)	\$2217.00	\$2449.50	5.2 (sw)	\$2486.00	+
		2½	4.3	462.50	562.50	10.8 (sw)	2117.50	+
		3	5.0	264.00	326.50	11.1 (sw)	2047.50	\$2281.50
		4	4.3	314.00	392.00	12.0	614.50	867.00
6	x	1	5.0	414.50	517.00	14.5 (sw)	\$3856.00	4188.00
		1½	5.5	+	+	+	3738.50	+
		2	6.6	414.50	517.00	14.5 (sw)	3519.50	3831.50
		2½	6.4	462.50	566.50	14.2 (sw)	4188.00	4559.00
		3	6.4	414.50	517.00	15.0	815.50	1143.50
		4	6.5	364.50	469.00	17.0	715.00	1048.50
		5	6.4	535.00	662.50	17.0	857.50	1213.50
8	x	3	9.3	737.50	918.00	22.0 (sw)	4085.50	4449.50
		4	10.4	737.50	923.00	23.0 (sw)	3574.00	4076.00
		5	11.6	737.50	927.50	23.0 (sw)	3574.00	4076.00
		6	11.9	934.50	1170.50	24.0	1440.50	1959.00
10	x	4	19.7	1675.00	2063.00	32.0 (sw)	6307.00	7563.00
		5	33.0	3683.50	4202.50	34.6	5940.50	6990.50
		6	20.0	1833.50	2284.00	36.9 (sw)	4481.00	5311.50
		8	22.0	1833.50	2322.50	21.6	3795.00	4717.00
12	x	4	44.0	8013.00	9536.00	48.0 (sw)	6624.00	7792.00
		6	24.6	2185.50	2699.50	50.0 (sw)	5984.50	7207.50
		8	52.0	3275.50	3867.50	53.5 (sw)	5833.50	6979.00
		10	39.0	3275.50	4054.50	57.0 (sw)	5223.00	6193.50

NOTE: Items listed in shaded areas are non-cancellable and non-returnable.

+ Quoted on application. Contact Victaulic for pricing and availability.

(sw) Victaulic fittings are made of ductile iron, except those marked (sw) segmentally welded steel.

Couplings, Spare Parts and Fittings

Reducer - Male Threaded Small End

Refer to publication 07.01



No. 52



REDUCER - MALE THREADED SMALL END

Nominal Size	Approx. Wgt. Ea.	Price Each			
		Painted	Galv.		
1½ inches Inlet x Outlet	lb	1	0.8	\$164.50	\$201.50
		1¼	0.9	172.00	202.00
2 x	lb	¾	0.9	164.50	201.50
		1	0.7	164.50	201.50
		1¼	1.2	164.50	201.50
		1½	1.0	164.50	201.50
2½ x	lb	1	1.1	221.50	254.00
		1¼	1.2	232.00	284.50
		1½	1.3	243.00	284.50
		2	1.4	164.50	201.50
3 x	lb	¾	1.5 (sw)	1162.50	1236.50
		1	1.3	178.50	215.00
		1½	1.5	201.50	241.00
		2	1.5	201.50	241.00
		2½	2.4	243.00	284.50
4 x	lb	1	2.3	229.50	277.50
		1½	2.7	533.00	696.50
		2	2.6	244.00	291.50
		2½	2.6	245.00	300.00
		3	2.5	299.50	352.50
5 x	4	4.5	1682.00	1829.50	
6 x	lb	1	5.5	462.50	566.50
		2	5.7	462.50	566.50
		2½	5.8	462.50	566.50
		3	5.8	462.50	566.50
		4	6.5 (sw)	2760.50	3057.00
		5	2.0 (sw)	4308.50	+

NOTE: Items listed in shaded areas are non-cancellable and non-returnable.

+ Quoted on application. Contact Victaulic for pricing and availability.

Available with British Standard Pipe Threads (BSPT). Contact Victaulic for details.

(sw) Victaulic fittings are made of ductile iron, except those marked (sw) segmentally welded steel.

VicFlex™ Flexible Sprinkler Fitting Systems



VicFlex™ Sprinkler Fitting Systems

Series AH2-CC Hose

Refer to publication 10.85



Braided AH2-CC Hose



Size		Approx. Wgt. Ea. lb	Painted Coupling		Galv. Coupling		Sold in Box Quantities of
inches			Part No.	Price Each	Part No.	Price Each	
31	x 1/2	3.3	A31HAQBP2C	\$121.00 ^{NR}	A31HAQBG2C	\$135.00	10
	3/4	3.3	A31TAQBP2C	121.00 ^{NR}	A31TAQBG2C	135.00	10
36	x 1/2	3.6	A36HAQBP2C	127.00 ^{NR}	A36HAQBG2C	140.00	10
	3/4	3.6	A36TAQBP2C	127.00 ^{NR}	A36TAQBG2C	140.00	10
48	x 1/2	4.3	A48HAQBP2C	132.00 ^{NR}	A48HAQBG2C	146.00	10
	3/4	4.3	A48TAQBP2C	132.00 ^{NR}	A48TAQBG2C	146.00	10
60	x 1/2	5.0	A60HAQBP2C	146.50 ^{NR}	A60HAQBG2C	160.00	10
	3/4	5.0	A60TAQBP2C	146.50 ^{NR}	A60TAQBG2C	160.00	10
72	x 1/2	5.7	A72HAQBP2C	160.00 ^{NR}	A72HAQBG2C	173.00	10
	3/4	5.7	A72TAQBP2C	160.00 ^{NR}	A72TAQBG2C	173.00	10

NOTE: Items listed in shaded areas are non-cancellable and non-returnable.

^{NR} Non-returnable

Series AH2-CC-300 Hose

UL Listed and FM Approved up to
300 psi

Refer to publication 10.84



Braided AH2-300-CC Hose



Size		Approx. Wgt. Ea. lb	Victaulic	Price Each	Sold in Box Quantities of
inches			Part No.		
31	x 1/2	2.8	A31HAQB30C	\$147.50	10
	3/4	2.8	A31TAQB30C	147.50	10
36	x 1/2	3.1	A36HAQB30C	154.00	10
	3/4	3.1	A36TAQB30C	154.00	10
48	x 1/2	3.8	A48HAQB30C	159.00	10
	3/4	3.8	A48TAQB30C	159.00	10
60	x 1/2	4.5	A60HAQB30C	175.00	10
	3/4	4.5	A60TAQB30C	175.00	10
72	x 1/2	5.2	A72HAQB30C	189.50	10
	3/4	5.2	A72TAQB30C	189.50	10

NOTE: Items listed in shaded areas are non-cancellable and non-returnable.

VicFlex™ Sprinkler Fitting Systems

Series AH2 Hose

Refer to publication 10.85



Braided AH2 Hose



Size		Approx. Wgt. Ea.	Victaulic		Price Each	Sold in Box Quantities of
inches			Part No.			
31	x 1/2	2.8	A31HAQFBA2	\$109.50 ^{NR}	10	
	x 3/4		A31TAQFBA2	109.50 ^{NR}		
36	x 1/2	3.1	A36HAQFBA2	116.00 ^{NR}	10	
	x 3/4		A36TAQFBA2	116.00 ^{NR}		
48	x 1/2	3.8	A48HAQFBA2	121.50 ^{NR}	10	
	x 3/4		A48TAQFBA2	121.50 ^{NR}		
60	x 1/2	4.5	A60HAQFBA2	137.00 ^{NR}	10	
	x 3/4		A60TAQFBA2	137.00 ^{NR}		
72	x 1/2	5.2	A72HAQFBA2	149.50 ^{NR}	10	
	x 3/4		A72TAQFBA2	149.50 ^{NR}		

^{NR} Non-returnable

Series AH2-300 Hose

FM Approved up to 300 psi
Refer to publication 10.84



Braided AH2-300 Hose



Size		Approx. Wgt. Ea.	Victaulic		Price Each	Sold in Box Quantities of
inches			Part No.			
31	x 1/2	2.8	A31HAQB300	\$120.50	10	
	x 3/4		A31TAQB300	120.50		
36	x 1/2	3.1	A36HAQB300	126.50	10	
	x 3/4		A36TAQB300	126.50		
48	x 1/2	3.8	A48HAQB300	131.50 ^{NR}	10	
	x 3/4		A48TAQB300	131.50		
60	x 1/2	4.5	A60HAQB300	147.00 ^{NR}	10	
	x 3/4		A60TAQB300	147.00		
72	x 1/2	5.2	A72HAQB300	161.00	10	
	x 3/4		A72TAQB300	161.00		

NOTE: Items listed in shaded areas are non-cancellable and non-returnable.

^{NR} Non-returnable

Series AH1-CC Hose

Refer to publication 10.95



Braided AH1-CC Hose



Size		Approx. Wgt. Ea.	Painted Coupling		Galv. Coupling		Sold in Box Quantities of
inches			lb	Victaulic Part No.	Price Each	Victaulic Part No.	
31	x 1/2	2.9	A31HAQBP1C	\$94.00 ^{NR}	A31HAQBG1C	\$108.00	10
	x 3/4		A31TAQBP1C	94.00 ^{NR}	A31TAQBG1C	108.00	
36	x 1/2	3.1	A36HAQBP1C	100.00 ^{NR}	A36HAQBG1C	113.00	10
	x 3/4		A36TAQBP1C	100.00 ^{NR}	A36TAQBG1C	113.00	
48	x 1/2	3.6	A48HAQBP1C	106.00 ^{NR}	A48HAQBG1C	119.50	10
	x 3/4		A48TAQBP1C	106.00 ^{NR}	A48TAQBG1C	119.50	
60	x 1/2	4.1	A60HAQBP1C	119.50 ^{NR}	A60HAQBG1C	132.00	10
	x 3/4		A60TAQBP1C	119.50 ^{NR}	A60TAQBG1C	132.00	
72	x 1/2	4.6	A72HAQBP1C	132.00 ^{NR}	A72HAQBG1C	146.50	10
	x 3/4		A72TAQBP1C	132.00 ^{NR}	A72TAQBG1C	146.50	

NOTE: Items listed in shaded areas are non-cancellable and non-returnable.

^{NR} Non-returnable

VicFlex™ Sprinkler Fitting Systems

Series AH1 Hose

Refer to publication 10.95



Braided AH1 Hose



Size		Approx. Wgt. Ea.	Victaulic Part No.	Price Each	Sold in Box Quantities of
inches					
31	x 1/2	2.4	A31HAQBBA1	\$81.50 ^{NR}	10
	x 3/4	2.4	A31TAQBBA1	81.50 ^{NR}	10
36	x 1/2	2.6	A36HAQBBA1	87.00 ^{NR}	10
	x 3/4	2.6	A36TAQBBA1	87.00 ^{NR}	10
48	x 1/2	3.1	A48HAQBBA1	93.50 ^{NR}	10
	x 3/4	3.1	A48TAQBBA1	93.50 ^{NR}	10
60	x 1/2	3.6	A60HAQBBA1	108.00 ^{NR}	10
	x 3/4	3.6	A60TAQBBA1	108.00 ^{NR}	10
72	x 1/2	4.1	A72HAQBBA1	121.50 ^{NR}	10
	x 3/4	4.1	A72TAQBBA1	121.50 ^{NR}	10

^{NR} Non-returnable

VicFlex™ Sprinkler Fitting Systems

VicFlex™ Brackets

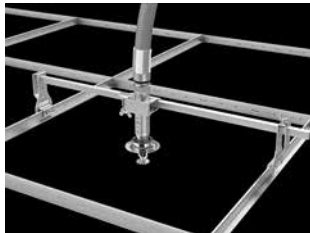

Style AB2 Bracket

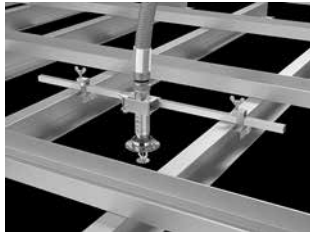

Style AB5 Bracket

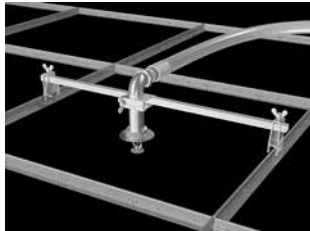

Style AB11 Bracket



Style AB12 Bracket



Style ABBA Bracket



Style ABMM Bracket

Brackets Description	Size inches	Approx. Wgt. Ea. lb	Victaulic Part No.	Price Each	Sold in Box Quantities of
Style AB2 For suspended and hard-lid ceilings – Over/ Under Center Bracket allows for installation and vertical adjustment from above or below the ceiling surface (Includes all previous Style AB1 features)	24	1.8	A240AB200N	\$29.00 ^{NR}	10
	48	2.7	A480AB200N	37.50 ^{NR}	10
Style AB3 Surface mount applications, wood, metal and block walls	–	0.3	A000AQFINB	13.00 ^{NR}	10
Style AB4 For hard-lid ceilings with hat furring channel grid systems – Over/Under Center Bracket allows for installation and vertical adjustment from above or below the ceiling surface	24	1.5	A240AB400N	37.50 ^{NR}	10
	48	2.2	A480AB400N	48.00 ^{NR}	10
Style AB5 For hard-lid ceilings - Over/Under Center Bracket allows for installation and vertical adjustment from above or below the ceiling surface	24	1.6	A240AB500N	29.00 ^{NR}	10
	48	2.3	A480AB500N	37.50 ^{NR}	10
Style AB7 For suspended ceilings	24	1.4	A000AQFBEE	19.00 ^{NR}	10
	48	1.9	A000AQFB48	29.00 ^{NR}	10
Style AB7 Adjustable For suspended ceilings	24	1.5	A275AQFADJ	19.50 ^{NR}	10
	48	2.0	A551AQFADJ	28.50 ^{NR}	10
Style AB10 For Armstrong® Techzone™ Ceilings	6	1.1	A06AB100TZ	38.00 ^{NR}	10
Style AB11 For lay-in panel suspended t-grid ceilings or drywall suspended t-grid ceilings, allows for low profile installations	24	1.5	A240B11000	29.00 ^{NR}	10
	48	2.7	A480B11000	37.50 ^{NR}	10
Style AB12 For suspended and hard-lid ceilings, allows for vertical sprinkler adjustment, and allows for low profile installation down to 4" 100 mm	–	0.4	A040AQBB12	13.50 ^{NR}	10
Style ABBA For suspended, exposed and hard-lid ceilings, allows for above mount and cantilever mount.	–	1.3	A000AQBBAM	29.00 ^{NR}	10
Style ABMM For wood, metal, block walls or ceilings, and hard-lid ceilings, allows surface mount and stand-off mount.	–	0.7	A000AQBBK1	17.00 ^{NR}	10

^{NR} Non-returnable

VicFlex™ Sprinkler Fitting Systems

VicFlex™ Reducers and End Fittings



End Fittings and Parts	Outlet Size	Approx. Wgt. Ea.	Victaulic	Price	Sold in Box
Description	inches	lb	Part No.	Each	Quantities of
Reducing Nipple – 5¾"/140 mm Length	½	0.7	A004AQB RNH	\$23.00 ^{NR}	10
	¾	0.7	A006AQB RNT	23.00 ^{NR}	10
Reducing Nipple – 9"/229 mm Length	½	1.6	A090AQFRNH	32.00 ^{NR}	10
	¾	1.7	A090AQFRNT	32.00 ^{NR}	10
Reducing Nipple – 13"/330 mm Length	½	2.3	A130AQFRNH	42.00 ^{NR}	10
	¾	2.3	A130AQFRNT	42.00 ^{NR}	10
90° Reducing Elbow – 4"/102 mm Length	½	1.0	A000AQFRE4	40.00 ^{NR}	10
	¾	1.0	A000AQFRE6	40.00 ^{NR}	10
90° Reducing Elbow – 6"/152 mm Length	½	1.2	A000AQFRE5	40.00 ^{NR}	10
	¾	1.2	A000AQFRE7	40.00 ^{NR}	10
Low Profile Long 90° Reducing Elbow – Recessed Sprinkler *	½	1.0	A004AQBDE1	40.00 ^{NR}	10
	¾	1.0	A006AQBDE1	40.00 ^{NR}	10
Low Profile Short 90° Reducing Elbow – Concealed Sprinkler *	½	0.7	A004AQBDEL	40.00 ^{NR}	10
	¾	0.7	A006AQBDEL	40.00 ^{NR}	10

^{NR} Non-returnable

VicFlex™ Sprinkler Fitting Systems

VicFlex™ Preassembled System Order Form

Order No.	Date
Company Name	
Address	
State	Zip Code
Tag	

Ship To:

Company Name	Zip Code/Postal Code
Address	
State/Province	Email
Phone No.	
Fax No.	

Bill To:

		Sprinkler Selection					Hose/Bracket Selection						
<input type="checkbox"/> A - VicFlex	<input type="checkbox"/> 27 - V27 <input type="checkbox"/> 31 - V31 <input type="checkbox"/> 34 - V34 <input type="checkbox"/> 38 - V38 <input type="checkbox"/> 42 - V42 <input type="checkbox"/> 56 - V56 <input type="checkbox"/> 11 - V11	<input type="checkbox"/> 1 - 1/2" NPT <input type="checkbox"/> 2 - 3/4" NPT	<input type="checkbox"/> B - STD PEND <input type="checkbox"/> G - ECH/PEND <input type="checkbox"/> J - ECH CNC <input type="checkbox"/> K - RES PEND <input type="checkbox"/> N - RES CNC <input type="checkbox"/> C - HSW <input type="checkbox"/> P - CNCL PEN <input type="checkbox"/> F - ECH PEN	<input type="checkbox"/> A - 135°F/57°C <input type="checkbox"/> C - 155°F/68°C <input type="checkbox"/> E - 175°F/79°C <input type="checkbox"/> F - 200°F/93°C	<input type="checkbox"/> S - Standard <input type="checkbox"/> Q - Quick	<input type="checkbox"/> H - 4.9 <input type="checkbox"/> 4 - 5.6 <input type="checkbox"/> 5 - 8.0 <input type="checkbox"/> 6 - 11.2 <input type="checkbox"/> 7 - 14.0 <input type="checkbox"/> A - 4.2	<input type="checkbox"/> 1 - Plain Brass <input type="checkbox"/> 2 - Chrome <input type="checkbox"/> 4 - White (RAL 9010) <input type="checkbox"/> W - Bright White (RAL 9003) <input type="checkbox"/> N - VZ50 ¹	<input type="checkbox"/> W - White SS Escutcheon <input type="checkbox"/> X - Stainless Escutcheon <input type="checkbox"/> 0 - Match to Sprinkler Finish	<input type="checkbox"/> 1 - 5 1/4" Straight <input type="checkbox"/> 2 - 9" Straight <input type="checkbox"/> 3 - 13" Straight <input type="checkbox"/> 4 - 4 1/4" Elbow <input type="checkbox"/> 5 - 6 1/4" Elbow <input type="checkbox"/> 6 - Short Low Profile 90° Elbow <input type="checkbox"/> 7 - Long Low Profile 90° Elbow	<input type="checkbox"/> 2 - 31" <input type="checkbox"/> 3 - 36" <input type="checkbox"/> 4 - 48" <input type="checkbox"/> 5 - 60" <input type="checkbox"/> 6 - 72"	<input type="checkbox"/> 1 - AH1 <input type="checkbox"/> 2 - AH2 <input type="checkbox"/> 6 - AH2-300 <input type="checkbox"/> 7 - AH1-CC <input type="checkbox"/> 8 - AH2-CC <input type="checkbox"/> 9 - AH2-CC300	<input type="checkbox"/> 2 - 1" NPT or No Nipple	<input type="checkbox"/> 0 - No Bracket

¹ UL and FM approved corrosion resistant coating, and VdS and LPCB recognized and approved alternate coating. Appears chrome in color.

VicFlex™ Sprinkler Fitting Systems

VicFlex™ Style AB6
 Assembly - Cold
 Storage

**INTERCHANGEABLE
 ESCUTCHEONS**

1" NPT Thread
 K5.6, K8.0, K11.2
 Refer to publication 10.90

Size inches	Price Each			
	K5.6, K8.0 Pendent	K11.2 Pendent	K5.6, K8.0 Sidewall	K5.6, K8.0 Concealed
12	\$597.50	\$720.50	\$609.50	\$664.50
18	625.00	750.50	638.00	691.50
24	652.50	780.50	665.50	719.50
30	680.00	810.50	693.50	747.00



VicFlex™ Sprinkler Fitting Systems

VicFlex™ Style AB6 Bracket Assembly Order Form

Order No.	Date
Ship To:	
Company Name	
Address	
State/Province	Zip Code/Postal Code
Tag	

Bill To:	
Company Name	
Address	
State/Province	Zip Code/Postal Code
Phone No.	Email
Fax No.	

Quantity (as specified below): If units of different size, type or other option are required, please attach additional form(s) with their specification(s) separately.

VicFlex™ Style AB6 Bracket Assembly

<input type="checkbox"/> A	<input type="checkbox"/> 3	<input type="checkbox"/> 4	<input type="checkbox"/> UB6	<input type="checkbox"/> 4
----------------------------	----------------------------	----------------------------	------------------------------	----------------------------

Class	Sprinkler Frame	Sprinkler Thread	Deflector Style	Sprinkler Temperature	Sprinkler Response	Sprinkler K-Factor	Sprinkler Finish	Recessed Escutcheon Material ³	Sprinkler Barrel Length	Escutcheon Style	Bracket Style	Hose Style	Hose Length
<input type="checkbox"/> A - VicFlex™	<input type="checkbox"/> 33 - V33 Concealed ⁴ <input type="checkbox"/> 36 - V36 STD PEND/ HOR SIDEWALL <input type="checkbox"/> 40 - V40 STD PEND ¹	<input type="checkbox"/> 3 - 1" NPT	<input type="checkbox"/> B - STD PEND <input type="checkbox"/> C - HOR SIDEWALL ² <input type="checkbox"/> P - CONC PEND	<input type="checkbox"/> C - 155°F/68°C <input type="checkbox"/> F - 200°F/93°C <input type="checkbox"/> J - 286°F/141°C	<input type="checkbox"/> S - Standard <input type="checkbox"/> Q - Quick	<input type="checkbox"/> 4 - 5.6 <input type="checkbox"/> 5 - 8.0 <input type="checkbox"/> 6 - 11.2	<input type="checkbox"/> 4 - White (RAL 9010) <input type="checkbox"/> N - VC250 ⁴	<input type="checkbox"/> 0 - Cold Rolled Steel <input type="checkbox"/> X - Stainless Steel <input type="checkbox"/> W - White (RAL 9010) Painted Stainless Steel	<input type="checkbox"/> 120 - 12" <input type="checkbox"/> 180 - 18" <input type="checkbox"/> 240 - 24" <input type="checkbox"/> 300 - 30" <input type="checkbox"/> 360 - 36"	<input type="checkbox"/> 11 - Flush <input type="checkbox"/> 12 - Recessed <input type="checkbox"/> 13 - Sleeve and Skirt <input type="checkbox"/> 15 - Concealed ⁶ <input type="checkbox"/> 17 - Plain Barrel (Interchangeable Escutcheons)	<input type="checkbox"/> UB6 - AB6	<input type="checkbox"/> 2 - AH2 Hose (NPT) <input type="checkbox"/> 3 - AH2 Hose (BSPT) <input type="checkbox"/> 8 - AH2-CC Hose	<input type="checkbox"/> 4 - 48"

¹ V40 Sprinkler Frame available only as Standard Pendant with K11.2.
² Horizontal Sidewall not available with interchangeable escutcheons.
³ Escutcheon finish will be the same as sprinkler finish.
⁴ UL and FM approved corrosion resistant coating, and V45 and LPCB recognized and approved alternate coating. Appears chrome in color.
⁵ V33 Sprinkler Frame only available with Sprinkler Finish 4 - White (RAL 9010) and recessed escutcheon material 0 - Cold rolled Steel.
⁶ V33 Sprinkler Frame can only be combined with the 15 - Concealed escutcheon style.

VicFlex™ Sprinkler Fitting Systems

VicFlex™ Dry Sprinkler Model VS1

RECESSED OR SLEEVE AND SKIRT PENDENT OR SIDEWALL, CONCEALED PENDENT

1" NPT Thread
K5.6
Refer to publication 10.91



Length inches	Approx. Wgt. Ea. lb	Price Each		Sold in Box Quantities of
		V3505, V3506, V3509, V3510 Recessed or Sleeve and Skirt Pendent or Sidewall	V3517, V3518 Concealed Pendent	
38	3.9	\$631.50	\$698.50	5
50	4.3	676.00	743.50	5
58	4.6	720.50	789.00	5

NOTE: Items listed in shaded areas are non-cancellable and non-returnable.

Note: Sleeve and Skirt escutcheon not compatible with Style VB2 or VB3 brackets.

*** Concealed cover plates must be ordered separately.**

Note: Part Code Order Form on 5-12 page.

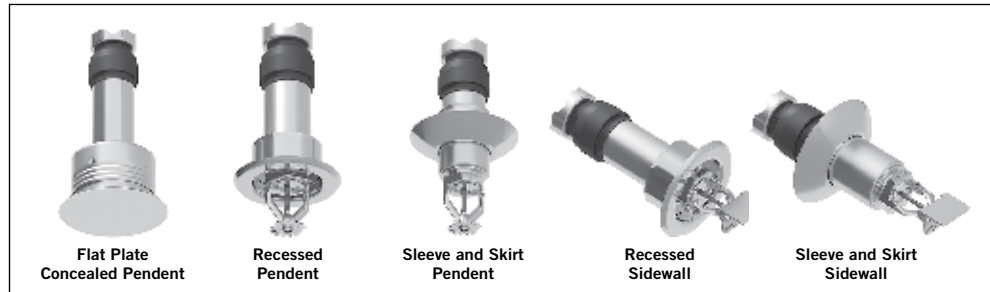

VS1 COVER PLATES

Finish	135° F/57° C		165° F/74° C	
	Part Code	Price	Part Code	Price
Chrome	S3506A0020	\$29.00	S3506D0020	\$29.00
Bright Brass	S3506A0030	29.00	S3506D0030	29.00
White	S3506A0040	29.00	S3506D0040	29.00
Custom	S3506A00_0	+	S3506D00_0	+

NOTE: Items listed in shaded areas are non-cancellable and non-returnable.

For custom finishes, contact Victaulic for details.

+ Quoted on application. Contact Victaulic for pricing and availability.

Clean Room Cover Seal Gasket

Refer to publication 40.53.



Victaulic Part Number	Price Per Bag of 10
S380P00020	\$91.50

VicFlex™ Sprinkler Fitting Systems

VicFlex™ Dry Sprinkler Brackets

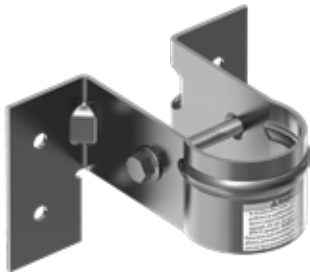

Style VB1



Style VB2



Style VB3



Style VB4



Bracket	Size	Approx. Wgt. Ea.	Victaulic	Price	Sold in Box Quantities of
Description	inches	lb	Part No.	Each	
Style VB1 Wood and metal stud or joist	-	0.2	A000000SLV	\$47.00 ^{NR}	5
Style VB2 Recessed pendent, suspended lay-in tile ceilings	24	1.5	A24TBAR000	137.50 ^{NR}	5
	48	2.7	A48TBAR000	172.50 ^{NR}	5
Style VB3 Concealed pendent, suspended lay-in tile ceilings	24	1.6	A240AQBVB3	137.50 ^{NR}	5
	48	2.9	A480AQBVB3	172.50 ^{NR}	5
Style VB4 Sleeve and skirt pendent, suspended lay-in tile ceilings	24	1.6	A240VB4VS1	137.50 ^{NR}	5
	48	2.9	A480VB4VS1	172.50 ^{NR}	5

^{NR} Non-returnable

VicFlex™ Sprinkler Fitting Systems

VicFlex™ Dry Sprinkler Model VS1 Order Form

Bill To:

Company Name	
Address	
State/Province	
Zip Code/Postal Code	
Phone No.	Email
Fax No.	

Ship To:

Order No.	Date
Company Name	
Address	
State/Province	
Zip Code/Postal Code	
Tag	

Quantity (as specified below):

If units of different size, type or other option are required, please attach additional form(s) with their specification(s) separately.

VicFlex™ Dry Sprinkler Model VS1

Class	Style	Thread	Deflector Style	Temperature	Response	K Factor	Finish	Recessed Escutcheon Material	Size		Escutcheon Style †
									Code	Inches	
A	3F = V35	3 = 1" NPT 8 = 25 mm BSP	B = Pendent C = Horizontal Sidewall P - Concealed	A = 135°F/57°C C = 155°F/68°C E = 175°F/79°C F = 200°F/93°C J = 286°F/141°C	Q = Quick S = Std.	4 = K5.6	4 = White N = VC-250 ‡	W = White Stainless Steel X = Stainless Steel 0 = Concealed	380 = 38" 500 = 50" 580 = 58"	12 = Recessed 13 = Sleeve and Skirt 15 = Concealed	

‡ VC-250 sprinkler finish sold standard on the VicFlex Dry Sprinkler Model VS1.

VicFlex™ Sprinkler Fitting Systems

Series AQC-U Assembly

FOR CLEAN ROOM APPLICATIONS

Refer to publication 10.86



Size inches	Approx. Wgt. Ea. lb	Victaulic Part No.	Price Each
36 x 1/2	2.8	A36HAQC000	\$500.00
48 x 1/2	3.2	A48HAQC000	526.00
72 x 1/2	4.0	A72HAQC000	649.00

NOTE: Items listed in shaded areas are non-cancellable and non-returnable.

NOTE: Please refer to publication 10.86 for certifications and listings.

Series AQD Assembly

FOR DUCT SYSTEMS

Refer to publication 10.87



Size inches	Base Mount Radius	Round Duct Dia.	Approx. Wgt. Ea. lb	Victaulic Part No.	Price Each
24 x 1/2	6.1 Round	12 – 14	2.2	A24HAQD96R	\$1102.00
	9.4 Round	16 – 24	2.2	A24HAQD99R	1102.00
	18.9 Round	26 – 72	2.2	A24HAQD91R	1102.00
	Square	N/A	2.2	A24HAQD96S	1102.00
48 x 1/2	6.1 Round	12 – 14	2.6	A48HAQD96R	1209.50
	9.4 Round	16 – 24	2.6	A48HAQD99R	1209.50
	18.9 Round	26 – 72	2.6	A48HAQD91R	1209.50 ^{NR}
	Square	N/A	2.6	A48HAQD96S	1209.50
72 x 1/2	6.1 Round	12 – 14	3.1	A72HAQD96R	1363.50
	9.4 Round	16 – 24	3.1	A72HAQD99R	1363.50
	18.9 Round	26 – 72	3.1	A72HAQD91R	1363.50
	Square	N/A	3.1	A72HAQD96S	1293.00

NOTE: Items listed in shaded areas are non-cancellable and non-returnable.

^{NR} Non-returnable

Series AQD Assembly

FOR METAL DUCT SYSTEMS

Refer to publication 10.77



Braided Hose Length inches	Base Mount Duct Dia.	Approx. Wgt. Ea. lb	Victaulic Part No.	Price Each
48	Square	7.6	A010AQDBMD	\$850.00
	8 – 12		A080AQDBMD	850.00
	13 – 16		A130AQDBMD	850.00
	17 +		A170AQDBMD	850.00

NOTE: Items listed in shaded areas are non-cancellable and non-returnable.

Sprinkler Bag Replacement Kit *

Victaulic Part Number	Price Each
A000AQDBGK	\$79.00

NOTE: Items listed in shaded areas are non-cancellable and non-returnable.

* Kit includes 3 cellophane bags, 3 polyethylene bags, and 3 FKM retainer rings





Vic-Press™ System for Schedule 10S Stainless Steel Pipe



Vic-Press™ System For Type 304 Schedule 10S Stainless Steel Pipe

Vic-Press™ FOR SCHEDULE 10S

Vic-Press™ System for Type 304 Schedule 10S Stainless Steel Pipe

The Victaulic® Vic-Press™ System for joining Schedule 10S Type 304 (L) stainless steel pipe provides a fast, easy, clean, and reliable means for joining ½ – 2”/15 – 50 mm standard ASTM A312 Schedule 10S stainless steel pipe. Vic-Press™ Schedule 10S products are designed for pressure service up to 500 psi/3450 kPa or ANSI Class 150 (except steam, according to standard temperature/pressure charts) for water, oil, noncombustible gaseous and general chemical services and are dimensioned to ANSI/ASME B36.19M. Refer to seal selection data for the intended service.

The Vic-Press™ Schedule 10S System requires no flame or arc as with welding, and no cutting oil, chips or preparation time as with threading or flanging. Off-the-shelf standard ASTM A312 Schedule 10S stainless steel pipe is cut to size, inserted into the coupling and the coupling or fitting is pressed onto the pipe in seconds.

The Vic-Press™ Schedule 10S System meets the hanging requirements of ASME B31.1, B31.3 and B31.9.

Vic-Press™ Schedule 10S Type 304 couplings and fittings are ANSI/NSF 61 Annex G Certified for cold (+86°F/+30°C) and hot (+180°F/+82°C) potable water service for Grade H and Grade E seal materials. Unless specified otherwise, Grade “H” seals will be applied. FM Approved to 175 psi/1200 kPa service for above ground sprinkler systems.



IMPORTANT PLEASE READ BEFORE ORDERING.
Gasket selection must always be specified on your order.

For information pertaining to gasket seals for couplings, seals for Vic-Press™ products, O-rings for Victaulic® Bolted Split Sleeve products and general definition/seal material Selection, refer to publication 05.01.

For specific chemical and temperature compatibility, refer to the Gasket Chemical Services Guide Long Report (GSG-100).

⚠ WARNING

- **Before attempting to install any Vic-Press™ Schedule 10S System products, carefully read and fully understand the “Vic-Press™ Schedule 10S Products Installation Instructions” (I-P500) and the operating and maintenance manual supplied with the tool.**

Failure to follow these instructions could result in serious personal injury, property damage, product damage, joint leakage, and/or joint failure.

Vic-Press™ System For Type 304 Schedule 10S Stainless Steel Pipe

Style P500

LOOSE SEALS

Refer to publication 18.12

STYLE P500 – SPARE PARTS – LOOSE SEALS

Nominal Size	Price Each †
inches	Standard Grade “H” HNBR or Grade “E” EPDM Seal
½	\$12.50 ^{NR}
¾	13.50 ^{NR}
1	17.00 ^{NR}
1½	21.50 ^{NR}
2	30.00 ^{NR}

† Specify choice clearly on order.

^{NR} Non-returnable

Style P597

STANDARD COUPLING

(P X P)

Refer to publication 18.12

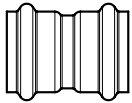

STYLE P597 – WITH STANDARD GRADE “H” HNBR SEAL OR OPTIONAL GRADE “E” SEAL

Nominal Size	Approx. Weight Each	Price Each †
inches	lb	Standard Grade “H” HNBR or Grade “E” EPDM Seal
½	0.2	\$73.50
¾	0.3	81.00
1	0.5	91.00
1½	0.7	121.00
2	1.0	159.00

† Specify choice clearly on order.

Style P596

MALE ADAPTER – THREADED

(P X M)

Refer to publication 18.12

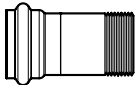

STYLE P596 – WITH STANDARD GRADE “H” HNBR SEAL OR OPTIONAL GRADE “E” SEAL

Nominal Size	Approx. Weight Each	Price Each †
inches	lb	Standard Grade “H” HNBR or Grade “E” EPDM Seal
½ x ½	0.3	\$136.00
¾ x ½	0.4	141.00
¾	0.4	141.00
1	0.5	163.50
1 x ¾	0.5	167.50
1	0.6	167.50
1½ x ¾	0.8	311.00
1½	1.0	278.00
2 x 2	1.4	342.50

† Specify choice clearly on order.

NOTE: Items listed in shaded areas are non-cancellable and non-returnable.

Vic-Press™ System For Type 304 Schedule 10S Stainless Steel Pipe

Series P569

For Series P569 pricing, please refer to Series P569 in the Type 316 section.

TYPE 316 STAINLESS STEEL BALL VALVE WITH LOCKING HANDLE

Refer to publication 18.12

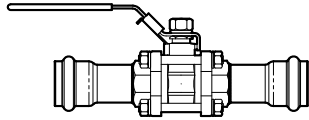

P x P

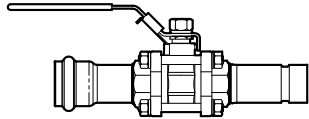

P x G

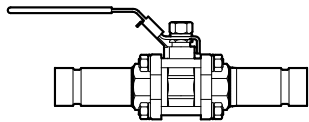

G x G

Series P589

VIC-PRESS™ SCHEDULE 10S SYSTEM BRASS BODY BALL VALVE

Stainless Steel Vic-Press™ Type 304
Schedule 10S Ends

Refer to publication 18.12

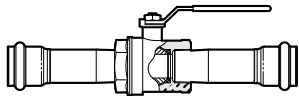

SERIES P589 – VIC-PRESS™ SCHEDULE 10S ENDS WITH STANDARD GRADE “H” HNBR SEAL OR OPTIONAL GRADE “E” SEAL

Nominal Size	Approx. Weight Each	End to End	Price Each †
inches	lb	Inches	Standard Grade “H” HNBR or Grade “E” EPDM Seal
1/2	1.0	9.03	\$426.00
3/4	1.6	9.12	467.50
1	2.8	10.11	560.00
1 1/2	4.7	11.18	784.50
2	6.9	12.69	960.50

† Specify choice clearly on order.

NOTE: Items listed in shaded areas are non-cancellable and non-returnable.

Style P586

90° ELBOW – SHORT TANGENT

(P X P)

Refer to publication 18.12

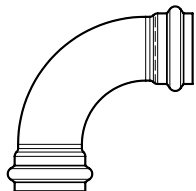

STYLE P586 – WITH STANDARD GRADE “H” HNBR SEAL OR OPTIONAL GRADE “E” SEAL

Nominal Size	Approx. Weight Each	Price Each †
inches	lb	Standard Grade “H” HNBR or Grade “E” EPDM Seal
1/2	0.3	\$135.50
3/4	0.4	152.50
1	0.8	181.00
1 1/2	1.4	355.00
2	2.0	453.50

† Specify choice clearly on order.

Vic-Press™ System For Type 304 Schedule 10S Stainless Steel Pipe

Style P542

90° STREET ELBOW

(P X T)
Refer to publication 18.12

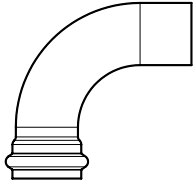

STYLE P542 – WITH STANDARD GRADE “H” HNBR SEAL OR OPTIONAL GRADE “E” SEAL

Nominal Size	Approx. Weight Each	Price Each †
inches	lb	Standard Grade “H” HNBR or Grade “E” EPDM Seal
½	0.3	\$135.50
¾	0.4	152.50
1	0.7	181.00
1½	1.4	355.00
2	2.0	453.50

† Specify choice clearly on order.

Style P591

45° ELBOW

(P X P)
Refer to publication 18.12

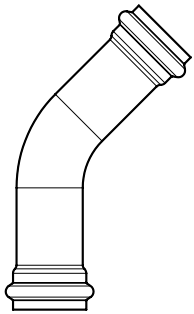

STYLE P591 – WITH STANDARD GRADE “H” HNBR SEAL OR OPTIONAL GRADE “E” SEAL

Nominal Size	Approx. Weight Each	Price Each †
inches	lb	Standard Grade “H” HNBR or Grade “E” EPDM Seal
½	0.2	\$120.50
¾	0.4	133.50
1	0.8	158.50
1½	1.7	309.00
2	2.5	395.50

† Specify choice clearly on order.

Style P543

45° STREET ELBOW

(P X T)
Refer to publication 18.12

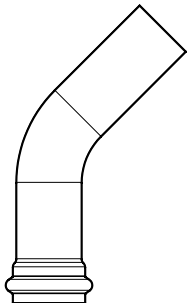

STYLE P543 – WITH STANDARD GRADE “H” HNBR SEAL OR OPTIONAL GRADE “E” SEAL

Nominal Size	Approx. Weight Each	Price Each †
inches	lb	Standard Grade “H” HNBR or Grade “E” EPDM Seal
½	0.2	\$120.50
¾	0.4	133.50
1	0.8	158.50
1½	1.7	309.00
2	2.5	395.50

† Specify choice clearly on order.

NOTE: Items listed in shaded areas are non-cancellable and non-returnable.

Vic-Press™ System For Type 304 Schedule 10S Stainless Steel Pipe

Style P592

TEE

(P X P X P)
Refer to publication 18.12

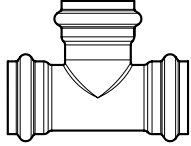

STYLE P592 – WITH STANDARD GRADE “H” HNBR SEAL OR OPTIONAL GRADE “E” SEAL

Nominal Size	Approx. Weight Each	Price Each †
		Standard Grade “H” HNBR or Grade “E” EPDM Seal
inches	lb	
1/2	0.4	\$244.50
3/4	0.5	269.50
1	0.9	288.50
1 1/2	1.5	369.00
2	2.1	458.00

† Specify choice clearly on order.

Style P593

TEE – REDUCING BRANCH

(P X P X P)
Refer to publication 18.12

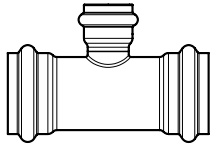

STYLE P593 – WITH STANDARD GRADE “H” HNBR SEAL OR OPTIONAL GRADE “E” SEAL

Nominal Size	Approx. Weight Each	Price Each †
		Standard Grade “H” HNBR or Grade “E” EPDM Seal
inches	lb	
3/4 x 3/4 x 1/2	0.5	\$271.50
1 x 1 x 1/2	0.8	280.50
	0.8	287.50
	1.2	338.50
1 1/2 x 1 1/2 x 1/2	1.2	338.50
	1.3	342.00
	1.4	343.50
2 x 2 x 1/2	1.7	440.00
	1.7	447.00
	1.8	459.00
	2.0	506.00

† Specify choice clearly on order.

NOTE: Items listed in shaded areas are non-cancellable and non-returnable.

Style P588

TEE – REDUCING BRANCH – THREADED

(P X P X F)
Refer to publication 18.12

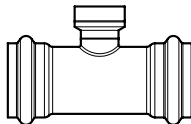

STYLE P588 – WITH STANDARD GRADE “H” HNBR SEAL OR OPTIONAL GRADE “E” SEAL

Nominal Size	Approx. Weight Each	Price Each †
		Standard Grade “H” HNBR or Grade “E” EPDM Seal
inches	lb	
1/2 x 1/2 x 1/2	0.4	\$369.00
3/4 x 3/4 x 1/2	0.5	399.50
	0.6	403.00
	0.9	406.00
1 x 1 x 1/2	0.9	407.50
	1.1	442.50
	1.4	459.00
1 1/2 x 1 1/2 x 1/2	1.4	459.00
	1.5	464.50
	1.5	507.00
2 x 2 x 1/2	1.7	524.00
	1.7	528.50
	2.0	567.00

† Specify choice clearly on order.

NOTE: Items listed in shaded areas are non-cancellable and non-returnable.

Vic-Press™ System For Type 304 Schedule 10S Stainless Steel Pipe

Style P594

CONCENTRIC REDUCER

(P X P)

Refer to publication 18.12

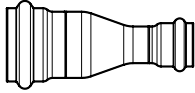

STYLE P594 – WITH STANDARD GRADE “H” HNBR SEAL OR OPTIONAL GRADE “E” SEAL

Nominal Size	Approx. Weight Each		Price Each †	
			Standard Grade “H” HNBR or Grade “E” EPDM Seal	
inches		lb		
¾ x ½		0.5		\$221.50
1 x ¾		0.6		297.50
		0.7		237.00
1½ x 1		0.9		417.50
		1.0		391.50
		1.1		218.50
2 x 1½		1.2		772.50
		1.3		349.00
		1.4		269.50
		1.6		269.50

† Specify choice clearly on order.

NOTE: Items listed in shaded areas are non-cancellable and non-returnable.

Style P595

FLANGE ADAPTER

(P X L)

Refer to publication 18.12

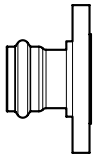

STYLE P595 – WITH STANDARD GRADE “H” HNBR SEAL OR OPTIONAL GRADE “E” SEAL

Nominal Size	Approx. Weight Each		Price Each †	
			Standard Grade “H” HNBR or Grade “E” EPDM Seal	
inches		lb		
½		2.2		\$992.00
¾		2.3		1021.50
1		2.8		1037.00
1½		3.6		1263.00
2		5.8		1406.50

† Specify choice clearly on order.

Style P565

FLANGE ADAPTER (VAN STONE TYPE)

(P X L)

Refer to publication 18.12

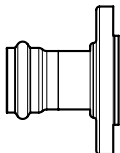

STYLE P565 – WITH STANDARD GRADE “H” HNBR SEAL OR OPTIONAL GRADE “E” SEAL

Nominal Size	Approx. Weight Each		Price Each †	
			Standard Grade “H” HNBR or Grade “E” EPDM Seal	
inches		lb		
½		2.4		\$347.50
¾		2.5		347.50
1		3.0		467.50
1½		4.1		515.00
2		6.8		552.50

† Specify choice clearly on order.

NOTE: Items listed in shaded areas are non-cancellable and non-returnable.

NOTE: Items listed in shaded areas are non-cancellable and non-returnable.

Vic-Press™ System For Type 304 Schedule 10S Stainless Steel Pipe

Style P587

TRANSITION NIPPLE

(T X G)

Refer to publication 18.12



STYLE P587

Nominal Size	Approx. Weight Each Unit	End to End	Price
inches	lb	Inches	Each
¾	0.3	4	\$184.00
1	0.5	4	190.50
1½	0.7	4	238.00
2	0.9	4	249.00

† Specify choice clearly on order.

NOTE: Items listed in shaded areas are non-cancellable and non-returnable.

Style P584

THREADED UNION **

(P X P)

Refer to publication 18.12

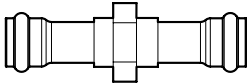

STYLE P584 – WITH STANDARD GRADE “H” HNBR SEAL OR OPTIONAL GRADE “E” SEAL

Nominal Size	Approx. Weight Each	Price Each †
inches	lb	Standard Grade “H” HNBR or Grade “E” EPDM Seal
½	3.0	\$815.00
¾	3.7	925.50
1	4.3	1126.00
1½	6.0	1924.00
2	6.8	2371.00

† Specify choice clearly on order.

** Grooved End Union - A grooved end union can be formed with two Style P587 (Type 304 stainless) transition nipples (see above) and a variety of grooved end couplings equipped with varied gasket materials to meet service requirements. For standard ductile iron couplings, stainless steel couplings and gaskets refer to the Stainless Steel Products section.

NOTE: Items listed in shaded areas are non-cancellable and non-returnable.

Style P599

FEMALE ADAPTER – THREADED

(P X F)

Refer to publication 18.12

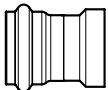

STYLE P599 – WITH STANDARD GRADE “H” HNBR SEAL OR OPTIONAL GRADE “E” SEAL

Nominal Size	Approx. Weight Each	Price Each †
inches	lb	Standard Grade “H” HNBR or Grade “E” EPDM Seal
½ x ½	0.3	\$166.00
¾ x ½	0.3	166.50
¾ x ¾	0.4	169.50
1 x ½	0.7	178.50
1 x ¾	0.6	191.00
1 x 1	0.6	202.50
1½ x 1	1.0	319.00
1½ x 1¼	0.8	360.00
1½ x 1½	1.0	400.50
2 x 1¼	1.1	467.00
2 x 1½	1.3	394.50
2 x 2	1.2	434.50

† Specify choice clearly on order.

NOTE: Items listed in shaded areas are non-cancellable and non-returnable.

Vic-Press™ System For Type 304 Schedule 10S Stainless Steel Pipe

Style P561

WELD ADAPTER

(P X T)

Refer to publication 18.12

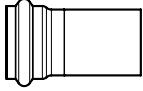

STYLE P561 – WITH STANDARD GRADE “H” HNBR SEAL OR OPTIONAL GRADE “E” SEAL

Nominal Size	Approx. Weight Each	Price Each †
inches	lb	Standard Grade “H” HNBR or Grade “E” EPDM Seal
½	0.3	\$132.50
¾	0.4	137.00
1	0.6	162.00
1½	0.9	280.50
2	1.4	332.00

† Specify choice clearly on order.

NOTE: Items listed in shaded areas are non-cancellable and non-returnable.

Style P540

END CAP

Refer to publication 18.12



STYLE P540

Nominal Size	Approx. Weight Each	Price Each
inches	lb	Each
½	0.1	\$169.00
¾	0.1	186.50
1	0.3	199.00
1½	0.4	254.50
2	0.5	316.50

NOTE: Items listed in shaded areas are non-cancellable and non-returnable.

PFT510

Vic-Press 10S Tool

The Vic-Press Schedule 10S System requires a tool specifically designed for products on off-the-shelf standard ASTM A312 Schedule 10S stainless steel pipe. Refer to Pipe Preparation Tools section for prices and where to call for purchase information.

NOTE: Victaulic Tool Discount will apply.



PFT510 Tool

Vic-Press™ System For Type 316 Schedule 10S Stainless Steel Pipe

Vic-Press™ FOR SCHEDULE 10S

Vic-Press™ System for Type 316 Schedule 10S Stainless Steel Pipe

The Victaulic® Vic-Press™ System for joining Schedule 10S Type 316 (L) stainless steel pipe provides a fast, easy, clean, and reliable means for joining ½ – 2”/15 – 50 mm standard ASTM A312 Schedule 10S stainless steel pipe. Vic-Press™ Schedule 10S products are designed for pressure service up to 500 psi/3450 kPa or ANSI Class 150 (except steam, according to standard temperature/pressure charts) for water, oil, noncombustible gaseous and general chemical services and are dimensioned to ANSI/ASME B36.19M. Refer to seal selection data for the intended service.

The Vic-Press™ Schedule 10S System eliminates the need for flame as in welding, no cutting oil, chips or preparation time as with threading or flanging. Off-the-shelf standard ASTM A312 Schedule 10S stainless steel pipe is cut to size, inserted into the coupling and the coupling is pressed onto the pipe and fitting in seconds.

The Vic-Press™ Schedule 10S System meets the hanging requirements of ASME B31.1, B31.3 and B31.9.

Vic-Press™ Type 316 couplings and fittings are recommended for varying concentrations of hot petroleum/water mixtures, hydrocarbons, air with oil vapors, vegetable and mineral oils, as well as automotive fluids such as engine oil and transmission fluid within the temperature range of –20°F to +210°F/–29°C to +98°C. UL Classified in accordance with ANSI/NSF 61 Annex G for cold (+86°F/+30°C) and hot (+180°F/+82°C) potable water service for Grade H and Grade E seal materials. Unless specified otherwise, Grade “H” seals will be applied. FM Approved to 175 psi/1200 kPa service for above ground sprinkler systems.



IMPORTANT PLEASE READ BEFORE ORDERING.
Gasket selection must always be specified on your order.

For information pertaining to gasket seals for couplings, seals for Vic-Press™ products, O-rings for Victaulic® Bolted Split Sleeve products and general definition/seal material Selection, refer to publication 05.01.

For specific chemical and temperature compatibility, refer to the Gasket Chemical Services Guide Long Report (GSG-100).

⚠ WARNING

- Before attempting to install any Vic-Press™ Schedule 10S System products, carefully read and fully understand the “Vic-Press™ Schedule 10S Products Installation Instructions” (I-P500) and the operating and maintenance manual supplied with the tool.

Failure to follow these instructions could result in serious personal injury, property damage, product damage, joint leakage, and/or joint failure.

Vic-Press™ System For Type 316 Schedule 10S Stainless Steel Pipe

Style P500

LOOSE SEALS

Refer to publication 18.11

STYLE P500 – SPARE PARTS – LOOSE SEALS

Nominal Size	Price Each †
inches	Standard Grade “H” HNBR or Grade “E” EPDM Seal
½	\$12.50 ^{NR}
¾	13.50 ^{NR}
1	17.00 ^{NR}
1½	21.50 ^{NR}
2	30.00 ^{NR}

† Specify choice clearly on order.

^{NR} Non-returnable

Style P507

STANDARD COUPLING

(P X P)

Refer to publication 18.11

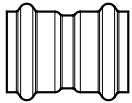

STYLE P507 – WITH STANDARD GRADE “H” HNBR SEAL OR OPTIONAL GRADE “E” SEAL

Nominal Size	Approx. Weight Each	Price Each †
inches	lb	Standard Grade “H” HNBR or Grade “E” EPDM Seal
½	0.2	\$82.00
¾	0.3	92.00
1	0.5	103.50
1½	0.7	143.00
2	1.0	206.50

† Specify choice clearly on order.

Style P576

MALE ADAPTER – THREADED

(P X M)

Refer to publication 18.11

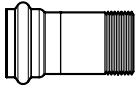

STYLE P576 – WITH STANDARD GRADE “H” HNBR SEAL OR OPTIONAL GRADE “E” SEAL

Nominal Size	Approx. Weight Each	Price Each †
inches	lb	Standard Grade “H” HNBR or Grade “E” EPDM Seal
½ x ½	0.3	\$140.00
¾ x ½	0.4	146.50
¾ x ¾	0.4	146.50
1	0.5	168.50
1 x ¾	0.5	172.00
1	0.6	172.00
1½ x ¾	0.8	314.00
1½ x 1½	1.0	355.50
2 x 2	1.4	462.00

† Specify choice clearly on order.

NOTE: Items listed in shaded areas are non-cancellable and non-returnable.

Vic-Press™ System For Type 316 Schedule 10S Stainless Steel Pipe

Style P508

SLIP COUPLING

(P X P)
Refer to publication 18.11

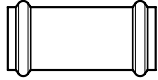

STYLE P508 – WITH STANDARD GRADE “H” HNBR SEAL OR OPTIONAL GRADE “E” SEAL

Nominal Size	Approx. Weight Each	Price Each †
inches	lb	Standard Grade “H” HNBR or Grade “E” EPDM Seal
1/2	0.3	\$96.00
3/4	0.4	103.50
1	0.7	119.00
1 1/2	1.1	152.50
2	1.6	194.00

† Specify choice clearly on order.

NOTE: Items listed in shaded areas are non-cancellable and non-returnable.

Series P569

TYPE 316 STAINLESS STEEL BALL VALVE WITH LOCKING HANDLE

Refer to publication 18.11

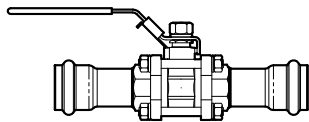

P x P

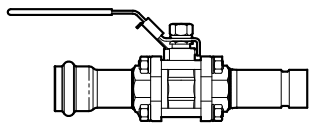

P x G

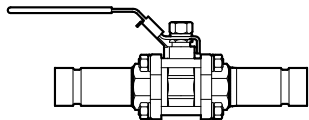

G x G

SERIES P569 – VIC-PRESS SCHEDULE 10S X VIC-PRESS SCHEDULE 10S (P X P)

Nominal Size	Approx. Weight Each	End to End	Price Each Vic-Press x Vic-Press (P X P) †
inches	lb	Inches	Standard Grade “H” HNBR or Grade “E” EPDM Seal
1/2	1.5	8.43	\$568.50
3/4	2.4	8.63	661.00
1	3.6	9.22	794.00
1 1/2	6.9	10.11	1232.50
2	9.5	10.46	1652.50

SERIES P569 VIC-PRESS SCHEDULE 10S X GROOVED (P X G)

Nominal Size	Approx. Weight Each	End to End	Price Each Vic-Press x Grooved (P X G) †
inches	lb	Inches	Standard Grade “H” HNBR or Grade “E” EPDM Seal
3/4	2.4	8.72	\$661.00
1	3.6	9.21	794.00
1 1/2	6.9	10.68	1232.50
2	9.5	11.60	1652.50

SERIES P569 GROOVED X GROOVED (G X G)

Nominal Size	Approx. Weight Each	End to End	Price Each Grooved x Grooved (G X G)
inches	lb	Inches	
3/4	2.4	8.81	\$575.00
1	3.6	9.20	696.50
1 1/2	6.9	11.24	1097.00
2	9.5	12.74	1455.00

NOTE: Items listed in shaded areas are non-cancellable and non-returnable.

† Specify choice clearly on order.

Vic-Press™ System For Type 316 Schedule 10S Stainless Steel Pipe

Series P569

REPAIR KITS

Refer to publication 18.11

SERIES P569 REPAIR KITS

Nominal Size inches	Price Each	
	Type 316 Stainless Steel Ball	Stem
1/2	\$108.50	+
3/4	103.00	+
1	128.00	+
1 1/2	276.00	+
2	466.50	+

NOTE: Items listed in shaded areas are non-cancellable and non-returnable.

+ Quoted on application. Contact Victaulic for pricing and availability.

Series P589

VIC-PRESS™ SCHEDULE 10S SYSTEM BRASS BODY BALL VALVE

Stainless Steel Vic-Press™ Type 316 Schedule 10S Ends
Refer to publication 18.11

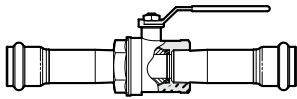

SERIES P589 – VIC-PRESS™ SCHEDULE 10S ENDS WITH STANDARD GRADE “H” HNBR SEAL OR OPTIONAL GRADE “E” SEAL

Nominal Size inches	Approx. Weight Each lb	End to End Inches	Price Each †
			Standard Grade “H” HNBR or Grade “E” EPDM Seal
1/2	1.0	9.03	\$434.50
3/4	1.6	9.12	476.00
1	2.8	10.11	570.50
1 1/2	4.7	11.18	935.00
2	6.9	12.69	1190.00

† Specify choice clearly on order.

NOTE: Items listed in shaded areas are non-cancellable and non-returnable.

Style P568

90° ELBOW – SHORT TANGENT

(P X P)
Refer to publication 18.11

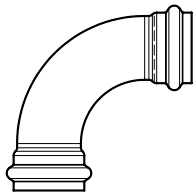

STYLE P568 – WITH STANDARD GRADE “H” HNBR SEAL OR OPTIONAL GRADE “E” SEAL

Nominal Size inches	Approx. Weight Each lb	Price Each †
		Standard Grade “H” HNBR or Grade “E” EPDM Seal
1/2	0.3	\$257.50
3/4	0.4	290.00
1	0.8	325.00
1 1/2	1.4	439.00
2	2.0	602.50

† Specify choice clearly on order.

Style P562

90° STREET ELBOW

(P X T)
Refer to publication 18.11

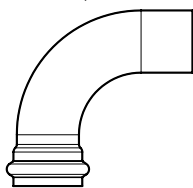

STYLE P562 – WITH STANDARD GRADE “H” HNBR SEAL OR OPTIONAL GRADE “E” SEAL

Nominal Size inches	Approx. Weight Each lb	Price Each †
		Standard Grade “H” HNBR or Grade “E” EPDM Seal
1/2	0.3	\$257.50
3/4	0.4	290.00
1	0.7	325.00
1 1/2	1.4	439.00
2	2.0	602.50

† Specify choice clearly on order.

NOTE: Items listed in shaded areas are non-cancellable and non-returnable.

Vic-Press™ System For Type 316 Schedule 10S Stainless Steel Pipe

Style P571

45° ELBOW

(P X P)

Refer to publication 18.11

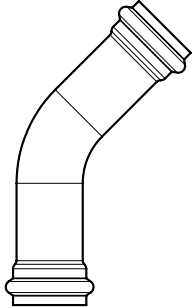

STYLE P571 – WITH STANDARD GRADE “H” HNBR SEAL OR OPTIONAL GRADE “E” SEAL

Nominal Size	Approx. Weight Each	Price Each †
inches	lb	Standard Grade “H” HNBR or Grade “E” EPDM Seal
1/2	0.2	\$237.00
3/4	0.4	254.50
1	0.8	285.00
1 1/2	1.7	381.50
2	2.5	523.50

† Specify choice clearly on order.

NOTE: Items listed in shaded areas are non-cancellable and non-returnable.

Style P563

45° STREET ELBOW

(P X T)

Refer to publication 18.11

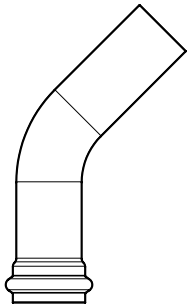

STYLE P563 – WITH STANDARD GRADE “H” HNBR SEAL OR OPTIONAL GRADE “E” SEAL

Nominal Size	Approx. Weight Each	Price Each †
inches	lb	Standard Grade “H” HNBR or Grade “E” EPDM Seal
1/2	0.2	\$237.00
3/4	0.4	254.50
1	0.8	285.00
1 1/2	1.7	381.50
2	2.5	523.50

† Specify choice clearly on order.

NOTE: Items listed in shaded areas are non-cancellable and non-returnable.

Style P572

TEE

(P X P X P)

Refer to publication 18.11

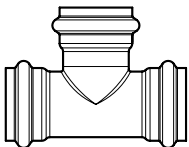

STYLE P572 – WITH STANDARD GRADE “H” HNBR SEAL OR OPTIONAL GRADE “E” SEAL

Nominal Size	Approx. Weight Each	Price Each †
inches	lb	Standard Grade “H” HNBR or Grade “E” EPDM Seal
1/2	0.4	\$554.50
3/4	0.5	599.00
1	0.9	628.00
1 1/2	1.5	739.50
2	2.1	912.50

† Specify choice clearly on order.

NOTE: Items listed in shaded areas are non-cancellable and non-returnable.

Vic-Press™ System For Type 316 Schedule 10S Stainless Steel Pipe

Style P573

TEE – REDUCING BRANCH

(P X P X P)

Refer to publication 18.11

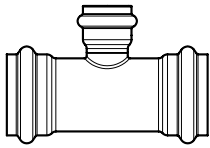

STYLE P573 – WITH STANDARD GRADE “H” HNBR SEAL OR OPTIONAL GRADE “E” SEAL

Nominal Size			Approx. Weight Each		Price Each †
inches			lb		Standard Grade “H” HNBR or Grade “E” EPDM Seal
¾	x	¾	x	½	\$632.50
			x	¾	687.00
1	x	1	x	½	714.50
			x	¾	1009.00
			x	1	1016.50
			x	1½	1040.50
2	x	2	x	½	1179.00
			x	¾	1214.00
			x	1	1352.50
			x	1½	1388.00

† Specify choice clearly on order.

NOTE: Items listed in shaded areas are non-cancellable and non-returnable.

Style P578

TEE – REDUCING BRANCH THREADED

(P X P X F)

Refer to publication 18.11

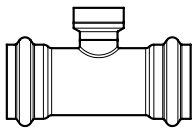

STYLE P578 – WITH STANDARD GRADE “H” HNBR SEAL OR OPTIONAL GRADE “E” SEAL

Nominal Size			Approx. Weight Each		Price Each †
inches			lb		Standard Grade “H” HNBR or Grade “E” EPDM Seal
½	x	½	x	½	\$772.00
			x	¾	855.00
1	x	1	x	½	877.00
			x	¾	937.00
			x	1	953.50
			x	1½	1026.00
1½	x	1½	x	½	1120.00
			x	¾	1160.50
			x	1	1206.50
			x	1½	1235.00
2	x	2	x	½	1280.00
			x	¾	1356.50
			x	1	

† Specify choice clearly on order.

NOTE: Items listed in shaded areas are non-cancellable and non-returnable.

Vic-Press™ System For Type 316 Schedule 10S Stainless Steel Pipe

Style P574

CONCENTRIC REDUCER

(P X P)
Refer to publication 18.11

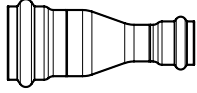

STYLE P574 – WITH STANDARD GRADE “H” HNBR SEAL OR OPTIONAL GRADE “E” SEAL

Nominal Size		Approx. Weight Each	Price Each †
inches		lb	Standard Grade “H” HNBR or Grade “E” EPDM Seal
¾	x ½	0.5	\$260.00
	x ¾	0.6	331.00
1	x ½	0.7	244.50
	x ¾	0.9	488.50
	x 1	1.0	321.50
1½	x ½	1.1	226.50
	x ¾	1.2	843.50
	x 1	1.3	369.50
	x 1½	1.4	277.50
2	x 1½	1.6	277.50

† Specify choice clearly on order.

NOTE: Items listed in shaded areas are non-cancellable and non-returnable.

Style P575

FLANGE ADAPTER

(P X L)
Refer to publication 18.11

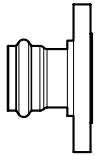

STYLE P575 – WITH STANDARD GRADE “H” HNBR SEAL OR OPTIONAL GRADE “E” SEAL

Nominal Size	Approx. Weight Each	Price Each †
inches	lb	Standard Grade “H” HNBR or Grade “E” EPDM Seal
½	2.2	\$1008.00
¾	2.3	1026.00
1	2.8	1049.50
1½	3.6	1272.00
2	5.8	1413.00

NOTE: Items listed in shaded areas are non-cancellable and non-returnable.

† Specify choice clearly on order.

Style P566

FLANGE ADAPTER (VAN STONE TYPE)

(P X L)
Refer to publication 18.11

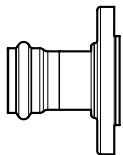

STYLE P566 – WITH STANDARD GRADE “H” HNBR SEAL OR OPTIONAL GRADE “E” SEAL

Nominal Size	Approx. Weight Each	Price Each †
inches	lb	Standard Grade “H” HNBR or Grade “E” EPDM Seal
½	2.4	\$347.50
¾	2.5	347.50
1	3.0	467.50
1½	4.1	515.00
2	6.8	552.50

† Specify choice clearly on order.

NOTE: Items listed in shaded areas are non-cancellable and non-returnable.

Vic-Press™ System For Type 316 Schedule 10S Stainless Steel Pipe

Style P577

ADAPTER NIPPLE

(T X G)

Refer to publication 18.11



STYLE P577

Nominal Size	Approx. Weight Each	Price
inches	lb	Each
3/4	0.3	\$190.00
1	0.5	196.50
1 1/2	0.7	245.50
2	0.9	255.00

NOTE: Items listed in shaded areas are non-cancellable and non-returnable.

Style P585

THREADED UNION **

(P X P)

Refer to publication 18.11

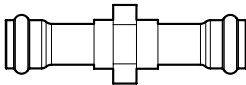

STYLE P585 – WITH STANDARD GRADE “H” HNBR SEAL OR OPTIONAL GRADE “E” SEAL

Nominal Size	Approx. Weight Each	Price Each †
inches	lb	Standard Grade “H” HNBR or Grade “E” EPDM Seal
1/2	3.0	\$834.50
3/4	3.7	961.50
1	4.3	1173.50
1 1/2	6.0	1940.50
2	6.8	2564.00

† Specify choice clearly on order.

** Grooved End Union - A grooved end union can be formed with two Style P587 (Type 304 stainless) transition nipples (see above) and a variety of grooved end couplings equipped with varied gasket materials to meet service requirements. For standard ductile iron couplings, stainless steel couplings and gaskets refer to the Stainless Steel Products section.

NOTE: Items listed in shaded areas are non-cancellable and non-returnable.

Style P579

FEMALE ADAPTER – THREADED

(P X F)

Refer to publication 18.11

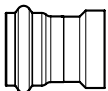

STYLE P579 – WITH STANDARD GRADE “H” HNBR SEAL OR OPTIONAL GRADE “E” SEAL

Nominal Size	Approx. Weight Each	Price Each †
inches	lb	Standard Grade “H” HNBR or Grade “E” EPDM Seal
1/2 x 1/2	0.3	\$184.50
3/4 x 1/2	0.3	192.50
3/4 x 3/4	0.4	195.50
1 x 1/2	0.7	205.50
1 x 3/4	0.6	217.50
1 x 1	0.6	228.50
1 1/2 x 1	1.0	381.00
1 1/2 x 1 1/4	0.8	381.00
1 1/2 x 1 1/2	1.0	477.00
2 x 1 1/4	1.1	473.50
2 x 1 1/2	1.3	473.50
2 x 2	1.2	519.00

† Specify choice clearly on order.

NOTE: Items listed in shaded areas are non-cancellable and non-returnable.

Vic-Press™ System For Type 316 Schedule 10S Stainless Steel Pipe

P560

END CAP

Refer to publication 18.11

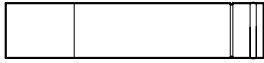

STYLE P560 END CAP

Nominal Size inches	Approx. Weight Each lb	Price Each
1/2	0.1	\$383.00
3/4	0.1	414.00
1	0.3	434.50
1 1/2	0.4	511.00
2	0.5	628.50

NOTE: Items listed in shaded areas are non-cancellable and non-returnable.

PFT510

Vic-Press 10S Tool

The Vic-Press Schedule 10S System requires a tool specifically designed for products on off-the-shelf standard ASTM A312 Schedule 10S stainless steel pipe. Refer to Pipe Preparation Tools section for prices and where to call for purchase information.

NOTE: Victaulic Tool Discount will apply.



PFT510 Tool

Pipe Preparation Tools



Pipe Preparation Tools

Roll Grooving Tools – Field Portable

RG1

The RG1 utilizes the Victaulic proprietary IGS™ groove profile and is designed for manual grooving of 1"/DN25 carbon steel pipe.



Tool Model	Part Number	Tool Weight/Shipping Weight lb	Tool List Price
RG1	R000012IGS	17/20	\$1219.00

For tool rating capacity please reference publication 24.01.

VE12

VE12 is designed for manual grooving of ¾ – 2"/DN20 – DN50 steel, stainless steel, aluminum and PVC pipe.

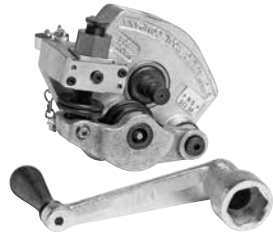

Tool Model	Part Number	Tool Weight/Shipping Weight lb	Rental Per Month	Tool List Price
VE12	R000012VE0	17/20	\$1244.50	\$2676.00
VE12SS – Lightwall Stainless Steel	R200012VE0	17/20	1244.50	2676.00

For tool rating capacity please reference publication 24.01.

NOTE: Items listed in shaded areas are non-cancellable and non-returnable.

VE26

VE26 is designed for manual grooving of 2 – 6"/DN50 – DN150 steel, stainless steel, aluminum, PVC, and copper tube.

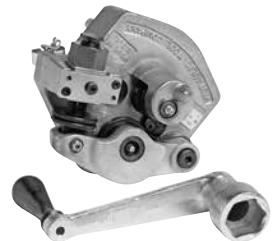

Tool Model	Part Number	Tool Weight/Shipping Weight lb	Rental Per Month	Tool List Price
VE26S – Steel, Stainless Steel	R100026VE0	22/25	\$1182.00	\$2537.50
VE26C – Copper Tube	R200026VE0	22/25	1182.00	2537.50
VE26SS – Lightwall Stainless Steel	R700026VE0	22/25	1182.00	2537.50
VE26P – Aluminum and PVC Pipe	R750026VE0	22/25	1182.00	2537.50

For tool rating capacity please reference publication 24.01.

NOTE: Items listed in shaded areas are non-cancellable and non-returnable.

VE26/VE46 Power Drive Kit

The power drive kit allows for the VE26 and VE46 family of Groove In-Place manual roll grooving tools to be operated with a stationary power drive.



Tool Model	Part Number	Tool Weight/Shipping Weight lb	Tool List Price
VE26/VE46 Power Drive Kit	R075026KIT	7/9	\$471.50

NOTE: Items listed in shaded areas are non-cancellable and non-returnable.

Pipe Preparation Tools

VE46

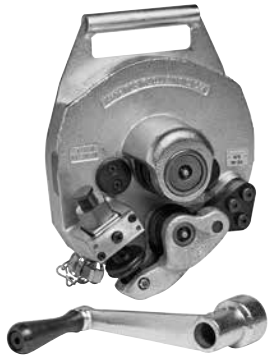

VE46 is designed for manual grooving of 3½ – 6"/90 – 150 steel, stainless steel, aluminum and PVC.

Tool Model	Part Number	Tool Weight/ Shipping Weight lb	Rental Per Month	Tool List Price
VE46 – Steel	R000046VE0	28/31	\$1299.00	\$3069.00
VE46P – Aluminum and PVC Plastic	R200046VE0	28/31	1299.00	3069.00

For tool rating capacity please reference publication 24.01.

NOTE: Items listed in shaded areas are non-cancellable and non-returnable.

VE226 B/S/M/C/BSS/ MSS/P †

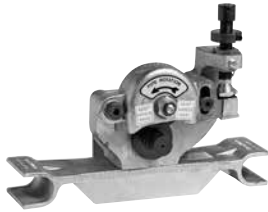

The VE226 family of tools is designed to be operated using a standard ⅝"/9.5 mm square drive socket wrench (not included), for roll grooving the following ¾-6"/DN20-DN150 IPS pipe: steel, stainless steel, aluminum, and PVC. It can also roll groove 2-6" CTS Copper tube. Included are feeler gauges and allen wrench for depth stop setting. Built-on mount fits Ridgid 300" power drives (optional: drive mounts are available for the following power drives: Oster 310, Ridgid 535, Ridgid 1224, and Ridgid 1822).

Tool Model	Part Number	Tool Weight/ Shipping Weight lb	Rental Per Month	Tool List Price ^
VE226B – ¾ – 1½"/20 – 40 mm	R2022260FS	27/42	\$1289.00	\$2842.00
VE226S – 1¼ – 6"/32 – 150 mm	R2002260FS	27/42	1289.00	2842.00
VE226M – 2 – 6"/50 – 150 mm	R3002260FS	27/42	1289.00	2842.00
VE226C – 2 – 6"/50 – 150 mm	R1002260FS	27/42	1289.00	2842.00
VE226BSS – ¾ – 1½"/20 – 40 mm	R00X2260FS	27/42	1289.00	2842.00
VE226MSS – 2 – 6"/50 – 150 mm	RXM02260FS	27/42	1289.00	2842.00
VE226P – 2 – 6"/50 – 150 mm	R6002260FS	27/42	1289.00	2842.00

† NOTE: When ordering tools that require a power drive, you must determine the type of drive to be used.

^ For proper operation, a power drive and pipe stand are required. See Accessories for details.

For tool rating capacity please reference publication 24.01.

NOTE: Items listed in shaded areas are non-cancellable and non-returnable.

VE226 Power Drive Kit Kit for connecting a VE226 Roll Grooving Tool to a Ridgid * 700 Power Drive.



Tool Model	Part Number	Tool Weight/ Shipping Weight lb	Tool List Price
VE226 Power Drive Kit †	R700226KIT	75/115	\$4620.50

† Drive unit not included.

* Ridgid™ is a trademark of Ridgid, Inc. Victaulic is not associated with Ridgid, Inc.

NOTE: Items listed in shaded areas are non-cancellable and non-returnable.

Pipe Preparation Tools

Roll Grooving Tool

RG2100 FOR 1" FIRELOCK™ IGS™ GROOVES



RG2100 FOR 1" FIRELOCK™ IGS™ GROOVES

Tool Model	Part Number	Tool Weight lb	Tool List Price
RG2100 – carriage, grooving head, lever, cutter and reamer	R1002100RG	54.0	\$4234.00
RG2100L – carriage, grooving head and lever	R1502100RG	40.0	3352.00
RG2100 – grooving head	R050210ASY	22.7	2597.00

Note: Tool assembly includes: carriage, groover, cutter, reamer and lever.

For tool rating capacity please reference publication 10.54.

NOTE: Items listed in shaded areas are non-cancellable and non-returnable.

RG2100 REPLACEMENT PARTS

Description	Part Number	Price Each
Carriage	R056210ASY	\$307.50
Threading Adapter	R057210ASY	85.00

NOTE: Items listed in shaded areas are non-cancellable and non-returnable.

Pipe Preparation Tools

Roll Grooving Tools – Field Fabrication

VE106 Groove-N-Go

VE106 portable roll grooving tool with a self-contained power drive provides capability of grooving 1¼ – 6”/32 – 150 pipe, up to and including Schedule 40. The tool can be offered in the following power configurations: 110V & 15 amp or 220V & 6 amps. Tool is supplied complete with 1¼ – 3”/32 – 80 carbon steel roll sets; 4 – 6”/100 – 150 carbon steel rolls are installed.



Tool Model	Part Number	Tool Weight/ Shipping Weight lb.	Rental Per Month	Tool List Price
VE106 Groove-N-Go 110V	R000106110	140/200	\$1484.00	\$8949.50
VE106 Groove-N-Go 220V	R000106220	140/200	N/A	8949.50

For tool rating capacity please reference publication 24.01.

VE106 GROOVING ROLLS *

Pipe Material	Part Number	Pipe Size Range inches DN	Purchase List Price Each Set †
Carbon Steel (Sch. 5 – 40)	R912106UA6	1¼ – 6/32 – 50 Upper	\$285.50
	R912106L03	1¼ – 3/32 – 80 Lower	799.50
Stainless Steel (Sch. 20 – 40)	R904106L06	4 – 6/100 – 150 Lower	799.50
Copper	RR02106006	2 – 6/50 – 150	1119.00
Lt. Wall Stainless Steel RX (Sch. 5S – 10S)	RX12106L06	1¼ – 6/32 – 150 Lower	884.50
EndSeal	RZ02106003	1¼ – 3/32 – 80	1169.50
	RZ04106006	4 – 6/100 – 150	1169.50

Rolls and roll sets for discontinued models may be purchased. Please contact Victaulic for details.

§ ROLLS CAN ONLY BE RENTED WITH A TOOL RENTAL. Contact Victaulic for details.

Any rental tool requiring extra rolls, in addition to standard rolls supplied, such as **RR (Copper)**, **RX (Lt. Wall Stainless Steel)**, **RP (PVC/Aluminum)**, **RZ (EndSeal)** will incur an additional rental charge per roll set.

† Upper and lower rolls (1 of each per set) can be sold separately. Contact Victaulic.

* Refer to How to Order at the end of this section.

NOTE: Items listed in shaded areas are non-cancellable and non-returnable.

Pipe Preparation Tools

VE206



VE206 portable roll grooving tool with a self-contained power drive provides capability of grooving 1¼ – 6¾/32 – 150 mm pipe, up to and including Schedule 40. The tool requires 110V, 15-amp power source. Tool is supplied complete with standard roll sets for steel 1¼” – 6¾/32 – 150 mm (4 – 6¾/100 – 150 mm rolls are installed).

Tool Model	Part Number	Tool Weight lb	Tool List Price
VE206 – 110V with Ridgid* 700 Power Drive	R000206MAS	244	\$13236.00
VE206 – without power drive unit	R000206MA1	220	9455.50

* Ridgid™ is a trademark of Ridgid, Inc. Victaulic is not associated with Ridgid, Inc.

Other compatible power drive units are available upon request.

For tool rating capacity please reference publication 24.01.

VE206 GROOVING ROLLS *

Pipe Material	Part Number	Pipe Size Range inches DN	Purchase List Price Each Set †
Carbon Steel (Sch. 5 – 40)	R912106UA6	1¼ – 6/32 – 50 Upper	\$285.50
	R912106L03	1¼ – 3/32 – 80 Lower	799.50
Stainless Steel (Sch. 20 – 40)	R904106L06	4 – 6/100 – 150 Lower	799.50
Copper	RR02106006	2 – 6/50 – 150	1119.00
Lt. Wall Stainless Steel RX (Sch. 5S – 10S)	RX12106L06	1¼ – 6/32 – 150 Lower	884.50
EndSeal	RZ02106003	1¼ – 3/32 – 80	1169.50
	RZ04106006	4 – 6/100 – 150	1169.50

Any tool requiring extra rolls, in addition to standard rolls supplied, such as **RR (Copper)**, **RX (Lt. Wall Stainless Steel)**, **RP (PVC/Aluminum)**, **RZ (EndSeal)** will incur an additional charge per roll set.

† Upper and lower rolls (1 of each per set) can be sold separately. Contact Victaulic.

* Refer to How to Order at the end of this section.

NOTE: Items listed in shaded areas are non-cancellable and non-returnable.

Pipe Preparation Tools

VE272SFS



The VE272SFS portable roll groover mounts easily to the Victaulic Ridgid 300° Power Drive. The VE272SFS is operated using a hand pump. A unique pivot arm design reduces handle effort. Roll changes are quick and easy. The tool is supplied complete with 2 – 12”/50 – 300 mm roll sets; 8 – 12”/200 – 300 mm rolls are installed.

NOTE: Optional ¾/20 mm and 1 – 1½”/25 – 40 mm grooving rolls available.

Requires a Ridgid 300 power drive.

Tool Model	Part Number	Tool Weight/ Shipping Weight lb	Rental Per Month	Tool List Price
VE272SFS	R000272SFS	184/250	\$2031.00	\$10801.00 [^]
Optional Stabilizer (8 – 12”/200 – 300 mm only)	R4002720FS	23	150.00	2936.00

† NOTE: When ordering tools that require a power drive, you must determine the type of drive to be used.

[^] For proper operation, a power drive and pipe stand are required. See Accessories for details.

For tool rating capacity please reference publication 24.01.

VE272SFS GROOVING ROLLS *

Pipe Material	Part Number	Pipe Size Range inches mm	Purchase List Price Each Set †
Carbon Steel (Sch. 5 – 40) Stainless Steel (Sch. 20 – 40)	R900268001	¾/20	\$4152.50
	R900268002	1 – 1½/25 – 40	3576.50
	R902272003	2 – 3½/50 – 90	2010.00
	R904272006	4 – 6/100 – 150	2148.00
	R908272012	8 – 12/200 – 300	2395.00
Copper	RR02272006	2 – 6/50 – 150	2489.50
	RR08272008	8/200	3497.50
Lt. Wall Stainless RX (Sch. 5S – 10S)	RX75268001	¾/20	4152.50
	RX01268002	1 – 1½/25 – 40	3576.50
	RX02272003	2 – 3½/50 – 90	2801.50
	RX04272006	4 – 6/100 – 150	3005.50
	RX08272012	8 – 12/200 – 300	3010.00
EndSeal	RZ02272003	2 – 3½/50 – 90	3269.00
	RZ04272006	4 – 6/100 – 150	3343.00
	RZ08272012	8 – 12/200 – 300	3477.50
PVC/Aluminum	RP02272003 [^]	2 – 3½/50 – 90	2161.00
	RP04272006	4 – 6/100 – 150	2464.50
	RP08272012	8/200	2611.50

NOTE: ROLLS CAN **ONLY** BE RENTED WITH A TOOL RENTAL. Contact Victaulic for details.

Any rental tool requiring extra rolls, in addition to standard rolls supplied, such as **RR (Copper)**, **RX (Lt. Wall Stainless Steel)**, **RP (PVC/Aluminum)**, **RZ (EndSeal)** will incur an additional rental charge per roll set.

† Upper and lower rolls (1 of each per set) can be sold separately. Contact Victaulic.

* Refer to How to Order at the end of this section.

+ Quoted on application. Contact Victaulic for pricing and availability.

NOTE: Items listed in shaded areas are non-cancellable and non-returnable.

Pipe Preparation Tools

Roll Grooving Tools – Shop Fabrication

NOTE: All shop models shipped set for 220 power, unless specified otherwise.

VE268 †



NOTE: All shop models shipped set for 220 power, unless specified otherwise. **3 phase requires tool power to be hard wired by a local certified electrician.**

Fully-motorized, semi-automatic, electro-hydraulic tool complete with safety guards, safety foot switch and power cord. The VE268 requires a 220/440V, 3 phase, 60 hertz power supply for operation and is equipped with a pipe stabilizer for 8 – 12”/200 – 300 mm nominal pipe sizes to prevent pipe sway. The tool is shipped fully assembled for standard grooving (2 – 12”/50 – 300 mm pipe) * (8 – 12”/200 – 300 mm rolls are installed, unless otherwise specified).

NOTE: Optional ¾ and 1 – 1½” grooving rolls available.

Request RP-268 for power requirements or visit the Victaulic web site.

† These tools are rated for 220 volt service. They cannot be used with 208 volt service. For individual amperage power requirements, refer to RP sheet supplied with tool. Each model may require different incoming power requirements. (If your service is 208 volts, a “Boost and Buck Transformer” may be required.)

Tool Model	Part Number	Tool Weight/ Shipping Weight lb	Rental Per Month	Tool List Price
VE268 – 220V	R000268VE0	735/766	\$4860.50	\$43867.00 [^]

[^] For proper operation, a pipe stand is required. See Accessories for details.

For tool rating capacity please reference publication 24.01.

VE268 GROOVING ROLLS *

Pipe Material	Part Number	Pipe Size Range inches mm	Purchase List Price Each Set †
Carbon Steel (Sch. 5 – 40) Stainless Steel (Sch. 20 – 40)	R900268001	¾/20	\$4152.50
	R900268002	1 – 1½/25 – 40	3576.50
	R902272003	2 – 3½/50 – 80	2010.00
	R904272006	4 – 6/100 – 150	2148.00
	R908272012	8 – 12/200 – 300 ‡	2395.00
Copper	RR02272006	2 – 6/50 – 150	2489.50
	RR08272008	8/200	3497.50
EndSeal	RZ02272003	2 – 3½/50 – 90	3269.00
	RZ04272006	4 – 6/100 – 150	3343.00
	RZ08272012	8 – 12/200 – 300	3477.50
Lt. Wall Stainless RX (Sch. 5S – 10S)	RX75268001	¾/20	4152.50
	RX01268002	1 – 1½/25 – 40	3576.50
	RX02272003	2 – 3½/50 – 80	2801.50
	RX04272006	4 – 6/100 – 150	3005.50
	RX08272012	8 – 12/200 – 300	3010.00
PVC/Aluminum	RP02272003 [^]	2 – 3½/50 – 90	2161.00
	RP04272006	4 – 6/100 – 150	2464.50
	RP08272012	8/200	2611.50

NOTE: ROLLS CAN **ONLY** BE RENTED WITH A TOOL RENTAL. Contact Victaulic for details.

Any rental tool requiring extra rolls, in addition to standard rolls supplied, such as **RR (Copper), RX (Lt. Wall Stainless Steel), RP (PVC/Aluminum), RZ (EndSeal)** will incur an additional rental charge per roll set.

† Upper and lower rolls (1 of each per set) can be sold separately. Contact Victaulic.

* Refer to How to Order at the end of this section.

NOTE: Items listed in shaded areas are non-cancellable and non-returnable.

[^] Lower roll only.

‡ Wall thickness capacity for 8 – 12” pipe is limited to Schedule 5 – 20.

Pipe Preparation Tools

Tool Accessories

VAPS112



Adjustable Pipe Stands are portable and self-standing units. Turnstile design allows pipe to be spun around for grooving of both pipe ends without dismounting pipe from stand. Unique trough design allows for rotational and forward/traverse movement. They are designed for direct use with roll grooving tools: VE272SFS, VE268, VE270FSD.

Capacities: 1 – 12"/25 – 300 mm IPS pipe †

Load Rating: 1075 lbs

Vertical Stroke: 14½"/368.3 mm for adjusting rod; 8½"/215.9 mm leg adjustment; 23"/584.2 mm total

Min. Pipe Height from Floor: 23"/584.2 mm on 12"/300 mm pipe; 21"/533.4 mm on 1"/25 mm pipe

Handle Effort Required to Raise 1800 lbs Load: 50 lbs Max.

Tool Model	Part Number	Tool Weight/ Shipping Weight lb	Rental Per Month	Tool List Price
VAPS 112	R000112PS0	190/220	\$1216.00	\$8770.00

† Indicates pipe size capacity. For wall thickness capacity and general tool ratings see separate Tool Rating Data in publication 24.01.

NOTE: Items listed in shaded areas are non-cancellable and non-returnable.

Pipe Preparation Tools

Hole Cutting Tools

VHCT900



Includes three-piece hole cutting tool (Base, drill motor and feed assembly), arbor assembly, coupon remover, 2 pilot drills with coupon retaining springs and operating instructions. Requires grounded 120/1/60 – 10 amp electrical supply. (220/1/60 – 10 amp no cost option). For sizes over 2 3/4"/70 mm or when speed control is needed for various materials, use an inline speed controller to reduce hole saw wear and improve performance.

Capacities: 1 – 4 1/2"/25 – 120 mm holes for 1/2 – 4"/15 – 100 mm *Mechanical-T*, Strapless Outlet connections.

Tool Model	Part Number	Tool Weight/ Shipping Weight lb	Rental Per Month	Tool List Price
VHCT900 – 110V	R000900HCT	36/61	\$626.00	\$8084.00

The 1" Arbor is optional. Hole saw blades available from Victaulic. See accessories below.

HCT908



The HCT908 Hole Cutting Tool is a one-piece tool designed to cut holes up to 4 1/2" carbon and stainless steel pipe. This allows for use of *Mechanical-T*, Strapless Outlet, Thermometer Outlet and Style 922 Outlet Tee. Requires 110 volt power supply to operate. For sizes over 2 3/4"/70 mm or when speed control is needed for various materials, use the supplied inline speed controller to reduce hole saw wear and improve performance.

Capacities: 1 – 2 3/4"/25 – 70 mm holes for 1/2 – 2 1/2"/15 – 76 mm *Mechanical-T* connections.

Tool Model	Part Number	Tool Weight/ Shipping Weight lb	Rental Per Month	Tool List Price
HCT908	R000908HCT	35/48	\$1085.50	\$4932.00

The 1" Arbor is optional. Hole saw blades available from Victaulic. See accessories below.

Pipe Preparation Tools

Vic-Press™ Tool

PFT510 Vic-Press® Tool



The Vic-Press tool for ASTM A-312 Schedule 10S stainless steel pipe arrives in 2 carrying cases and includes:

Case 1 – PFT510 Vic-Press tool, 2 18V lithium ion batteries, 120 VAC charger, wire brush, 1 paint stick and 1 tube of lubricant

Case 2 – ½"/DN15, ¾"/DN20, and 1"/DN25 jaws, 1½"/DN40 and 2"/DN50 ring-jaws, ring-jaw adapter jaw, insertion gauge set

WARNING: The PFT510 Vic-Press tool is designed for use only with Vic-Press Schedule 10S system couplings, valves and fittings. Do not attempt to install Schedule 5 Carbon Steel Press products with this tool. Failure to follow this instruction could cause system failure resulting in serious personal injury and property damage. Refer to TM-PFT510 for complete tool operating instructions.

Tool Model	Part Number	Tool Weight/ Shipping Weight lb #	Rental Per Month	Tool List Price
PFT510 Vic-Press™ Tool – 18V	R120510PFS	102	\$1762.50	\$13384.00

Weight is for tool and complete set of jaws.

Contact Victaulic for Replacement Gauge Kit (R000501SET) pricing and availability.

NOTE: Items listed in shaded areas are non-cancellable and non-returnable.

PFT510 JAWS AND ADAPTER

Description / Jaw Size inches	Part Number	List Price
PFT510 Jaw Adapter	RJAW510ADP	\$1136.50
½	RJAW510050	933.00
¾	RJAW510075	933.00
1	RJAW510100	933.00
1½	RJAW510150	3592.00
2	RJAW510200	3592.00

Pipe Preparation Tools

WARNING

- Always read and understand all operating and maintenance instructions before attempting to use any Victaulic pipe preparation tools. Victaulic tool operating and maintenance manuals can also be located at victaulic.com.
- Any Victaulic pipe preparation tools must be used by trained operators ONLY. Operators that use Victaulic Pipe Cut-Off Tools must be knowledgeable in sound welding and safety procedures.

Misuse of any equipment and lack of adherence to proper safety procedures may result in serious personal injury, property damage, and/or product damage.

How to Order

When ordering tools or tool parts, please include the following information:

A. PARTS ORDERS

1. Tool Model Number. Example: VE272SFS.
2. Tool Serial Number. The serial number can be found on the tool name plate.
3. Part Number and Description. Example: Part #09, R-201-261-0FS, Pump.
4. Where to send the part(s). Company Name, Address and Telephone Number
5. Attention: Person's Name
6. Purchase Order Number. Order parts from the nearest Victaulic Sales Office. Consult victaulic.com for locations.

B. TOOL ORDERS

1. Tool Model Number. Example: VE416FSD.
2. Tool Description. Example: VE416FSD Roll Grooving Tool.
3. Where to send the tool. Company Name, Address and Telephone Number
4. Attention: Person's Name
5. Purchase Order Number. Order tool from the nearest Victaulic Sales Office. Consult victaulic.com for locations.

C. TOOL RENTAL ORDER

1. A completed and signed tool rental agreement.
2. Purchase Order Number.
3. Tool Model Number. Example: VE272SFS
4. Tool Description. Example: VE272SFS Roll Grooving Tool.
5. Where to send the tool. Company Name, Address and Telephone
6. Attention: Person's Name. Order tool from the nearest Victaulic Sales Office. Consult victaulic.com for locations.

NOTES:

Aluminum pipe must consist of 6061-T4 or 6063-T4 alloys for roll grooving.

PVC grades that can be grooved – PVC Type I Grade I – PVC 1120; PVC Type I Grade II – PVC 1220; PVC Type II Grade I – PVC 2116.

Copper/nickel pipe - contact Victaulic for details.

Light weight stainless steel pipe (Sch. 10S and Sch. 5S) must be grooved using stainless Rx and RWX roll sets.

Note: Roll grooving tools and rolls shown on this chart will produce grooves in accordance with Victaulic Roll Groove Dimension charts and to ANSI/AWWA C-606 standards.

SPECIAL NOTE: All roll grooving tools will be stocked with standard rolls only. No substitution will be done. Optional rolls are available at an additional cost.

Pipe Preparation Tools

TERMS AND CONDITIONS OF TOOL RENTAL

1. Lessor rents to Lessee and Lessee leases from Lessor the tool(s) and accessories listed on the reverse side hereof, which are designed for use in the preparation of pipe to receive Victaulic products, hereinafter called the leased property; for the term specified, commencing when the leased property is delivered to carrier for delivery to Lessee.
2. **Rental Rate.** Lessee agrees to pay rent at the rates specified on this agreement. The rental shall be due and payable at the end of each month during the term of the lease. Terms of payment: net 30 days from date of invoice. If lease is terminated any time during the initial month, the rental shall be payable at the then current published monthly rental rate. If lease is terminated any time during a subsequent month, the rental will be prorated. (This agreement is valid for one (1) year, at the time of signing. It will be automatically renewed with price in effect at the time of renewal until the signee terminates the agreement.)
3. **On-Account Payment.** Lessee, on executing the agreement, has made an on-account payment to Lessor which shall be returned to Lessee upon termination of the lease, or applied to any open invoices on the Lessee's account, provided Lessee is not in default under any of the term of the lease and has returned leased property in good condition, less ordinary wear and tear.
4. **Freight.** Outbound: F.O.B. Shipping Point (Our Option) – Freight Collect. Return: Lessee shall pay all shipping charges for return of the leased property.
5. **Use.** All leased property is for the exclusive use of Lessee only, and may not be assigned, transferred, sublet or loaned to or used by any other party, without prior written consent of the Lessor.
6. **Ownership.** The property leased is and shall at all times remain the sole property of the Lessor, and Lessee shall have no right, title or interest therein except as expressly set forth in this Lease.
7. **Taxes.** Lessee shall pay all taxes, assessments, license and registration fees levied on the leased property while in the Lessee's possession and Lessee shall keep the leased property free and clear of all liens and encumbrances. Lessee shall pay all sales taxes invoiced by Victaulic Company unless the lessee provides the lessor with a valid sales tax exemption certificate for the state where the tool is delivered.
8. **Access.** Lessor shall at all times have free access to the leased property and to the premises on which located, for the purpose of examining the leased property.
9. **Return of Property.** Lessee shall return all leased property, properly crated, freight prepaid, and insured for its market value to Lessor at one of the locations indicated on the back cover. If Lessee fails to return the leased property upon termination, Lessee shall pay rent at the then current monthly rental rate until returned, and Lessor shall also have the right to remove the leased property from Lessee's premises, without recourse to any legal proceedings.
10. **Repairs and Servicing.** If leased property, excluding Tool Bits, becomes worn or unserviceable from normal recommended use, Lessor will supply replacement tools and/or parts, without cost, upon return of the leased property to Lessor.
11. **Damage or Loss.** If leased property is damaged by reason of other than normal recommended use, Lessee shall indemnify Lessor for the cost of repairs. If leased property is not returned to Lessor in accordance with the terms of this Agreement for any cause or reason whatsoever, including, without limiting the generality of the foregoing, loss, theft, damage, accident, neglect, abuse or destruction, by fire or otherwise, whether due to Lessee's fault or not, Lessee shall pay to Lessor as liquidated damages an amount to be determined by Lessor not to exceed the list price of all leased property, as published in the most current Victaulic price list for Pipe Preparation tools.
12. **Indemnity.** Lessee assumes full responsibility for the operation of the leased property and shall indemnify, protect, save and keep harmless the Lessor, its agents and servants from and against all losses, damages, penalties, claims, actions, suits, costs, expenses and disbursements, including legal expenses of whatsoever kind in nature imposed upon, incurred by, or asserted against the Lessor in any way relating to or arising out of this Lease or of the Lessee's delivery, possession, use, operation or return of the leased property. The indemnities contained in this paragraph shall continue in full force and effect, notwithstanding the termination of this Lease.
13. **Lessor's remedies on default.** If the Lessee, with regard to any item or items of property, fails to pay any rent or other amount herein provided when the same shall become due and payable, or if the Lessee, with regard to any item or items of leased property, fails to observe, keep or perform any other provisions of this lease required to be observed, kept, or performed by the Lessee, or if any execution or other writ or process shall be issued in any action or proceeding against the Lessee, whereby the said leased property may be taken, the Lessor shall have the right to exercise any one or more of the following remedies:
 - (a) To declare the entire amount of rent hereunder immediately due and payable as to any or all items of leased property, without notice or demand to the Lessee.
 - (b) To sue for and recover all rents, and other payments, then accrued or thereafter accruing, with respect to any or all items of leased property.
 - (c) To take possession of any or all items of leased property without demand or notice, wherever the same shall be located, without any court order or other process of law. The Lessee hereby waives any and all damage occasioned by such taking of possession. Any said taking of possession shall not constitute a termination of this lease as to any or all items of leased property unless the Lessor expressly so notifies the Lessee in writing.
 - (d) To terminate this lease as to any or all items of leased property.
 - (e) To pursue any other remedy at law or in equity.Notwithstanding any such repossession or any other action, which the Lessor may take, the Lessee shall be and remain liable for the full performance of all obligations on its part to be performed under this lease; provided however, that if the Lessor is able to obtain any monies for said leased property from re-rental or sale thereof, which the Lessor specifically is not in any manner obligated to do, said monies, less expenses, shall be credited to the last payments of the Lessee's obligation. Waiver of any default herein is not a waiver of any subsequent default. All such remedies are cumulative and may be exercised concurrently or separately.
14. **Bankruptcy.** Neither this lease nor any interest therein is assignable or transferable by operation of law. If any proceeding under the Bankruptcy Act, as amended, is commenced by or against the Lessee, or if the Lessee is adjudged insolvent, or if the Lessee makes any assignment for the benefit of his creditors, or if a writ of attachment or execution is levied on any item or items of leased property and is not released or satisfied within 10 days thereafter, or if a receiver is appointed in any proceeding or action, to which the Lessee is a party, with authority to take possession or control of any item or items of the leased property, the Lessor shall have any may exercise any one or more of the remedies set forth in Paragraph 13 hereof; and this lease shall, at the option of the Lessor, without notice immediately terminate and shall not be treated as an asset of the Lessee after the exercise of said option.
15. **Concurrent Remedies:** The rights and remedies provided in this lease for the benefit of the Lessor shall be cumulative and shall not be exclusive but in addition to any other remedies to which the Lessor may be entitled. the Lessee waives trial by jury in any action or proceeding arising hereunder.
16. **Lessor's expenses:** The Lessee shall pay the Lessor all costs and expenses, including attorney's fees, incurred by the Lessor in exercising any of its rights or remedies hereunder or enforcing any of the terms, conditions, or provisions hereof.
17. **Binding Effect of Lease.** This lease agreement shall inure to the benefit of and be binding upon the parties hereto and their respective heirs, executors, administrators, personal or legal representatives, successors and assigns.
18. **Applicable Law and Severability.** This lease shall be governed by and construed under the laws of the State of Pennsylvania. If any provision herein is invalid, it shall be considered deleted from this lease, and shall not invalidate the remaining provisions of this lease.

Pipe Preparation Tools

TERMS AND CONDITIONS OF TOOL SALE

Controlling Provisions: These terms and conditions shall control with respect to any purchase order or sale of Victaulic products.

No alteration, modification or waiver of these terms and conditions whether on Customer's purchase order or otherwise shall be valid unless the alteration, modification or waive is specifically accepted in writing by an authorized representative of Victaulic.

Prices, Designs and Terms and Conditions of Sale are subject to change without notice.

Minimum Order: \$500.00 net for any single order.

Terms of Payment: As stated on invoice. Maximum permissible interest rate thereafter.

Shipping Terms: F.O.B. shipping point (our option), freight prepaid and allowed on single orders having a net price value of \$12500 and over, for shipment at one time to one destination within the continental United States, excluding Alaska, Hawaii, Puerto Rico and U.S. possessions.

Shipments beyond the borders of the United States are prepaid and chargeable or collectable to final destination.

The most economical routing to recognized delivery points will be used, at our discretion. If special routing is desired, orders should so state.

Orders are accepted subject to approval of our General Office and Credit Department at Easton, Pennsylvania, and contingent upon **acts of God, war, civil disturbance, strikes, labor difficulties, delays of carriers, inability to obtain materials, accidents or any other cause beyond our control.**

Shipping dates are estimated as closely as possible. We use our best efforts to ship within the time estimated, but cannot guarantee to do so. In the event production or shipment is delayed, we reserve the privilege of changing shipping estimate. **Under no circumstances shall Victaulic be liable for damages of any kind, including but not limited to incidental or consequential damages for lost profits or lost sales or liquidated damages, directly or indirectly arising from delays or failure to meet shipping dates.**

Orders, when accepted, cannot be countermanded without our written consent. No material will be taken back without our written consent. Orders for non-standard material may not be cancelled nor will we accept return of such material for credit.

All material is carefully examined, counted and packed by experienced employees. Claims for corrections must be made within 10 days of receipt of goods. Our responsibility ceases when goods are delivered to carrier in good condition and its receipt obtained. Carriers are responsible for goods lost, damaged or delayed in transit. For your own protection, have transportation company's agent verify damages, shortages or delays and note them on freight bill over his signature.

Weights: All weights are approximate shipping weights and subject to change without notice.

Victaulic Company maintains a continual policy of product improvement and, therefore, reserves the right to change product specifications, designs, and standard equipment without notice and without incurring obligation.

WARRANTY

Standard product warranty applies. See Inside Back Cover.

NOTE: Reconditioned tools shall be warranted 30 days from date of purchase.

1.0 TERMS AND CONDITIONS OF SALE

CONTROLLING PROVISIONS: These terms and conditions shall control with respect to any purchase order or sale of Victaulic products.

No alteration, modification or waiver of these terms and conditions whether on Customer's purchase order or otherwise shall be valid unless the alteration, modification or waiver is specifically accepted in writing by an authorized representative of Victaulic.

Prices, Designs and Terms and Conditions of Sale are subject to change without notice.

TERMS OF PAYMENT: As stated on invoice. Maximum legal interest rate charged thereafter.

MINIMUM INVOICE CHARGES: \$500 net for any single order.

SHIPPING TERMS: F.O.B. shipping point (our option) freight prepaid and allowed on single orders (excluding No. 26/No. W26 Outlet Fittings and Series 387 Inline/ Series 388 End Suction Pump Skids) having a net price value of \$12500 and over for shipment at one time to one destination into distributor stock or direct ship to a project, as determined by Victaulic within the continental United States, excluding Alaska, Hawaii, Puerto Rico and U.S. possessions.

Shipping and handling charges on orders less than net price value of \$12500, F.O.B. shipping point (our option) will be paid by the customer. The most economical routing to recognized delivery points will be used, at our discretion. The cost of any special routing, packaging or handling that has been requested by the customer, and is a deviation to our normal handling methods, will be added to the order and paid by the customer.

Shipments beyond the borders of the United States are prepaid and chargeable or collectable to final destination.

Orders are accepted subject to approval of our General Office and Credit Department at Easton, Pennsylvania, and contingent upon **acts of God, war, civil disturbance, strikes, labor difficulties, delays of carriers, inability to obtain materials, accidents or any other cause beyond our control.**

Victaulic will endeavor to ship by the scheduled delivery date, but reserves the right to ship within a reasonable period thereafter. **Under no circumstances shall Victaulic be liable for damages of any kind, including but not limited to incidental or consequential damages for lost profits or lost sales or liquidated damages, directly or indirectly arising from delays or failure to meet shipping dates.**

Orders, when accepted, cannot be cancelled without our written consent. No material will be taken back without our written consent. **Orders for non-standard (i.e. non-cancellable/non-returnable) material may not be cancelled nor will Victaulic accept return of such material for credit. Victaulic reserves the right to change the designation of products from standard to non-standard and vice versa. This may be done at any time without notice, and without incurring obligation. For further information contact Victaulic.**

All material is carefully examined, counted and packed by experienced employees. Claims for corrections must be made within 10 days of receipt of goods to the Customer Care center in Easton, PA (1-800-PICK VIC). We prove our count by weight. Claims for shortages are subject to that test. Our responsibility ceases when goods are delivered to carrier in good condition and its receipt obtained. Carriers are responsible for goods lost, damaged or delayed in transit. For your own protection, have transportation company's agent verify damages, shortages or delays and note them on freight bill over his signature.

WEIGHTS: All weights are approximate shipping weights and subject to change without notice.

Victaulic maintains a continual policy of product improvement and, therefore, reserves the right to change product specifications, designs, and standard equipment without notice and without incurring obligation.

2.0 LIMITED WARRANTY

What is Covered: This warranty covers any defects in materials or workmanship in products sold by Victaulic occurring under normal conditions of use and service with the exceptions stated below.

How Long Coverage Lasts: This warranty runs for one year from the date of delivery to the original buyer.

What is Not Covered: This warranty shall not apply to any product which has been subject to misuse, negligence, or accident (such as, without limitation, exposure to incompatible chemical or corrosive agents including microbial corrosion), which has been repaired or altered in any manner outside of Victaulic's factory, or which has been used in a manner contrary to Victaulic's instructions or recommendations. This warranty shall not apply to any Victaulic products utilizing proprietary grooves (such as, but not limited to, the Victaulic AGSTM, IGSTM, or PGS-300TM grooves) which have been used on pipe that has been grooved to ANSI/ AWWA C-606 standards or which was grooved using tools not supplied by Victaulic or its licensees. Victaulic shall not be responsible for design errors due to inaccurate or incomplete information supplied by Buyer or its representatives.

What Victaulic will do: Victaulic will repair or replace, at its option, any product that proves to be defective in materials or workmanship following an examination by Victaulic that shows to its satisfaction the product was defective in materials or workmanship.

THIS LIMITED WARRANTY IS EXCLUSIVE AND MADE EXPRESSLY IN LIEU OF ANY OTHER WARRANTIES, EXPRESS OR IMPLIED, INCLUDING ANY IMPLIED WARRANTY OF MERCHANTABILITY OR FITNESS FOR A PARTICULAR PURPOSE. THE BUYER'S SOLE AND EXCLUSIVE REMEDY SHALL BE FOR THE REPAIR OR REPLACEMENT OF DEFECTIVE PRODUCTS AS PROVIDED HEREIN. THE BUYER AGREES THAT NO OTHER REMEDY (INCLUDING, BUT NOT LIMITED TO, INCIDENTAL OR CONSEQUENTIAL DAMAGES FOR LOST PROFITS, LOST SALES, INJURY TO PERSON OR PROPERTY OR ANY OTHER INCIDENTAL OR CONSEQUENTIAL LOSS) SHALL BE AVAILABLE.

Victaulic neither assumes nor authorizes any person to assume for it any other liability in connection with the sale of products.

Items purchased by Victaulic and resold will have the original equipment manufacturer's warranty extended to Victaulic customers.

How to Get Service: Contact Victaulic at 610-559-3300 within one year after delivery to the original buyer to arrange for an examination of the product. You will be asked to ship the product to Victaulic's factory, postage and transportation charges prepaid, for examination. There is no charge for examination. Victaulic will examine the product and contact you within a reasonable time regarding the results of that examination and to arrange for repair or replacement of any product determined to be defective in materials or workmanship.

COUPLINGS, FITTINGS, VALVES AND ACCESSORIES

FIRE PROTECTION PRICE LIST



U.S./World Headquarters

4901 Kesslersville Road
Easton, PA 18040 USA

victauliclocations.com

EMEA

Prijkelstraat 36
9810 Nazareth, Belgium

Asia Pacific

Unit 808, Building B
Hongwell International Plaza
No.1602 West Zhongshan Road
Shanghai, China 200235



PL2021-FP 16838 REV A 04/2021

Victaulic and all other Victaulic marks are the trademarks or registered trademarks of Victaulic Company, and/or its affiliated entities, in the U.S. and/or other countries. All other trademarks listed herein are the property of their respective holders, in the U.S. and/or other countries. The terms "Patented" or "Patent Pending" refer to design or utility patents or patent applications for articles and/or methods of use in the United States and/or other countries.

© 2021 VICTAULIC COMPANY. ALL RIGHTS RESERVED.

