

SAFETY INSTRUCTIONS

WARNING

1. 120 Volts may cause serious injury from electric shock. Disconnect electrical power before starting installation or servicing. Leave power disconnected until installation/service is completed.
2. Sharp edges may cause serious injury from cuts. Use care when cutting plenum openings and handling duct work.
3. Dropping may cause personal injury or equipment damage. Handle with care and follow installation instructions.

CAUTION

1. Read all instructions before beginning installation.
2. Improper installation may cause property damage or injury. Installation, service, and maintenance must be performed by a qualified service technician.
3. Do not use in pool applications. Pool chemicals can damage the dehumidifier.
4. Do not use solvents or cleaners on or near the circuit board. Chemicals can damage circuit board components.
5. Wait 24 hours before running the unit if it was not shipped or stored in the upright position

TABLE OF CONTENTS

Safety Instructions	1	Air Cycling	5
Specifications	2	System Set-Up, Check & Start-Up	6
Set Up Dehumidifier for Installation	2	Remote Control – Crawl Space	6
Packaging Content	2	Ventilation / Air Cycling	7
Duct Collars	2	System Check	7
Location Considerations	3	Crawl Space Using the Dehumidifier Control	8
Installation	3	Crawl Space Remote Control Using Model 76	8
Leveling	3	Start-Up	8
Ductwork Installation	3	Troubleshooting	9
Drain Tubing and Condensate Pump Installation	4	Table 1 – Diagnostic Codes	9
Model 76 – Crawl Space Control and Wiring	5	Table 2 – Troubleshooting Guide	10
		Service Parts	11

READ AND SAVE THESE INSTRUCTIONS

SPECIFICATIONS

	Model 1820
Weight	56 lbs.
Capacity: AHAM DH-1-2008 80°F, 60% RH Conditions	70 pints per day @ 200 CFM
Power: 115 VAC, Single Phase, 60Hz	5.8 Amps operating current
Dehumidifier Inlet Air Conditions	Dehumidification: 50°F – 104°F, 40°F dew point minimum Ventilation: 40°F – 140°F, 0%RH – 99%RH (non-condensing)
Filter	MERV 8, washable
Airflow	200 CFM

SET UP DEHUMIDIFIER FOR INSTALLATION

⚠ IMPORTANT: Cut the strap securing the compressor shipping support bracket and remove the strap and shipping bracket. See **Figure 1**.

PACKAGING CONTENT

1. Dehumidifier
2. Inlet/Outlet Collars
3. Literature
 - a. Installation Instructions
 - b. Owner's Manual
4. Parts Bag
 - a. #10 x 1/2 Screws (9)
 - b. Threaded Barbed Fitting for Drain Connections
 - c. Torx Bit
5. 10 foot, 3/4" Drain Tube

FIGURE 1 – Remove Shipping Bracket

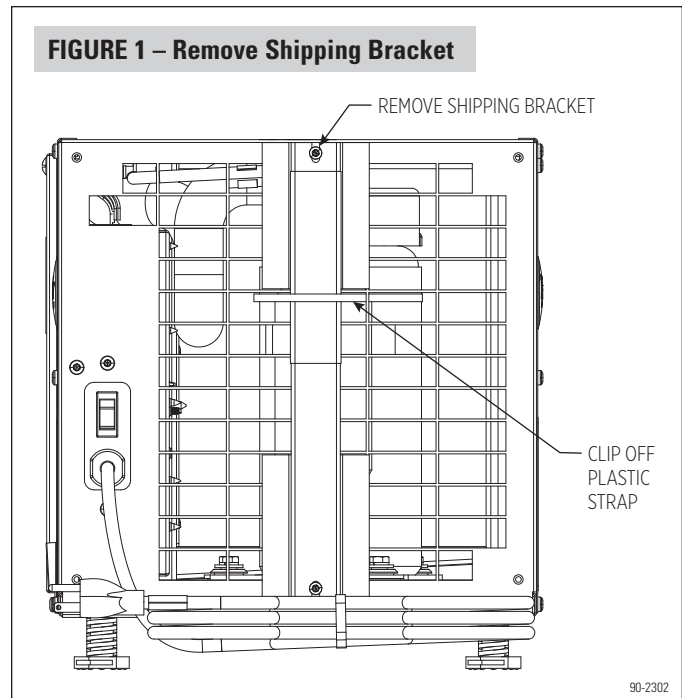

DUCT COLLARS

Use the screws in the parts bag to attach the duct collars to the inlet and outlet of the dehumidifier. See **Figure 2**.

FIGURE 2 – Install Duct Collars

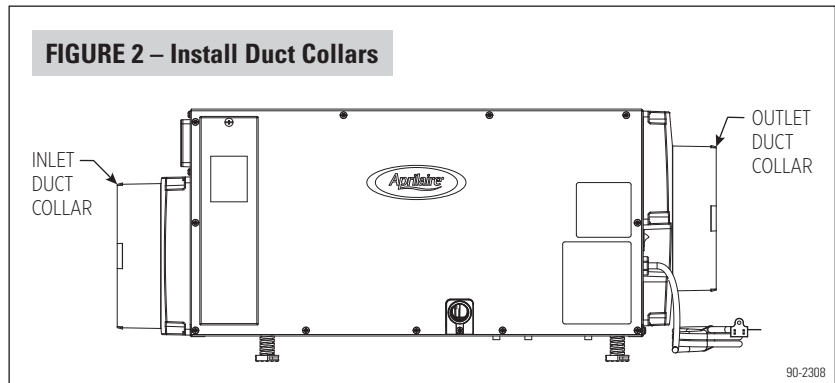

LOCATION CONSIDERATIONS

- Allow sufficient clearance for filter removal and to prevent airflow obstruction
- Electrical service access will require the removal of the side panel shown. Allow sufficient space for service on this side of the unit.

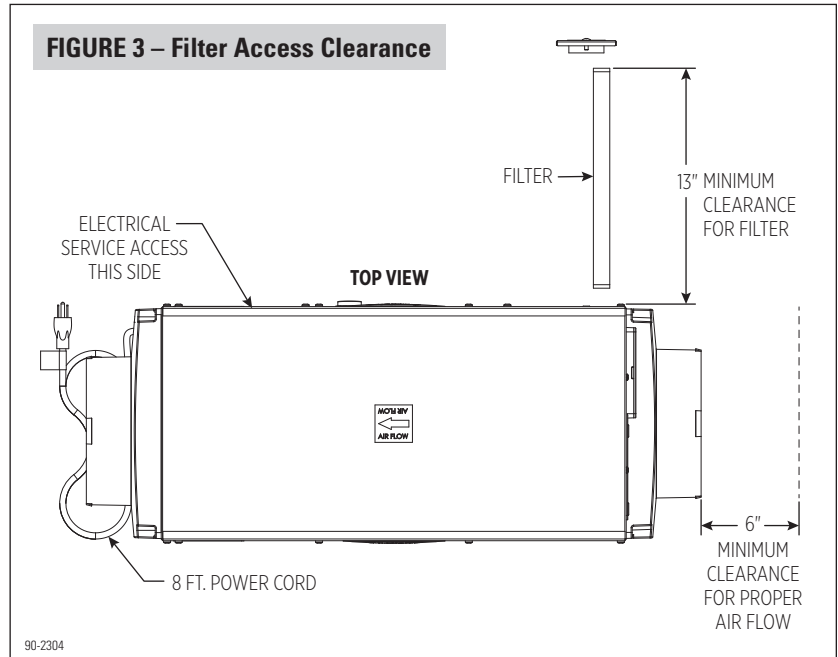

INSTALLATION

LEVELING

The feet can be adjusted to level the unit, and if required, to accommodate drain fittings and a secondary condensate pan. **Leveling is required** to ensure proper drainage from the dehumidifier. See **Figure 4**.

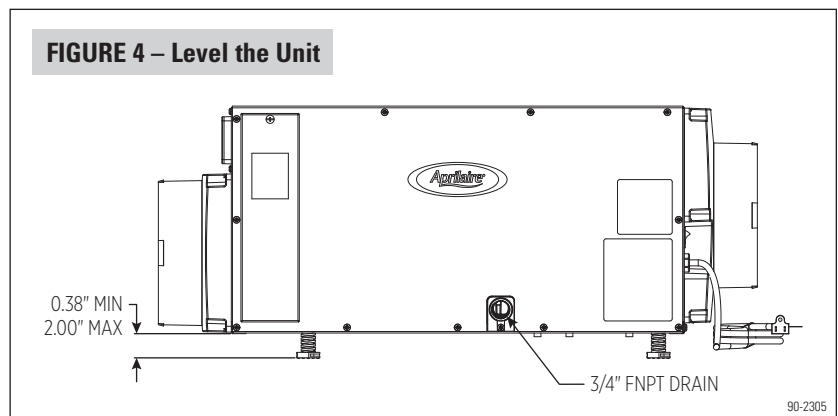

DUCTWORK INSTALLATION

Adding 5-10 feet of insulated ductwork to the inlet and outlet of the dehumidifier will ensure dehumidified air is circulated throughout the crawl space and will reduce the noise level of the dehumidifier. Point the inlet and outlet ducts in opposite directions to minimize recirculation of dehumidified air.

- Maximum recommended total duct length is 100 feet.
- To avoid pulling in dirt and other particles, do not lay intake duct on the floor of the crawl space.

NOTE: This dehumidifier is designed for crawl space and stand-alone applications only. **Do not** duct to HVAC system.

INSTALLATION (CONTINUED)

DRAIN TUBING AND CONDENSATE PUMP INSTALLATION

The drain outlet on the dehumidifier can be plumbed directly to a condensate pump (see **Figure 5**) using the provided 3/4" MNPT x 3/4" hose barb fitting and 3/4" clear PVC tubing. Always maintain a constant downward slope from the dehumidifier to the condensate pump. **NOTE:** PTFE thread seal tape is recommended for the threaded connection. **Hand tighten only.** The 4856 condensate pump is capable of lifting water up to 22 feet. The dehumidifier can be elevated (while remaining level) to increase downward slope for proper draining. Wire the float switch terminals to the normally closed contacts on the condensate pump (see **Figure 6**).

FIGURE 5 – Drain and Condensate Pump Installation

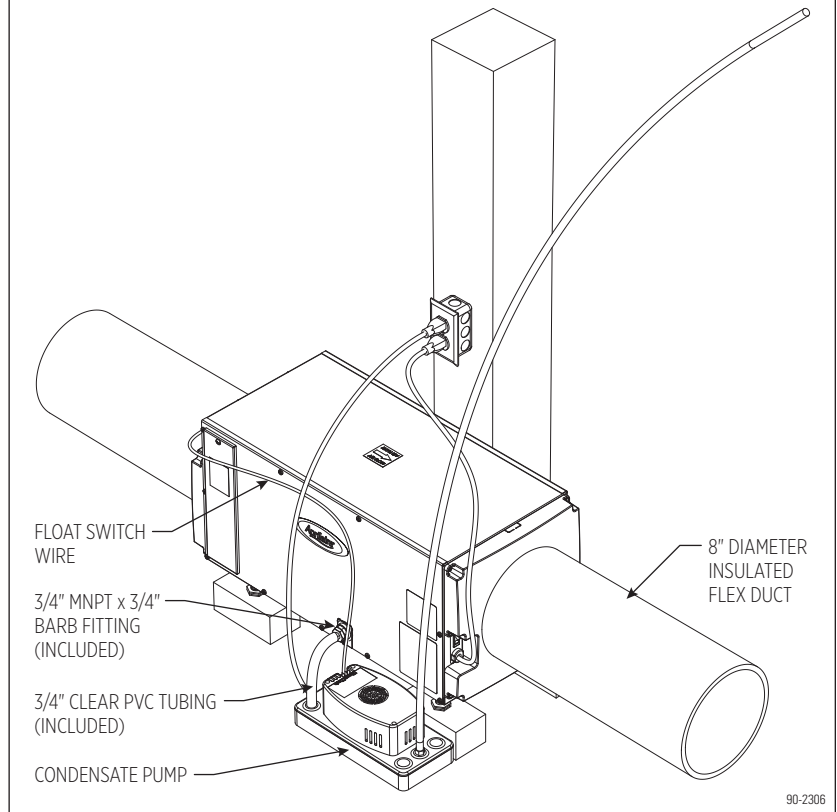
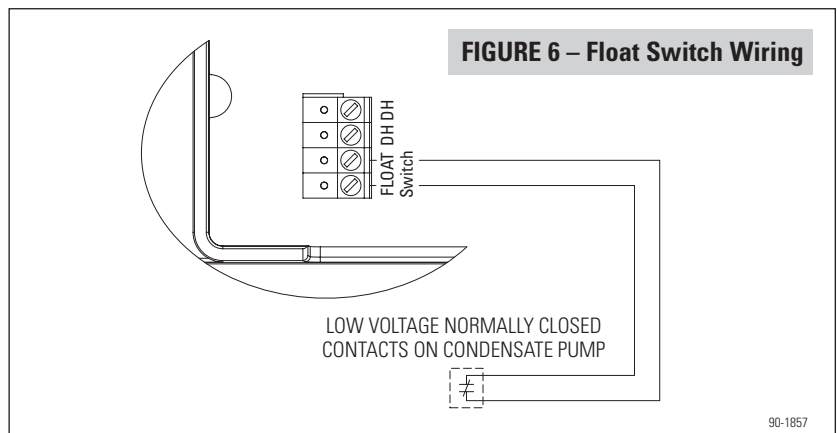

FIGURE 6 – Float Switch Wiring



MODEL 76 – CRAWL SPACE CONTROL AND WIRING

NOTE: Use 18-22 AWG wire for control wiring.

Used as a crawl space control (or remote control), the Model 76 is mounted in the living space while the dehumidifier is located in the crawl space. When the dehumidifier is powered, the display on the dehumidifier control will show "REMOTE" to indicate that a remote control is being used. The RH shown on the Model 76 is the RH measured at the dehumidifier.

NOTE: Air Cycling is not an option when using a Model 76 as a remote control.

FIGURE 7 – Model 76 Crawl Space/Sealed Attic (Remote) Wiring

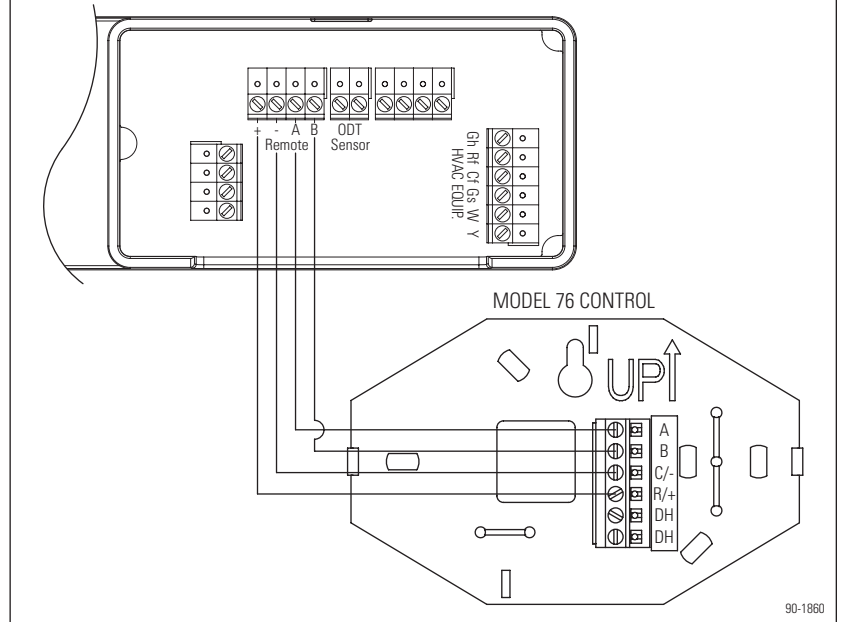

AIR CYCLING

The dehumidifier has an optional ventilation feature that can be used to circulate air through the dehumidifier, to promote uniform humidity levels throughout the space. When this feature is enabled, the dehumidifier fan can be set to run from 0 minutes (no air cycling) to 60 minutes (continuous) per hour. See **VENTILATION / AIR CYCLING** in the **SYSTEM SET-UP, CHECK & START-UP** section on page 7.

NOTE: The on-board control must be used when Air Cycling.

SYSTEM SET-UP, CHECK & START-UP

If using a Model 76 Remote Control and/or the Air Cycling feature, proceed to **Step 1** below. If not using either feature, proceed to **SYSTEM CHECK** on page 7.

1. Check all wiring.
2. Make sure the wire access cover has been snapped back onto the on-board control.
3. Plug unit in and turn power switch to ON. The power switch is located on the dehumidifier outlet next to the power cord.
4. The on-board control screen should display OFF.

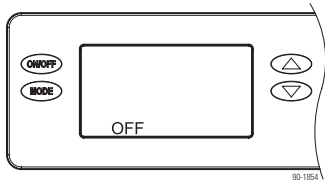

NOTE: If the display backlight is not on, the first button press (any button) will only turn on the backlight. Press the button a second time to achieve function.

5. Hold the MODE button on the on-board control for 3 seconds to enter the Installer Set-up Menu.
6. Navigate through the following screens to set up the dehumidifier for the installed application.

Use the UP or DOWN arrows to select items and use MODE to switch to the next set-up option. To exit installer set-up, all options must be scrolled through using the MODE button.

7. After the installer set up options have been completed, DONE will blink for 3 seconds and the control will return to the OFF screen.

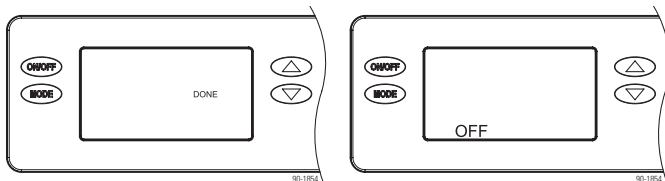

REMOTE CONTROL – CRAWL SPACE

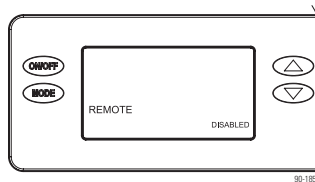

If not installing in a crawl space with Model 76 remote control, press MODE to go to VENT screen selections

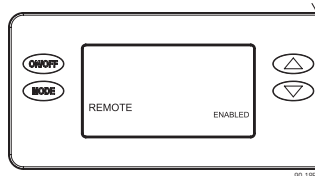

If installing in a crawl space with remote control, Enable and press MODE. The installer set-up is complete, proceed to **SYSTEM CHECK** on page 7.

NOTE: Air Cycling is not an option when Remote is enabled.

SYSTEM SET-UP, CHECK & START-UP (CONTINUED)

VENTILATION / AIR CYCLING

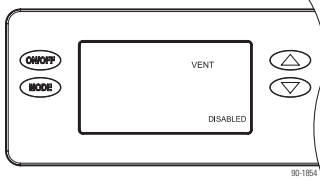

If not using the dehumidifier to periodically cycle air in the crawl space, press MODE to go to ZONE screen selections.

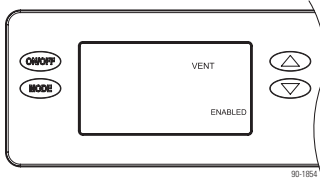

If using the dehumidifier for air cycling, Enable and press MODE.

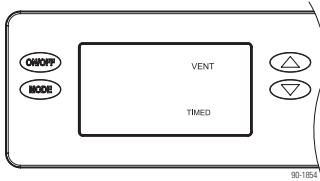

Press MODE at the VENT TIMED screen to go to ventilation time selection screen.

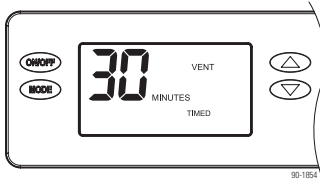

Press the UP or DOWN arrows to adjust the ventilation time per hour from 0 to 60 minutes. After selecting time, press MODE. Press MODE through the ZONE, EXTERNAL, DEH w/AC, and RH offset screens. DONE will be displayed on the screen and Installer Set-up is complete. Proceed to **SYSTEM CHECK** on page 7.

SYSTEM CHECK

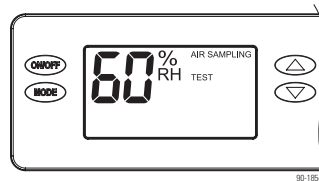

Press and hold the ON/OFF button and MODE buttons for 3 seconds. The measured humidity, AIR SAMPLING and TEST will show on the display.

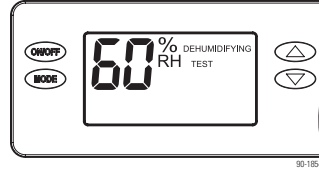

After three (3) minutes the dehumidifier compressor will turn on and DEHUMIDIFYING will replace AIR SAMPLING on the control screen.

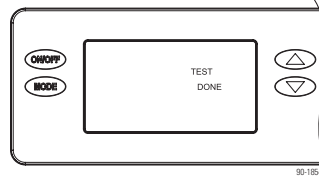

After one minute of compressor operation, all outputs will turn off and DONE will blink for 3 seconds and then return to the OFF screen.

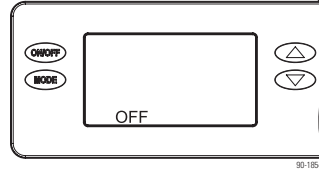

SYSTEM SET-UP, CHECK & START-UP (CONTINUED)

CRAWL SPACE USING THE DEHUMIDIFIER CONTROL

1. Press the ON/OFF button to turn the dehumidifier control ON. The display will show the current setting, and the dehumidifier blower and HVAC blower (if wired to the HVAC system) will turn on to start sampling the air.

The setting will be replaced by the measured humidity and "AIR SAMPLING" will show on the display.

2. Use the UP or DOWN button to adjust the humidity setting as desired. The recommended initial setting is 59%.
3. After three (3) minutes of sampling, the measured humidity will be compared to the setting:
 - a. If the humidity is above the setting, the dehumidifier compressor turns on and "AIR SAMPLING" will be replaced by "DEHUMIDIFYING". The compressor remains on until the measured humidity falls 3% RH below the setting.
 - b. If the measured humidity is below the setting, the blowers turn off and the display returns to showing the RH setting.
4. The dehumidifier will sample again every 60 minutes, or at any time if the humidity setting is lowered.

CRAWL SPACE REMOTE CONTROL USING MODEL 76

1. Press the ON/OFF button to turn the dehumidifier control ON. "REMOTE" will show on the display to indicate that a remote control is wired to the dehumidifier.
2. At the Model 76, press the ON button; the Model 76 will display the RH measured at the dehumidifier, and the dehumidifier blower will turn on to start sampling the air.
3. Use the UP or DOWN button on the Model 76 to adjust the dryness level as desired. The dryness levels are from 1 to 7, with 1 being least dry and 7 being most dry; the recommended initial setting is 3.
4. After three (3) minutes of sampling, the measured humidity will be compared to the setting:
 - a. If the humidity is above the setting, the dehumidifier compressor turns on and "ON" flashes on the Model 76 display.
 - b. If the measured humidity is below the setting, the dehumidifier blower turns off.
5. The dehumidifier will sample again every 60 minutes, or at any time if the dryness level is increased.

START-UP

Your dehumidifier is equipped with two features that protect against unwanted energy consumption. Defrost is a normal operating mode that helps to prevent significant ice formation on the refrigeration system coil. The dehumidifier display will show "DEFROSTING" when operating in this mode. This mode can occur when there is not enough air moving through the dehumidifier or if the temperature and/or humidity of the incoming air is too low. The second protection feature is the E8 code. E8 on the dehumidifier display indicates that the air entering the dehumidifier is below 50°F or above 104°F, or the dew point of the incoming air is below 40°F. There would be a significant reduction in dehumidifier efficiency if the dehumidifier operated outside of these conditions. Low dew point conditions can be seen in some basements or crawl spaces and usually occur in the Winter and Spring months. The dehumidifier continues to monitor the incoming air and when the conditions are within the operating range, E8 will be removed from the display and dehumidification will begin as needed.

TROUBLESHOOTING

Technical Support is available Monday through Friday, 7:00 a.m. to 5:00 p.m. CST, at (800) 334-6011. Use the guides on the following pages to identify and correct system faults. Contact Technical Support before replacing the unit or any components and for additional troubleshooting.

DIAGNOSTIC CODES

When an error occurs, the Diagnostic Code along with SERVICE REQUIRED will be displayed on the control screen.

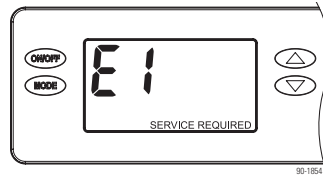

TABLE 1 – Diagnostic Codes			
Diagnostic Code	Failure Mode	Action	Reset
E1	Internal Humidity or Temperature Sensor Open or Shorted	<ol style="list-style-type: none"> 1. Check the connection between the sensor board and control board. 2. If connection okay, replace sensor board, Part No. 5460. 	Cycle Power
E2	High Refrigeration Pressure	<ol style="list-style-type: none"> 1. Verify that the fan works and there is no blocked or restricted ductwork. 2. If the fault persists, call Technical Support. 	Cycle Power
E3	Model 76 Remote Control Communication Loss	<ol style="list-style-type: none"> 1. Check connections between Model 76 and dehumidifier control board. Terminals should be fully inserted and secured in the control board and Model 76 control terminals. 2. If connections are correct and secure, turn off the dehumidifier and remove the Model 76. Use a short section of 4-wire cable to reconnect the Model 76 to the control board. Turn the dehumidifier back on and increase the dryness level setting on the Model 76. If the dehumidifier turns on, the problem is with the wiring between the dehumidifier and control. 3. If the dehumidifier does not turn on, call Technical Support. 	Self-Correcting
E4	Insufficient Capacity	<ol style="list-style-type: none"> 1. Check the frost sensor connection at the power board. Terminal should be fully seated on the power board pins. 2. Remove the side access panel and verify that the sensor is secured to the suction line. 3. If the sensor is connected and secured to the refrigeration line proceed to the next step. 4. Reset the fault by cycling power to the dehumidifier. 5. Turn the humidity setting down (below room/home humidity level) to make a dehumidification call. 6. Allow the fan and compressor to run for approximately 10-15 minutes and then enter diagnostic test mode by simultaneously pressing the UP ARROW and MODE buttons for 3 seconds. The LCD will display the temperature measured by the internal sensor while also displaying AIR SAMPLING and ON, the humidity measured by the internal sensor while also displaying %RH and ON, and the frost sensor temperature while also displaying ON. Scroll through these values and by using the UP/DOWN arrow buttons. 7. Record values and call Technical Support. 	Cycle Power
E5	High Temperature Thermistor Failure	<ol style="list-style-type: none"> 1. Check the high temperature sensor connection at the power board. Terminal should be fully seated on the power board pins. 2. Remove the side access panel and verify the sensor is not damaged and connected to the refrigeration line coming from the compressor. 3. If the sensor is connected and secured to the refrigeration line, contact Technical Support. 	Cycle Power
E6	Low Temperature Thermistor Failure	<ol style="list-style-type: none"> 1. Check the low temperature sensor connection at the power board. 2. Remove the side access panel and verify the sensor is not damaged and connected to the suction line. 3. If the sensor is connected and secured to the refrigeration line, contact Technical Support. 	Cycle Power
E7	Float Switch Open	<ol style="list-style-type: none"> 1. Empty the condensate pan. 2. Check the float switch connection at the control board. 3. If not using a float switch, verify jumper is between float switch terminals on dehumidifier control board. 4. If the problem persists, replace the float switch. 	Self-Correcting
E8	Inlet Air Temperature Out of Range 50°F – 104°F or dew point below 40°F	<ol style="list-style-type: none"> 1. Verify all ductwork is properly sealed. 2. If no signs of leak points, contact Technical Support. 	Self-Correcting

TROUBLESHOOTING (CONTINUED)

TABLE 2 – Troubleshooting Guide

Symptom	Possible Reason	Troubleshooting Procedure
Dehumidifier does not turn on/run.	No power to unit.	<ul style="list-style-type: none"> • Check that the dehumidifier is plugged in. • Check that the power switch is turned ON. • Check that the control is turned ON. • Check that the circuit breaker has not tripped.
Dehumidifier blower is running but with little or no airflow.	Pressure drop across dehumidifier is higher than 0.4" w.c.	<ul style="list-style-type: none"> • Check dehumidifier air filter and wash or replace. • Check for blocked duct work and clear.
Dehumidifier blower is running but compressor is not.	Float switch open.	<ul style="list-style-type: none"> • If float switch installed, check connections at control board and empty condensate pan. • If no float switch installed check that the jumper is installed at the float switch terminals on the control board.
	Coil frosting.	<ul style="list-style-type: none"> • Lack of or reduced airflow. Check dehumidifier air filter and wash or replace. • Check for blocked duct work. • Inlet air conditions below 60°F. Increase the humidity setting.
	Inlet air temperature is outside of the 50°F – 104°F range or the dew point is below 40°F and there is a demand for dehumidification.	<ul style="list-style-type: none"> • Verify all ductwork is properly sealed.
Dehumidifier is not draining properly.	Drain line blocked or unit not level.	<ul style="list-style-type: none"> • Verify that the unit is level. • Check the drain line blockages and for a continuous downward slope.
Dehumidifier is producing hot air.	Normal function.	<ul style="list-style-type: none"> • Air is reheated across the condenser coil, resulting in a temperature rise between inlet and outlet, this is normal.

SERVICE PARTS

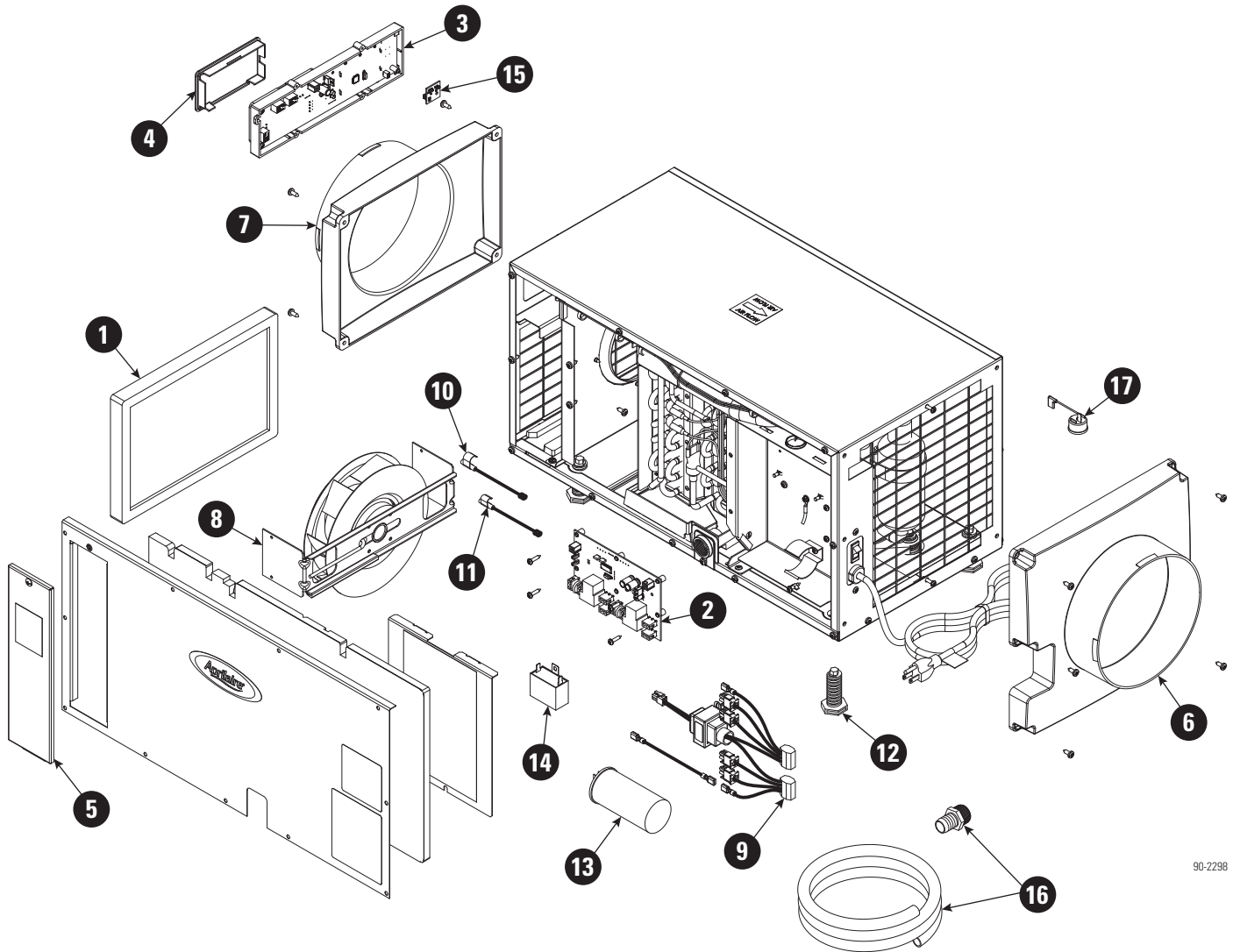

90-2298

No.	Part Description	Part No.
1	Filter, 8" x 11.75" x 1" EZK	5695
2	Internal Control Board, Deh	5444
3	User Interface Assembly, Deh	5445
4	Wiring Access Door, AA Deh	5446
5	Door, Filter Access, AA Deh	5696
6	Outlet Duct Panel, Deh	5698
7	Inlet Duct Panel, AA Deh	5699
8	Fan with 6MFD Capacitor	5694
9	Wire Harness, Power, Deh	5454
10	Sensor, Low Temperature, Deh	5455

No.	Part Description	Part No.
11	Sensor, High Temperature, Deh	5456
12	Leveling Foot, Deh	5457
13	Capacitor, 45MFD, 370VAC	5458
14	Capacitor, 6MFD, 250VAC	5582
15	RH Sensor, Deh	5460
16	Drain Tube + Fitting	5665
17	Compressor Overload Switch	5697
Not Shown		
	Condensate Pump with Tubing	4856

AprilairePartners.com
P.O. Box 1467
Madison, WI 53701-1467
800.334.6011 F: 608.257.4357
Printed in USA
©2017 **Aprilaire** – Division of Research Products Corporation
10012343 B2207621B 9.17

Aprilaire[®]