

# FOR SERVICE TECHNICIAN'S USE ONLY

Do not Discard

⚠ DANGER

Electrical Shock Hazard

Only authorized technicians should perform diagnostic voltage measurements.

After performing voltage measurements, disconnect power before servicing.

Failure to follow these instructions can result in death or electrical shock.

⚠ WARNING

Electrical Shock Hazard

Disconnect power before servicing.

Replace all parts and panels before operating.

Failure to do so can result in death or electrical shock.

Voltage Measurement Safety Information

When performing live voltage measurements, you must do the following:

- Verify the controls are in the off position so that the appliance does not start when energized.
- Allow enough space to perform the voltage measurements without obstructions.
- Keep other people a safe distance away from the appliance to prevent potential injury.
- Always use the proper testing equipment.
- After voltage measurements, always disconnect power before servicing.

## PRECAUTIONS TO BE OBSERVED BEFORE AND DURING SERVICING TO AVOID POSSIBLE EXPOSURE TO EXCESSIVE MICROWAVE ENERGY

<p><b>a.</b> Do not operate or allow the oven to be operated with the door open.</p> <p><b>b.</b> Make the following safety checks on all ovens to be serviced before activating the magnetron or other microwave source, and make repairs as necessary:</p> <ol style="list-style-type: none"> <li>1. Interlock Operation</li> <li>2. Proper Door Closing</li> <li>3. Seal and Sealing Surfaces (Arcing, Wear and Other Damage)</li> <li>4. Damage to or Loosening of Hinges and Latches</li> <li>5. Evidence of Dropping or Abuse</li> </ol> <p><b>c.</b> Before turning on microwave power for any service test or inspection within the microwave generating compartments, check the magnetron, wave guide or transmission line, and cavity for proper alignment, integrity and connections.</p>	<p><b>d.</b> Any defective or misadjusted components in the interlock, monitor, door seal, and microwave generation and transmission systems shall be repaired, replaced, or adjusted by procedures described in this manual before the oven is released to the owner.</p> <p><b>e.</b> A microwave leakage check to verify compliance with the Federal Performance Standard should be performed on each oven prior to release to the owner.</p> <p><b>f.</b> Do not attempt to operate the oven if the door glass is broken.</p>
--	---



W11415594B

FOR SERVICE TECHNICIAN'S USE ONLY

# FOR SERVICE TECHNICIAN'S USE ONLY

## FAILURE CODE INDICATIONS

**NOTE:** Many of the problems listed in the chart below may be solved by power cycling: Unplug microwave oven or disconnect power. After one minute, plug in microwave oven or reconnect power.

Display	Likely Failure Condition	Recommended Repair Procedure	
"Enter clock"	Power failure	After a power failure, "Enter clock" will be flashing. Press CANCEL to end this indication. The colon (:) will appear when in Standby mode.	
F2E1	Touch panel failure	<ol style="list-style-type: none"> <li>1. Unplug microwave oven or disconnect power.</li> <li>2. Replace touch panel.</li> <li>3. Replace all parts and panels before operating.</li> </ol>	<ol style="list-style-type: none"> <li>4. Plug in microwave oven or reconnect power.</li> <li>5. If problem persists, refer to "ACU Pin Voltage Matrix."</li> </ol>
F1E4	MW Relay	<ol style="list-style-type: none"> <li>1. Unplug microwave oven or disconnect power.</li> <li>2. Check wiring to Relay 4903</li> <li>3. Check to see if relay (4903 on ACU) contact has welded closed.</li> </ol>	<ol style="list-style-type: none"> <li>4. Replace all parts and panels before operating.</li> <li>5. Plug in microwave oven or reconnect power.</li> <li>6. If problem persists, refer to "ACU Pin Voltage Matrix" to check P2-2 (Door), P1-3 (N), and P1-1(L).</li> </ol>
F4E4	Humidity sensor error	<ol style="list-style-type: none"> <li>1. Enter the Diagnostics mode (press CANCEL - CANCEL - START), and then press COOK to display the humidity sensor reading. If display does not show The value between "2000 and 9000" continue to Step 2.</li> <li>2. Unplug microwave oven or disconnect power.</li> <li>3. Connect a new humidity sensor ACU to cable.</li> <li>4. Replace all parts and panels before operating.</li> <li>5. Plug in microwave oven or reconnect power.</li> </ol>	<ol style="list-style-type: none"> <li>6. Enter the Diagnostics mode (press CANCEL - CANCEL - START), then press COOK to see if failure code reappears.</li> <li>7. If the F4E4 failure code reappears, unplug microwave oven or disconnect power.</li> <li>8. Replace ACU.</li> <li>9. Replace all parts and panels before operating.</li> <li>10. Plug in microwave oven or reconnect power.</li> </ol>

## PRIMARY, SECONDARY, MONITOR, AND DOOR INTERLOCK SWITCH CHECKOUT PROCEDURES

**IMPORTANT:** Before checking the interlock switches, unplug microwave oven or disconnect power. Be sure to disconnect all of the wires at the switch being tested before making any continuity readings.

**NOTE:** The Secondary Interlock Switch, Monitor Interlock Switch, Primary Interlock Switch, and Door Interlock Switch are mounted in the door lock switch cradle. All the interlock switches can be identified by the wire colors that are connected to the terminals of the switches. See the chart below for wire color designation.

Switch	Check By	Door Open	Door Closed
Primary Interlock	<ol style="list-style-type: none"> <li>1. Unplug microwave oven or disconnect power.</li> <li>2. Disconnect the wires at the Primary Interlock Switch.</li> <li>3. Check from the common terminal (black/black wires) to the normally open terminal (black/white wires).</li> <li>4. Reconnect wires to switch.</li> </ol>	-	+
Monitor Interlock	<ol style="list-style-type: none"> <li>1. Unplug microwave oven or disconnect power.</li> <li>2. Disconnect the wires at the Monitor Interlock Switch.</li> <li>3. Check from the common terminal (white wire) to the normally closed terminal (blue/blue wires).</li> <li>4. Reconnect wires to switch.</li> </ol>	+	-
Secondary Interlock	<ol style="list-style-type: none"> <li>1. Unplug microwave oven or disconnect power.</li> <li>2. Disconnect the wires at the Secondary Interlock Switch.</li> <li>3. Check from the common terminal (white/white wires) to the normally open terminal (blue/black wires).</li> <li>4. Reconnect wires to switch.</li> </ol>	-	+
Door Interlock	<ol style="list-style-type: none"> <li>1. Unplug microwave oven or disconnect power.</li> <li>2. Disconnect the wires at the Door Interlock Switch.</li> <li>3. Check from the common terminal (blue wire) to the normally closed terminal (orange wire).</li> <li>4. Reconnect wires to switch.</li> </ol>	+	-

(+) Continuity (-) No Continuity

**NOTES:**

- These diagrams are not intended to show a complete circuit; they represent the position of switches during "DOOR OPEN" or "DOOR CLOSED" (continuity checks only).
- Interlock and monitor switches cannot be adjusted and all these switches should be replaced if any one of them is found to be defective. After replacing interlock/monitor switches, reconnect wires to switch and check for continuity. Safety interlocks and monitor switches will actuate within 2 mm.

# FOR SERVICE TECHNICIAN'S USE ONLY

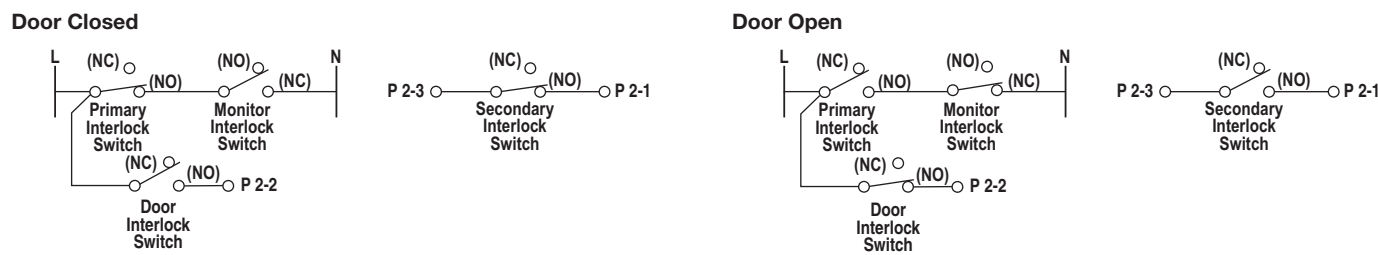

## NOT HEATING TROUBLESHOOTING INSTRUCTION

**IMPORTANT:** High-voltage is present at the magnetron and high-voltage capacitor terminals. Avoid direct contact when power is connected to these components to avoid serious injury or possible death. Always be sure that the high-voltage capacitor is discharged before accessing any of these components.

For a no-heat condition, refer to the following step-by-step instructions:

1. Unplug microwave oven or disconnect power.
2. Discharge the high-voltage capacitor.
3. Disconnect the high-voltage transformer primary windings.
4. Attach the voltmeter leads to the high-voltage transformer primary input wires.
5. Plug in microwave oven or reconnect power.
6. Close door and program the microwave oven to operate for 30 seconds.
7. Press START.
8. Check the input voltage at the high-voltage transformer primary input wires. If the voltage is not close to the rating voltage 120 ± 15 VAC, unplug microwave oven or disconnect power. Check the circuitry as follows:

- Measure resistance of the fuse, micro-switches, and thermostats. Replace any failed components. (Refer to the wiring diagram.)
- Check for loose terminals. (Refer to the wiring diagram.) Check all of the terminals on the main route from the power supply to the high-voltage transformer.

## ACU PIN VOLTAGE MATRIX

Check for proper voltage by completing the following steps:

1. Unplug microwave oven or disconnect power.
2. Connect voltage measurement equipment to the terminals listed below. (P1-3 and P2-3 are neutral.)
3. Plug in microwave oven or reconnect power, and confirm voltage reading.
4. Unplug microwave oven or disconnect power.

**NOTE:** For 50 V and over, the tolerance is ± 15 V. For 0 V, the tolerance is ± 3 V.

# FOR SERVICE TECHNICIAN'S USE ONLY

**Abbreviations**

N - Neutral CL - Cavity Light L - Line Voltage TT - Turntable Motor NFS - Neutral for Switch

**NOTE:** When checking voltage readings on ACU, connect the Negative test lead of voltmeter to connector P1-3. Use the positive test lead to probe connectors designated below.

Pin Name	Wire Color	MW Oven Plugged In—Sitting Idle—ACV Readings		MW Oven Running— ACV Readings
		Power On, Door Closed	Power On, Door Open	Microwave Oven Start
P1-1 (L)	BLACK	120	120	120
P1-3 (N)	BLUE	0	0	0
P2-1 (NFS)	BLUE AND GREEN	0	0	0
P2-2 (Door)	ORANGE	0	120	38
P2-3 (N)	WHITE AND BLACK	0	120	0
P4-1 (CL/CF)	BLACK	0	120	120
P4-2 (TTM)	RED	0	0	120
P4-4 (ODM)	BLACK	0	0	0

## CONNECTORS ON PCBA

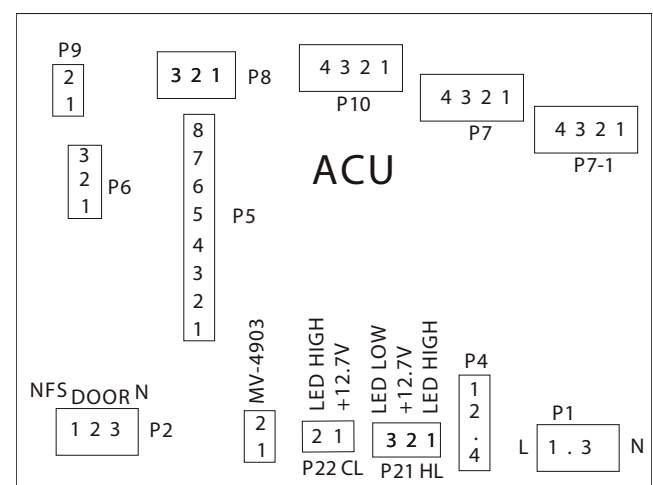

**NOTE:** There is a empty terminal on P1 and P4 connector.

## TOUCH PANEL

### Touch Panel and ACU Test

The microwave hood combination is provided with a self-diagnostic routine that can be accessed through the touch keypad.

**To initiate this routine:**

1. Plug in microwave oven or reconnect power. In idle mode, close the door, turn off hood light and hood fan.
2. Open and close door, then press CANCEL - CANCEL - START within 3 seconds.
3. Open door. The model number will be displayed.
4. Close door. All display segments will be lit.
5. Press indicated keypad for correct display readout and beep.

All LED/LCD segments will be lit to indicate the Test mode has been entered.

**NOTE:** If the Cancel button is pressed during this diagnostic routine, you will exit the Test mode.

## FOR SERVICE TECHNICIAN'S USE ONLY

### Key Tables for Test Mode

Key Name	The Upper Row Display	Function	Buzzer
Option/Clock	key CLK	-	1 beep
Start	ACU xx.xx.xx	ACU SW version check	1 beep
Start	UI:xx.xx.xx	UI SW version check	1 beep
Start	Touch:xx	Touch SW version check	1 beep
Start	GEE:xx.xx.xx	GEE SW version check	1 beep
Timer Set.Off	key 05	-	1 beep
Turntable On/Off	key 09	-	1 beep
Cook	value between 2000 and 9000	Humidity sensor check	1 beep
Power	-	-	1 beep
Reheat	key 24	-	1 beep
Defrost	key 29	-	1 beep
Popcorn	key 25	-	1 beep
Soften/Melt	key 31	-	1 beep
0	key 10	-	1 beep

Key Name	The Upper Row Display	Function	Buzzer
1	CL	Cavity lamp turn on	1 beep
2	11		1 beep
3	Key 03		1 beep
4	Key 04		1 beep
5	LCD is low brightness	Standby power check	1 beep
6	Key 06		1 beep
7	Key 07		1 beep
8	Key 08		1 beep
9	Key 09		1 beep
Cancel	: or xx:xx	Exit test mode to idle mode	1 beep

### PARTS LAYOUT (NOT TO SCALE)

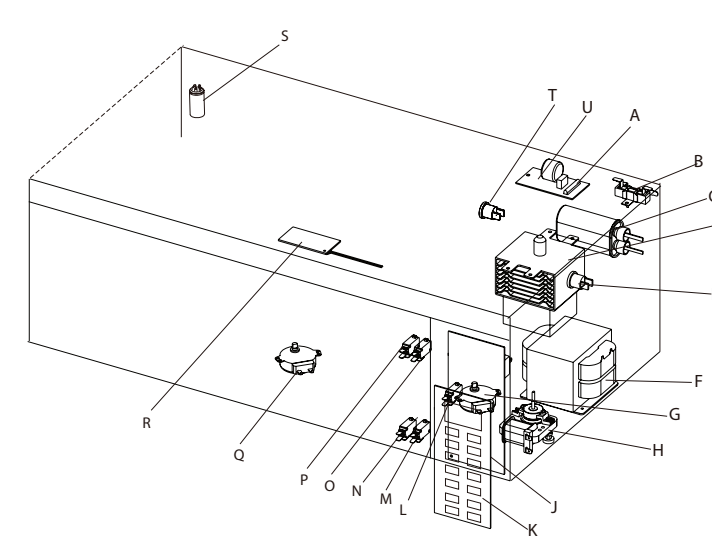

- A. Main fuse 20 A
- B. Cement resistor
- C. H.V. capacitor
- D. Magnetron
- E. Magnetron Thermostat - opens at 293°F (145°C), closes at 221°F (105°C)
- F. HV transformer
- G. Open door motor
- H. Cooling fan motor
- J. ACU
- K. Touch panel
- L. Door open switch
- M. Secondary Interlock Switch
- N. Door Interlock Switch
- O. Monitor Interlock Switch
- P. Primary Interlock Switch
- Q. Turntable motor
- R. Cavity light
- S. AC filter
- T. Cavity thermostat-opens at 221°F (105°C), non-resettable
- U. Filter board

### POWER OUTPUT MEASUREMENT

The power output of the magnetron can be measured using the following "Voltage Measurement at Power Source" and "Output Test" sections. Before you perform the test:

- Make sure that the oven cavity is cool and clean.
- Check the line voltage at the wall outlet while microwave oven is operating. See the "Voltage Measurement at Power Source" section.

## FOR SERVICE TECHNICIAN'S USE ONLY

### Tools Needed

- 2-cup measuring cup
- Thermometer
- Voltmeter/ohmmeter

### Voltage Measurement at Power Source

- Fill the measuring cup with 2 cups (500 mL) of tap water.
- Place in the center of the microwave oven cavity.
- Operate the microwave oven on high power for 1 minute.
- While the microwave oven is operating, measure the line voltage at the power source. See "Measure Voltage" illustration.
- Verify the voltage is constant during microwave oven operation. If voltage drops below 108 V, contact a qualified electrician to check your electrical supply.
- Make note of the voltage while the microwave oven is running and proceed to the output test.

### Measure Voltage

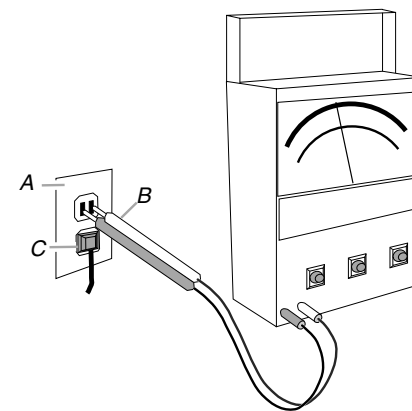

- A. House power supply wall outlet
- B. Voltmeter/ohmmeter test leads
- C. Microwave oven plug

### Output Test

- Fill the measuring cup with 2 cups (500 mL) of 70°F (21°C) tap water.
- Stir the water with the thermometer to ensure uniform temperature. Add warm or cool water to bring the water to the correct temperature.
- Place the measuring cup in the center of the microwave oven cavity.
- Operate the microwave oven on high power for 1 minute.
- Remove the measuring cup and stir the water with the thermometer for about 20 seconds.
- Record the temperature of the water.
- Refer to the model serial tag on the microwave oven to acquire wattage output rating of the microwave oven.

- Using the following chart, determine if the output of the microwave oven is within the range listed based on the line voltage and wattage rating of the microwave oven.

Voltage	Water Temperature for Line Voltage and Wattage Rating		
	700 W	1000 W	1200 W
120 V	96°F to 102°F (36°C to 39°C)	110°F to 116°F (43°C to 47°C)	124°F to 130°F (51°C to 54°C)
108 V	91°F to 97°F (33°C to 36°C)	101°F to 107°F (38°C to 42°C)	111°F to 117°F (44°C to 47°C)

## COMPONENT TESTS

### IMPORTANT:

- Unplug microwave oven or disconnect power.
- Discharge the high-voltage capacitor and remove the lead wires from the primary winding of the high-voltage transformer before conducting any of the following tests.
- Remove the lead wires from the related component before conducting any of the following tests.
- All operational checks using microwave energy must be done with the microwave oven loaded with a minimum of 8 oz (250 mL) of water in a microwave-safe container.
- Conduct a microwave energy test after performing any tests or repairs to the microwave oven.
- Check that all wire leads are in the correct positions before operating the microwave oven.
- Grasp wire connectors when removing the wire leads from microwave oven parts.
- All testing must be done with an ohmmeter having a sensitivity of 20,000 ohms per volt DC or greater and powered by at least a 9 V battery.

### Components

#### H.V. Transformer

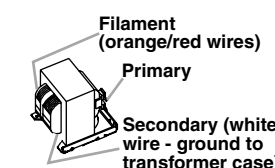

- Unplug microwave oven or disconnect power.
- Remove wire leads.
- Measure resistance:
  - Primary winding: Less than 0.5 ohm (approximate)
  - Secondary winding: 120 ohms (approximate)
  - Filament winding: 0 ohms
  - Primary winding to grounding: Normal: Infinite
  - Filament winding to grounding: Normal: Infinite

#### Magnetron

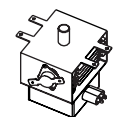

- Unplug microwave oven or disconnect power.
- Remove wire leads.
- Measure resistance:
  - Filament terminal: Normal: Less than 1 ohm
  - Filament to chassis: Normal: Infinite

## FOR SERVICE TECHNICIAN'S USE ONLY

### Components

#### H.V. Capacitor

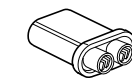

- Unplug microwave oven or disconnect power.
- Remove wire leads.
- Measure resistance:
  - Terminal to terminal: Normal: Momentarily indicates several ohms, gradually returns to Infinite
  - Terminal to case: Normal: Infinite

#### H.V. Diode

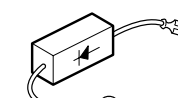

- NOTE:** Some inexpensive meters may indicate infinite resistance in both directions.
- Unplug microwave oven or disconnect power.
  - Measure resistance:
    - Forward: Normal: Continuity
    - Reverse: Normal: Infinite

#### Turntable Motor/Open Door Motor

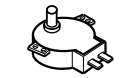

- Unplug microwave oven or disconnect power.
- Remove wire leads.
- Measure resistance:
  - Normal: 2.4k to 3.2k ohms (approximate)

#### Humidity Sensor PCBA

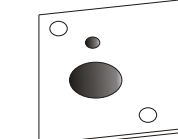

- Unplug microwave oven or disconnect power.
- Remove the 4-pin connector from the cable.
- Measure resistance across pins 1 and 2.
  - Normal: 10K ohms +/-5% at 77°F (25°C)
- Measure capacity value across pins 3 and 4.
  - Normal: 180pF +/-5% at 55%RH

#### HF NTC Thermistor

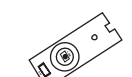

- If "NTC SHORT, CALL FOR SERVICE" or "NTC OPEN, CALL FOR SERVICE" scrolls on display, unplug microwave oven or disconnect power.
- Measure hood thermistor:
  - Normal: 10k ohms +/-5% at 77°F (25°C)

#### AC Line Filter Board

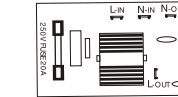

- Unplug microwave oven or disconnect power.
- Remove wire leads.
- Measure resistance:
  - Normal: L-IN to L-OUT (coil): Less than 1 ohm; N-IN to N-OUT (coil): Less than 1 ohm

#### Thermostats



- NOTE:** Refer to "Parts Layout" for opening and closing temperatures.
- Unplug microwave oven or disconnect power.
  - Remove wire leads.
  - Measure continuity:
    - Normal: Continuity

#### Open Door Switch

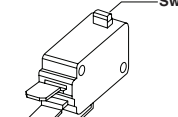

- Unplug microwave oven or disconnect power.
- Remove wire leads.
- Make sure the switch is pressed
- Measure resistance:
  - Normal: >1M ohm
  - Abnormal: <5 ohm

## FOR SERVICE TECHNICIAN'S USE ONLY

### SCHEMATIC DIAGRAM

