

## 0034e™ ECM High-Efficiency Circulator

The 0034e™ is a high-performance, variable speed, wet-rotor circulator with high-efficiency ECM permanent magnet technology. With 5 easy settings, its variable speed performance curves are equivalent to the Taco 009, 0010, 0011, 0012, 0012 3-Speed, 0013, 0013 3-Speed & 0014. Ideal for large residential and light commercial hydronic heating, chilled water cooling and domestic hot water systems. The 0034e reduces power consumption by up to 85% compared to equivalent AC permanent split capacitor circulators. With a maximum of 34 feet of head and 50 gpm, it is available in either Cast Iron or NSF certified Stainless Steel.



## Applications



### APPLICATION:

- Maximum operating pressure: 150 psi (10.3 bar)
- Minimum NPSHR: 18 psi at 203°F (95°C)
- Maximum fluid temperature: 230°F (110°C)
- Minimum fluid temperature: 14°F (-10°C)
- Electrical specifications:
  - Voltage: 115/208/230V, 50/60 Hz, single phase
  - Maximum operating power: 170W
  - Maximum amp rating: 1.48 (115V) / .70 (230V)
- Equipped with a cast iron or stainless steel casing
- Stainless Steel model suitable for open loop potable water systems
- Taco circulators are for indoor use only
- Acceptable for use with water or maximum of 50% water/glycol solution

## Easy-to-use dial

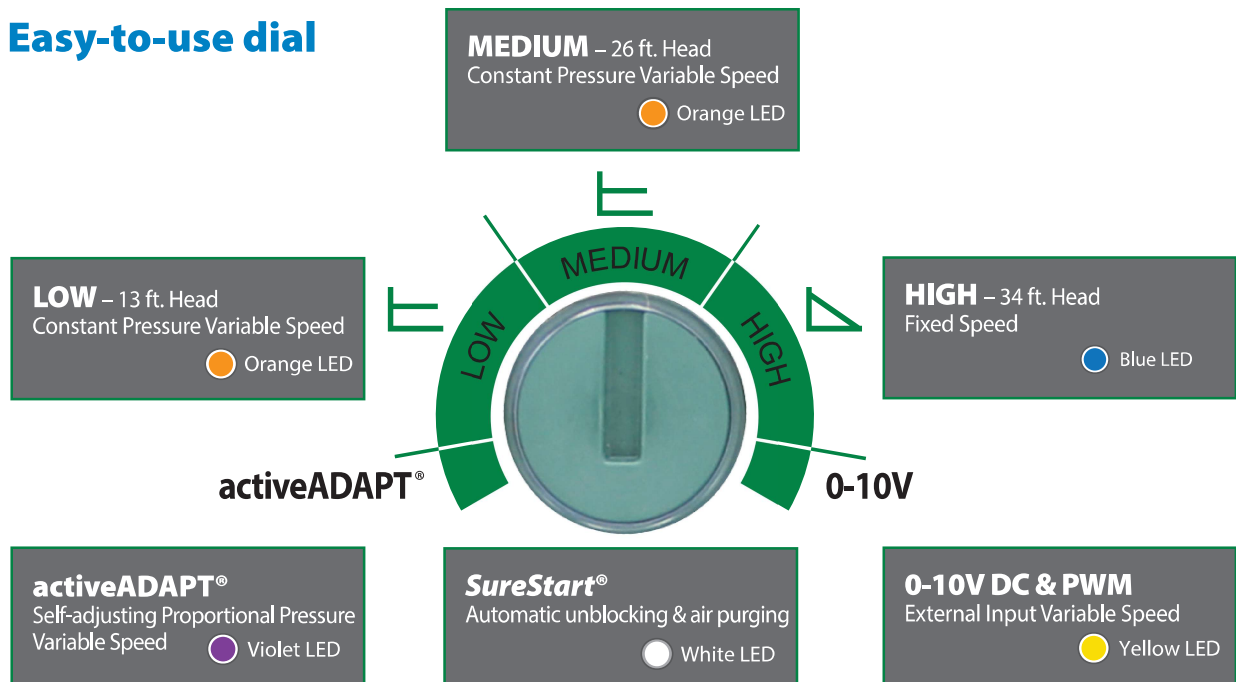

## Features



### FEATURES:

- 5 easy dial settings to match system requirements
  - activeADAPT®, LOW, MEDIUM, HIGH or 0-10V DC analog or PWM digital signal external input
- **BIO Barrier®** protects the pump from system contaminants
- **SureStart®** automatic unblocking and air purging mode
- Replaces all single speed and 3-speed circulators in its class
- Multi-color LED: power on, mode setting and error code diagnostics
- Use with a Taco ZVC Zone Valve Control or SR Switching Relay for ON/OFF operation
- Nut-grabber feature on flanges for easier fit up
- Dual electrical knockouts and removable quick-connect terminal strip for easy wiring
- Whisper quiet operation
- Rotatable control cover to simplify installation

### Pump Replacement Chart (6-1/2" Flange-to-Flange Dimension)

Taco	Bell & Gossett	Armstrong	Grundfos	Wilo
2400-10	PL 50	E 11	TP(E) 32-40	Stratos:
2400-20	PL 45	E 10	UP 50-75	1.25 x 3 – 35
2400-30	PL 36	E 8	UPS 43-100	1.25 x 3 – 30
2400-40	PL 30	E 7	UPS 50-44	1.25 x 3 – 25
110	E90 1AAB	S 25	UP 43-75	1.25 x 3 – 20
111	Series 60 (601)	H 63	UP(S) 43-44	
112	Series HV	H 52	UP 26-116	Top S:
113	Series PR	H 51	UP(S) 26-99	1.25 x 15
009	Series HV	Astro 290	UP 26-96	1.25 x 25
0010	Series 100	Astro 280	UP 26-64	1.25 x 35
0011	NRF 45	Astro 210	UPS 32-40	1.50 x 20
0012	NRF 36	1050 1B	UPS 32-80	
0013	ECOCirc XL 36-45	1050 1 1/4B	Magna 32-100	Top Z:
0014		Compass ECM	Magna 32-60	1.5 x 15
VR3452			Alpha2 26-99	1.5 x 20

NOTE: Flange size and flange-to-flange dimensions will vary by competitive model and may require some piping changes.



Certified to  
NSF/ANSI 61 & 372

Stainless Steel  
Model Only

# Performance Curves

## activeADAPT® Mode:

activeADAPT is an operating mode designed for constant circulation systems. On this setting, the circulator will sense changes in system flow and head conditions and adjust the operating curve automatically.

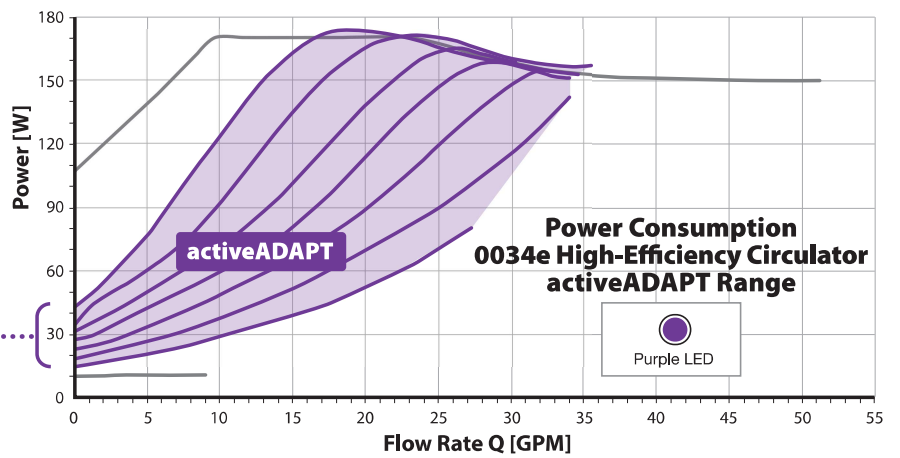
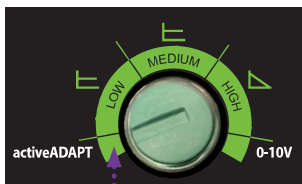
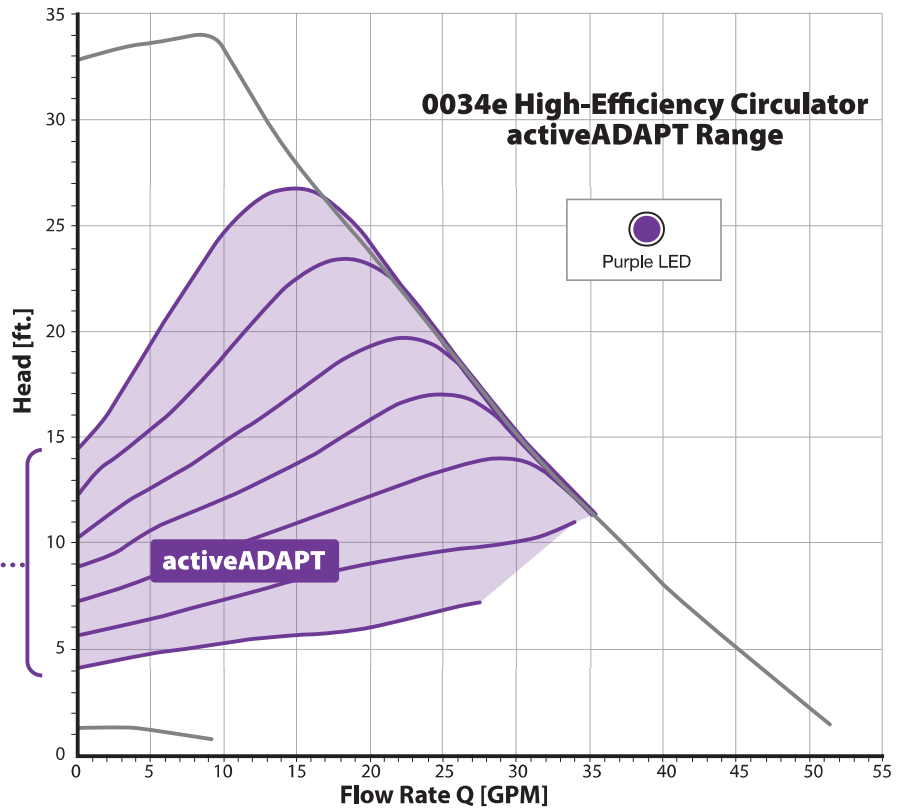
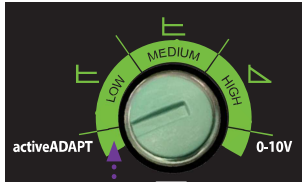

## Constant Pressure Mode:

At Low setting the circulator will vary speed to maintain 13 feet of head constant pressure. At Medium setting the circulator will vary speed to maintain 26 feet of head constant pressure.

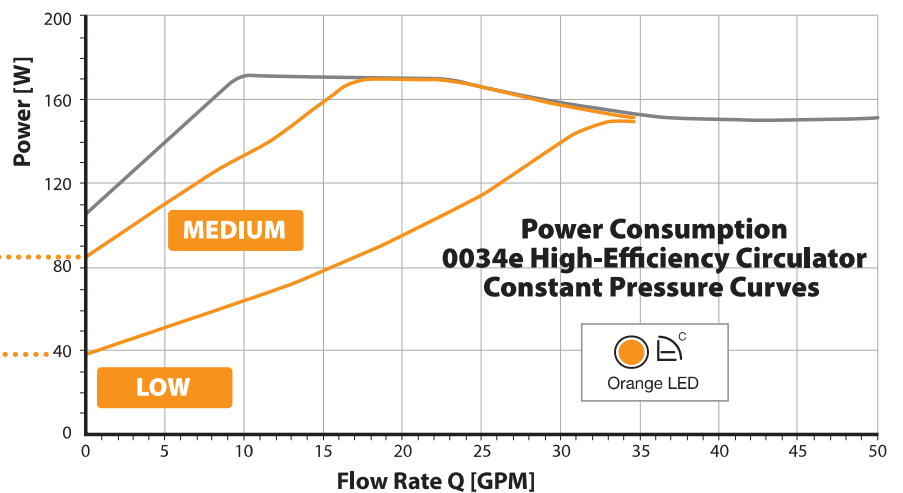
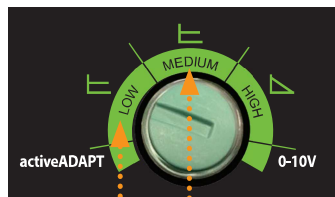
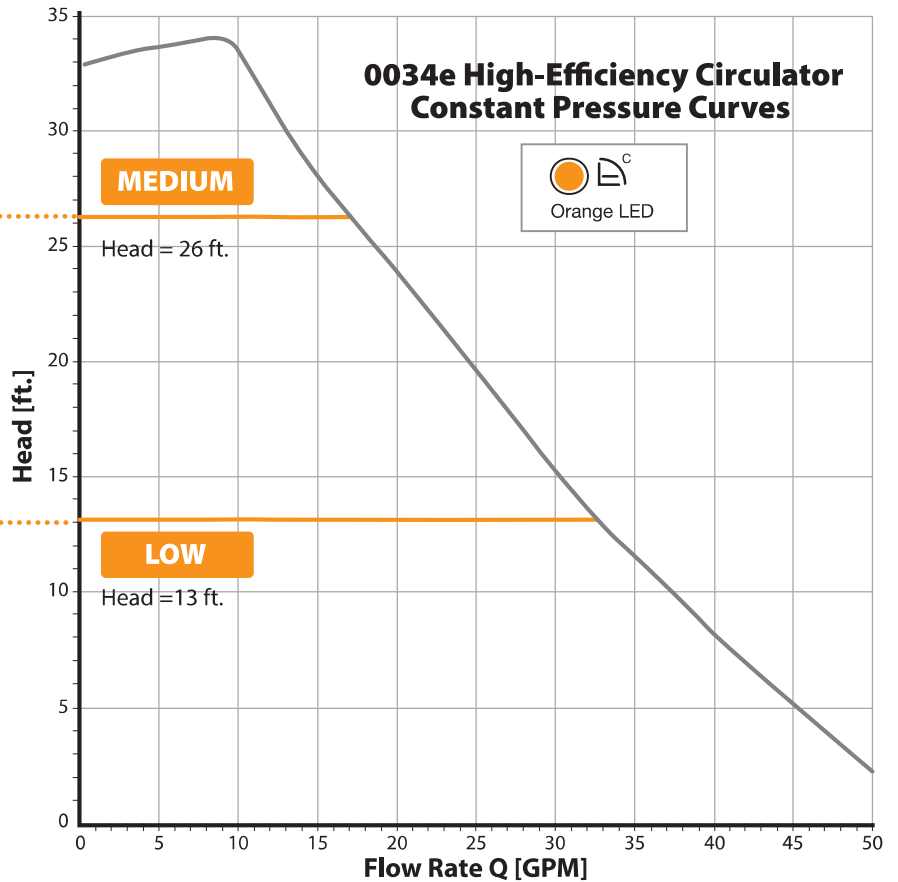
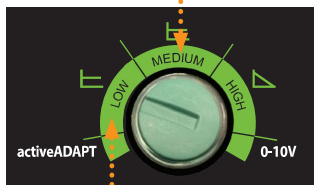

# Performance Curves

## Fixed Speed Mode:

At High setting the circulator always operates at full speed.

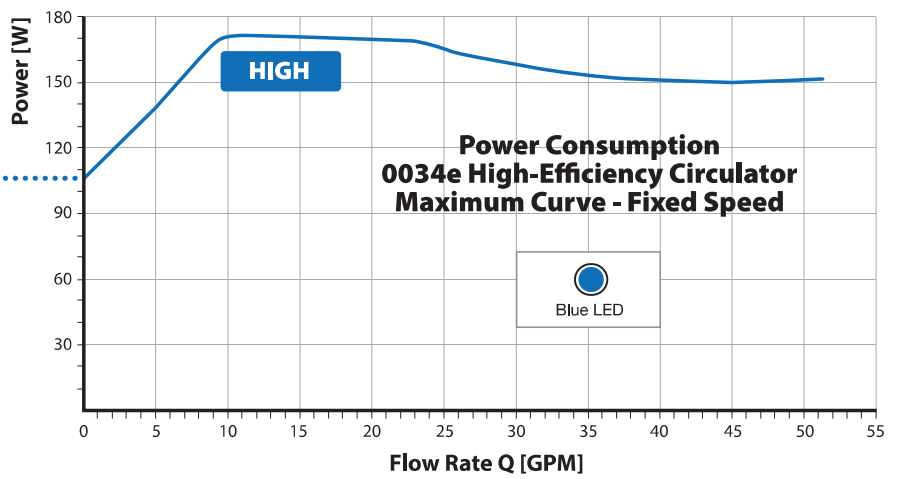
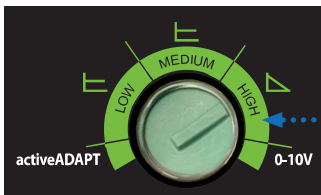
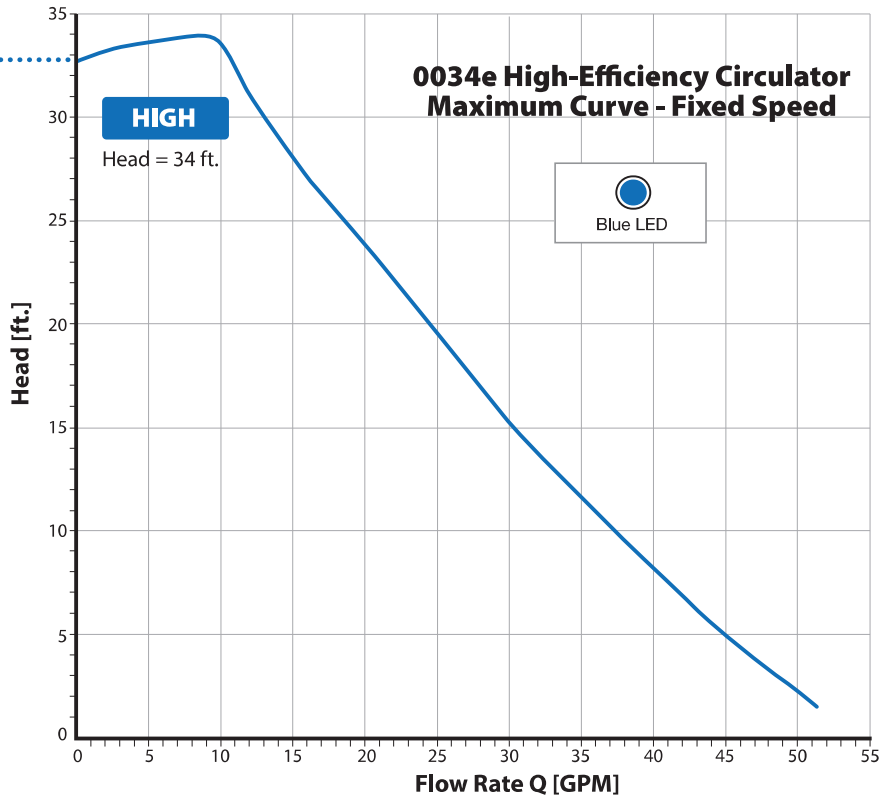
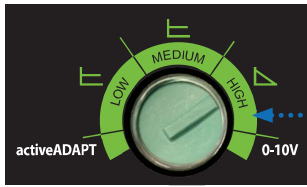

# Performance Curves

## 0-10V DC or PWM External Input:

The circulator will vary its speed and performance based on a 0-10V DC analog or PWM digital signal external input.

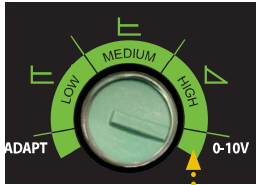

0-10V

### PWM (Pulse Width Modulation)

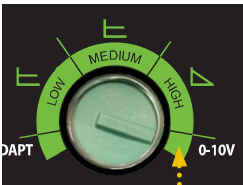
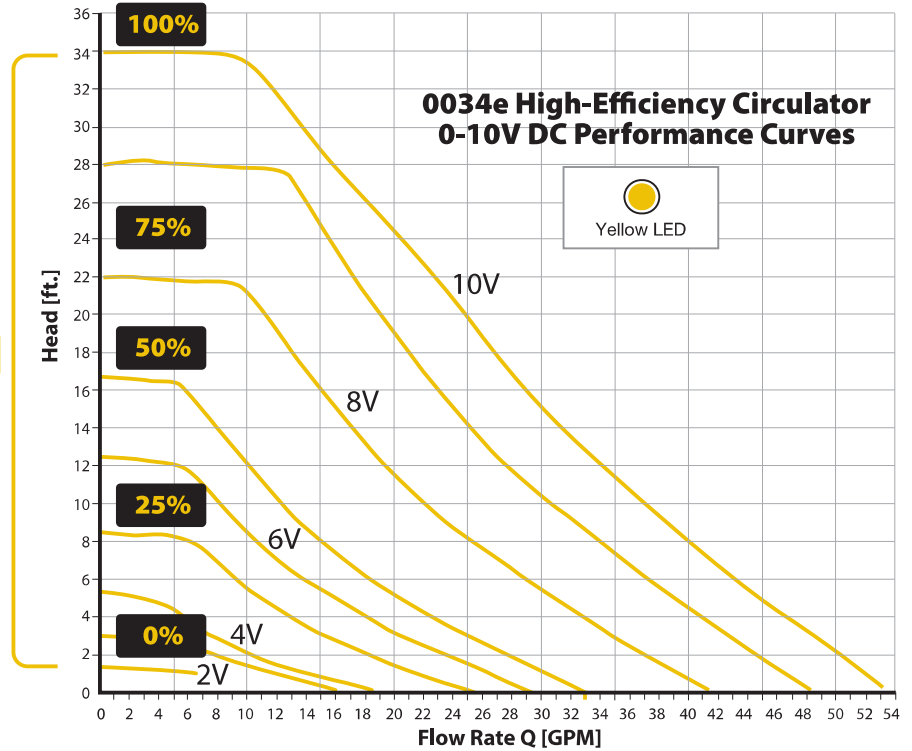

0-10V

### Power Consumption 0034e High-Efficiency Circulator 0-10V DC Curves

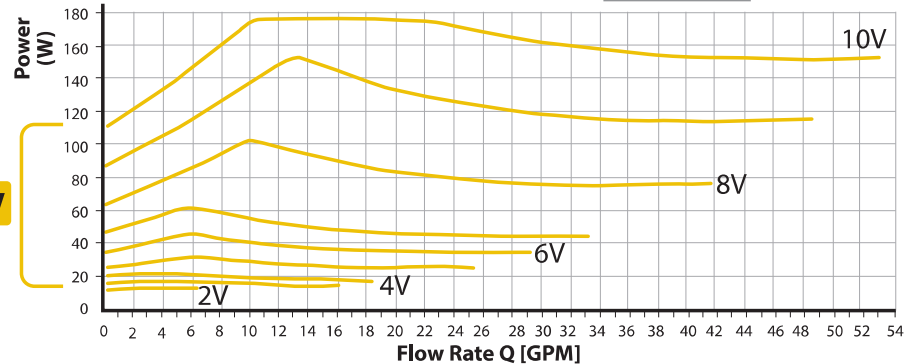

# Submittal Data Information 0034e™ ECM Circulator

Submittal Data # 101-192

Effective: 12/17/21

Supersedes: 08/16/21

## Specifications

- Maximum Shut-off Head: 34 feet
- Maximum Flow: 50 gpm
- Maximum Operating Pressure: 150 psi (10.3 bar)
- Maximum Water Temp: 230°F (110°C)
- Minimum Water Temp: 14°F (-10°C)
- Electrical specifications:
  - Voltage: 115V/208/230, 50/60 Hz Single phase
  - Operating Power Range: 10 - 170W
  - Max. AMP Rating: 1.48 (115V) - 0.70 (230V)
- Equipped with a Cast Iron or Stainless Steel casing
- Suitable for chilled water systems
- Stainless Steel model suitable for open loop potable water systems
- Taco circulators are for indoor use only
- Acceptable for use with water or maximum of 50% water/glycol solution
- 6.5" Flange to Flange dimension retrofits most circulators in its class

## Materials of Construction:

Casing: ..... Cast Iron or Stainless Steel  
 Stator Housing: ..... Composite  
 Control Base: ..... Composite  
 Control Cover: ..... Composite  
 Cartridge: ..... Composite  
 Impeller: ..... Composite  
 Shaft: ..... Ceramic  
 Rotor: ..... Neodymium  
 Bearings: ..... Ceramic  
 Thrust Bearing: ..... Carbon  
 O-Ring & Gaskets: ..... EPDM

## Applications

**Cast Iron Model:** Closed loop, pressurized heating and chilled water HVAC systems  
**Stainless Steel Model:** Open loop, potable water systems

The 0034e is a high-performance, variable speed, wet-rotor circulator with high-efficiency ECM permanent magnet technology. With 5 easy settings, its variable speed performance curves are equivalent to the Taco 009, 0010, 0011, 0012, 0012 3-Speed, 0013, 0013 3-Speed & 0014. Ideal for large residential and light commercial hydronic heating, chilled water cooling and domestic hot water systems. The 0034e reduces power consumption by up to 85% compared to equivalent AC permanent split capacitor circulators.

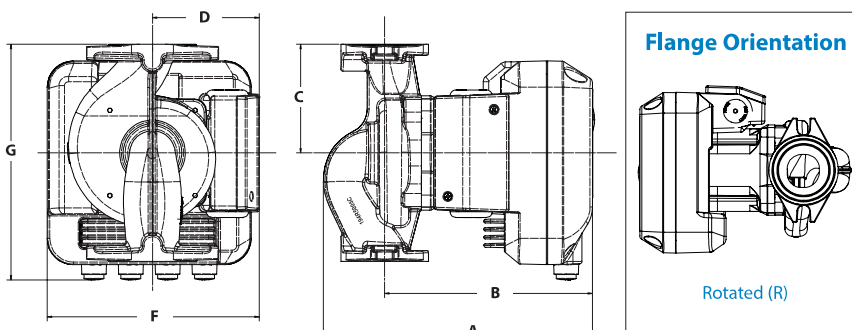

## Pump Dimensions & Weights

Model Number	Casing	Flange Type	A	B	C	D	F	G	Wt.lbs. [kg]
			Inches [mm]						
0034e-F2	Cast Iron	R	8.05" [205]	6.22" [158]	3.25" [83]	3.20" [81]	6.22" [158]	7.05" [179]	10.5 [4.8]
0034e-SF2	Stainless Steel								

## Electrical Data

Model	Volts	Hz	Ph	Max Amps	Watts	RPM
All Models	115/208/230	50/60	1	1.48	10 - 170	830 - 4300
Motor Type	ECM, Permanent Magnet, Electronically Protected					

## Rotatable Control Cover to allow mounting in any orientation

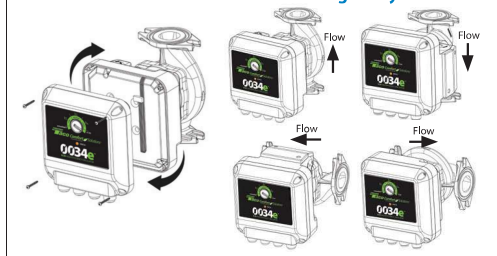

**HYDRAULIC ENERGY INSTITUTE RATING**

Model #: 0034e WAIP: 0.250

**CIRCULATOR PUMP CEI: 0.50 (ER 145)**

**ENERGY RATING**

107 145

Most Consumptive RANGE Least Consumptive

Note: The ER value is dependent on the selected control. Multiple options may be available on this pump, as follows:

- Full Speed
- Pressure (Rated)
- External Input Signal and Other Controls

Power savings (watts) over a baseline case can be estimated by multiplying the ER by WAP and multiplying by 7.45. Multiplying power savings by operating hours and cost of energy will yield estimated cost savings.

4PN6JP er.pumps.org Apr 2021



Taco Inc., 1160 Cranston Street, Cranston, RI 02920 / (401) 942-8000 / Fax (401) 942-2360  
 Taco (Canada) Ltd., 8450 Lawson Road, Unit #3, Milton, Ontario L9T 0J8 / (905) 564-9422 / Fax (905) 564-9436