

BRIZO®

INTEGRATED SHOWER DIVERTER TRIM

- Litze® Bath Collection
- MultiChoice® Valve Trim with Three Function Diverter (T75535-LHP)
- MultiChoice® Valve Trim with Six Function Diverter (T75635-LHP)

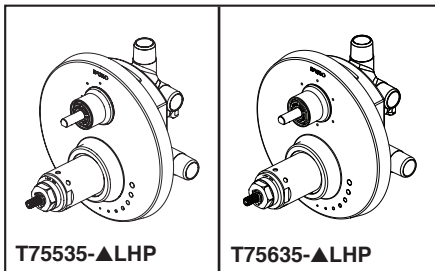

Submitted Model No.: _____

Specific Features: _____

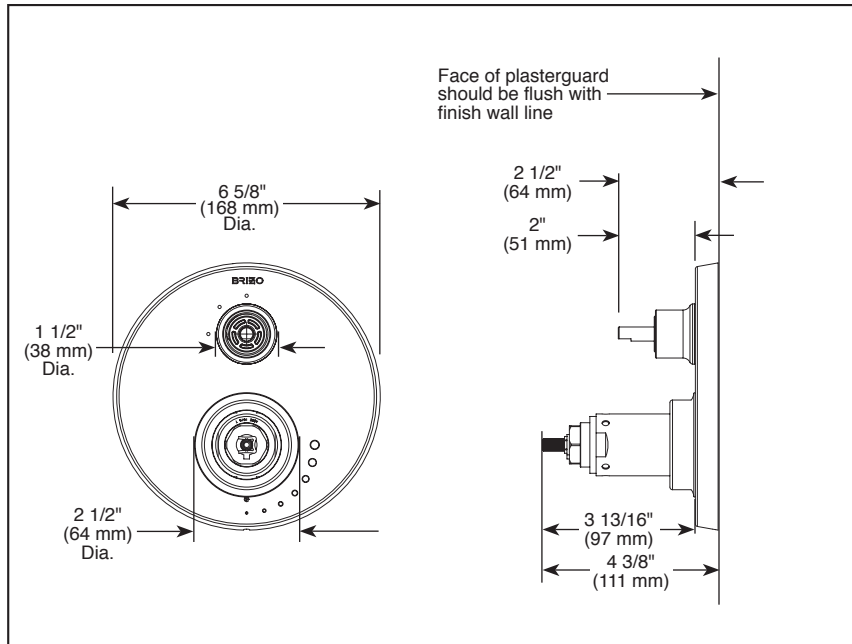

FEATURES:

- TempAssure® thermostatic valve cartridge
- Three or six function diverter

STANDARD SPECIFICATIONS:

- Main control utilizes thermostatic valve cartridge.
- Thermostatic wax element maintains the outlet temperature to $\pm 3.6^\circ\text{F}$.
- Back-to-back installation capability
- For use with MultiChoice® Universal Integrated Shower Diverter Rough (R75000 Series)
- Max. system flow rate 7.2 gpm @ 60 psi with R75000.
- Top handle controls diverter functions.
- Bottom (2) handles control on/off and temperature.
- Field adjustable to limit handle rotation into hot water zone.
- Bottom handle 90° Maximum rotation.
- Hot/cold indicator markings.
- Three function diverter (T75535-▲LHP) has 2 individual positions and 1 shared position.
- For two individual functions, no shared functions, order additional RP72123.
- Six function diverter (T75635-▲LHP) has 3 individual positions and 3 shared positions.
- For three individual functions, no shared functions, order additional RP72124.
- 1/2" rough-in.
- Cartridges included.
- Standard installation allows up to 1 1/8" finished wall thickness.
- Thick wall installation kit RP90545▲ can be ordered to allow for up to 2 1/8" finished wall thickness.
- Handles sold separately. T-Lever handles have textural knurling detail. Industrial Lever handles are debossed with TEMP and VOL letters.

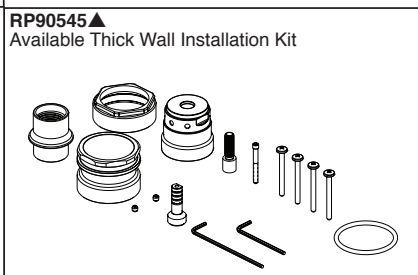
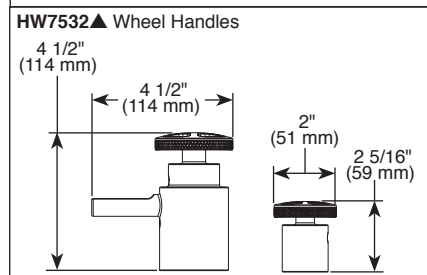
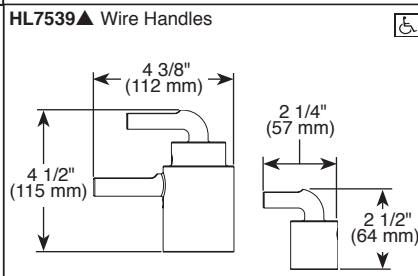
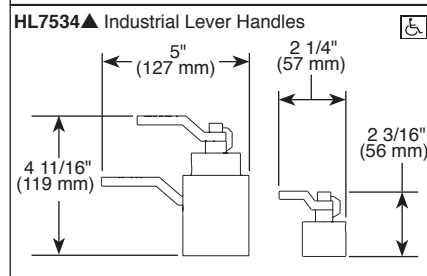
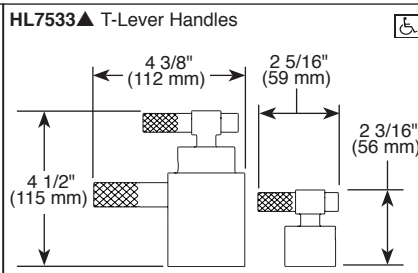
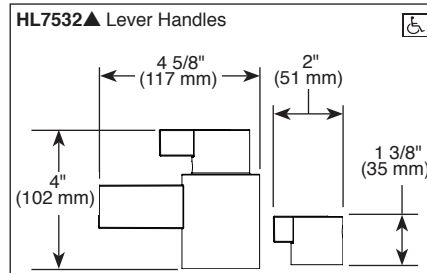

WARRANTY

- Parts and Finish - Lifetime limited warranty; or for commercial purchasers, 10 years for multi-family residential (apartments and condominiums) and 5 years for all other commercial uses, in each case from the date of purchase.
- Electronic Parts and Batteries (if applicable) - 5 years from the date of purchase; or for commercial purchasers, 1 year from the date of purchase. No warranty is provided on batteries.

COMPLIES WITH:

- ASME A112.18.1 / CSA B125.1
- Indicates compliance to ICC/ANSI A117.1 - Valve control only

▲ Designate Proper Finish Suffix

Brizo Kitchen & Bath Company reserves the right (1) to make changes in specifications and materials, and (2) to change or discontinue models, both without notice or obligation. Dimensions are for reference only. See current full-line price book or www.brizo.com for finish options and product availability.