

OMNI+ Compound (C²) Water Meter

1-1/2", 2", 3", 4", 6", 8" and 10"

The OMNI™+ Compound (C²) Water Meter operation is based on advanced Floating Ball Technology (FBT).

Performance

The patented measurement principles of the OMNI+ C² meter ensure greater accuracy, expanded accuracy range and longer service life than any other comparable class meter. The OMNI+ C² meter has no restrictions on sustained flow rates within its continuous range. The floating ball measurement technology allows installation in any orientation and flows up to maximum rated capacity without undue wear or accuracy degradation.

Construction

The OMNI+ C² meter consists of two basic assemblies; the maincase and the measuring chamber. The measuring chamber assembly includes the "floating ball" impeller with a coated titanium shaft, hybrid axial bearings, integral flow straightener and an all electronic programmable register with protective bonnet. The maincase is made from industry proven Ductile Iron with an approved NSF epoxy coating. Maincase features are; easily removable measuring chamber, unique chamber seal to the maincase using a high pressure o-ring, testing port and an AWWA compliant strainer.

OMNI™+ REGISTER DISPLAY



Segment Test View

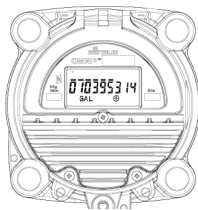

Totalizer View

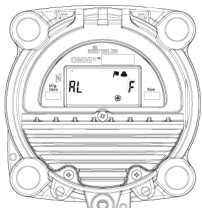

Notification View

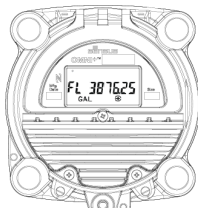

Flow Rate View

Conformance to Standards

The OMNI+ C² meter meets and far exceeds the most recent revision of AWWA Standard C701 class II and meets the AWWA Standard C702 class II accuracy standards. Each meter is performance tested to ensure compliance. All OMNI meters are NSF/ANSI Standard 61, Annex F and G approved latest standards.

OMNI+ Electronic Register

The OMNI+ electronic register is hermetically sealed with an electronic pickup containing no mechanical gearing. The OMNI+ register features a programmable totalizer registration, an optional digital pulse signal, AMI/ AMR reading digits, and a resettable test totalizer. The large, easy-to-read LCD also displays both forward and reverse flow directions. The OMNI+ tamper-proof security cover can be positioned in any of 270 degrees of rotation, with indexing points at each of the 90-degree customary register viewing positions.

Magnetic Drive

Meter registration is achieved by utilizing a fully magnetic pickup system. This is accomplished by the magnetic actions of the embedded rotor magnets and the ultra sensitive register pickup probe. The only moving component in water is the "floating ball" impeller.

Measuring Element

The hydro-dynamically balanced impeller floats between the bearings. The Floating Ball Technology (FBT) allows the measuring element to operate virtually without friction or wear, thus creating the extended upper and lower flow ranges capable on only the OMNI+ C² meter.

OMNI+ Compound (C²) Water Meter

1-1/2", 2", 3", 4", 6", 8" and 10"

Strainer

The OMNI+ C² with the AWWA compliant "V" shaped strainer uses a stainless steel screen along with Floating Ball Technology (FBT). This creates a design that greatly improves accuracy, even in difficult settings. A removable strainer cover permits easy access to the screen for routine maintenance.

AMR/AMI Systems

Meters and Electronic Registers are compatible with current Sensus AMR/AMI systems and other AMI communication systems that use the Sensus UI1203 protocol.

Maintenance

The OMNI+ C² meter is designed for easy maintenance. Should any maintenance be required, the measuring chamber and/or strainer cover can be removed independently. Replacement parts or complete measuring chambers are available for repairs. OMNI+ C² replacement measuring chambers may also be utilized to upgrade some third-party meters to achieve increased accuracy and extended service life.

Data Logging

The OMNI+ C² meter logs 180 days of hourly consumption data.

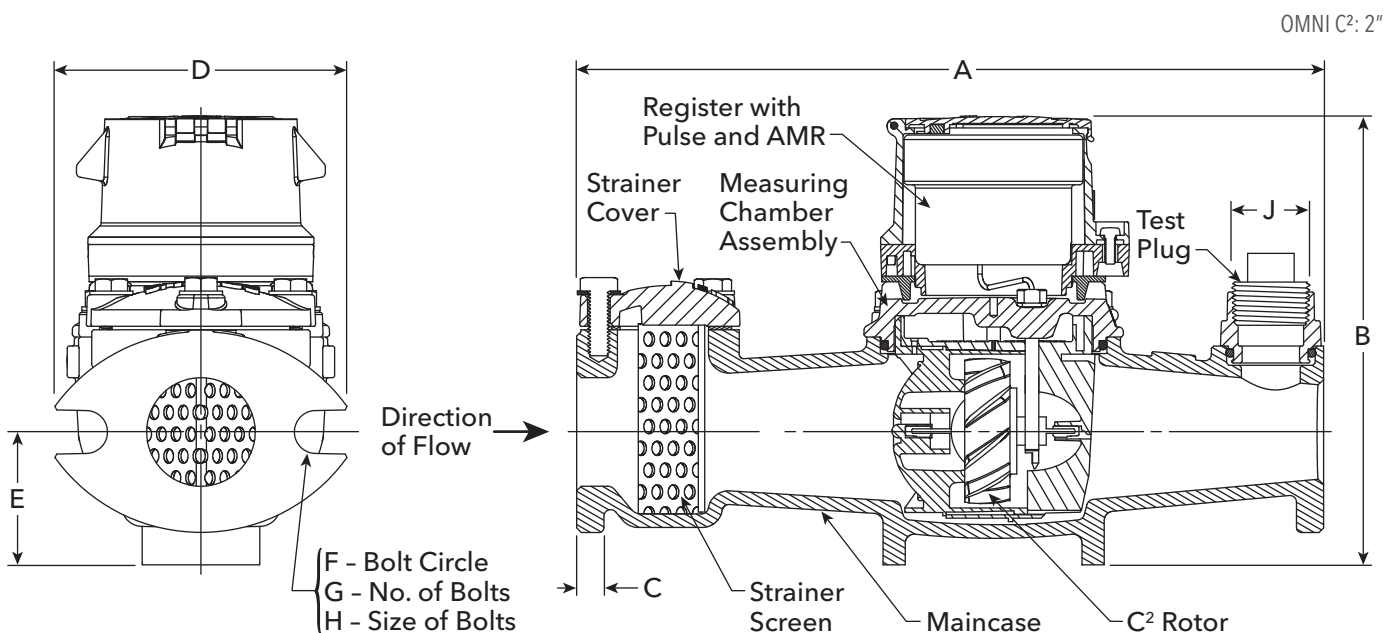
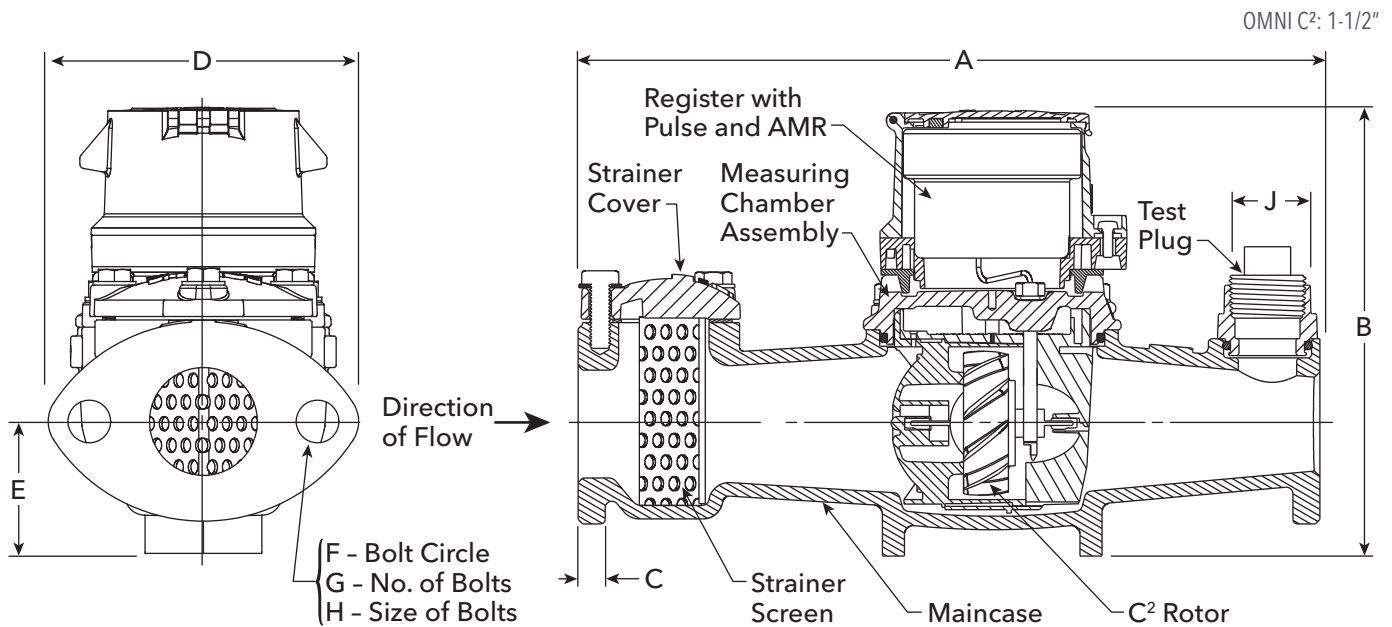

OMNI+ Compound (C²) Water Meter

1-1/2", 2", 3", 4", 6", 8" and 10"

OMNI C²: 3" - 6"

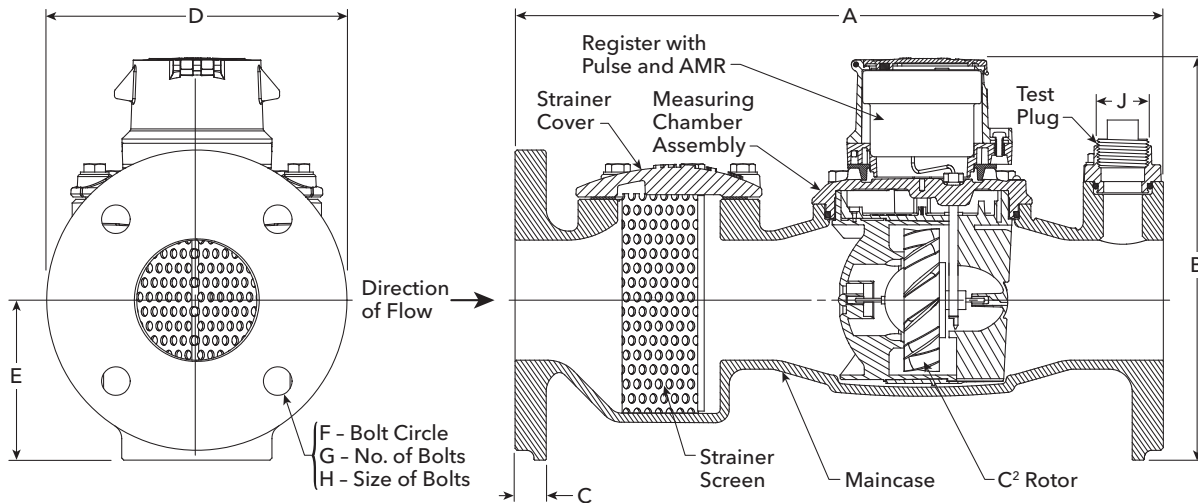

OMNI C²: 8" - 10"

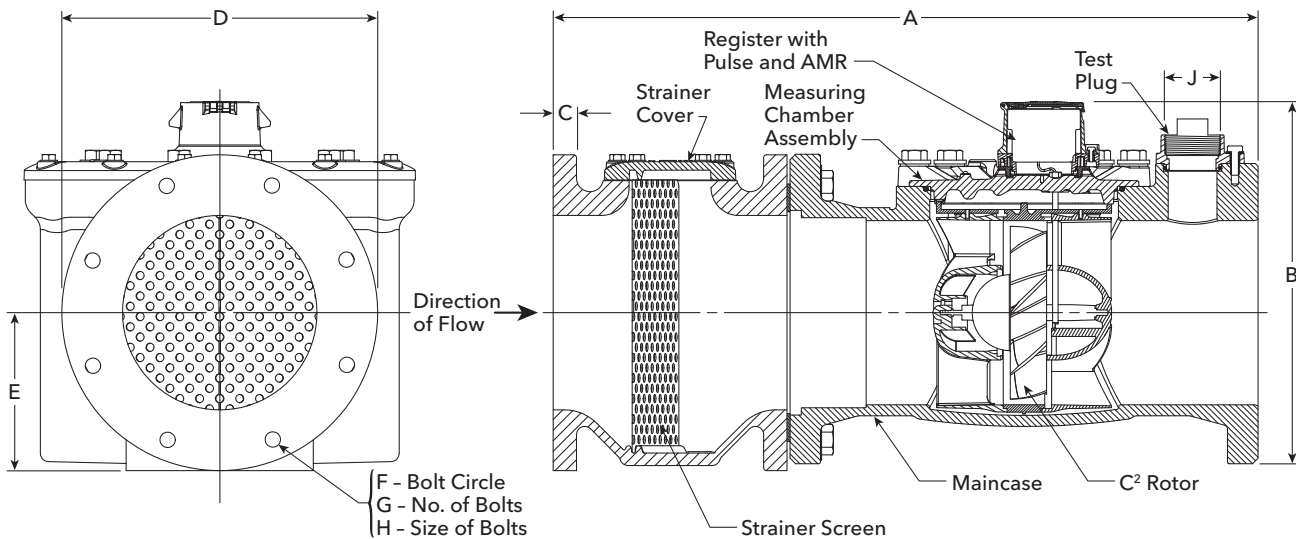

DIMENSIONS AND NET WEIGHTS

Meter and Pipe Size	Normal Operating Range		Connections	A	B	C	D	E	F	G	H	J	Net Weight	Shipping Weight
1-1/2" DN 40 mm	.5 gpm .11 m ³ /hr	200 gpm 45 m ³ /hr	Flanged	13" 330 mm	8-1/2" 216 mm	15/16" 24 mm	5-7/16" 138 mm	2-5/16" 59 mm	4" 102 mm	2	5/8" 16 mm	1" 25 mm	18.8 lb 8.53 kg	22.5 lb 10.20 kg
2" DN 50 mm	.5 gpm .11 m ³ /hr	200 gpm 45 m ³ /hr	Flanged	15-1/4" 387 mm	8-1/2" 216 mm	1" 25 mm	5-3/4" 146 mm	2-5/16" 59 mm	4-1/2" 114 mm	2	5/8" 16 mm	1" 25 mm	25.4 lb 11.5 kg	32.5 lb 14.74 kg
3" DN 80 mm	1 gpm .23 m ³ /hr	500 gpm 114 m ³ /hr	Flanged	17" 432 mm	11-1/4" 286 mm	3/4" 19 mm	7-7/8" 200 mm	4-1/8" 105 mm	6" 152 mm	4	5/8" 16 mm	1" 25 mm	45 lb 20.41 kg	48.0 lb 21.8 kg
4" DN 100 mm	1.5 gpm .34 m ³ /hr	1000 gpm 227 m ³ /hr	Flanged	20" 508 mm	11-3/4" 299 mm	15/16" 24 mm	9-1/8" 232 mm	4-3/4" 121 mm	7-1/2" 191 mm	8	5/8" 16 mm	1-1/2" 38 mm	64.9 lb 29.44 kg	72.8 lb 33.02 kg
6" DN 150 mm	3 gpm .68 m ³ /hr	2000 gpm 454 m ³ /hr	Flanged	24" 610 mm	14" 355 mm	15/16" 24 mm	11" 279 mm	5-3/4" 146 mm	9-1/2" 241 mm	8	3/4" 19 mm	1-1/2" 38 mm	130 lbs 59.0 kg	155 lb 70.3 kg
8" DN 200 mm	4 gpm .91 m ³ /hr	2700 gpm 614 m ³ /hr	Flanged	30-1/8" 765 mm	16-1/2" 419 mm	11/16" 17 mm	13-1/2" 343 mm	6-3/4" 172 mm	11-3/4" 298 mm	8	3/4" 19 mm	2" 51 mm	471 lb 214 kg.	521 lb 236 kg
10" DN 250 mm	5 gpm 1.1 m ³ /hr	4000 gpm 908 m ³ /hr	Flanged	41-1/8" 1045 mm	19" 483 mm	11/16" 17 mm	16" 406 mm	8-1/2" 216 mm	14-1/4" 362 mm	12	7/8" 22 mm	2" 51mm	685 lb 311 kg	745 lb 338 kg

OMNI+ Compound (C²) Water Meter

1-1/2", 2", 3", 4", 6", 8" and 10"

SPECIFICATIONS

Service	Measurement of potable and reclaim water. IP68 Rated. Storage temperature: -22 °F (-30 °C) to 155 °F (68.3 °C)	Operating temperatures: Air: -22 °F (-30 °C) to 150 °F (65.6 °C) Water: 33 °F (0.6 °C) to 80 °F (26.7 °C)
Operating Range (100% ± 1.5%)	1-1/2": 0.5 - 200 gpm (0.11 - 45 m ³ /hr) 2": 0.5 - 200 gpm (0.11 - 45 m ³ /hr) 3": 1.0 - 500 gpm (0.23 - 114 m ³ /hr) 4": 1.5 - 1000 gpm (0.34 - 227 m ³ /hr)	6": 3 - 2000 gpm (0.68 - 454 m ³ /hr) 8": 4 - 2700 gpm (0.91 - 614 m ³ /hr) 10": 5 - 4000 gpm (1.1 - 908 m ³ /hr)
Low flow (95% - 101.5%)	1-1/2": 0.25 gpm (.06 m ³ /hr) 2": 0.25 gpm (.06 m ³ /hr) 3": 0.5 gpm (0.11 m ³ /hr) 4": 0.75 gpm (0.17 m ³ /hr)	6": 1.5 gpm (0.34 m ³ /hr) 8": 2.5 gpm (0.57 m ³ /hr) 10": 3.5 gpm (0.8 m ³ /hr)
Maximum Continuous Operation	1-1/2": 160 gpm (36 m ³ /hr) 2": 160 gpm (36 m ³ /hr) 3": 400 gpm (91 m ³ /hr) 4": 800 gpm (182 m ³ /hr)	6": 1600 gpm (363 m ³ /hr) 8": 2700 gpm (614 m ³ /hr) 10": 4000 gpm (908 m ³ /hr)
Maximum Intermittent Operation	1-1/2": 200 gpm (45 m ³ /hr) 2": 200 gpm (45 m ³ /hr) 3": 500 gpm (114 m ³ /hr) 4": 1000 gpm (227 m ³ /hr)	6": 2000 gpm (454 m ³ /hr) 8": 3400 gpm (773 m ³ /hr) 10": 5000 gpm (1136 m ³ /hr)
Pressure Loss	1-1/2": 6.9 psi @ 160 gpm (0.48 bar @ 36 m ³ /hr) 2": 4.3 psi @ 160 gpm (0.30 bar @ 36 m ³ /hr) 3": 3.2 psi @ 400 gpm (0.22 bar @ 91 m ³ /hr) 4": 6.4 psi @ 800 gpm (0.44 bar @ 182 m ³ /hr)	6": 5.5 psi @ 1600 gpm (0.38 bar @ 363 m ³ /hr) 8": 4 psi @ 2700 gpm (0.28 bar @ 614 m ³ /hr) 10": 4.5 psi @ 4000 gpm (0.31 bar @ 908 m ³ /hr)
Maximum Operating Pressure	200 PSI (13.8 bar)	
Flange Connections	U.S. ANSI B16.1 / AWWA Class 125	
Test Ports	NPT	
Register	Fully electronic sealed register with programmable registration (Gal. / Cu.Ft. / Cu. Mtr. / Imp. Gal. / Acre Ft.)	Programmable AMR/AMI reading and pulse outputs Guaranteed 10-year battery life
NSF Approved Materials	Maincase: Coated Ductile Iron Measuring Chamber: Thermoplastic Rotor "Floating Ball": Thermoplastic Radial Bearings: Hybrid Thermoplastic Thrust Bearings: Sapphire/Ceramic Jewel	Magnets: Ceramic Strainer Screen: Stainless Steel Strainer Cover: Coated Ductile Iron Test Plug: Stainless Steel

OMNI+ Compound (C²) Water Meter

1-1/2", 2", 3", 4", 6", 8" and 10"

Headloss Curves

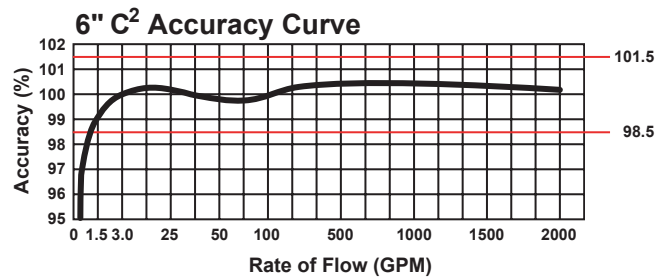
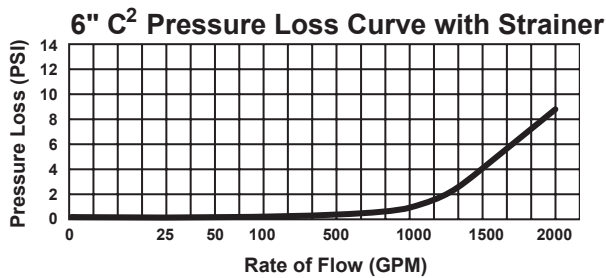
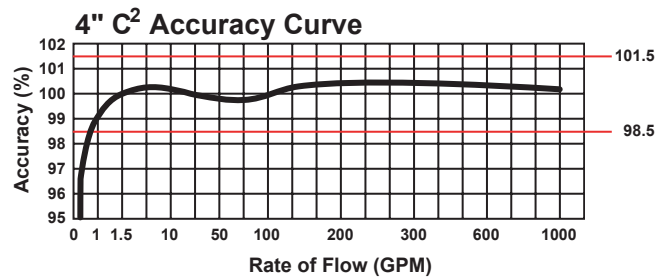
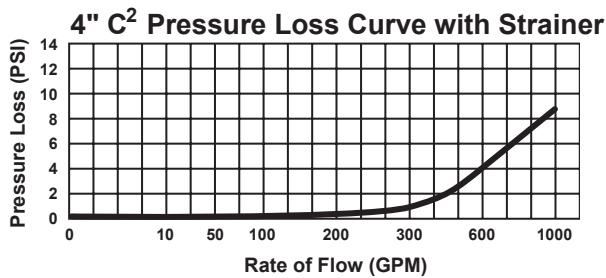
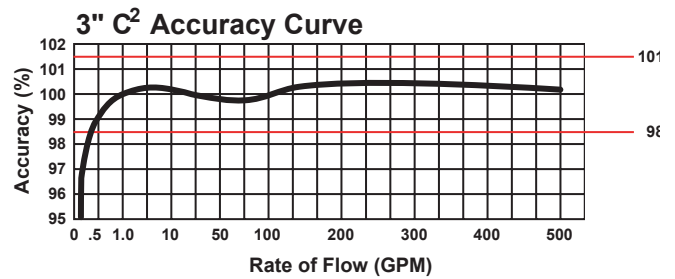
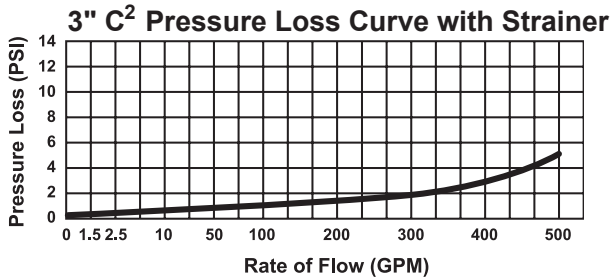
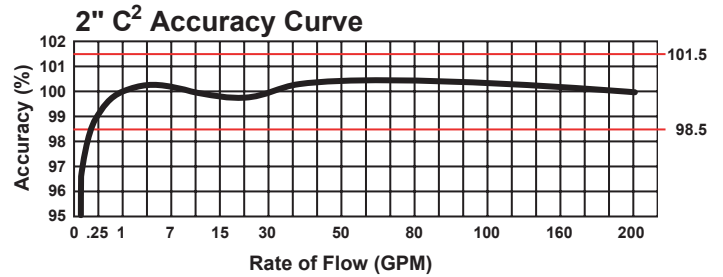
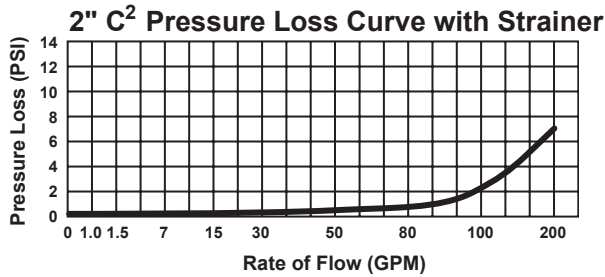
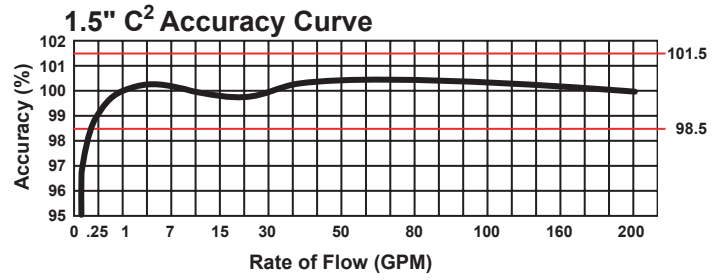
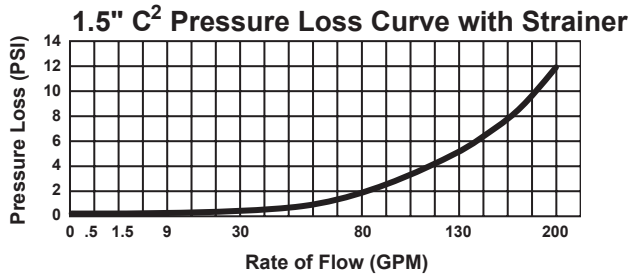

OMNI+ Compound (C²) Water Meter

1-1/2", 2", 3", 4", 6", 8" and 10"

Headloss Curves

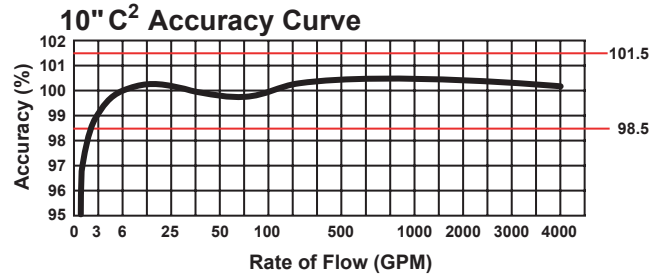
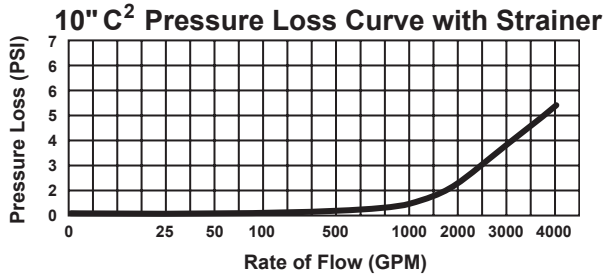
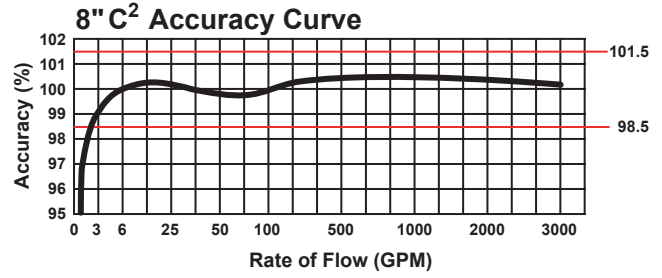
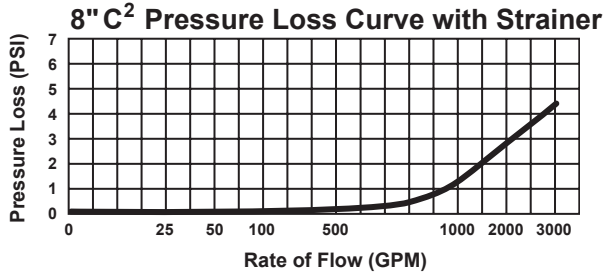

Xylem.com | Sensus.com

SENSUS | 637 Davis Drive | Morrisville, NC 27560 | 800.638.3748

©2023 Sensus. All products purchased and services performed are subject to Sensus' terms of sale, available at either sensus.com/TC or 1-800-638-3748. Sensus reserves the right to modify these terms and conditions in its own discretion without notice to the customer. The Sensus logo is a registered trademark of Sensus.

This document is for informational purposes only, and SENSUS MAKES NO EXPRESS WARRANTIES IN THIS DOCUMENT. FURTHERMORE, THERE ARE NO IMPLIED WARRANTIES, INCLUDING WITHOUT LIMITATION, WARRANTIES AS TO FITNESS FOR A PARTICULAR PURPOSE AND MERCHANTABILITY. ANY USE OF THE PRODUCTS THAT IS NOT SPECIFICALLY PERMITTED HEREIN IS PROHIBITED.