

90-1874

TABLE OF CONTENTS

Safety Instructions	2	Determine Ventilation Requirements	9
Introduction and Compliance Statement	3	Calculating Airflow Requirement	9
Specifications	3	Determine Outdoor Air (CFM) Delivery Rate	9
Set Up Ventilator for Installation	4	System Set Up and Checkout	10
Duct Collars	4	Installer Test Mode	11
Control Location	5	Start Up and Sequence of Operation	12
Location Considerations	5	Adjusting Ventilation Time After Initial Set Up	12
Drain Installation	6	Maintenance	13
Leveling	7	Clean or Replace the Air Filter	13
Condensate Pan, Condensate Pump and Float Switch	7	Check the Drain	13
Ducting and Wiring	8	Troubleshooting	14
Ducting	8	Table 4 – Diagnostic Codes	14
Wiring	8	Table 5 – Troubleshooting Guide	15
		Service Parts	16

READ AND SAVE THESE INSTRUCTIONS

SAFETY INSTRUCTIONS

WARNING

1. 120 Volts may cause serious injury from electric shock. Disconnect electrical power before starting installation or servicing. Leave power disconnected until installation/service is completed.
2. Dropping may cause personal injury or equipment damage. Handle with care and follow installation instructions.
3. Sharp edges may cause serious injury from cuts. Use care when cutting plenum openings and handling duct work.

CAUTION

1. Read all instructions before beginning installation.
2. Improper installation may cause property damage or injury. Read instructions before installation, service or maintenance.
3. Do not use in pool applications. Pool chemicals can damage the dehumidifier.
4. Do not use solvents or cleaners on or near the circuit board. Chemicals can damage circuit board components.
5. Wait 24 hours before running the unit if it was not shipped or stored in the upright position
6. Do not use dehumidification to prevent window condensation in the winter. To address window condensation, use ventilation to lower indoor humidity in the winter.
7. This appliance is not intended for use by persons(including children) with reduced physical, sensory, or mental capabilities, or lack of experience and knowledge, unless they have been given supervision or instruction concerning the use of this appliance by a person responsible for their safety.
8. Children should be supervised to ensure that they do not play with the appliance.
9. If the supply cord is damaged, it must be replaced by a special cord or assembly available from the manufacturer or its service agent.

INTRODUCTION AND COMPLIANCE STATEMENT

The Model 8192A Ventilator with Dehumidification is designed to bring outdoor air into today's efficiently designed homes while removing moisture from the air. Simply duct the inlet of the ventilator to an outdoor air intake and duct the discharge to the return side of the HVAC system. Plug the unit in, set the amount of needed ventilation and set the humidity limit.

High temperature limits can be set on the control to prevent bringing in outdoor air during the hottest period of the day. The built in control will automatically compensate for the ventilation time that is missed by bringing in additional outdoor air during cooler periods of the day. Compliance with the requirements of ASHRAE 62.2-2010 is met as the control adds ventilation time as needed to account for the fractional on-time and effectiveness of the ventilation schedule. The control will also ensure that ventilation occurs no less than one hour of every four. When properly installed and set, the Model 8192A Ventilator with Dehumidification will meet the mechanical ventilation requirements of:

- Energy Star Certified Homes, Version 3
- EPA Indoor airPLUS, Version 1
- 2012 International Residential Code (IRC)
- 2012 International Energy Conservation Code (IECC)

SPECIFICATIONS

	Model 8192A	
Unit Weight	64 lbs.	
Shipping Weight	82 lbs.	
Moisture Removal Capacity	100 pints per day @ 280 CFM 80°F, 60%RH Conditions	
Power	115 VAC, Single Phase, 60Hz 6.9A operating current @ 80°F, 60%RH	
Inlet Air Conditions	Ventilation: 40°F – 140°F, 0%RH – 99%RH (non-condensing) Dehumidification: 50°F – 104°F, 40°F dew point minimum	
Filter	MERV 8, washable	
Airflow	External Static Pressure ("w.c.)	Airflow (CFM)
	0.0	280
	0.2	245
	0.4	210
	0.6*	175

*Maximum design external static pressure.

NOTE: Rated capacity and current draw measured at 80°F/60% RH inlet conditions at 0.0 external static pressure.

SET UP VENTILATOR FOR INSTALLATION

⚠ IMPORTANT: Cut the strap securing the compressor shipping support bracket and remove the strap and shipping bracket. See **Figure 1**.

FIGURE 1 – Remove Shipping Bracket

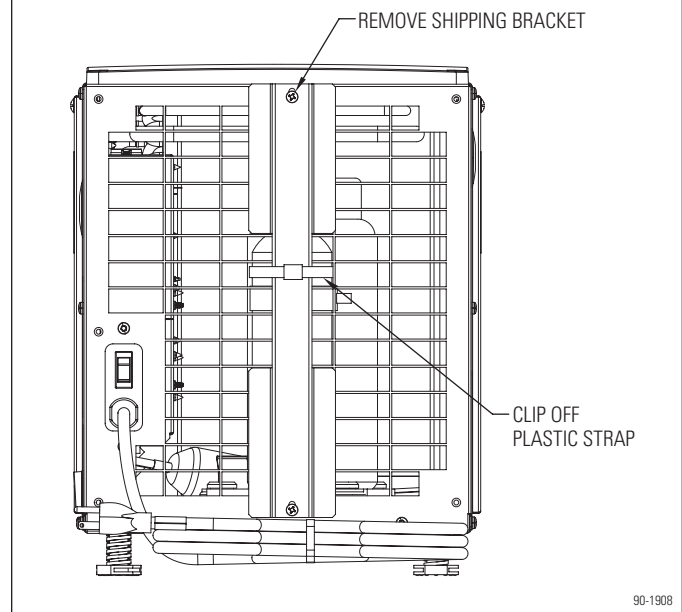

DUCT COLLARS

STANDARD BASEMENT AND ATTIC INSTALLATIONS (FULLY DUCTED)

- Use the screws in the parts bag to attach the duct collars to the inlet and outlet of the ventilator. The outlet collar has a backflow damper.
- The outlet duct collar may be attached to the top or end of the unit. Move the outlet cover to the location not being used. See **Figure 2**.
- Make sure there are no bends in the ductwork coming off the outlet for a minimum of 4". This will ensure that the ductwork will not interfere with the backflow damper function.

FIGURE 2 – Duct Collar Locations

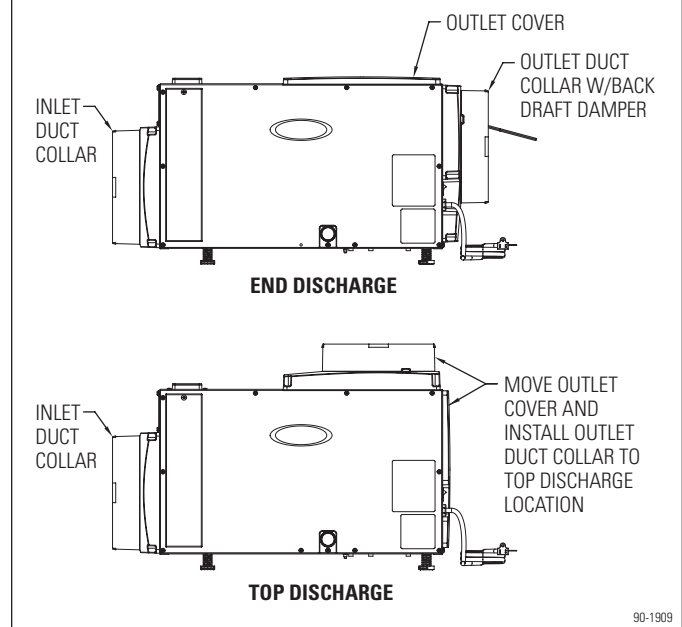

CONTROL LOCATION

The on-board control can be located on the top of the ventilator or can be relocated to the front of the ventilator.

To move the control:

1. Remove the front control panel cover.
2. Remove the filter access door and filter.
3. Detach the on-board control by removing the four (4) screws around the control. **NOTE:** Use one hand to support the bottom of the on-board control when removing.
4. Keep the control in the unit and relocate to the front access hole.
5. Secure the control with the same four screws used to attach the control to the top of the unit.
6. Secure the control panel cover to the top of the unit.

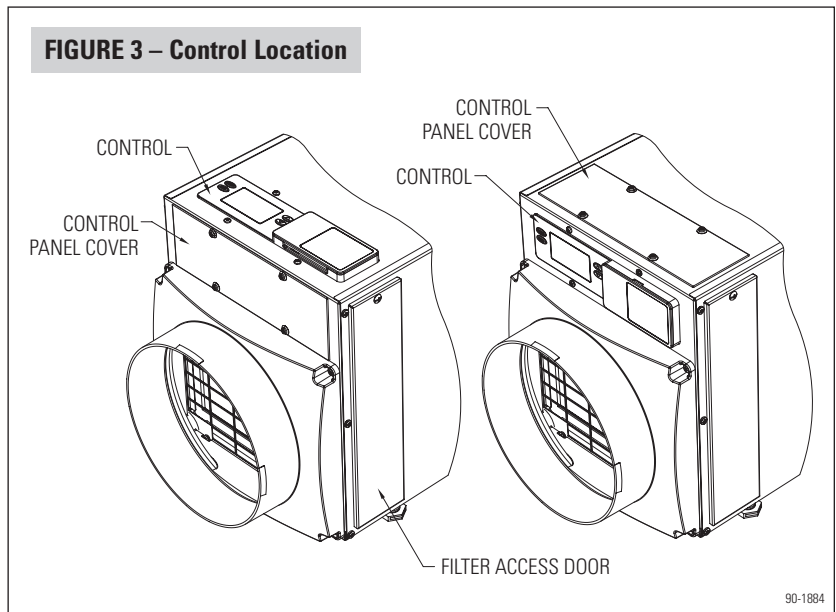

LOCATION CONSIDERATIONS

- Allow sufficient clearance for filter removal and to prevent airflow obstruction
- Electrical service access will require the removal of the side panel shown. Allow sufficient space for service on this side of the unit.
- For attic installations, it is recommended that the ventilator be suspended.
- Always install the ventilator in a condensate pan when locating in or over a finished space.

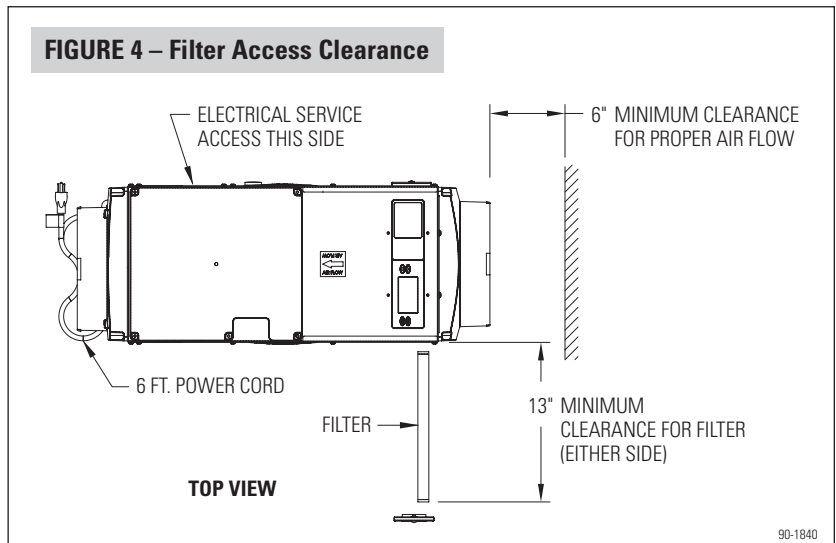

DRAIN INSTALLATION

The drain outlet on the dehumidifier can be hard piped using a 3/4" PVC Slip x 3/4" MNPT fitting and 3/4" nominal drain tubing or the provided 3/4" MNPT x 3/4" hose barb fitting. 3/4" clear PVC tubing can be used to drain the dehumidifier. Always maintain a constant downward slope from the dehumidifier to the drain and do not allow soft tubing to curl up which may result in air lock.

NOTE: PTFE thread seal tape is recommended for the threaded connection and **hand tighten only**. If hard pipe is used, PVC primer and cement is recommended for the slip fit connection. Remove drain insert before priming and gluing in the PVC fitting. Replace drain insert after PVC glue has fully dried.

⚠ CAUTION

Do not damage drain cover. The drain cover is a critical feature of the dehumidifier drain management system.

⚠ WARNING

Running the dehumidifier without the drain insert can lead to condensate leaks. See **Figure 5**.

FIGURE 5 – Drain Insert

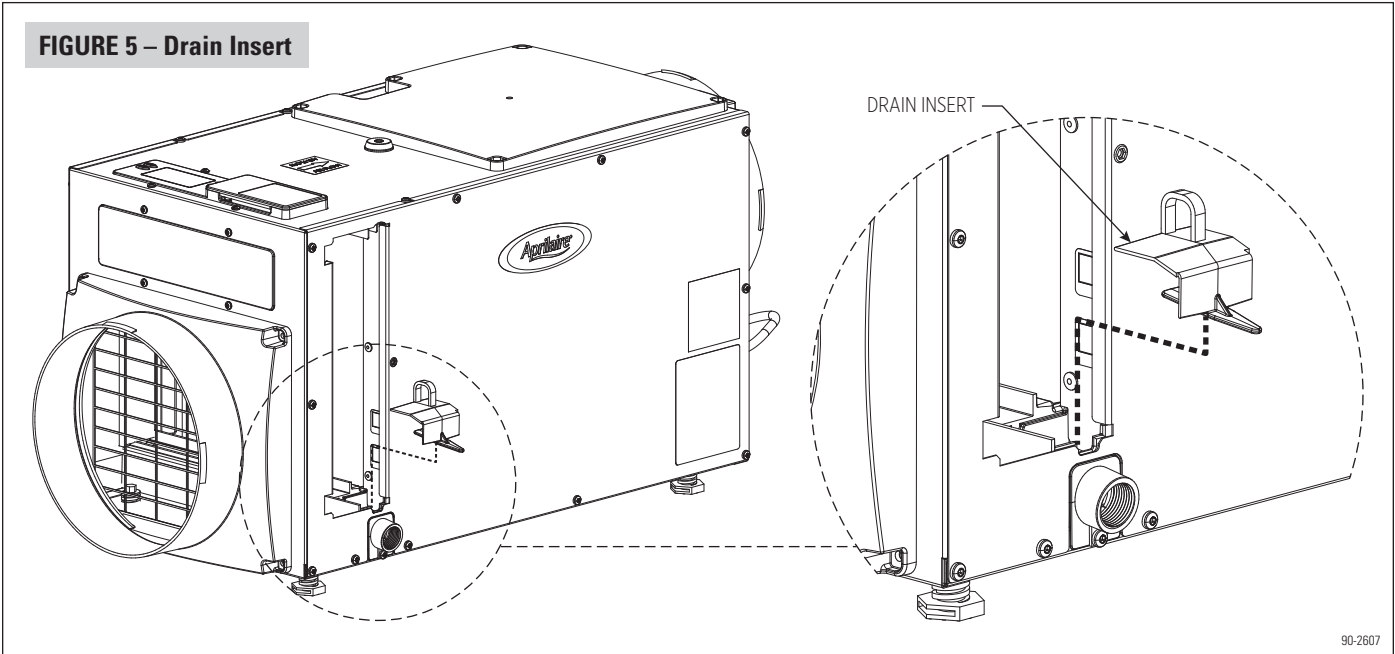

90-2607

LEVELING

The feet can be adjusted to level the unit and accommodate drain fittings and secondary condensate pans as required. Refer to top mounted bubble level and adjust feet until bubble is within the outer circle. **Leveling is required** to ensure proper drainage from the dehumidifier. See **Figure 6**.

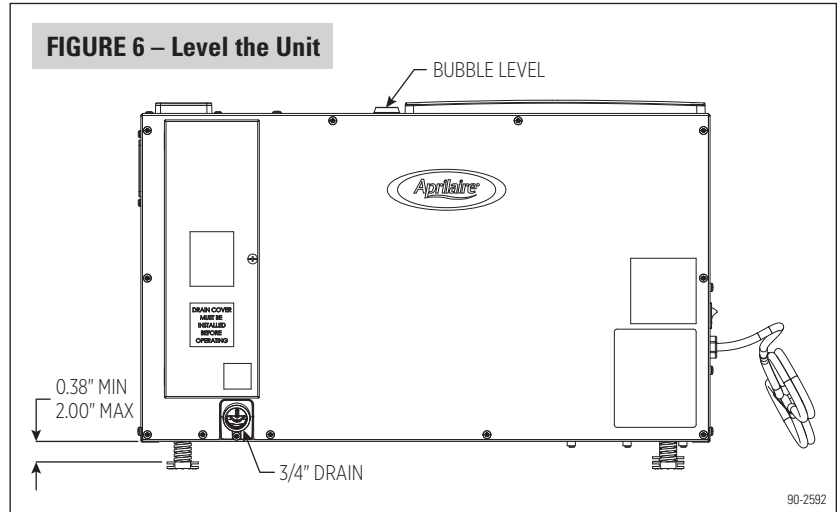

CONDENSATE PAN, CONDENSATE PUMP AND FLOAT SWITCH

Always install the ventilator in a condensate pan when locating in or above a finished space. Adhere to local codes regarding draining of the condensate pan. If a condensate pump is needed, install it in the condensate pan as well.

Install a condensate overflow safety switch (i.e. float switch) in the condensate pan, remove the factory installed jumper wire between the Float Switch terminals on the control and wire the float switch to the ventilator as shown in **Figure 7**. Overflow safety switches on condensate pumps can be wired to the Float Switch terminals in a similar fashion.

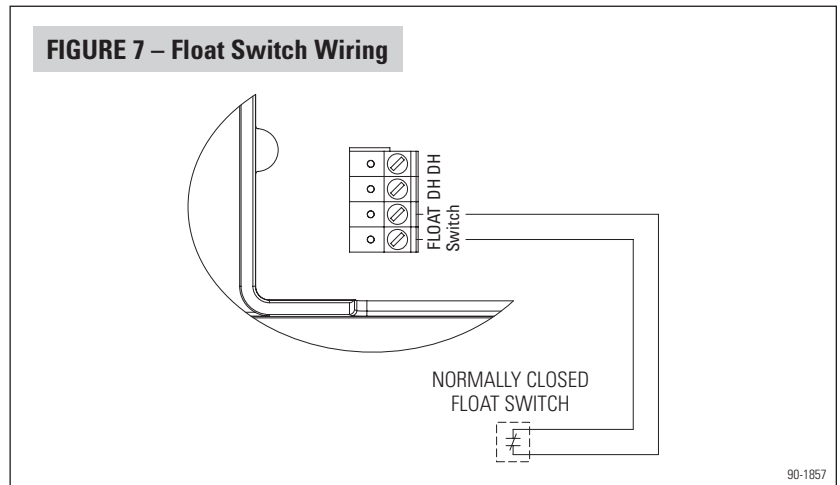

DUCTING AND WIRING

DUCTING

Install ducting as shown in **Figure 8**. A 6" diameter intake duct is usually sufficient, but a larger intake duct, or multiple 6" intake ducts can be used if added ventilation flow is needed.

A normally closed damper like the Aprilaire Model 6506 needs to be installed in the intake duct to comply with Energy Star Certified Homes requirements.

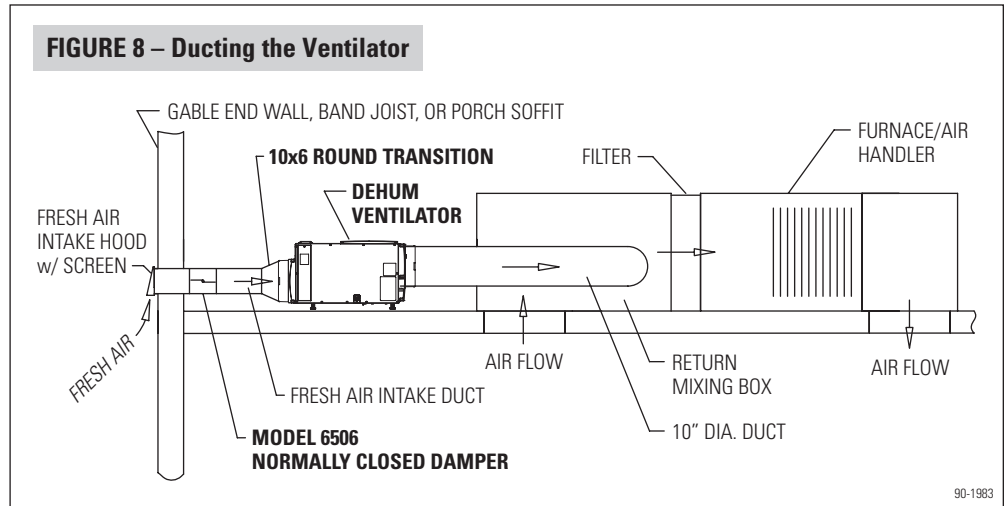

WIRING

Wire the control to the HVAC system as show in **Figure 9**. Wiring to the HVAC system allows the ventilator to turn on when the HVAC system is running for improved circulation of the outdoor air, and to take advantage of the latent capacity of the air conditioning.

The ventilation output of a thermostat can wired to the DH terminals of the Model 8192A to put control of ventilation in the living space. Aprilaire thermostat models with a ventilation output include: 8840M, 8840, 8920W, 8830, 8910W, 8910, 8820, 8620W and 8620. Note that an outdoor temperature sensor (included with all models) must be wired to the thermostat to take full advantage of all ventilation features.

Wiring to the Rf terminal of the ventilator is optional. Wiring as shown allows the fresh air brought in by the ventilator to be distributed to the entire home by the HVAC system fan when it would not be otherwise running.

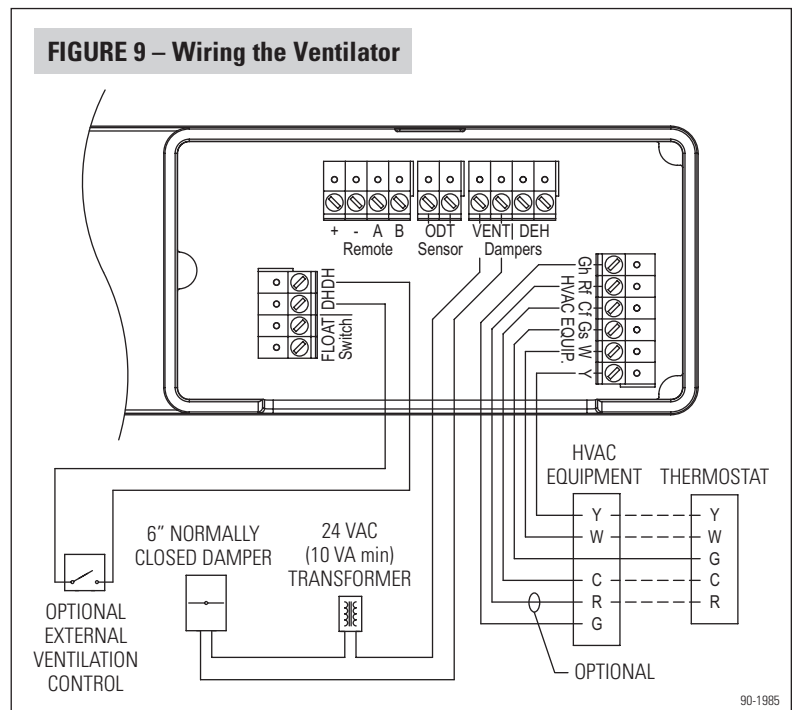

DETERMINE VENTILATION REQUIREMENTS

CALCULATING AIRFLOW REQUIREMENT

1. The MINIMUM ventilation requirement is calculated using ASHRAE 62.2-2010.

$$\text{ASHRAE Airflow in CFM} = [\text{House Area in Sq. Ft.} \times 0.01] + [(\text{Number of Bedrooms} + 1) \times 7.5]$$

NOTE: Use 'Number of Bedrooms + 1' or 'Number of Occupants', whichever is larger.

2. **Table 1** shows the calculated airflow values to the nearest 5 CFM.

3. Record the required CFM. _____

House Sq. Ft.	Number of Bedrooms					
	2	3	4	5	6	7
1000	35	40	50	55	65	70
1500	40	45	55	60	70	75
2000	45	50	60	65	75	80
2500	50	55	65	70	80	85
3000	55	60	70	75	85	90
3500	60	65	75	80	90	95
4000	65	70	80	85	95	100
4500	70	75	85	90	100	105
5000	75	80	90	95	105	110

DETERMINE OUTDOOR AIR (CFM) DELIVERY RATE

Measure the outdoor air flow (CFM) through the duct that is bringing in only outdoor air. Use the CFM Delivered along with the CFM required to find the Cycle Time per hour setting from **Table 2**. For example if the ventilator is providing 120 CFM, and the requirement is 70 CFM, set the time to 35 minutes.

CFM Delivered	CFM Required									
	20	30	40	50	60	70	80	90	100	110
60	20	30	40	50	60					
80	15	25	30	40	45	55	60			
100	15	20	25	30	35	40	50	55	60	
120	15	15	20	25	30	35	40	45	50	55
140	15	15	15	20	25	30	35	40	45	50
160	15	15	15	20	25	25	30	35	40	45
180	15	15	15	20	20	25	30	30	35	40
200	15	15	15	15	20	25	25	30	30	35
220	15	15	15	15	20	20	20	25	30	30

SYSTEM SET-UP & CHECKOUT

1. Check all wiring.
2. Make sure the wire access cover has been snapped back onto the on-board control.
3. Plug unit in and turn power switch to ON.
4. The on-board control screen should display OFF.

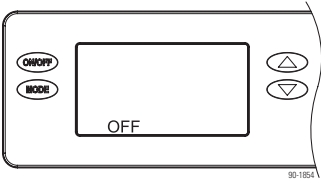

NOTE: If the display backlight is not on, the first button press (any button) will only turn on the backlight. Press the button a second time to achieve function.

5. Hold the MODE button on the on-board control for 3 seconds to enter the Installer Set-up Menu.
6. Navigate through the following screens to set up the ventilator for the installed application.
Use the UP or DOWN arrows to select items and use MODE to switch to the next set-up option. To exit installer set-up, all options must be scrolled through using the MODE button.

7. After the installer set up options have been completed, DONE will blink for 3 seconds and the control will return to the OFF screen.

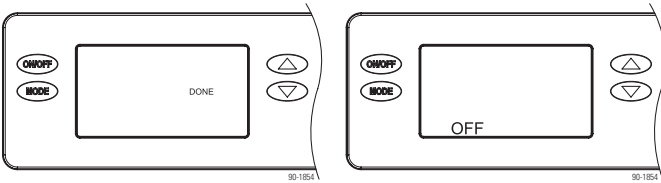

External Ventilation Control Option

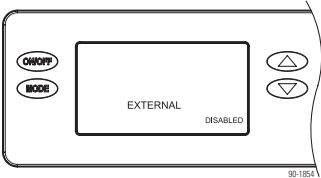

Ventilation settings are adjusted on the 8192A (on-board control) with External Control **DISABLED**.

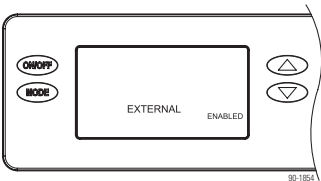

An external control such as a thermostat can be used to turn ventilation on and off with External Control **ENABLED**. The Remote Control option is not available when External Control is enabled.

Model 76 Remote Control Option

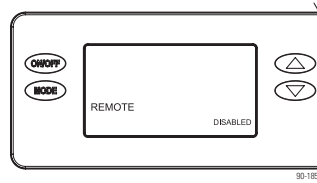

If using the control on the ventilator, keep this feature **DISABLED**.

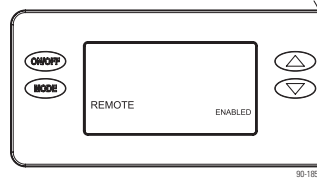

If using the Model 76 Remote Control to adjust the humidity setting, this feature should be **ENABLED**.

On-Board Ventilation Control

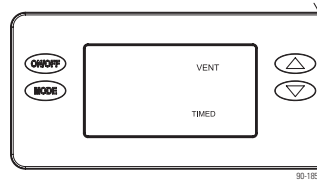

If ventilating based on time only (no outdoor temperature restrictions), press MODE at the VENT TIMED screen to go to ventilation time selection screen.

If ventilating with outdoor temperature restrictions, use the UP arrow to go from VENT TIMED to VENT AUTO –B and then the UP/DOWN arrows to select the desired ventilation mode, B, C, or D. Press MODE to go to the ventilation time selection screen.

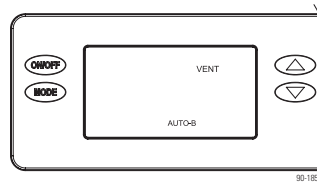

Vent-Auto-B: Ventilation prevented when outdoor temperature is above 105°F.

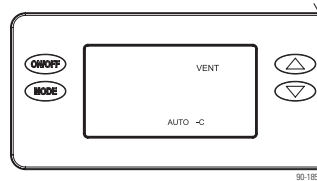

Vent-Auto-C: Ventilation prevented when outdoor temperature is above 100°F.

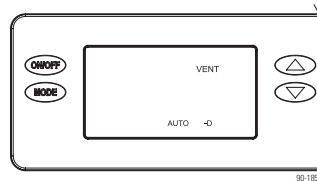

Vent-Auto-D: Ventilation prevented when outdoor temperature is above 95°F.

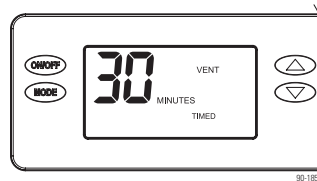

Press the UP or DOWN arrows to adjust the ventilation time per hour from 0 to 60 minutes. After selecting time, press MODE to go to the ZONE screen selections.

DEH W/AC

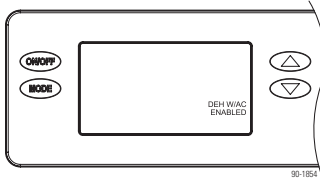

To allow the ventilator to dehumidify during active air conditioning, select **ENABLED** and press MODE.

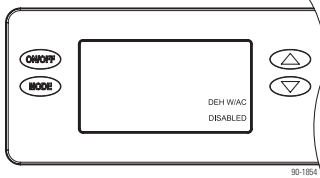

To disable the ventilator from dehumidifying when the air conditioning is on, select **DISABLED** and Press MODE.

RH Offset

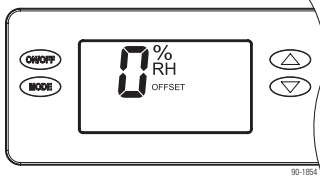

An offset can be applied to the on-board humidity reading to avoid discrepancies with other humidity measuring devices in the home. Use the UP/DOWN arrows to select an offset from -5% to 5%. Press MODE to exit the installer set-up screens.

Installer Test Mode

If everything is properly wired, the ventilator and all of the wired components will turn on and off during Installer Test Mode to demonstrate that all are properly operating. Installer Test Mode lasts for four (4) minutes. If the ON/OFF button is pressed during test mode, the ventilator will exit Installer Test Mode and return to the OFF screen.

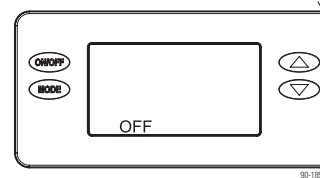

If the ventilator is not already OFF, press the ON/OFF button to turn it off.

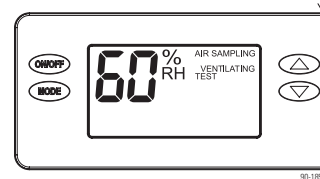

Press and hold the MODE and ON/OFF button for 3 seconds. The blower will start, the vent damper will open and the display will appear as shown.

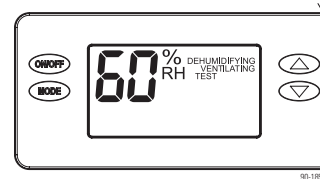

After three minutes the compressor will start and "AIR SAMPLING" will be replaced by "DEHUMIDIFYING".

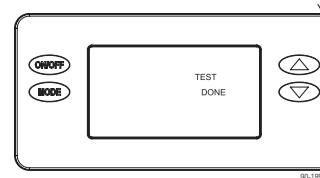

After one minute of compressor operation, all outputs will turn off and DONE will blink for 3 seconds and then return to the OFF screen.

START UP AND SEQUENCE OF OPERATION

Turn the ON/OFF switch ON, and turn on the control by pressing the ON/OFF button. The first press of any button only turns on the backlight, so the ON/OFF button may need to be pressed twice.

The display will show the humidity control setting – use the UP/DOWN buttons to adjust as needed. A setting of one (1) is less dry and a setting of seven (7) is more dry (see NOTE ON HUMIDITY CONTROL SETTING below). The ventilator will turn on and open the Vent Damper with the first call for heating (W) or cooling (Y) from the HVAC system. “VENTILATING” shows on the display when the ventilator is actively bringing in fresh air. For the first five minutes, the ventilator will measure the temperature of the incoming air, and if it is within the set limits, will stay on as long as the equipment is calling, or until the set amount of ventilation time has been met within the one hour cycle period. If the ventilation time is not met within the hour, the ventilator will turn on and open the damper at the end of the hour to ensure the ventilation time is met.

If the outdoor air temperature is above the high limit, ventilation will not occur during that one hour cycle period. The ventilation time missed will be added to a four hour cycle period so that the total ventilation will be met. The air temperature is measured once per hour to see if it is within range to be able to continue with ventilation. At the end of the four hour cycle period, the ventilator is turned on regardless of limits to ensure that the ventilator is on for at least one hour of every four. If the ventilation requirement has not been met in the first four hour cycle, the time will be added to the next four hour cycle, and so on until the cycle period reaches 24 hours. When the ventilation requirement can no longer be bypassed by limit, the ventilator will turn on and the ventilation requirement will be met.

If an external control has been wired to the thermostat, ventilation will occur only when a circuit is completed between the DH terminals of the Model 8192A control. The external control determines when ventilation occurs. Dehumidification of the incoming air is still controlled as described below even if an external control is determining when to ventilate.

Whenever the ventilator is on, the dew point of the incoming air is measured and if it is above the setting, the compressor will turn on and the air will be dehumidified. The compressor will run for a minimum of three minutes and must be off for a minimum of three minutes. “DEHUMIDIFYING” will show on the display of the ventilator whenever the compressor is running. If the ventilator is on with a cooling input (Y), the compressor will not turn on unless the feature to run dehumidification with the air conditioner has been enabled (see DEH W/AC in **SYSTEM SET UP & CHECKOUT** section on page 11).

NOTE ON HUMIDITY CONTROL SETTING: The humidity control setting corresponds to a dew point value. Dew point is used to control when the compressor turns on and off, and is a better measure than relative humidity (%RH) to ensure good humidity control without turning on the compressor more than is needed. Start with a humidity control setting of two (2) or three (3) and adjust as needed. The higher the humidity control setting, the more often the compressor will run. The table below can be used to relate the humidity control setting to the corresponding dew point and approximate resultant RH level in the home:

TABLE 3 – Humidity Control Setting				
Humidity Control Setting	Corresponding Dew Point	Resulting Indoor RH Level at Various Indoor Temperatures*		
		72°F	75°F	78°F
1	65°F	78%	70%	64%
2 (initial)	60°F	65%	59%	54%
3 (initial)	56°F	57%	51%	46%
4	52°F	49%	44%	40%
5	48°F	42%	38%	35%
6	44°F	36%	33%	30%
7	40°F	31%	28%	26%

*Resultant indoor RH levels do not account for internal humidity sources like cooking, showering, etc.

ADJUSTING VENTILATION TIME AFTER INITIAL SET UP USING ON-BOARD CONTROL

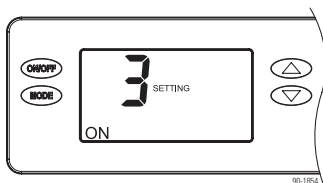

1. Press the UP or DOWN button to access the humidity control setting screen.

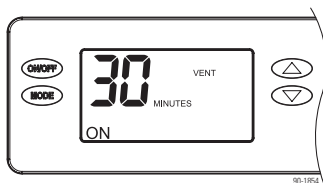

2. Press the MODE button to toggle to the VENT TIME setting.
3. Press the UP or DOWN button to adjust the ventilation time (minutes). After adjusted, press nothing else; the screen will return to home screen after three (3) seconds.

MAINTENANCE

CLEAN OR REPLACE THE AIR FILTER

After initial installation the air filter should be checked and cleaned every 6 months. The CLEAN FILTER service reminder will display on the on-board control screen every 6 months. To clear the service message, press the UP and DOWN arrows simultaneously for 3 seconds.

Filter Cleaning Procedure

1. Turn the ON/OFF switch OFF.
2. Remove the filter access door from either side of the ventilator.
3. Slide the filter out of the ventilator.
4. Flush the filter with warm water and a mild detergent solution.
5. Shake off the excess water from the filter.
6. Replace the filter, making sure the filter is secured in both the top and bottom filter rails.
7. Replace the filter access door.
8. Turn the ON/OFF switch ON.
9. Press the UP and DOWN buttons simultaneously for 3 seconds to clear the service message.

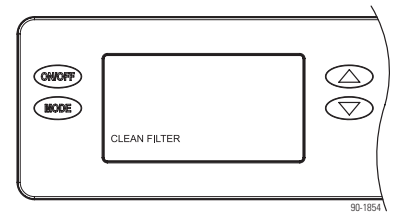

CHECK THE DRAIN

The drain should be checked annually to ensure there are no blockages or air lock in the drain system. If the unit is not draining properly, have it checked by a qualified service professional.

CAUTION

Do not use spray solvents or cleaners on or near the inlet side of the ventilator.
If desired, apply cleaner to a cloth and use to clean the cabinet.

TROUBLESHOOTING

Technical Support is available Monday through Friday, 7:00 a.m. to 5:00 p.m. CST, at (800) 334-6011. Use the guides on the following pages to identify and correct system faults. Contact Technical Support before replacing the unit or any components and for additional troubleshooting.

DIAGNOSTIC CODES

When an error occurs, the Diagnostic Code along with SERVICE REQUIRED will be displayed on the control screen.

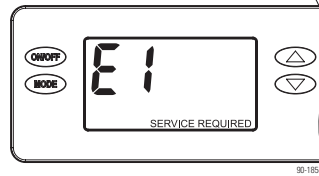

99-1854

TABLE 4 – Diagnostic Codes

Diagnostic Code	Failure Mode	Action	Reset
E1	Internal Humidity or Temperature Sensor Open or Shorted	<ol style="list-style-type: none"> 1. Check the connection between the sensor board and control board. 2. If connection okay, replace sensor board, Part No. 5460. 	Cycle Power
E2	High Refrigeration Pressure	<ol style="list-style-type: none"> 1. Verify that the fan works, the backflow damper swings freely and there is no blocked or restricted ductwork. 2. If the fault persists, call Technical Support. 	Cycle Power
E4	Loss of Capacity	<ol style="list-style-type: none"> 1. Cycle power to clear the diagnostic code. 2. Turn the control ON and use the DOWN button to adjust the humidity setting to one (1), then press MODE and adjust the Vent Time to 60. 3. After the blower starts, press and hold the UP and MODE buttons for three (3) seconds to enter the diagnostic display. In the diagnostic display, use the UP or DOWN button to cycle between the air temperature (value and "AIR SAMPLING" displayed), air relative humidity (value and "%RH" displayed) and the Frost sensor temperature (value only displayed). 4. The air temperature and Frost Sensor temperature should get to within a few degrees of each other in two to three minutes. If the Frost Sensor temperature is significantly lower than the air temperature, the Frost Sensor will need to be replaced – Part No. 5455. 5. If the sensor is OK turn up the humidity setting to seven (7) to turn on the compressor. Allow the compressor to run for 15 minutes and again check the air and Frost Sensor temperatures. The Frost Sensor temperature should be anywhere from 5°F (VERY hot/humid conditions) to 20°F (cooler/dryer conditions). 6. Call Technical Support if the Frost Sensor temperature did not get lower. 	Cycle Power
E5	High Temperature Thermistor Failure	<ol style="list-style-type: none"> 1. Remove the side panel to access the electrical service box inside the unit. 2. Remove the cover of the electrical service box. 3. Verify that the "Hi-Temp" sensor connector is seated completely on the circuit board pins. 4. Cycle power and if the diagnostic code does not clear, replace the sensor with Part No. 5456. 	Cycle Power
E6	Low Temperature Thermistor Failure	<ol style="list-style-type: none"> 1. Remove the side panel to access the electrical service box inside the unit. 2. Remove the cover of the electrical service box. 3. Verify that the "Frost" sensor connector is seated completely on the circuit board pins. 4. Cycle power and if the diagnostic code does not clear, replace the sensor with Part No. 5455. 	Cycle Power
E7	Float Switch Open	<ol style="list-style-type: none"> 1. Empty the condensate pan. 2. Check the float switch connection at the control board. 3. If not using a float switch, verify jumper is between float switch terminals on ventilator control board. 4. If the problem persists, replace the float switch. 	Self-Correcting
E8	Inlet Air Too Hot or Cold to Dehumidify	<ol style="list-style-type: none"> 1. This shows on the display only to inform the user. If the air coming into the dehumidifier is colder than 50°F, or warmer than 104°F, no moisture removal can take place. 2. Check that all ductwork is sealed. 	Self-Correcting

TABLE 5 – Troubleshooting Guide

Symptom	Possible Reason	Troubleshooting Procedure
Ventilator does not turn on/run.	No power to unit.	<ul style="list-style-type: none"> • Check that the ventilator is plugged in. • Check that the power switch is turned ON. • Check that the control is turned ON. • Check that the circuit breaker has not tripped.
Ventilator blower is running but with little or no airflow.	Pressure drop across ventilator is higher than 0.4" w.c.	<ul style="list-style-type: none"> • Check ventilator air filter and wash or replace. • Check for blocked duct work and clear. • Verify that the outlet collar with backflow damper is installed on the outlet side of the ventilator. • Check if backflow damper is blocked or stuck and remove obstruction.
Ventilator blower is running but compressor is not.	Float switch open.	<ul style="list-style-type: none"> • If float switch installed, check connections at control board and empty condensate pan. • If no float switch installed check that the jumper is installed at the float switch terminals on the control board.
	Coil frosting.	<ul style="list-style-type: none"> • Lack of or reduced airflow. Check ventilator air filter and wash or replace. • Check for blocked duct work. • Inlet air conditions below 60°F. Increase the humidity setting.
	Inlet air temperature is outside of the 50°F – 104°F range or the dew point is below 40°F and there is a demand for dehumidification.	<ul style="list-style-type: none"> • Verify all ductwork is properly sealed.
The ventilation damper does not open when the HVAC fan is active.	Cycle time has been met.	<ul style="list-style-type: none"> • The damper will not open if the Ventilation Time has already been met.
Ventilator is not draining properly.	Drain line blocked or unit not level.	<ul style="list-style-type: none"> • Verify that the unit is level. • Check the drain line blockages and for a continuous downward slope.
The HVAC fan turns on unexpectedly.	Ventilator is sampling or ventilation in progress.	<ul style="list-style-type: none"> • The ventilator will turn on the HVAC fan during air sampling or as needed to meet the ventilation time.
Ventilator is producing hot air.	Normal function.	<ul style="list-style-type: none"> • Air is reheated across the condenser coil, resulting in a temperature rise between inlet and outlet.
Display shows "OFF" even when the ON/OFF button is pushed.	A manual override switch has been installed and has turned the unit OFF.	<ul style="list-style-type: none"> • Turn the manual override switch OFF.

SERVICE PARTS

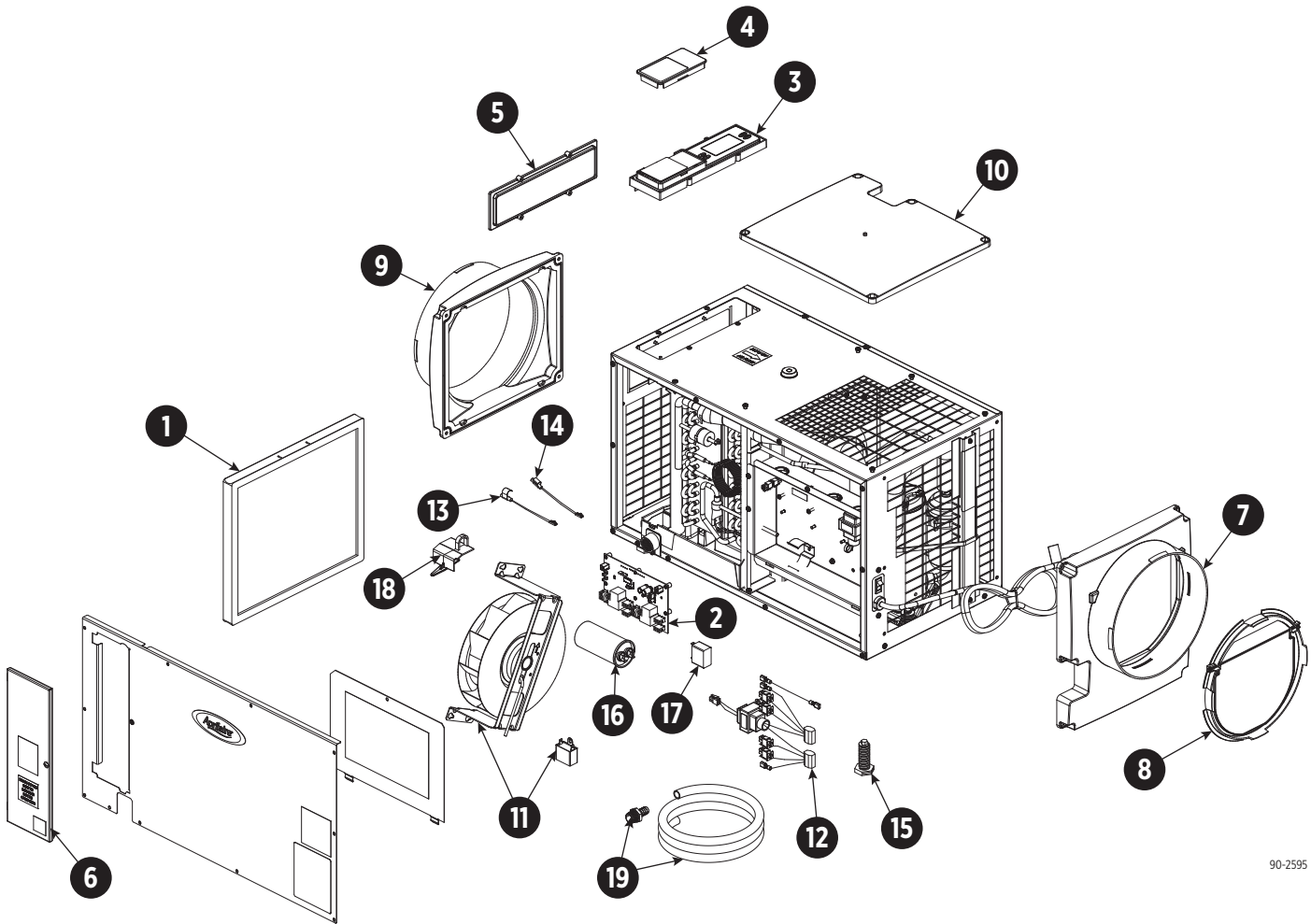

90-2595

No.	Part Description	Part No.
1	EZK Filter, 13.5" x 11.875" x 0.875"	5881
2	Internal Control Board, Deh	5444
3	User Interface Assembly, Deh	5564
4	Wiring Access Door, AA Deh	5446
5	Hole Cover, UI Ctrl, Deh	5447
6	Door, Filter Access, AA Deh	5882
7	Outlet Duct Panel, Deh	5449
8	Backflow Damper, 10", Deh	5450
9	Inlet Duct Panel, AA Deh	5451
10	Cover, Outlet, AA Deh	5452
11	Fan, 100pt Deh, with 12MFD Capacitor	5886

No.	Part Description	Part No.
12	Wire Harness, Power, Deh	5884
13	Sensor, Low Temperature, Deh	5455
14	Sensor, High Temperature, Deh	5456
15	Leveling Foot	5457
16	Capacitor, Run, 50µF	5594
17	Capacitor, 12MFD, 450VAC, 100pt Deh	5468
18	Drain Insert	5885
19	Drain Tube + Fitting	5692
NOT SHOWN		
	Wire Harness, 24V Deh w/ Vent*	5914

*Compatible with Model E100V and units equipped with the 8190FF FreshFlo vent kit.

AprilairePartners.com
 P.O. Box 1467
 Madison, WI 53701-1467
 800.334.6011 F: 608.257.4357
 Printed in USA
 ©2021 Aprilaire - Division of Research Products Corporation