

Contents

1. SAFETY PRECAUTIONS.....	1
1.1. IMPORTANT! Please read before starting.....	1
1.2. SPECIAL PRECAUTION.....	1
2. PRODUCT SPECIFICATION.....	2
2.1. Precaution for using R410A refrigerant.....	2
2.2. Special tools for R410A.....	2
2.3. Accessories.....	2
2.4. Cassette grille accessories.....	3
2.5. Pipe requirement.....	3
2.6. Electrical requirement.....	3
2.7. Optional parts.....	3
3. INSTALLATION WORK.....	4
3.1. Selecting an installation location.....	4
3.2. Installation dimensions.....	4
3.3. Installing the unit.....	4
3.4. Drain installation.....	5
3.5. Pipe installation.....	6
3.6. Electrical wiring.....	7
3.7. Remote controller setting.....	9
4. CASSETTE GRILLE INSTALLATION.....	9
4.1. Remove the intake grille.....	9
4.2. Installing the panel to indoor unit.....	9
4.3. Attach the intake grille.....	9
5. OPTIONAL INSTALLATION WORK.....	9
5.1. Optional kit installation.....	9
5.2. External input and output.....	10
5.3. Other optional parts.....	10
5.4. Optional parts cable binding.....	11
6. REMOTE CONTROL INSTALLATION.....	11
6.1. Group control.....	11
6.2. Multiple remote control.....	11
7. FUNCTION SETTING.....	11
7.1. Function details.....	11
8. CHECK LIST.....	14
9. TEST RUN.....	14
9.1. Check items.....	14
9.2. Operation method.....	14
10. FINISHING.....	14
10.1. Installing heat insulation.....	14
11. CUSTOMER GUIDANCE.....	14
12. ERROR CODES.....	14

NOTES: This manual describes how to install the air conditioner described above. Handling and installation shall only be done by professionals as outlined in this manual.

- Installation must be performed in accordance with the requirement of NEC (National Electrical Code) and CEC (Canadian Electrical Code) by authorized personnel only.
- All products are manufactured to metric units and tolerances. United States customary units are provided for reference only. In cases where exact dimensions and tolerances are required, always refer to metric units.

1. SAFETY PRECAUTIONS

1.1. IMPORTANT! Please read before starting

This air conditioning system meets strict safety and operating standards. As the installer or service person, it is an important part of your job to install or service the system so it operates safely and efficiently.

For safe installation and trouble-free operation, you must:

- Carefully read this instruction booklet before beginning.
- Follow each installation or repair step exactly as shown.
- Observe all local, state, and national electrical codes.
- Pay close attention to all danger, warning, and caution notices given in this manual.

WARNING: This symbol refers to a hazard or unsafe practice which can result in severe personal injury or death.

CAUTION: This symbol refers to a hazard or unsafe practice which can result in personal injury and the potential for product or property damage.

- Hazard alerting symbols



: Electrical



: Safety/alert

If Necessary, Get Help

These instructions are all you need for most installation sites and maintenance conditions. If you require help for a special problem, contact our sales/service outlet or your certified dealer for additional instructions.

In Case of Improper Installation

The manufacturer shall in no way be responsible for improper installation or maintenance service, including failure to follow the instructions in this document.

1.2. SPECIAL PRECAUTION

When Wiring

ELECTRICAL SHOCK CAN CAUSE SEVERE PERSONAL INJURY OR DEATH. ONLY A QUALIFIED, EXPERIENCED ELECTRICIAN SHOULD ATTEMPT TO WIRE THIS SYSTEM.

- Do not supply power to the unit until all wiring and tubing are completed or reconnected and checked.
- Highly dangerous electrical voltages are used in this system. Carefully refer to the wiring diagram and these instructions when wiring. Improper connections and inadequate grounding (earthing) can cause accidental injury or death.
- Ground (Earth) the unit following local electrical codes.
- Connect all wiring tightly. Loose wiring may cause overheating at connection points and a possible fire hazard.

When Transporting

Be careful when picking up and moving the indoor and outdoor units. Get a partner to help, and bend your knees when lifting to reduce strain on your back. Sharp edges or thin aluminum fins on the air conditioner can cut your fingers.

When Installing...

...In a Ceiling or Wall

Make sure the ceiling/wall is strong enough to hold the unit's weight. It may be necessary to construct a strong wood or metal frame to provide added support.

...In a Room

Properly insulate any tubing run inside a room to prevent "sweating" that can cause dripping and water damage to walls and floors.

...In an Area with High Winds

Securely anchor the outdoor unit down with bolts and a metal frame. Provide a suitable air baffle.

...In a Snowy Area (for Heat Pump-type Systems)

Install the outdoor unit on a raised platform that is higher than drifting snow.

When Connecting Refrigerant Tubing

- Keep all tubing runs as short as possible.
- Use the flare method for connecting tubing.
- Apply refrigerant lubricant to the matching surfaces of the flare and union tubes before connecting them, then tighten the nut with a torque wrench for a leak-free connection.
- Check carefully for leaks before opening the refrigerant valves.

When Servicing

- Turn the power OFF at the main circuit breaker panel before opening the unit to check or repair electrical parts and wiring.
- Keep your fingers and clothing away from any moving parts.
- Clean up the site after you finish, remembering to check that no metal scraps or bits of wiring have been left inside the unit being serviced.
- After installation, explain correct operation to the customer, using the operating manual.

⚠ WARNING

Never touch electrical components immediately after the power supply has been turned off. Electrical shock may occur. After turning off the power, always wait 10 minutes or more before touching electrical components.

- Be sure to read this manual thoroughly before installation.
- The warnings and precautions indicated in this Manual contain important information pertaining to your safety. Be sure to observe them.
- Hand this Manual, together with the operating manual, to the customer. Request the customer to keep them on hand for future use, such as for relocating or repairing the unit.

⚠ WARNING

- Installation of this product must be done by experienced service technicians or professional installers only in accordance with this manual. Installation by nonprofessional or improper installation of the product may cause serious accidents such as injury, water leakage, electric shock, or fire. If the product is installed in disregard of the instructions in this manual, it will void the manufacturer's warranty.
- Do not turn on the power until all work has been completed. Turning on the power before the work is completed can cause serious accidents such as electric shock or fire.
- If refrigerant leaks when you are working, ventilate the area. If the leaking refrigerant is exposed to a direct flame it may produce a toxic gas.
- Do not use this equipment with air or any other unspecified refrigerant in the refrigerant lines. Excess pressure can cause a rupture.
- Installation must be performed in accordance with regulations, codes, or standards for electrical wiring and equipment in each country, region, or the installation place.
- This appliance is not intended for use by persons (including children) with reduced physical, sensory or mental capabilities, or lack of experience and knowledge, unless they have been given supervision or instruction concerning use of the appliance by a person responsible for their safety. Children should be supervised to ensure that they do not play with the appliance.
- Cancer and Reproductive Harm - www.P65Warnings.ca.gov.

⚠ CAUTION

- Read carefully all safety information written in this manual before you install or use the air conditioner.
- Install the product by following local codes and regulations in force at the place of installation, and the instructions provided by the manufacturer.
- This product is part of a set constituting an air conditioner. The product must not be installed alone or be installed with non-authorized device by the manufacturer.
- Always use a separate power supply line protected by a circuit breaker operating on all wires with a distance between contact of 1/8 in (3 mm) for this product.
- To protect the persons, ground (earth) the product correctly, and use the power cable combined with an Earth Leakage Circuit Breaker (ELCB).
- This product is not explosion proof, and therefore should not be installed in explosive atmosphere.
- Do not touch the fins of the heat exchanger. Touching the heat exchanger fins could result in damage to the fins or personal injury such as skin rupture.
- This product contains no user-serviceable parts. Always consult experienced service technicians for repairing.
- When moving or relocating the air conditioner, consult experienced service technicians for disconnection and reinstallation of the product.
- Do not place any other electrical products or household belongings under the product. Condensation dripping from the product might get them wet, and may cause damage or malfunction to the property.

2. PRODUCT SPECIFICATION

2.1. Precaution for using R410A refrigerant

- The basic installation work procedures are the same as conventional refrigerant (R22) models. However, pay careful attention to the following points:
- Since the working pressure is 1.6 times higher than that of conventional refrigerant (R22) models, some of the piping and installation and service tools are special. (Refer to the following table.) Especially, when replacing a conventional refrigerant (R22) model with a new refrigerant R410A model, always replace the conventional piping and flare nuts with the R410A piping and flare nuts.
- Models that use refrigerant R410A have a different charging port thread diameter to prevent erroneous charging with conventional refrigerant (R22) and for safety. Therefore, check beforehand. [The charging port thread diameter for R410A is 1/2-20 UNF.]
- Be more careful that foreign matter (oil, water, etc.) does not enter the piping than with refrigerant (R22) models. Also, when storing the piping, securely seal the opening by pinching, taping, etc.
- When charging the refrigerant, take into account the slight change in the composition of the gas and liquid phases. And always charge from the liquid phase where refrigerant composition is stable.

2.2. Special tools for R410A

Tool name	Contents of change
Gauge manifold	Pressure is high and cannot be measured with a R22 gauge. To prevent erroneous mixing of other refrigerants, the diameter of each port has been changed. It is recommended to use gauge with seals -30 inHg to 768 psi (-0.1 to 5.3 MPa) for high pressure. -30 inHg to 551 psi (-0.1 to 3.8 MPa) for low pressure.
Charge hose	To increase pressure resistance, the hose material and base size were changed.
Vacuum pump	A conventional vacuum pump can be used by installing a vacuum pump adapter.
Gas leakage detector	Special gas leakage detector for HFC refrigerant R410A.

Copper pipes

It is necessary to use seamless copper pipes and it is desirable that the amount of residual oil is less than 0.004 oz/100 ft (40 mg/10 m). Do not use copper pipes having a collapsed, deformed or discolored portion (especially on the interior surface). Otherwise, the expansion valve or capillary tube may become blocked with contaminants. As an air conditioner using R410A incurs pressure higher than when using R22, it is necessary to choose adequate materials.

⚠ WARNING







- Do not use the existing (for R22) piping and flare nuts. If the existing materials are used, the pressure inside the refrigerant cycle will rise and cause failure, injury, etc. (Use the special R410A materials.)
- Use (refill or replace with) specified refrigerant (R410A) only. Use of unspecified refrigerant can cause product malfunction, burst, or injury.
- Do not mix any gas or impurities except specified refrigerant (R410A). Inflow of air or application of unspecified material makes the internal pressure of the refrigerant cycle too high, and may cause product malfunction, burst of piping, or injury.

2.3. Accessories

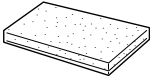

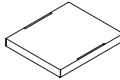
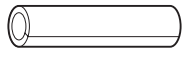

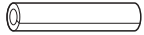

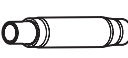
⚠ WARNING

For installation purposes, be sure to use the parts supplied by the manufacturer or other prescribed parts. The use of non-prescribed parts can cause serious accidents such as the unit to fall, water leakage, electric shock, or fire.

- Keep the Installation Manual in a safe place and do not discard any other accessories until the installation work has been completed.
- The following installation parts are furnished. Use them as required.

Name and Shape	Qty	Name and Shape	Qty
Operation manual 	1	Drain hose insulation 	1
Installation manual (This manual) 	1	Hose band 	1
Template (carton top) 	1	Coupler heat insulation (large) 	1
Special nut A (large flange) 	4	Coupler heat insulation (small) 	1
Special nut B (small flange) 	4	Cable tie (for electrical wiring) 	2
Drain hose (Ø 3/4 in [I.D.], Ø 1-1/16 in [O.D.]) 	1		

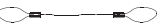
2.4. Cassette grille accessories

Name and Shape	Q'ty	Description
Connector cover 	1	For covering connector
Tapping screw (M5 × 12 mm) 	4	For mounting cassette grille
Tapping screw (M4 × 12 mm) 	1	For mounting connector cover
L angle 	2	For mounting the hook wire to the cassette grille
Hook wire 	2	For suspending the cassette grille
Screw [pitch small] (M4 × 10 mm) 	2	For mounting the hook wire (for metals)
Screw [pitch large] (M4 × 10 mm) 	4	For mounting the L angle and hook wire (for resins)

The following items are necessary to install this air conditioner. (The items are not included with the air conditioner and must be purchased separately.)

Additional materials	
Connection pipe assembly	Wall cap
Connection cable (4-conductor)	Saddle
Wall pipe	Drain hose
Decorative tape	Tapping screws
Vinyl tape	Putty

2.5. Pipe requirement

CAUTION

- Do not use existing pipes from another refrigeration system or refrigerant.
- Use pipes that have clean external and internal sides without any contamination which may cause trouble during use, such as sulfur, oxide, dust, cutting waste, oil, or water.
- It is necessary to use seamless copper pipes.
Material : Phosphor deoxidized seamless copper pipes
It is desirable that the amount of residual oil is less than 0.004 oz/100 ft (40 mg/10 m).
- Do not use copper pipes that have a collapsed, deformed, or discolored portion (especially on the interior surface). Otherwise, the expansion valve or capillary tube may become blocked with contaminants.
- Improper pipe selection will degrade performance. As an air conditioner using R410A incurs pressure higher than when using conventional (R22) refrigerant, it is necessary to choose adequate materials.

- Thicknesses of copper pipes used with R410A are as shown in the table.
- Never use copper pipes thinner than those indicated in the table even if they are available on the market.

Thicknesses of Annealed Copper Pipes (R410A)

Pipe outside diameter [in (mm)]	Thickness [in (mm)]
1/4 (6.35)	0.032 (0.80)
3/8 (9.52)	0.032 (0.80)
1/2 (12.70)	0.032 (0.80)
5/8 (15.88)	0.039 (1.00)
3/4 (19.05)	0.047 (1.20)

CAUTION

Refer to the installation manual for the outdoor unit for description of allowable pipe length and height difference.

Model	Diameter [in (mm)]	
	Liquid	Gas
09,12	1/4 (6.35)	3/8 (9.52)
18	1/4 (6.35)	1/2 (12.70)

- Use pipe with water-resistant heat insulation.

CAUTION

- Wrap heat insulation around both gas pipe and liquid pipe.
No heat-insulation work or incorrect heat-insulation work may cause water leaks.
- In a reverse cycle model, use heat insulation with heat resistance above 248 °F (120 °C).
- If expected humidity of the installation location of refrigerant pipes is higher than 70 %, wrap the heat insulation around the refrigerant pipes.
If the expected humidity is between 70 % and 80 %, use heat insulation that has a thickness of 9/16 in (15 mm) or more.
If the expected humidity is higher than 80 %, use heat insulation that has a thickness of 13/16 in (20 mm) or more.
- The use of thinner heat insulation than specified above, may cause a condensation on the surface of the insulation.
- Use heat insulation with thermal conductivity of 0.045 W/(m·K) or less (at 68 °F (20 °C)).

2.6. Electrical requirement

The indoor unit is powered from the outdoor unit. Do not power indoor unit from separate power source.

WARNING

Standard for electrical wiring and equipment differs in each country or region. Before you start electrical working, confirm related regulations, codes, or standards.

Cable	Conductor size (AWG)	Remarks
Connection cable	AWG 14	3 cable + Ground (Earth), 1 Ø 230 V

Cable Length: Limit voltage drop to less than 2%. Increase cable gauge if voltage drop is 2% or more.

2.7. Optional parts

Refer to each installation manual for the method of installing optional parts.

Parts name	Model No.	Application
Wireless remote controller	UTY-LNTU	For air conditioner operation
Wired remote controller	UTY-RNRUZ*	For air conditioner operation (2-wired type)
Simple remote controller	UTY-RSRY	For air conditioner operation (2-wired type)
	UTY-RHRY	
Fresh air intake kit	UTZ-VXAA	To take fresh air
Air outlet shutter plate	UTR-YDZB	Install the plate at outlet when carrying out 3-way direction operation
Insulation kit for High humidity	UTZ-KXGC	Install when the condition under the roof is over 80% in humidity and over 86°F (30°C) in temperature.
External input and output PCB / Box	UTY-XCSX	For external input and output
	UTZ-GXEA	
External connect kit	UTY-XWZXZG	For external output port
W-LAN interface	UTY-TFSXZ2	For wireless LAN interface
Modbus converter	-	Refer to Design & Technical manual.
KNX convertor	-	

3. INSTALLATION WORK

⚠ WARNING

Do not move the appliance by holding the indoor unit pipes.
(The stress applied to the pipe joints may cause the flammable gas to leak during operation.)

Especially, the installation place is very important for the split type air conditioner because it is very difficult to move from place to place after the first installation.

3.1. Selecting an installation location

⚠ WARNING

- Select installation locations that can properly support the weight of the indoor unit and which will not amplify sound or vibration. If the installation location is not strong enough, the indoor unit may fall and cause injuries.
- Install the units securely so that they do not topple or fall..

⚠ CAUTION

- Do not install the unit in the following areas:
 - Area with high salt content, such as at the seaside. It will deteriorate metal parts, causing the parts to fail or the unit to leak water.
 - Area filled with mineral oil or containing a large amount of splashed oil or steam, such as a kitchen. It will deteriorate plastic parts, causing the parts to fail or the unit to leak water.
 - Area where is close to heat sources.
 - Area that generates substances that adversely affect the equipment, such as sulfuric gas, chlorine gas, acid, or alkali. It will cause the copper pipes and brazed joints to corrode, which can cause refrigerant leakage.
 - Area that can cause combustible gas to leak, contains suspended carbon fibers or flammable dust, or volatile in flammables such as paint thinner or gasoline.
 - If gas leaks and settles around the unit, it can cause a fire.
 - Area where animals may urinate on the unit or ammonia may be generated.
- Do not use the unit for special purposes, such as storing food, raising animals, growing plants, or preserving precision devices or art objects. It can degrade the quality of the preserved or stored objects.
- Install the unit where drainage does not cause any trouble.
- Do not install where there is the danger of combustible gas leakage.
- Do not install the unit near a source of heat, steam, or flammable gas.
- Install the indoor unit, outdoor unit, power supply cable, transmission cable, and remote control cable at least 40 in (1 m) away from a television or radio receivers. The purpose of this is to prevent TV reception interference or radio noise. (Even if they are installed more than 40 in (1 m) apart, you could still receive noise under some signal conditions.)
- Install the unit where ambient temperature does not reach 140 °F (60 °C) or more. Take a measure such as ventilation for an environment in which heat is retained.
- If children under 10 years old may approach the unit, take preventive measures so that they cannot reach the unit.
- Install the indoor unit on the place where the height from the floor is more than 71 in (1.8 m).
- Use the "Insulation kit for high humidity" (option), when the condition under the roof is over 80% in humidity and over 86 °F (30 °C) in temperature. Otherwise, there is a risk of condensation on the ceiling.

Decide the mounting position together with the customer as follows:

- (1) Install the indoor unit in a location having sufficient strength to support the weight of the indoor unit.
- (2) The inlet and outlet ports should not be obstructed; the air should be able to blow all over the room.
- (3) Leave the space required to service the air conditioner.
- (4) Locate where the air can be distributed evenly throughout the room by the unit.
- (5) Install the unit where connection to the outdoor unit is easy.
- (6) Install the unit where the connection pipe can be easily installed.
- (7) Install the unit where the drain pipe can be easily installed.
- (8) Install the unit where noise and vibration is not amplified.
- (9) Take servicing, etc., into consideration and leave the spaces. Also install the unit where the filter can be removed.

3.2. Installation dimensions

- The ceiling rear height as shown in the figure.

[Unit: in (mm)]

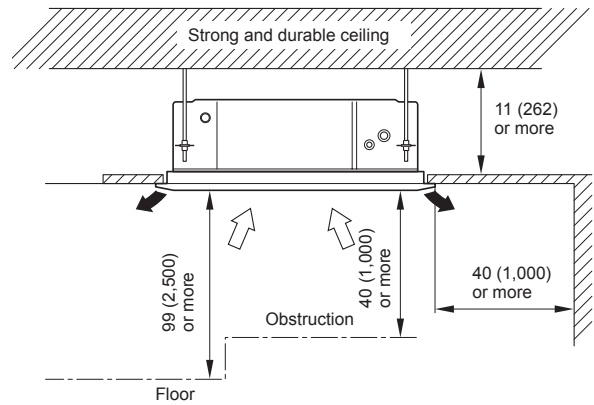

- This product can be installed at a height of up to 119 in (3,000 mm). However, 7000, 9000 Btu/h model can not be installed in high places. Perform the Function Setting on the remote control in accordance with the installed height. (Refer to "7. FUNCTION SETTING")

■ Discharge direction setting

- The discharge direction can be selected as shown below.

[Unit: in (mm)]

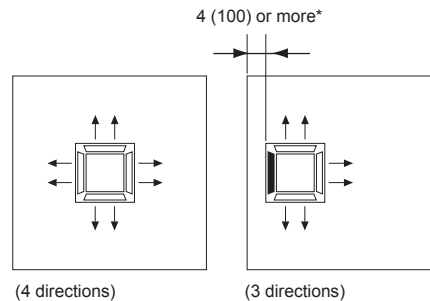

- For a 3-way outlet, make sure to perform the Function Setting on the remote control. Also, make sure to use the optional shutter plate to block the outlet.
- The ceiling height cannot be set in the 3-way outlet mode. Therefore, do not change the setting in the setting the ceiling height. (Refer to "7. FUNCTION SETTING")
- When the outlet is shut, be sure to install the optional Air outlet shutter plate kit. For the details of installation, refer to Installation Manual of kit.

3.3. Installing the unit

⚠ WARNING

- Install the air conditioner in a location which can withstand a load of at least 5 times the weight of the main unit and which will not amplify sound or vibration. If the installation location is not strong enough, the indoor unit may fall and cause injuries.
- If the job is done with the panel frame only, there is a risk that the unit will come loose. Take care.

3.3.1. Position the ceiling hole and hanging bolts

Ceiling openings and hanging bolt installation diagram.

⚠ WARNING

When fastening the hangers, make the bolt positions uniform.

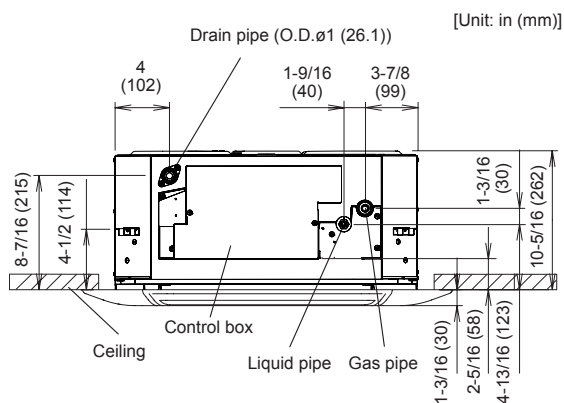
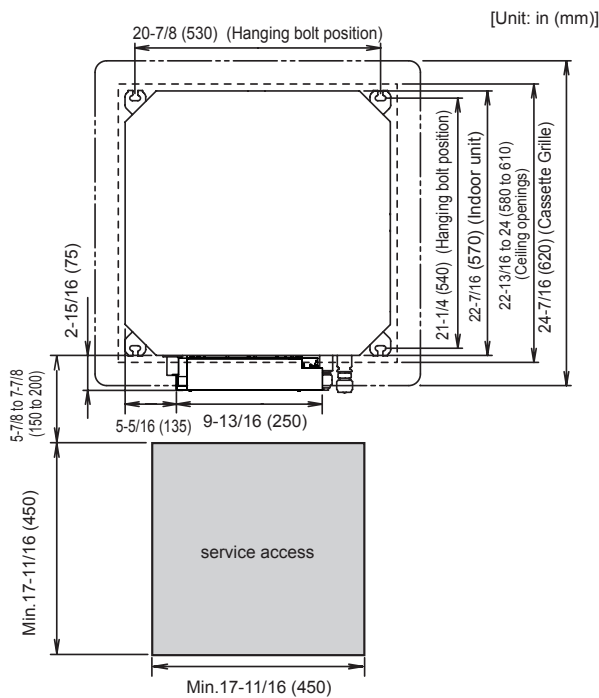

Be sure to keep sufficient space in the designated position for future maintenance.

3.3.2. Body installation

- (1) Install special nut A, then special nut B onto the hanging bolt.
- (2) Raise the body and mount its hooks onto the hanging bolt between the special nuts.
- (3) Turn special nut B to adjust the height of the body.

WARNING

- Perform final tightening by tightening the double nut firmly.
- Be sure to install the body horizontally and adjust the height below the body and the ceiling surface properly.

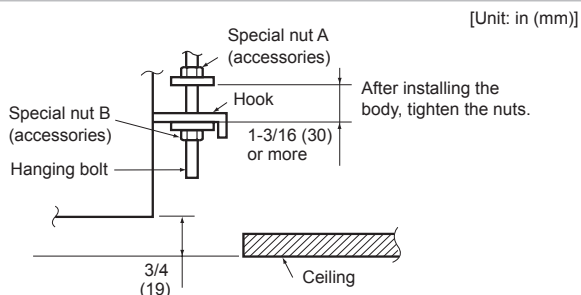

3.3.3. Leveling

Using a level, or vinyl hose filled with water, fine adjust so that the body is level. Inclined installation so as the drain pipe side is higher may cause a malfunction of the float switch, and may cause water leakage.

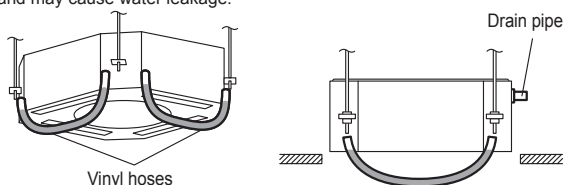

3.4. Drain installation

WARNING

- Do not insert the drain piping into the sewer where sulfurous gas occurs. (Heat exchange erosion may occur)
- Insulate the parts properly so that water will not drip from the connection parts.
- Check for proper drainage after installation by using the visible portion of transparent drain port and the drain piping final outlet on the body.

CAUTION

Do not apply adhesive agent on the drain port of the body. (Use the attached drain hose assembly to connect the drain piping)

3.4.1. Installing the drain pipe

When not lifting up drain pipe:

- Install the drain pipe with downward gradient (1/50 to 1/100) and so there are no rises or traps in the pipe.
- Use general hard polyvinyl chloride pipe (Ø 3/4 in [I.D.]; Ø 1-1/16 in [O.D.]) and connect it with adhesive (polyvinyl chloride) so that there is no leakage.
- When the pipe is long, install supporters.
- Do not perform air bleeding.
- Always heat insulate indoor section of drain pipe.
- If it is impossible to have sufficient gradient of pipe, perform drain lift-up.

Pipe size	
Drain pipe	Ø 3/4 in [I.D.]; Ø 1-1/16 in [O.D.]

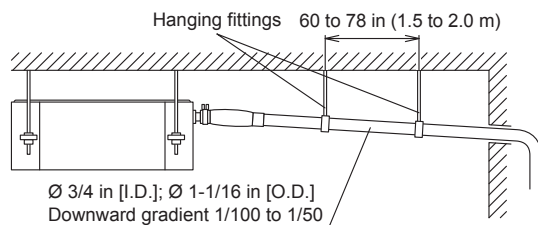

PROHIBITED:

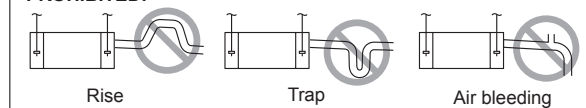

When lifting up drain pipe:

- Height of inclined pipe should be less than 27 in (700 mm) from the ceiling. A rise dimension over this range will cause leakage.
- Lift up the pipe vertically at the position of 11-13/16 in (300 mm) or less from the unit.

[Unit: in (mm)]

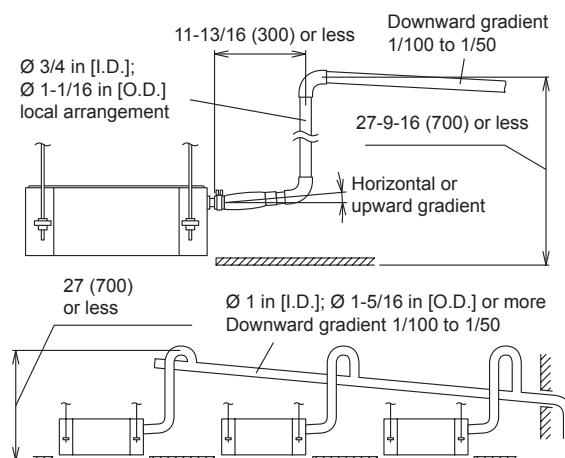

3.4.2. Installation procedure

- 1) Install the attached drain hose to the drain port of the body. Install the hose band from the top of the hose within the shown in the figure area.
- 2) Use vinyl adhesive agent to glue the drain piping (PVC pipe Ø 3/4 in [I.D.]; Ø 1-1/16 in [O.D.]) to the drain hose assembly. (Apply color adhesive agent evenly until the gauge line and seal)
- 3) Check the drainage. (Refer to separate diagram)
- 4) Install the heat insulation.

5) Use the attached heat insulation to insulate the drain port and hose band.

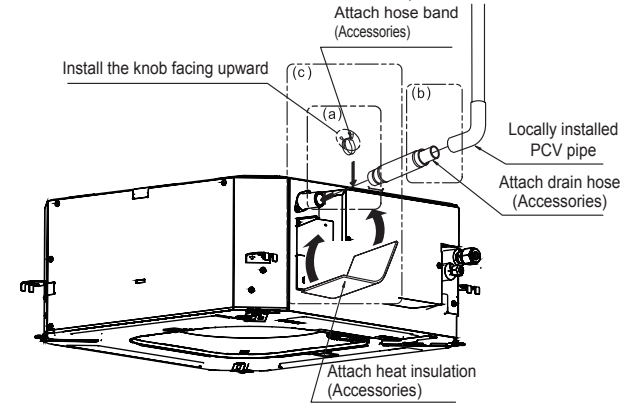

[Unit: in (mm)]

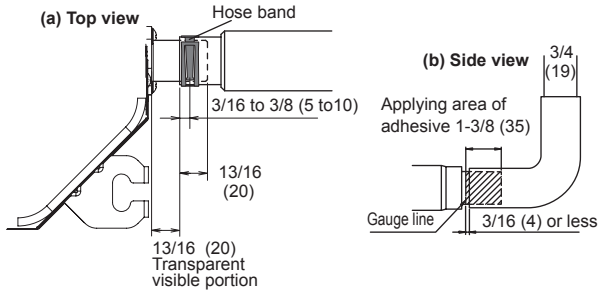

(c) Hose opening view

• Top view

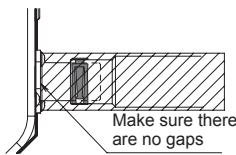

Wind the attached heat insulation around the hose band make sure the alignment is on top



NOTES:

Check for drainage

Pour about 1 liter of water from the position shown in the diagram or from the airflow outlet to the dew tray. Check for any abnormalities such as strange noises and whether the drain pump functions normally. The drain pump operates when operating in the cooling mode.

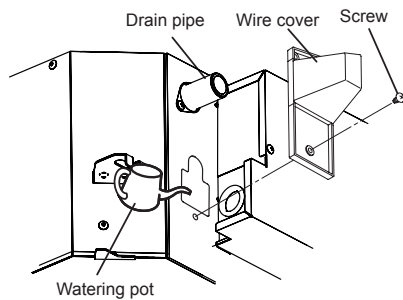

3.5. Pipe installation

CAUTION

- Tighten the flare nuts with a torque wrench using the specified tightening method. Otherwise, the flare nuts could break after a prolonged period, causing refrigerant to leak and generate hazardous gas if the refrigerant comes into contact with a flame.
- Be careful that foreign matter (oil, water, etc.) does not enter the piping with refrigerant R410A models. Also, when storing the piping, securely seal the openings by pinching, taping, etc.
- While brazing the pipes, be sure to purge with dry nitrogen gas.

3.5.1. Pipe connection

Flaring

Use special pipe cutter and flare tool designed for R410A pipework.

- (1) Cut the connection pipe to the necessary length with a pipe cutter.
- (2) Hold the pipe downward so that cuttings will not enter the pipe and remove any burrs.

- (3) Insert the flare nut (always use the flare nut attached to the indoor unit(s) and outdoor unit or branch box respectively) onto the pipe and perform the flare processing with a flare tool. Use the special R410A flare tool, or the conventional flare tool. Leakage of refrigerant may result if other flare nuts are used.
- (4) Protect the pipes by pinching them or with tape to prevent dust, dirt, or water from entering the pipes.

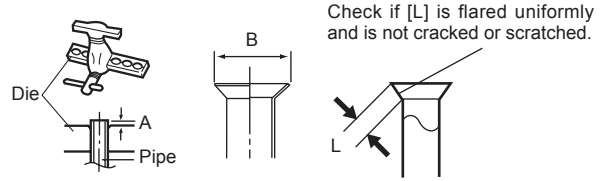

Pipe outside diameter [in (mm)]	Dimension A [in (mm)]	Dimension B [in (mm)]
	Flare tool for R410A, clutch type	
1/4 (6.35)	0 to 0.020 (0 to 0.5)	3/8 (9.1)
3/8 (9.52)		1/2 (13.2)
1/2 (12.70)		5/8 (16.6)
5/8 (15.88)		3/4 (19.7)
3/4 (19.05)		15/16 (24.0)

When using conventional flare tools to flare R410A pipes, the dimension A should be approximately 0.020 in (0.5 mm) more than indicated in the table (for flaring with R410A flare tools) to achieve the specified flaring. Use a thickness gauge to measure the dimension A.

Width across flats	Pipe outside diameter [in (mm)]	Width across flats of Flare nut [in (mm)]
		1/4 (6.35)
3/8 (9.52)		7/8 (22)
1/2 (12.70)		1 (26)
5/8 (15.88)		1-1/8 (29)
3/4 (19.05)		1-7/16 (36)

Bending pipes

CAUTION

- To prevent breaking of the pipe, avoid sharp bends.
- If the pipe is bent repeatedly at the same place, it will break.

- The pipes are shaped by your hands. Be careful not to collapse them.
- Bend R 2-3/4 in (70 mm) or more with a pipe bender.
- Do not bend the pipes in an angle more than 90°.
- When pipes are repeatedly bend or stretched, the material will harden, making it difficult to bend or stretch them anymore.
- Do not bend or stretch the pipes more than 3 times.
- When bending the pipe, do not bend it as is. The pipe will be collapsed. In this case, cut the insulating pipe with a sharp cutter as shown on the right, and bend it after exposing the pipe. After bending the pipe as you want, be sure to put the heat insulating pipe back on the pipe, and secure it with tape.

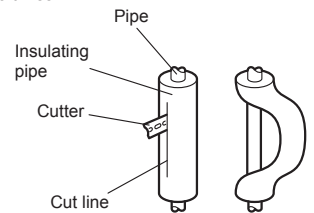

Flare connection

CAUTION

- Be sure to install the pipe against the port on the indoor unit correctly. If the centering is improper, the flare nut cannot be tightened smoothly. If the flare nut is forced to turn, the threads will be damaged.
- Do not remove the flare nut from the indoor unit pipe until immediately before connecting the connection pipe.
- Hold the torque wrench at its grip, keeping it in the right angle with the pipe, in order to tighten the flare nut correctly.
- Tighten the flare nuts with a torque wrench using the specified tightening method. Otherwise, the flare nuts could break after a prolonged period, causing refrigerant to leak and generate hazardous gas if the refrigerant comes into contact with a flame.
- Connect the piping so that the control box cover can easily be removed for servicing when necessary.
- In order to prevent water from leaking into the control box, make sure that the piping is well insulated.
- When flared joints are reused indoors, the flare part shall be re-fabricated.

- (1) Detach the caps and plugs from the pipes.
- (2) Center the pipe against the port on the indoor unit, and then turn the flare nut by hand.

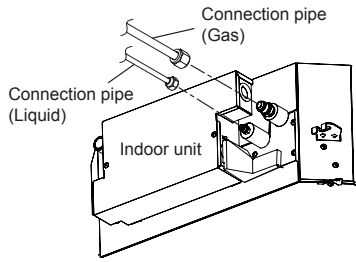

- (3) When the flare nut is tightened properly by your hand, hold the body side coupling with a wrench, then tighten with a torque wrench. (Refer to the following table for the flare nut tightening torques.)

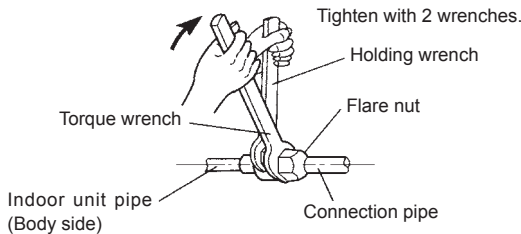

Flare nut [in (mm)]	Tightening torque [ft·lb (N·m)]
1/4 (6.35) dia.	12 to 13 (16 to 18)
3/8 (9.52) dia.	24 to 31 (32 to 42)
1/2 (12.70) dia.	36 to 45 (49 to 61)
5/8 (15.88) dia.	46 to 55 (63 to 75)
3/4 (19.05) dia.	66 to 81 (90 to 110)

Do not remove the cap from the connection pipe before connecting the pipe.

3.6. Electrical wiring

WARNING

- Electrical work must be performed in accordance with this Manual by a person certified under the national or regional regulations. Be sure to use a dedicated circuit for the unit. An insufficient power supply circuit or improperly performed electrical work can cause serious accidents such as electric shock or fire.
- Before starting work, check that power is not being supplied to the indoor unit and outdoor unit.
- For wiring, use the prescribed type of cables, connect them securely, making sure that there are no external forces of the cables applied to the terminal connections. Improperly connected or secured cables can cause serious accidents such as overheating the terminals, electric shock, or fire.
- Securely install the electrical box cover on the unit. An improperly installed electrical box cover can cause serious accidents such as electric shock or fire through exposure to dust or water.
- Install sleeves into any holes made in the walls for wiring. Otherwise, a short circuit could result.
- Use the included connection cables and power cables or ones specified by the manufacturer. Improper connections, insufficient insulation, or exceeding the allowable current can cause electric shock or fire.
- Do not modify the power cables, use extension cables, or use any branches in the wiring. Improper connections, insufficient insulation, or exceeding the allowable current can cause electric shock or fire.
- Match the terminal block numbers and connection cable colors with those of the outdoor unit or branch box. Erroneous wiring may cause burning of the electric parts.
- Securely connect the connection cables to the terminal board. In addition, secure the cables with wiring holders. Improper connections, either in the wiring or at the ends of the wiring, can cause a malfunction, electric shock, or fire.
- Always fasten the outside covering of the connection cable. (If the insulator is chafed, electric leakage may occur.)
- Install an earth leakage breaker. In addition, install the earth leakage breaker so that the entire AC main power supply is cut off at the same time. Otherwise, electric shock or fire could result.
- Always connect the ground (earth) cable. Improper grounding (earthing) work can cause electric shocks.
- Perform wiring work in accordance with standards so that the air conditioner can be operated safely and positively.
- Connect the connection cable firmly to the terminal board. Imperfect installation may cause a fire.
- Use ring terminals and tighten the terminal screws to the specified torques, otherwise, abnormal overheating may be produced and possibly cause heavy damage inside the unit.
- Install the remote controller cables so as not to be touched directly with your hand.
- Perform wiring work in accordance with standards so that the air conditioner can be operated safely and positively.
- Unit shall be grounded (earthed) in compliance with the applicable local and national codes.

CAUTION

- Be careful not to generate a spark as follows for using a flammable refrigerant.
 - Do not remove the fuse while the power is on.
 - Do not disconnect the wiring while the power is on.
 - It is recommended to position the outlet connection in a high position. Place the cords so that they do not get tangled.
- Ground (Earth) the unit. Do not connect the ground (earth) cable to a gas pipe, water pipe, lightning rod, or a telephone ground (earth) cable. Improper grounding (earthing) may cause electric shock.
- Install the remote controller cables so as not to be direct touched with your hand.
- Do not connect power supply cables to the transmission or remote controller terminals, as this will damage the product.
- Never bundle the power supply cable and transmission cable, remote controller cable together. Separate these cable by 2 in (50 mm) or more. Bundling these cables together will cause miss operation or breakdown.
- When handling PCB, static electricity charged in the body may cause malfunction of the PCB. Follow the cautions below:
 - Establish a ground (an earth) for the indoor and outdoor units and peripheral devices.
 - Cut power (breaker) off.
 - Touch metal part of the indoor and outdoor units for more than 10 seconds to discharge static electricity charged in the body.
 - Do not touch terminals of parts and patterns implemented on PCB.
- Be sure to refer to the below diagram for do correct field wiring. Wrong wiring causes malfunction of the unit.
- Check local electrical rules and also any specific wiring instructions or limitation.

3.6.1. Wiring system diagram

Standard pair

Connection cable

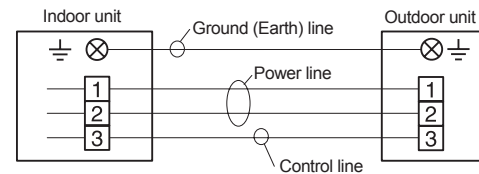

Wired remote controller cable

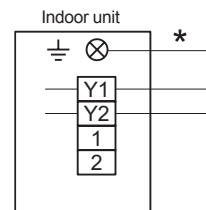

*Ground (Earth) the remote controller if it has an ground (earth) line.

Flexible multi-split type

Connection cable

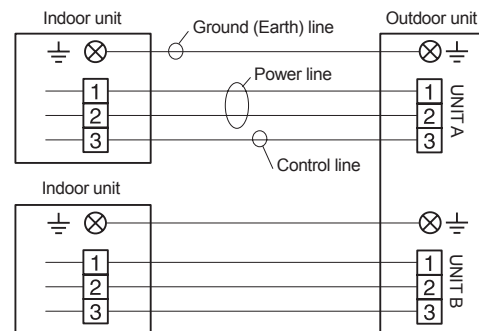

Wired remote controller cable

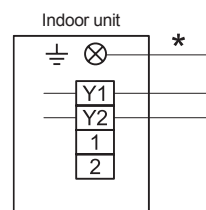

*Ground (Earth) the remote controller if it has a ground (earth) line.

3.6.2. Connection cable preparation

■ Connection cable

Keep the ground (earth) wire longer than the other wires.

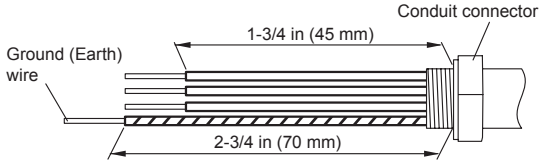

• Use a 4-core wire cable.

■ Remote controller cable

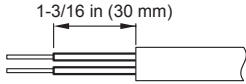

3.6.3. How to connect wiring to the terminals

■ Caution when wiring cable

To strip off the insulation of a lead wire, always use a special tool such as a wire stripper. If there is no special tool, carefully strip off the insulation by using a knife or other utensil.

- Use ring terminals with insulating sleeves as shown in the figure to connect to the terminal block.
- Securely clamp the ring terminals to the wires by using an appropriate tool so that the wires do not come loose.

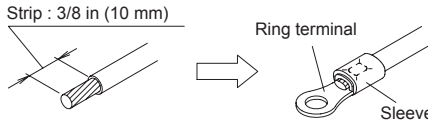

- Connect specified wires securely, and fasten them so that there is no stress applied on the terminals.
- Use a screwdriver with an appropriate bit size to tighten the terminal screws. Using of screwdriver with inappropriate bit size will damage the screw heads, and the screws will not be tightened properly.
- Do not overtighten the terminal screws. Otherwise, the screws may break.

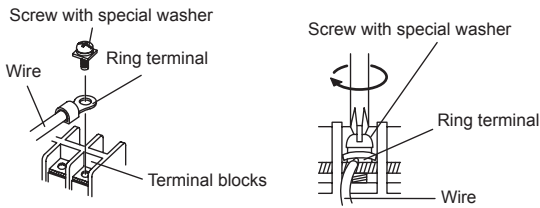

- Refer to the table for the terminal screw tightening torques.
- Do not fix 2 power supply cables with 1 screw.

Tightening torque [lbf-in (N·m)]

Tightening torque [lbf-in (N·m)]	
M4 screw	11 to 16 (1.2 to 1.8)

3.6.4. Connection wiring

⚠ CAUTION

- Be careful not to mistake the power supply cable and connection wires when installing.
- Install so that the wires for the remote controller will not come in contact with other connection wires.

- Remove the control box cover.
- Connect the connection cable.

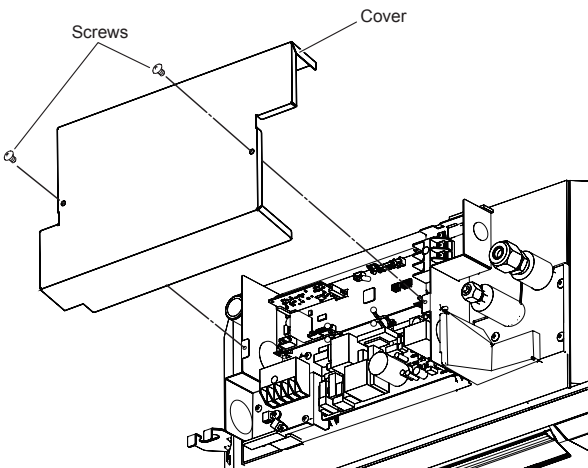

■ Connection cable

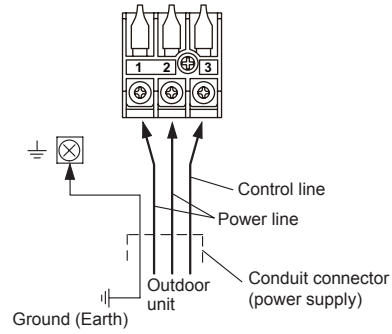

■ Remote controller cable

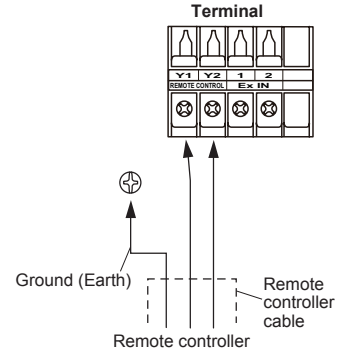

*Ground (Earth) the remote controller if it has a ground (earth) wire.

- After wiring is complete, secure the remote controller cable, conduit connector.

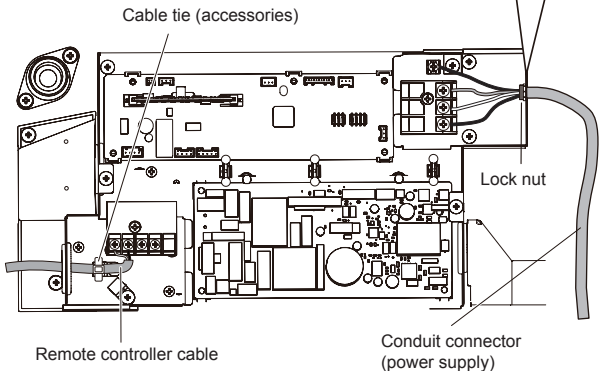
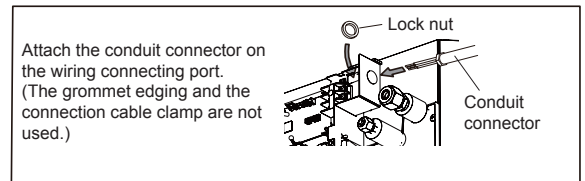

Do not bind the connection cable (power supply) and other cables together.

- Seal the cable outlet or other gaps with putty to prevent dew condensation or insect from entering the electric control box.
- Replace the control box cover.
- Fix the conduit with the supporters as shown below.

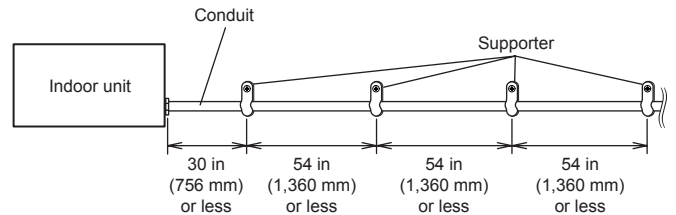

⚠ CAUTION

Do not bundle the remote controller cable, or wire the remote controller cable in parallel, with the indoor unit connection wire (to the outdoor unit) and the power supply cable. It may cause erroneous operation.

3.7. Remote controller setting

To install and set the remote controller, refer to the installation manual of the remote controller.

4. CASSETTE GRILLE INSTALLATION

- Installation according to the Installation instruction sheet Cassette grille.
- Be sure to confirm there is no gap between the panel and main unit after installing the Cassette grille.

4.1. Remove the intake grille

(1) Slide the 2 grille hooks.

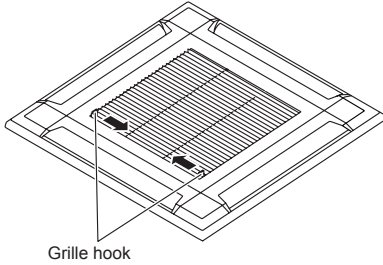

(2) Open the intake grille and remove.

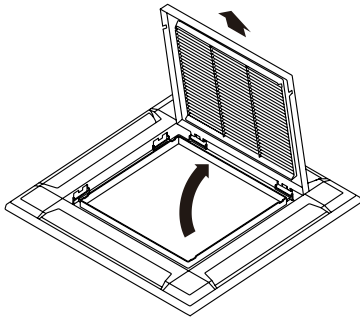

4.2. Installing the panel to indoor unit

(1) Install the cassette grille on the indoor unit.

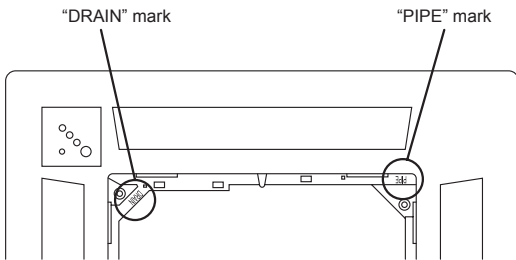

- Align the stamped marks on the cassette grille to the pipe and the drain of the indoor unit.

CAUTION

Use only the supplied screws to install the cassette grille.

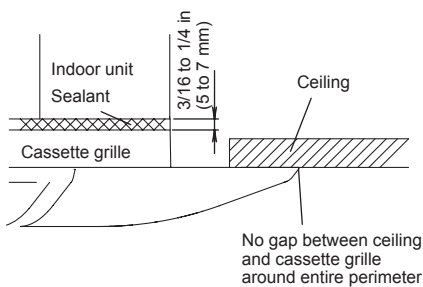

(2) Connect the connector.

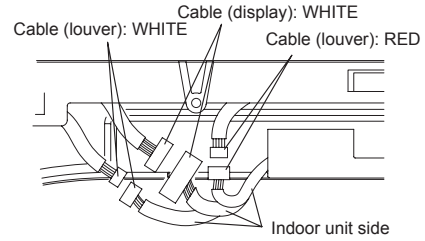

- Arrange the cables as illustrated below.

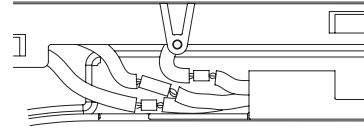

(3) Attach the connector cover.

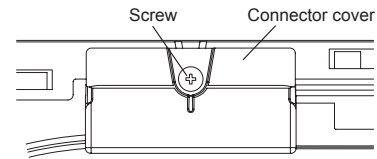

4.3. Attach the intake grille

The installation is the reverse of "REMOVING THE INTAKE GRILLE".

The intake grille can be rotated and installed 4 ways to suit the user's preference.

CAUTION

- The louver angle cannot be changed if the power is not on. (If moved by hand, it may be damaged.)
- The grille assembly is directionally relative to the air conditioner body.
- Install so that there is no gap between the grille assembly and the air conditioner body.
- The cassette grille equips with an accessory to prevent the grill completely open. Be sure to read the INSTALLATION SHEET included with the cassette grille before installation.

5. OPTIONAL INSTALLATION WORK

5.1. Optional kit installation

WARNING

Regulation of cable differs from each locality, refer in accordance with local rules.

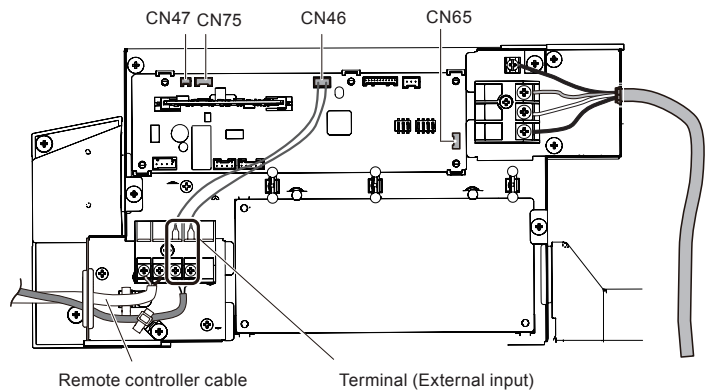

This air conditioner can be connected with the following optional kits.

For details on how to install optional parts, refer to the installation manual included in each item.

Connector No.	Option type
CN46	External input (PCB Terminal)
CN47	External output [*1] Fresh air intake kit
CN65	Other optional parts (External input and output PCB, Modbus converter, KNX converter, W-LAN interface *2 etc.) may be connectable. Refer to the technical data for details.
CN75	

*1: For external output terminal setting, refer to Function No.60 in "7. FUNCTION SETTING".

*2: Be sure to connect the W-LAN interface to CN75.

NOTES: Options connecting to CN47 cannot be used at the same time.

5.2. External input and output

5.2.1. External input

- Indoor unit functions such as Operation/Stop or Forced stop can be done by using indoor unit terminals.
- "Operation/Stop" mode or "Forced stop" mode can be selected with function setting of indoor unit.
- A twisted pair cable (22 AWG) should be used. Maximum length of cable is 492 ft (150 m).
- Use an external input and output cable with appropriate external dimension, depending on the number of cables to be installed.
- The wire connection should be separate from the power cable line.

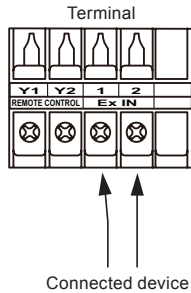

• Dry contact terminal

When a power supply is unnecessary at the input device you want to connect, use the Dry contact terminal.

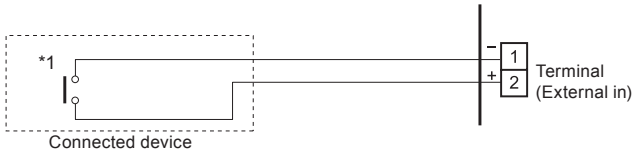

*1: The switch can be used on the following condition: DC 12 V to 24 V, 1 mA to 15 mA.

■ Operation behavior

• Input signal type



When function setting is "Operation/Stop" mode 1.

Input signal	Command
OFF → ON	Operation
ON → OFF	Stop

When function setting is "Forced stop" mode.

Input signal	Command
OFF → ON	Forced stop
ON → OFF	Normal

* When the forced stop is triggered, indoor unit stops and Operation/Stop operation by a remote controller is restricted.

When function setting is "Operation/Stop" mode 2.

Input signal	Command
OFF → ON	Operation
ON → OFF	Stop (R.C. disabled)

5.2.2. External output

- A twisted pair cable (22AWG) should be used. Maximum length of cable is 82 ft (25 m).
- Use an external input and output cable with appropriate external dimension, depending on the number of cables to be installed.
- Output voltage: Hi DC12V±2V, Lo 0V.
- Permissible current: 50mA

■ Output select

When interlocking with external device

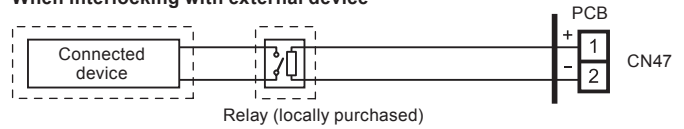

or
When displaying "Operation/Stop"

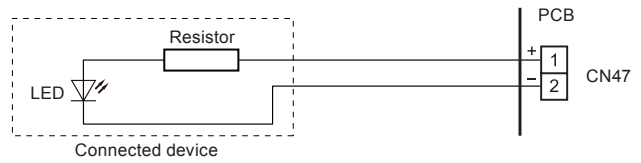

■ Operation behavior

Functions of the external output terminal can be switched.

(◀... Factory setting)

Function setting	Status	Output voltage
00	Stop	0 V
	Operation	DC 12 V
01 - 04	OFF	0 V
	Cooling thermostat ON	DC 12 V
05	OFF	0 V
	Heating operation ON	DC 12 V
06	Stop	0 V
	Operation	DC 12 V
07 - 08	OFF	0 V
	Cooling thermostat ON	DC 12 V
09	Normal	0 V
	Error	DC 12 V
10	Indoor unit fan stop	0 V
	Indoor unit fan operation	DC 12 V
11	External heater OFF	0 V
	External heater ON	DC 12 V

Refer to the Design & technical manual.

5.2.3. Connection methods

■ Wire modification

- Remove insulation from wire attached to wire kit connector.
- Remove insulation from locally purchased cable. Use crimp type insulated butt connector to join field cable and wire kit wire.
- Connect the wire with connecting wire with solder.

IMPORTANT: Be sure to insulate the connection between the wires.

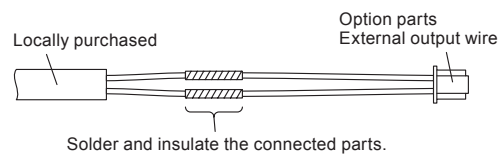

- Connecting wires to the terminals.
Use ring terminals with insulating sleeves to connect to the terminal block.
- Connection terminals and wiring arrangement (Refer to "5.3. Other optional parts")

5.3. Other optional parts

5.4.1. Connection method

- Connection terminals and wiring arrangement

In following figure, all the possible connections are done for description. In actual installation, connections will differ according to each installation requirements.

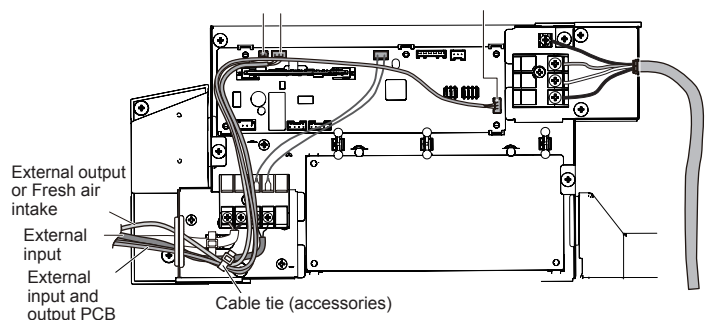

5.4. Optional parts cable binding

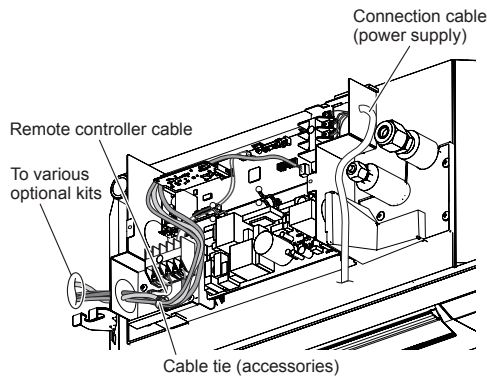

- Do not bind the connection cable (power supply) and other cables together.

CAUTION

To protect the cable insulation after opening a knockout hole, remove any burrs from the edge of the hole.

6. REMOTE CONTROL INSTALLATION

6.1. Group control

A number of indoor units can be operated at the same time using a single remote controller.
*When different types of indoor units (such as wall mounted type and cassette type, cassette type and duct type, or other combinations) are connected using group control system, some functions may no longer be available.

- Connect up to 16 indoor units in a system. (indoor unit to remote controller)

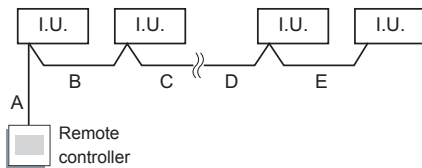

A, B, C, D, E : Remote controller cable.
A+B+C+D+E ≤ 1,640 ft (500 m).
Example of wiring method

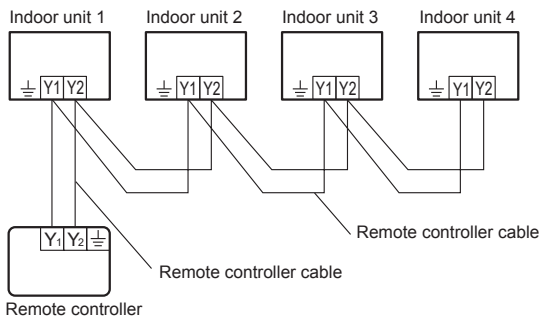

6.2. Multiple remote control

Up to 2 remote controllers can be used to operate the indoor units.

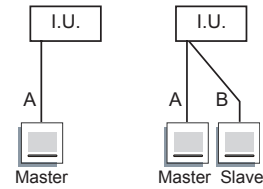

A, B : Remote controller cable. (Refer to "2.6. Electrical requirement".)
A ≤ 1,640 ft (500 m), A+B ≤ 1,640 ft (500 m)

- The timer and self-diagnosis functions cannot be used on the secondary units.

- Wiring method (indoor unit to remote controller)

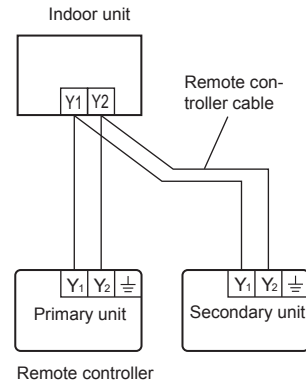

7. FUNCTION SETTING

Perform the Function setting according to the installation conditions using the remote controller.

CAUTION

- Confirm whether the wiring work for outdoor unit has been finished.
- Confirm that the cover for the electrical enclosure on the outdoor unit is in place.

- This procedure changes to the Function settings used to control the indoor unit according to the installation conditions. Incorrect settings can cause the indoor unit to malfunction.
- After the power is turned on, perform the Function setting according to the installation conditions using the remote controller.
- The settings may be selected between the following two: Function number or setting value.
- Settings will not be changed if invalid numbers or setting values are selected.

7.1. Function details

Filter sign

Select appropriate intervals for displaying the filter sign on the indoor unit according to the estimated amount of dust in the air of the room.

If the indication is not required, select "No indication" (03).

(♦... Factory setting)

Function number	Setting value	Setting description
11	00	Standard (2500 hours)
	01	Long interval (4400 hours)
	02	Short interval (1250 hours)
	03	No indication

Ceiling height

Select the appropriate ceiling height according to the place of installation.

(♦... Factory setting)

Function number	Setting value	Setting description
20	00	Standard (8 ft (2.7 m))
	01	High ceiling (9 ft (3.0 m))

In case of Cassette type models:

The ceiling height values are for the 4-way outlet.
Do not change this setting in the 3-way outlet mode.

■ Outlet directions

Select the appropriate number of outlet directions according to the installation conditions.
(◆... Factory setting)

Function number	Setting value	Setting description
22	00	4-way ◆
	01	3-way

■ Room temperature control for indoor unit sensor

Depending on the installed environment, correction of the room temperature sensor may be required.

Select the appropriate control setting according to the installed environment.

The temperature correction values show the difference from the "Standard setting" (00) (manufacturer's recommended value).

(◆... Factory setting)

Function number	Setting value	Setting description
30 (For cooling)	31 (For heating)	00 Standard setting ◆
		01 No correction 0 °F (0.0 °C)
		02 -1 °F (-0.5 °C)
		03 -2 °F (-1.0 °C)
		04 -3 °F (-1.5 °C)
		05 -4 °F (-2.0 °C)
		06 -5 °F (-2.5 °C)
		07 -6 °F (-3.0 °C)
		08 -7 °F (-3.5 °C)
		09 -8 °F (-4.0 °C)
		10 +1 °F (+0.5 °C)
		11 +2 °F (+1.0 °C)
		12 +3 °F (+1.5 °C)
		13 +4 °F (+2.0 °C)
		14 +5 °F (+2.5 °C)
		15 +6 °F (+3.0 °C)
		16 +7 °F (+3.5 °C)
17 +8 °F (+4.0 °C)		

More Cooling
Less Heating

Less Cooling
More Heating

■ Room temperature control for wired remote controller sensor

Depending on the installed environment, correction of the wire remote temperature sensor may be required.

Select the appropriate control setting according to the installed environment.

To change this setting, set Function 42 to "Both" (01).

Ensure that the Thermo Sensor icon is displayed on the remote controller screen.
(◆... Factory setting)

Function number	Setting value	Setting description
35 (For cooling)	36 (For heating)	00 No correction ◆
		01 No correction 0 °F (0.0 °C)
		02 -1 °F (-0.5 °C)
		03 -2 °F (-1.0 °C)
		04 -3 °F (-1.5 °C)
		05 -4 °F (-2.0 °C)
		06 -5 °F (-2.5 °C)
		07 -6 °F (-3.0 °C)
		08 -7 °F (-3.5 °C)
		09 -8 °F (-4.0 °C)
		10 +1 °F (+0.5 °C)
		11 +2 °F (+1.0 °C)
		12 +3 °F (+1.5 °C)
		13 +4 °F (+2.0 °C)
		14 +5 °F (+2.5 °C)
		15 +6 °F (+3.0 °C)
		16 +7 °F (+3.5 °C)
17 +8 °F (+4.0 °C)		

More Cooling
Less Heating

Less Cooling
More Heating

■ Auto restart

Enable or disable automatic restart after a power interruption.

(◆... Factory setting)

Function number	Setting value	Setting description
40	00	Enable ◆
	01	Disable

* Auto restart is an emergency function such as for power outage etc. Do not attempt to use this function in normal operation. Be sure to operate the unit by remote controller or external device.

■ Room temperature sensor switching

(Only for wired remote controller)

When using the wired remote controller temperature sensor, change the setting to "Both" (01).
(◆... Factory setting)

Function number	Setting value	Setting description
42	00	Indoor unit ◆
	01	Both

00: Sensor on the indoor unit is active.

01: Sensors on both indoor unit and wired remote controller are active.

* Remote controller sensor must be turned on by using the remote controller

■ Remote controller custom code

(Only for wireless remote controller)

The indoor unit custom code can be changed. Select the appropriate custom code.
(◆... Factory setting)

Function number	Setting value	Setting description
44	00	A ◆
	01	B
	02	C
	03	D

■ External input control

"Operation/Stop" mode or "Forced stop" mode can be selected.

(◆... Factory setting)

Function number	Setting value	Setting description
46	00	Operation/Stop mode 1 ◆
	01	(Setting prohibited)
	02	Forced stop mode
	03	Operation/Stop mode 2

■ Room temperature sensor switching (Aux.)

To use the temperature sensor on the wired remote controller only, change the setting to "Wired remote controller" (01). This function will only work if the function setting 42 is set at "Both" (01).
(◆... Factory setting)

Function number	Setting value	Setting description
48	00	Both ◆
	01	Wired remote controller

■ Indoor unit fan control for energy saving for cooling

Enables or disables the power-saving function by controlling the indoor unit fan rotation when the outdoor unit is stopped during cooling operation.

(◆... Factory setting)

Function number	Setting value	Setting description
49	00	Disable
	01	Enable ◆
	02	Remote controller

00: When the outdoor unit is stopped, the indoor unit fan operates continuously following the setting on the remote controller.

01: When the outdoor unit is stopped, the indoor unit fan operates intermittently at a very low speed.

02: Enable or disable this function by remote controller setting.

*When using a wired remote controller without Indoor unit fan control for energy saving for cooling function, or when connecting a single split converter, the setting cannot be made by using the remote controller. Set to (00) or (01).

To confirm if the remote controller has this function, refer to the operation manual of each remote controller.

■ Switching functions for external output terminal

Functions of the external output terminal can be switched.

(◆... Factory setting)

Function number	Setting value	Setting description
60	00	Operation status ◆
	01-04	Cooling thermostat status
	05	Heating operation status
	06	Operation status
	07-08	Cooling thermostat status
	09	Error status
	10	Fresh air control
	11	Auxiliary heater

Refer to the Design & technical manual.

■ Control switching of external heaters

Sets the control method for the external heater being used.

For details of the control method, see the Design & Technical Manual.

(◆... Factory setting)

Function number	Setting value	Setting description
61	00	Auxiliary heater control 1
	01	Auxiliary heater control 2
	02	Heat pump prohibition control
	03	Heater selection control using outdoor temperature 1
	04	Heater selection control using outdoor temperature 2
	05	Auxiliary heater control by outdoor temperature 3
	06	Auxiliary heat pump control
	07	Auxiliary heat pump control by outdoor temperature 1
	08	Auxiliary heat pump control by outdoor temperature 2
09	Auxiliary heat pump control by outdoor temperature 3	

■ Operating temperature switching of external heaters

• Sets the temperature conditions when the external heater is ON.

• For the temperature conditions, see "Temperature conditions when the external heater is ON". For a more detailed explanation, see the Design & Technical Manual.

(◆... Factory setting)

Function number	Setting value	Setting description
62	00	Setting 0
	01	Setting 1
	02	Setting 2
	03	Setting 3
	04	Setting 4
	05	Setting 5
	06	Setting 6
	07	Setting 7
	08	Setting 8
	09	Setting 9
	10	Setting 10
	11	Setting 11
	12	Setting 12
	13	Setting 13
	14	Setting 14
	15	Setting 15
	16	Setting 16
17	Setting 17	

Temperature conditions when the external heater is ON/OFF

Temperature (t) = Room temperature - set temperatur

		Set value of function: 61			
		00		01 to 09	
		ON	OFF	ON	OFF
Set value of function: 62	00	t < -5.4°F (-3°C)	t ≥ -1.8°F (-1°C)	t ≤ -0.9°F (-0.5°C)	t ≥ +0.9°F (+0.5°C)
	01	t < -3.6°F (-2°C)	t ≥ -1.8°F (-1°C)	t ≤ -1.8°F (-1°C)	t ≥ +0.9°F (+0.5°C)
	02	t < -3.6°F (-2°C)	t ≥ -1.8°F (-1°C)	t ≤ -3.6°F (-2°C)	t ≥ +0.9°F (+0.5°C)
	03	t < -5.4°F (-3°C)	t ≥ -1.8°F (-1°C)	t ≤ -5.4°F (-3°C)	t ≥ +0.9°F (+0.5°C)
	04	t < -7.2°F (-4°C)	t ≥ -1.8°F (-1°C)	t ≤ -7.2°F (-4°C)	t ≥ +0.9°F (+0.5°C)
	05	t < -9.0°F (-5°C)	t ≥ -1.8°F (-1°C)	t ≤ -9.0°F (-5°C)	t ≥ +0.9°F (+0.5°C)
	06	t < -5.4°F (-3°C)	t ≥ -0.9°F (-0.5°C)	t ≤ -0.9°F (-0.5°C)	t ≥ 0°F (0°C)
	07	t < -3.6°F (-2°C)	t ≥ -0.9°F (-0.5°C)	t ≤ -1.8°F (-1°C)	t ≥ 0°F (0°C)
	08	t < -3.6°F (-2°C)	t ≥ -0.9°F (-0.5°C)	t ≤ -3.6°F (-2°C)	t ≥ 0°F (0°C)
	09	t < -5.4°F (-3°C)	t ≥ -0.9°F (-0.5°C)	t ≤ -5.4°F (-3°C)	t ≥ 0°F (0°C)
	10	t < -7.2°F (-4°C)	t ≥ -0.9°F (-0.5°C)	t ≤ -7.2°F (-4°C)	t ≥ 0°F (0°C)
	11	t < -9.0°F (-5°C)	t ≥ -0.9°F (-0.5°C)	t ≤ -9.0°F (-5°C)	t ≥ 0°F (0°C)
	12	t < -5.4°F (-3°C)	t ≥ 0°F (0°C)	t ≤ -0.9°F (-0.5°C)	t ≥ -0.9°F (-0.5°C)
	13	t < -3.6°F (-2°C)	t ≥ 0°F (0°C)	t ≤ -1.8°F (-1°C)	t ≥ -0.9°F (-0.5°C)
	14	t < -3.6°F (-2°C)	t ≥ 0°F (0°C)	t ≤ -3.6°F (-2°C)	t ≥ -0.9°F (-0.5°C)
	15	t < -5.4°F (-3°C)	t ≥ 0°F (0°C)	t ≤ -5.4°F (-3°C)	t ≥ -0.9°F (-0.5°C)
	16	t < -7.2°F (-4°C)	t ≥ 0°F (0°C)	t ≤ -7.2°F (-4°C)	t ≥ -0.9°F (-0.5°C)
17	t < -9.0°F (-5°C)	t ≥ 0°F (0°C)	t ≤ -9.0°F (-5°C)	t ≥ -0.9°F (-0.5°C)	

■ Outdoor temperature zone boundary temperature A

Setting required if changing of the outdoor temperature setting for heat pump prohibition zone is required when auxiliary heater control by outdoor temperature 1 and 2 are performed on the indoor unit.

For details of the control method, see the Design & Technical Manual.

(◆... Factory setting)

Function number	Setting value	Setting description
66	00	-4.0 °F (-20 °C)
	01	-0.4 °F (-18 °C)
	02	3.2 °F (-16 °C)
	03	6.8 °F (-14 °C)
	04	10.4 °F (-12 °C)
	05	14.0 °F (-10 °C)
	06	17.6 °F (-8 °C)
	07	21.2 °F (-6 °C)
08	24.8 °F (-4 °C)	

■ Outdoor temperature zone boundary temperature B

Setting required if changing of the outdoor temperature setting for heat pump only zone is required when auxiliary heater control by outdoor temperature 1 is performed on the indoor unit.

For details of the control method, see the Design & Technical Manual.

(◆... Factory setting)

Function number	Setting value	Setting description
67	00	42.8 °F (6 °C)
	01	14.0 °F (-10 °C)
	02	17.6 °F (-8 °C)
	03	21.2 °F (-6 °C)
	04	24.8 °F (-4 °C)
	05	28.4 °F (-2 °C)
	06	32.0 °F (0 °C)
	07	35.6 °F (2 °C)
	08	39.2 °F (4 °C)
	09	42.8 °F (6 °C)
	10	46.4 °F (8 °C)
	11	50.0 °F (10 °C)
	12	53.6 °F (12 °C)
	13	57.2 °F (14 °C)
	14	60.8 °F (16 °C)
15	64.4 °F (18 °C)	

■ Standby time for auxiliary equipment operation

Sets the standby time until the auxiliary equipment operation starts during primary equipment operation.

(◆... Factory setting)

Function number	Setting value	Setting description
71	00	Disable
	01	1 minutes
	02	2 minutes
	⋮	⋮
	98	98 minutes
	99	99 minutes

■ Heat pump backup setting

Enables or disables the heat pump backup instruction from the outdoor unit. This function will be usable provided that the corresponding outdoor unit is connected.

(◆... Factory setting)

Function number	Setting value	Setting description
72	00	Disable
	01	Enable

■ Emergency heat for external output terminal

Enables or disables emergency heat input.

To use this function, select "External heater output" after entering "Function Number 60". For more information, please refer to the Design & technical manual.

(◆... Factory setting)

Function number	Setting value	Setting description
73	00	Disable
	01	Enable

■ External heater use in defrosting

Enables or disables the external heater use in defrosting.
When using function, inappropriate heater selection may cause cold air in defrosting.
(◆... Factory setting)

Function number	Setting value	Setting description
75	00	Disable
	01	Enable

■ Setting record

Record any changes to the settings in the following table.

No.	Setting description	Setting value
11	Filter sign	
20	Ceiling height	
22	Outlet directions	
30	Room temperature control for indoor unit sensor	Cooling
31		Heating
35	Room temperature control for wired remote controller sensor	Cooling
36		Heating
40	Auto restart	
42	Room temperature sensor switching	
44	Remote controller custom code	
46	External input control	
48	Room temperature sensor switching (Aux.)	
49	Indoor unit fan control for energy saving for cooling	
60	Switching functions for external output terminal	
61	Control switching of external heaters	
62	Operating temperature switching of external heaters	
66	Outdoor temperature zone boundary temperature A	
67	Outdoor temperature zone boundary temperature B	
71	Standby time for auxiliary equipment operation	
72	Heat pump backup setting	
73	Emergency heat for external output terminal	
75	External heater use in defrosting	

After completing the Function Setting, be sure to turn off the power and turn it on again.

8. CHECK LIST

Pay special attention to the check items below when installing the indoor unit(s). After installation is complete, be sure to check the following check items again.

CHECK ITEMS	If not performed correctly	CHECK BOX
Has the indoor unit been installed correctly?	Vibration, noise, indoor unit may drop	
Has there been a check for gas leaks (refrigerant pipes)?	No cooling, No heating	
Has heat insulation work been completed?	Water leakage	
Does water drain easily from the indoor units?	Water leakage	
Are the wires and pipes all connected completely?	No operation, heat or burn damage	
Is the connection cable the specified thickness?	No operation, heat or burn damage	
Are the inlets and outlets free of any obstacles?	No cooling, No heating	
After installation is completed, has the proper operation and handling been explained to the user?		

9. TEST RUN

9.1. Check items

- Is operation of each button on the remote controller normal?
- Does each lamp light normally?
- Is the drain normal?
- Do not have an abnormal noise and vibration during operation?

Do not operate the air conditioner in test run for a long time.

9.2. Operation method

Depending on your installation, choose from the following:

■ By the wireless remote controller (with [TEST RUN] button)

- (1) To start test run, press [START/STOP] and [TEST RUN] on the remote controller.
- (2) To end test run, press [START/STOP] on the remote controller.

■ By the indoor unit or IR receiver unit

- (1) To start test run, press [MANUAL AUTO] of the unit for more than 10 seconds (forced cooling).
- (2) To end test run, press [MANUAL AUTO] for more than 3 seconds or press [START/STOP] on the remote controller.
 - The Operation indicator lamp and Timer indicator lamp will simultaneously flash during the test run mode.

■ By the wired remote controller

- (1) For the operation method, refer to the installation manual and the operation manual of the wired remote controller.

Heating test run will begin in a few minutes when HEAT is selected by the remote controller [reverse cycle model only].

10. FINISHING

10.1. Installing heat insulation

⚠ CAUTION

- After checking for gas leaks (refer to the Installation Manual of the outdoor unit), perform this section.
- Install heat insulation around both the large (gas) and small (liquid) pipes. Failure to do so may cause water leaks.
- Must fit tightly against body without any gap.

After checking for gas leaks, insulate by wrapping insulation around the 2 parts (gas and liquid) of the indoor unit coupling, using the Coupler Heat Insulation.
After installing the Coupler Heat Insulation, wrap both ends with vinyl tape so that there is no gap.

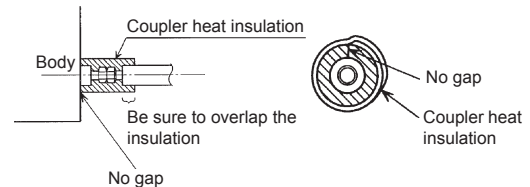

11. CUSTOMER GUIDANCE

Explain the following to the customer in accordance with the operation manual:

- (1) Starting and stopping method, operation switching, temperature adjustment, timer, air flow switching, and other remote controller operations.
- (2) Cleaning and maintenance of the product, and other items such as air filters and air louvers if applicable.
- (3) Give the operating and installation manuals to the customer.
- (4) If the indoor unit custom code is changed, and the installation includes a wireless remote controller, inform the customer the changed code. (On some wireless remote controllers, the custom code may return to A when batteries are replaced.)

12. ERROR CODES

If you use a wireless remote controller, the lamp on the photo detector unit will output error codes by way of blinking patterns. If you use a wired remote controller, error codes will appear on the remote control display. Refer to the lamp blinking patterns and error codes in the table. An error display is displayed only during operation.

The error code contains errors irrelevant to this product as well.

Error display			Error code	Description
OPERATION lamp (green)	TIMER lamp (orange)	ECONOMY lamp (green)		
●(1)	●(1)	◇	11	Serial communication error
●(1)	●(2)	◇	12	• Wired remote controller communication error • Server room control communication error
●(1)	●(5)	◇	15	Check run unfinished Automatic airflow adjustment error
●(1)	●(6)	◇	16	Peripheral unit transmission PCB connection error
●(1)	●(8)	◇	18	External communication error
●(2)	●(1)	◇	21	Unit number or Refrigerant circuit address setting error [simultaneous multi-split type]
●(2)	●(2)	◇	22	Indoor unit capacity error
●(2)	●(3)	◇	23	Combination error

Error display			Error code	Description
OPERATION lamp (green)	TIMER lamp (orange)	ECONOMY lamp (green)		
●(2)	●(4)	◇	24	• Connection unit number error (indoor secondary unit) [simultaneous multi-split type] • Connection unit number error (indoor unit or branch unit) [flexible multi-split type]
●(2)	●(6)	◇	26	Indoor unit address setting error
●(2)	●(7)	◇	27	Primary unit, secondary unit setup error [simultaneous multi-split type]
●(2)	●(9)	◇	29	Connection unit number error in wired remote controller system
●(3)	●(1)	◇	31	Power supply interruption error
●(3)	●(2)	◇	32	Indoor unit PCB model information error
●(3)	●(3)	◇	33	Indoor unit motor electricity consumption detection error
●(3)	●(5)	◇	35	Manual auto switch error
●(3)	●(9)	◇	39	Indoor unit power supply error for fan motor
●(3)	●(10)	◇	3A	Indoor unit communication circuit (wired remote controller) error
●(4)	●(1)	◇	41	Room temp. sensor error
●(4)	●(2)	◇	42	Indoor unit heat ex. middle temp. sensor error
●(4)	●(4)	◇	44	Human sensor error
●(5)	●(1)	◇	51	Indoor unit fan motor error
●(5)	●(3)	◇	53	Drain pump error
●(5)	●(4)	◇	54	Electric air cleaner reverse VDD error
●(5)	●(5)	◇	55	Filter set error
●(5)	●(7)	◇	57	Damper error
●(5)	●(8)	◇	58	Intake grille error
●(5)	●(9)	◇	59	Indoor unit fan motor 2 error (Left side fan)
●(5)	●(10)	◇	5A	Indoor unit fan motor 3 error (Right side fan)
●(5)	●(15)	◇	5U	Indoor unit error
●(6)	●(1)	◇	61	Outdoor unit reverse/missing phase and wiring error
●(6)	●(2)	◇	62	Outdoor unit main PCB model information error or communication error
●(6)	●(3)	◇	63	Inverter error
●(6)	●(4)	◇	64	Active filter error, PFC circuit error
●(6)	●(5)	◇	65	Trip terminal L error
●(6)	●(8)	◇	68	Outdoor unit rush current limiting resistor temp. rise error
●(6)	●(10)	◇	6A	Display PCB microcomputers communication error
●(7)	●(1)	◇	71	Discharge temp. sensor error
●(7)	●(2)	◇	72	Compressor temp. sensor error
●(7)	●(3)	◇	73	Outdoor unit Heat Ex. liquid temp. sensor error
●(7)	●(4)	◇	74	Outdoor temp. sensor error

Error display			Error code	Description
OPERATION lamp (green)	TIMER lamp (orange)	ECONOMY lamp (green)		
●(7)	●(5)	◇	75	Suction Gas temp. sensor error
●(7)	●(6)	◇	76	• 2-way valve temp. sensor error • 3-way valve temp. sensor error
●(7)	●(7)	◇	77	Heat sink temp. sensor error
●(8)	●(2)	◇	82	• Sub-cool Heat Ex. gas inlet temp. sensor error • Sub-cool Heat Ex. gas outlet temp. sensor error
●(8)	●(3)	◇	83	Liquid pipe temp. sensor error
●(8)	●(4)	◇	84	Current sensor error
●(8)	●(6)	◇	86	• Discharge pressure sensor error • Suction pressure sensor error • High pressure switch error
●(9)	●(4)	◇	94	Trip detection
●(9)	●(5)	◇	95	Compressor rotor position detection error (permanent stop)
●(9)	●(7)	◇	97	Outdoor unit fan motor 1 error
●(9)	●(8)	◇	98	Outdoor unit fan motor 2 error
●(9)	●(9)	◇	99	4-way valve error
●(9)	●(10)	◇	9A	Coil (expansion valve) error
●(10)	●(1)	◇	A1	Discharge temp. error
●(10)	●(3)	◇	A3	Compressor temp. error
●(10)	●(4)	◇	A4	High pressure error
●(10)	●(5)	◇	A5	Low pressure error
●(13)	●(2)	◇	J2	Branch boxes error [flexible multi-split type]

Display mode ● : 0.5s ON / 0.5s OFF
◇ : 0.1s ON / 0.1s OFF
() : Number of flashing

■ Error display on the indoor unit

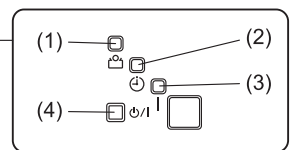
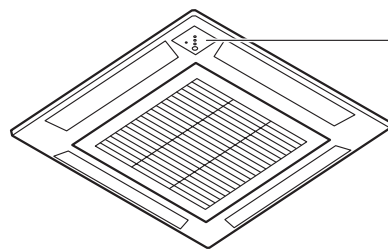

- (1) ECONOMY indicator lamp (Green)
- (2) Timer indicator lamp (Orange)
- (3) Operation indicator lamp (Green)
- (4) Manual auto button