

For authorized service personnel only.

- Branch box which is specified in this manual is the equipment to support the indoor unit of multi-connection type.
- All products are manufactured to metric units and tolerances. United States customary units are provided for reference only. In cases where exact dimensions and tolerances are required, always refer to metric units.

Contents

1. SAFETY PRECAUTIONS.....	1
1.1. IMPORTANT! Read before starting	1
1.2. Special precautions	1
2. PRODUCT SPECIFICATION.....	2
2.1. Precautions for using R410A refrigerant.....	2
2.2. Installation tools	2
2.3. For authorized service personnel only.....	2
2.4. Accessories	2
2.5. Pipe requirement	3
2.6. Electrical requirement.....	3
2.7. Optional parts	3
3. INSTALLATION WORK	3
3.1. Selecting an installation location	3
3.2. Removing and replacing parts.....	3
3.3. Pipe installation	4
3.4. Electrical wiring.....	6
3.5. Remote controller installation	7
4. OPTIONAL INSTALLATION WORK	8
4.1. Optional kit installation.....	8
4.2. Group control.....	9
5. FUNCTION SETTING.....	10
5.1. Function details	10
5.2. Temperature correction.....	11
6. TEST RUN.....	12
7. FINISHING	12
8. CUSTOMER GUIDANCE	12
9. ERROR CODES	13

1. SAFETY PRECAUTIONS

1.1. IMPORTANT! Read before starting

This air conditioning system meets strict safety and operating standards. As the installer or service person, it is an important part of your job to install or service the system so it operates safely and efficiently.

For safe installation and trouble-free operation, you must:

- Carefully read this instruction booklet before beginning.
- Follow each installation or repair step exactly as shown.
- Observe all local, state, and national electrical codes.
- Pay close attention to all warning and caution notices given in this manual.



WARNING This symbol refers to a hazard or unsafe practice which can result in severe personal injury or death.



CAUTION This symbol refers to a hazard or unsafe practice which can result in personal injury and the potential for product or property damage.

- Hazard alerting symbols



Electrical



Safety/alert

If Necessary, Get Help

These instructions are all you need for most installation sites and maintenance conditions. If you require help for a special problem, contact our sales/service outlet or your certified dealer for additional instructions.

In Case of Improper Installation

The manufacturer shall in no way be responsible for improper installation or maintenance service, including failure to follow the instructions in this document.

1.2. Special precautions

When Wiring

ELECTRICAL SHOCK CAN CAUSE SEVERE PERSONAL INJURY OR DEATH. ONLY A QUALIFIED, EXPERIENCED ELECTRICIAN SHOULD ATTEMPT TO WIRE THIS SYSTEM.

- Do not supply power to the unit until all wiring and tubing are completed or reconnected and checked.
- Highly dangerous electrical voltages are used in this system. Carefully refer to the wiring diagram and these instructions when wiring. Improper connections and inadequate grounding (earthing) can cause accidental injury or death.
- Ground (earth) the unit following local electrical codes.
- Connect all wiring tightly. Loose wiring may cause overheating at connection points and a possible fire hazard.

When Transporting

Be careful when picking up and moving the indoor and outdoor units. Get a partner to help, and bend your knees when lifting to reduce strain on your back. Sharp edges or thin aluminum fins on the air conditioner can cut your fingers.

When Installing...

...In a Ceiling or Wall

Make sure the ceiling/wall is strong enough to hold the unit's weight. It may be necessary to construct a strong wood or metal frame to provide added support.

...In a Room

Properly insulate any tubing run inside a room to prevent "sweating" that can cause dripping and water damage to walls and floors.

...In an Area with High Winds

Securely anchor the outdoor unit down with bolts and a metal frame. Provide a suitable air baffle.

...In a Snowy Area (for Heat Pump-type Systems)

Install the outdoor unit on a raised platform that is higher than drifting snow.

When Connecting Refrigerant Tubing

- Keep all tubing runs as short as possible.
- Use the flare method for connecting tubing.
- Apply refrigerant lubricant to the matching surfaces of the flare and union tubes before connecting them, then tighten the nut with a torque wrench for a leak-free connection.
- Check carefully for leaks before opening the refrigerant valves.

When Servicing

- Turn the power OFF at the main circuit breaker panel before opening the unit to check or repair electrical parts and wiring.
- Keep your fingers and clothing away from any moving parts.
- Clean up the site after you finish, remembering to check that no metal scraps or bits of wiring have been left inside the unit being serviced.
- After installation, explain correct operation to the customer, using the operation manual.

WARNING

- Never touch electrical components immediately after the power supply has been turned off. Electric shock may occur. After turning off the power, always wait 10 minutes before touching electrical components.
- If refrigerant leaks while work is being carried out, ventilate the area. If the refrigerant comes in contact with a flame, it produces a toxic gas.
- Keep any required ventilation openings clear of obstruction.
- If the power cable or the connection cable is damaged, it must be replaced by the manufacturer, its service agent or similar qualified persons in order to avoid a safety hazard.
- Cancer and Reproductive Harm - www.P65Warnings.ca.gov.

⚠ CAUTION

- Do not attempt to install the air conditioner or a part of the air conditioner by yourself.
- This unit must be installed by qualified personnel with a capacity certificate for handling refrigerant fluids. Refer to regulation and laws in use on installation place.
- This unit is part of a set constituting an air conditioner. It must not be installed alone or with a device non-authorized by the manufacturer.
- Always use a separate power supply line protected by a circuit breaker operating on all wires with a distance between contact of 1/8 in. (3 mm) for this unit.
- The unit must be correctly earthed (grounded) and the supply line must be equipped with a differential breaker in order to protect the persons.
- The units are not explosion proof and therefore should not be installed in explosive atmosphere.
- When moving, consult authorized service personnel for disconnection and installation of the unit.
- Do not place any other electrical products or household belongings under indoor unit or outdoor unit.
Dripping condensation from the unit might get them wet, and may cause damage or malfunction of your property.

⚠ CAUTION

This manual describes how to install the indoor unit only. To install the outdoor unit or branch box, (if any), refer to the installation manual included in each product.

2. PRODUCT SPECIFICATION

2.1. Precautions for using R410A refrigerant

The basic installation work procedures are the same as conventional refrigerant (R22) models.

However, pay careful attention to the following points:

- Since the working pressure is 1.6 times higher than that of conventional refrigerant (R22) models, some of the piping and installation and service tools are special. (Refer to the following table.)
Especially, when replacing a conventional refrigerant (R22) model with a new refrigerant R410A model, always replace the conventional piping and flare nuts with the R410A piping and flare nuts.
- Models that use refrigerant R410A have a different charging port thread diameter to prevent erroneous charging with conventional refrigerant (R22) and for safety. Therefore, check beforehand. [The charging port thread diameter for R410A is 1/2-20 UNF.]
- Be more careful that foreign matter (oil, water, etc.) does not enter the piping than with refrigerant (R22) models. Also, when storing the piping, securely seal the opening by pinching, taping, etc.
- When charging the refrigerant, take into account the slight change in the composition of the gas and liquid phases. And always charge from the liquid phase where refrigerant composition is stable.

2.2. Installation tools

Tool name	Contents of change
Gauge manifold	Pressure is high and cannot be measured with a R22 gauge. To prevent erroneous mixing of other refrigerants, the diameter of each port has been changed. It is recommended the gauge with seals -30 inHg to 768 psi (-0.1 to 5.3 MPa) for high pressure. -30 inHg to 551 psi (-0.1 to 3.8 MPa) for low pressure.
Charge hose	To increase pressure resistance, the hose material and base size were changed.
Vacuum pump	A conventional vacuum pump can be used by installing a vacuum pump adapter.
Gas leakage detector	Special gas leakage detector for HFC refrigerant R410A.

■ Copper pipes

It is necessary to use seamless copper pipes and it is desirable that the amount of residual oil is less than 0.004 oz/100 ft. (40 mg/10 m). Do not use copper pipes having a collapsed, deformed or discolored portion (especially on the interior surface). Otherwise, the expansion valve or capillary tube may become blocked with contaminants.

As an air conditioner using R410A incurs pressure higher than when using R22, it is necessary to choose adequate materials.

⚠ WARNING

- Do not use the existing (for R22) piping and flare nuts.
If the existing materials are used, the pressure inside the refrigerant cycle will rise and cause failure, injury, etc. (Use the special R410A materials.)
- Use (refill or replace with) specified refrigerant (R410A) only. Use of unspecified refrigerant can cause product malfunction, burst, or injury.
- Do not mix any gas or impurities except specified refrigerant (R410A). Inflow of air or application of unspecified material makes the internal pressure of the refrigerant cycle too high, and may cause product malfunction, burst of piping, or injury.
- For installation purposes, be sure to use the parts supplied by the manufacturer or other prescribed parts. The use of non-prescribed parts can cause serious accidents such as the unit falling, water leakage, electric shock, or fire.
- Do not turn on the power until all work has been completed.

2.3. For authorized service personnel only.

⚠ WARNING

- For appropriate working of the air conditioner, install it as outlined in this manual.
- To connect the indoor unit and outdoor unit or branch box, use air conditioner piping and cables available through your local distributor. This manual describes proper connections using such installation set.
- Do not reconnect the power until all work has been completed.











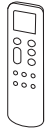

⚠ CAUTION

This installation manual describes how to install the indoor unit only. To install the outdoor unit or branch box, refer to the installation manual included with the outdoor unit or branch box.

- Be careful not to scratch the air conditioner when handling it.
- After installation, explain correct operation to the customer, using the operation manual.

2.4. Accessories

The following installation accessories are supplied. Use them as required.

Name and Shape	Q'ty	Name and Shape	Q'ty
Operation manual 	1	Tapping screw (large) 	5
Installation manual (This manual) 	1	Tapping screw (small) 	2
Remote controller 	1	Battery 	2
Remote controller holder 	1	Wall hook bracket 	1
Cloth tape 	1	Ion deodorization filter (light blue) 	1
Filter holder 	2	Apple-catechin filter (White) 	1
Seal A 	1	It is used when the diameter of gas pipe is Ø1/2 in (12.70 mm) or more. It is necessary when using AS15.	

The following items are necessary to install this air conditioner. (The items are not included with the air conditioner and must be purchased separately.)

Additional materials	
Connection pipe assembly	Saddle
Connection cable (4-conductor)	Drain hose
Wall pipe	Tapping screw
Decorative tape	Sealant
Vinyl tape	Putty
Wall cap	

2.5. Pipe requirement

CAUTION

Refer to the installation manual for the outdoor unit for description of allowable pipe length and height difference.

Model	Liquid pipe size <thickness>	Gas pipe size <thickness>
07, 09, 12	Ø 1/4 in (Ø 6.35 mm) <1/16 in (0.80 mm)>	Ø 3/8 in (Ø 9.52 mm) <1/16 in (0.80 mm)>
15	Ø 1/4 in (Ø 6.35 mm) <1/16 in (0.80 mm)>	Ø 1/2 in (Ø 12.70 mm) <1/16 in (0.80 mm)>

CAUTION

Install heat insulation around both the gas and liquid pipes. Failure to do so may cause water leaks.
Use heat insulation with heat resistance above 248 °F (120 °C). Reverse cycle model only.

In addition, if the humidity level at the installation location of the refrigerant piping is expected to exceed 70%, install heat insulation around the refrigerant piping. If the expected humidity level is 70-80%, use heat insulation that is 3/4 in. (15 mm) or thicker and if the expected humidity exceeds 80%, use heat insulation that is 13/16 in. (20 mm) or thicker.

If heat insulation is used that is not as thick as specified, condensation may form on the surface of the insulation. In addition, use heat insulation with heat conductivity of 0.045 W/(m·K) or less (at [68 °F (20 °C)]).

2.6. Electrical requirement

The indoor unit is powered from the outdoor unit or branch box. Do not power indoor unit from separate power source.

WARNING

Standard for electrical wiring and equipment differs in each country or region. Before you start electrical working, confirm related regulations, codes, or standards.

■ Cable specification

Cable	Cable size	Remarks
Connection cable	14AWG	3 cable+Ground (earth), 1φ 208/230 V

Max. Cable Length: Limit voltage drop to less than 2%. Increase cable gauge if voltage drop is 2% or more.

2.7. Optional parts

Refer to each installation manual for the method of installing optional parts.

Parts name	Model No.	Application
Wired remote controller (*1) (*2)	UTY-RNR*Z*	For air conditioner operation (2-wired type)
Simple remote controller (*1)	UTY-RSR* UTY-RHR*	
External input and output PCB	UTY-XCSXZ2	For control input/output port
External connect kit	UTY-XWZXZ5 UTY-XWZX	
Communication kit	UTY-TWRXZ2	For the installation of 2-wired remote controller
WLAN adapter	UTY-TFSXF1	For wireless LAN control

* Optional parts are subject to change without notice.

*1: Optional Communication kit (UTY-TWRXZ2) is necessary for installation.

*2: The wired remote controller (UTY-RNR*Z*) and the wireless controller cannot be used simultaneously.

3. INSTALLATION WORK

3.1. Selecting an installation location

Decide the mounting position with the customer as follows:

- Install the indoor unit level on a strong wall which is not subject to vibration.
- The inlet and outlet ports should not be obstructed: the air should be able to blow all over the room.
- Install the unit a dedicated electrical branch circuit.
- Do not install the unit where it will be exposed to direct sunlight.
- Install the unit where connection to the outdoor unit or branch box is easy.
- Install the unit where the drain pipe can be easily installed.
- Take servicing, etc. into consideration and leave the spaces shown in "3.1.1. Installation dimensions". Also install the unit where the filter can be removed.

Correct initial installation location is important because it is difficult to move unit after it is installed.

WARNING

Install the air conditioner in a location which can withstand a load of at least 3 times the weight of the main unit and which will not amplify sound or vibration. If the installation location is not strong enough, the indoor unit may fall and cause injuries.

Withstandable weight (Unit weight x 3*)

66 lbs (30 kg)

*In accordance with UL standards.

CAUTION

- Do not install the unit in the following areas:
 - Area with high salt content, such as at the seaside. It will deteriorate metal parts, causing the parts to fail or the unit to leak water.
 - Area filled with mineral oil or containing a large amount of splashed oil or steam, such as a kitchen. It will deteriorate plastic parts, causing the parts to fail or the unit to leak water.
 - Area that generates substances that adversely affect the equipment, such as sulfuric gas, chlorine gas, acid, or alkali. It will cause the copper pipes and brazed joints to corrode, which can cause refrigerant leakage.
 - Area that can cause combustible gas to leak, contains suspended carbon fibers or flammable dust, or volatile inflammables such as paint thinner or gasoline. If gas leaks and settles around the unit, it can cause a fire.
 - Area where animals may urinate on the unit or ammonia may be generated.
- Do not use the unit for special purposes, such as storing food, raising animals, growing plants, or preserving precision devices or art objects. It can degrade the quality of the preserved or stored objects.
- Do not install where there is the warning of combustible gas leakage.
- Do not install the unit near a source of heat, steam, or flammable gas.
- Install the unit where drainage does not cause any trouble.
- Install the indoor unit, outdoor unit, branch box, power supply cable, connection cable, and remote controller cable at least 40 in. (1m) away from a television or radio receivers. The purpose of this is to prevent TV reception interference or radio noise. (Even if they are installed more than 40 in. (1m) apart, you could still receive noise under some signal conditions.)
- If children under 10 years old may approach the unit, take preventive measures so that they cannot reach the unit.
- Install the indoor unit on the wall where the height from the floors more than 71 in. (1.8 m).

3.1.1. Installation dimensions

Keep the distance between the wall hook bracket or indoor unit to the surrounding walls as indicated in the following figure.

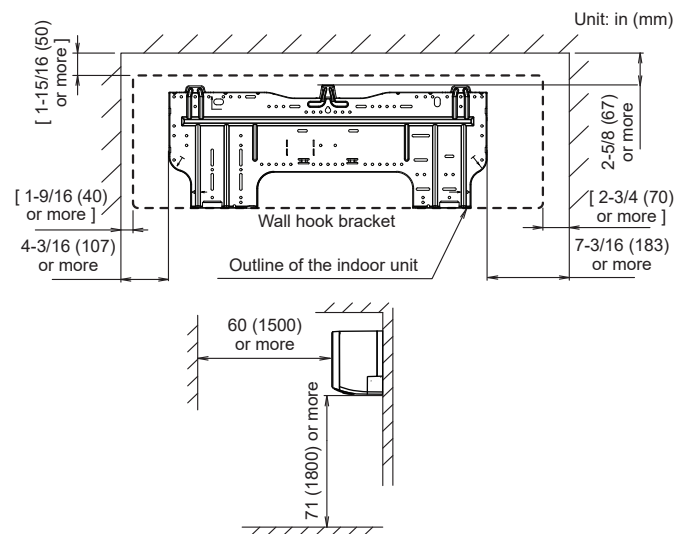

3.2. Removing and replacing parts

3.2.1. Intake grille removal and installation

■ Intake grille removal

- Hold the intake grille with both hands at the side, then pull to the front until it becomes hooked.
- Keeping the intake grille in a horizontal position, pull the mounting shaft on the left and right to release.

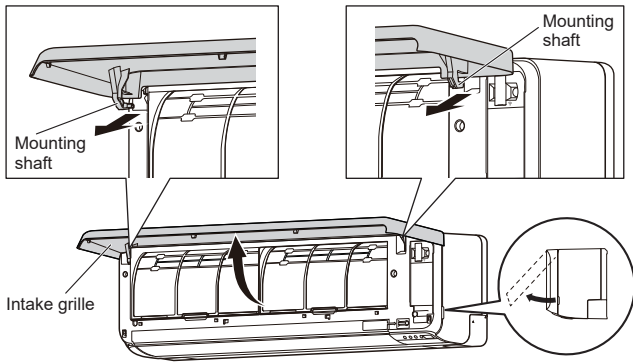

■ Intake grille installation

- (1) Attach the left and right mounting shaft in the direction of the arrow to the panel top bearing while supporting the intake grille horizontally. Press this until it clicks so that each shaft snaps into place.

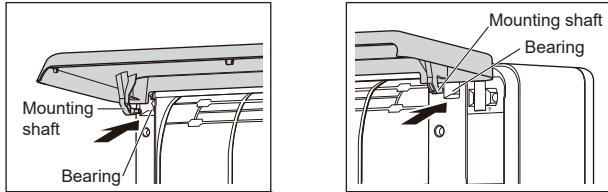

- (2) Press and close the intake grille.

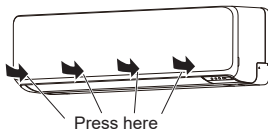

3.2.2. Front panel / control cover removal and installation

* In this description, the intake grille and wire cover already has been removed.
When the wire cover A is removed, the wire cover B can be removed.

■ Front panel / control cover / under cover (L/R/C) removal

- (1) Remove the under cover L/R.* (Press down on the markings on the side, then slide down.)
*: If needed, remove the piping groove and make a necessary adjustment.
- (2) Remove under cover C.
 - Remove the cap screws (2 places).
 - Remove the screws (2 places).
 - Pull down the center of the under cover C and remove it. **
- (3) Remove the screw covers (2 places) on the bottom of the front panel, and then remove the screws (4 places).
- (4) Push down on the markings (2 places) on top of the front panel to release the hooks (3 places), then pull the front panel towards you.
- (5) Pinch the tab on the control cover to release the hook, then open.

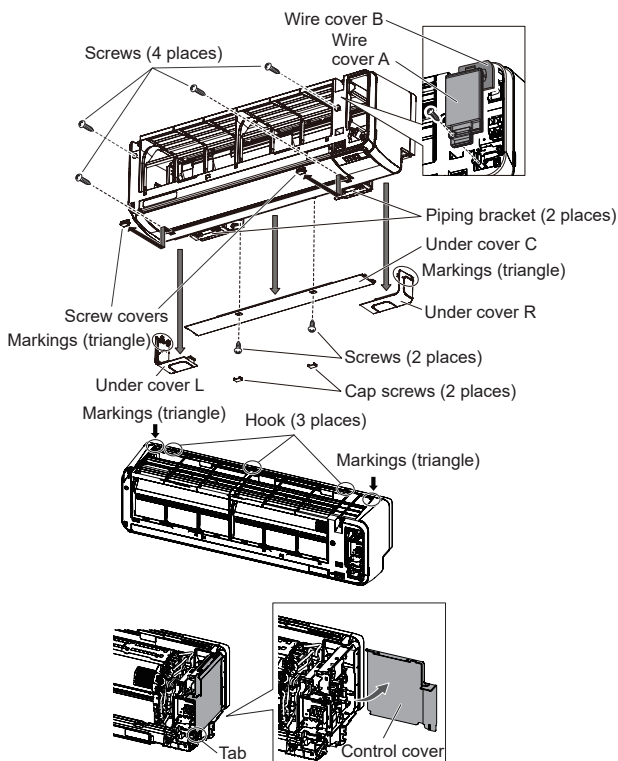

■ Front panel / control cover / under cover (L/R/C) installation

Install the previous figure in reverse order.
* Be sure to attach the screws (4 places), screw cover(2 places) for front panel and screws (2 places), cap screw (2 places) for under cover C.

⚠ CAUTION

Take caution when removing or installing the front panel. If the front panel falls, there is a risk of injury.

3.2.3. Uninstalling the indoor unit

Remove the indoor unit from the wall hook bracket as follows.

- (1) Put your fingers in the outer opening of the piping holder (A) in the figure. While pushing down the piping holder (A), remove the hook from the wall hook bracket (2 places).
- (2) Pull the indoor unit towards you.

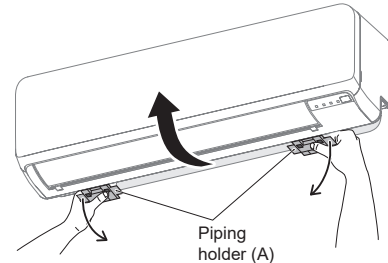

3.3. Pipe installation

3.3.1. Indoor unit piping direction

The piping can be connected in the 6 directions indicated in the following.
When the piping is connected to direction (B), (C), (D) or (E), cut along the piping groove on the side of the under cover with a hacksaw.

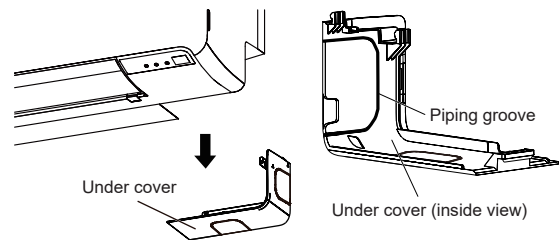
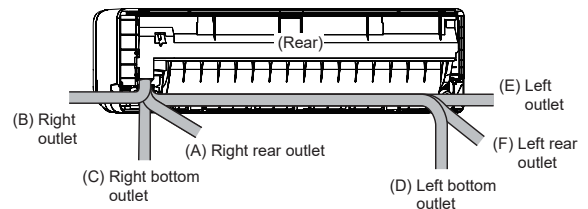

3.3.2. Cutting the hole in the wall for connecting the pipes

- (1) Cut a 2-9/16 in (65 mm) diameter hole in the wall at the position shown in the following.
- (2) Cut the hole so that the outside end is lower (3/16 to 3/8 in [5 to 10 mm]) than the inside end.
- (3) Always align the center of the wall hole. If misaligned, water leakage will occur.
- (4) Cut the wall pipe to match the wall thickness, stick it into the wall cap, fasten the cap with vinyl tape, and stick the pipe through the hole.
- (5) For the left piping and the right piping, cut the hole a little lower so that drain water will flow freely.

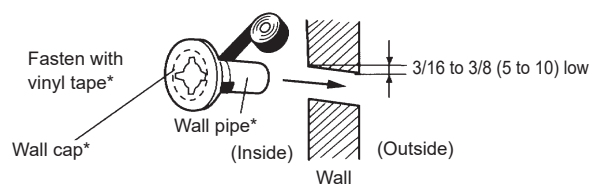
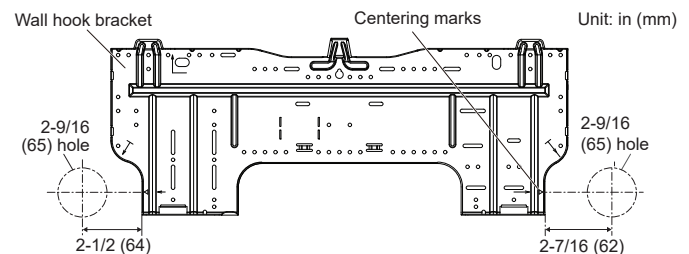

*Locally purchased

⚠ WARNING

Always use the wall pipe. If the wall pipe is not used, the cable that is connected between the indoor unit and the outdoor unit may touch metal, and cause an electric discharge.

3.3.3. Installing the wall hook bracket

- Install the wall hook bracket so that it is correctly positioned horizontally and vertically. If the wall hook bracket is tilted, water will drip to the floor.
- Install the wall hook bracket so that it is strong enough to support the weight of the unit.
 - Fasten the wall hook bracket to the wall with 5 or more screws through the holes near the outer edge of the bracket.
 - Check that there is no rattle at the wall hook bracket.

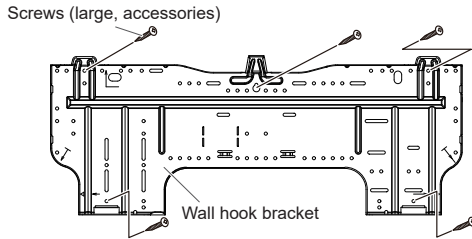

⚠ CAUTION

Install the wall hook bracket both horizontally and vertically aligned. Misaligned installation may cause water leakage.

3.3.4. Forming the drain hose and pipe

⚠ CAUTION

- Insert drain hose and drain cap securely. Drain should slope down to avoid water leakage.
- When inserting the drain hose, no other material than water should be applied. Application of other material than water will cause deterioration of the hose, and may cause water leakage.
- After you remove a drain hose, be sure to attach the drain cap.
- When you secure the piping and drain hose with tape, arrange the drain hose so that it is at the bottom of the piping.
- For drain hose piping in low temperature environment, you need to apply freeze protection to prevent a frozen drain hose. After cooling operation is performed in low temperature environment (when outdoor temperature under 32 °F [0 °C]), water in the drain hose could be frozen. Frozen drain water will block the water flow in the hose, and may cause water leakage at the indoor unit.

■ Right rear piping, Right piping, Right bottom piping

- Install the indoor unit piping in the direction of the wall hole and bind the drain hose and pipe together with vinyl tape.
- Install the piping so that the drain hose is at the bottom.
- Wrap the pipes of the indoor unit that are visible from the outside with decorative tape.

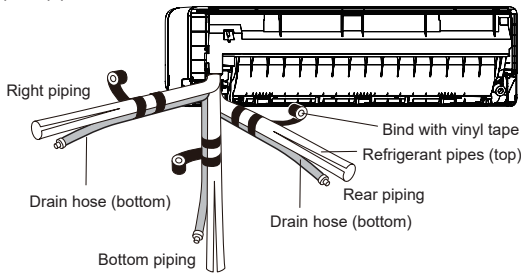

■ For Left rear piping (Drain hose), Left piping (Drain hose), Left bottom piping (Drain hose)

Interchange the drain cap and the drain hose.

■ Installing the drain cap

Use a hexagonal wrench 3/16 in (4 mm) at opposite side to insert the drain cap, till the drain cap contacts the tip of the drain cock.

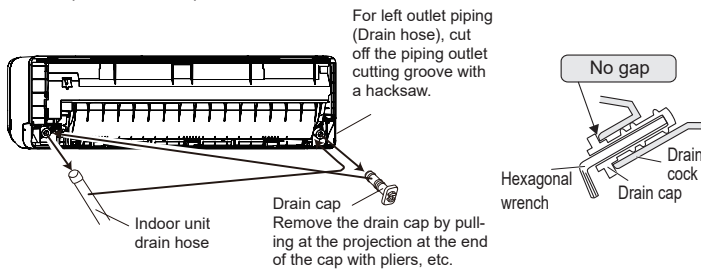

Removing the drain hose

Remove the screw at the left of drain hose and pull out drain hose.

Installing the drain hose

Vertically insert the drain hose toward the inside, so that the drain fixture (white) can accurately align with the screw hole around the drain cock. After inserting and before replacing, Reinstall and fix the removed screws.

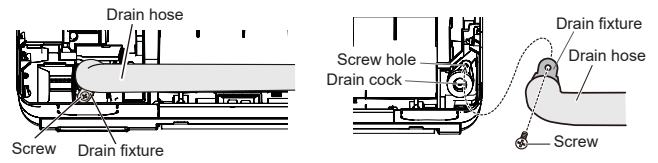

- Hold around the joint of the drain hose during work.
- As the screw is inside, be sure to use screwdrivers treated with magnet.

- After passing the indoor piping and drain hose through the wall hole, hang the indoor unit on the hooks at the top and bottom of the wall hook bracket.

⚠ CAUTION

Insert the drain hose and drain cap into the drain port, making sure that it comes in contact with the back of the drain port, and then mount it. If the drain hose is not connected properly, leaking will occur.

■ Installing the indoor unit

- Hang the indoor unit from the hooks at the top of the wall hook bracket.
- Insert the spacer, etc. within the area(gray insulation) between the indoor unit and the wall hook bracket and separate the bottom of the indoor unit from the wall.

Unit: in (mm)

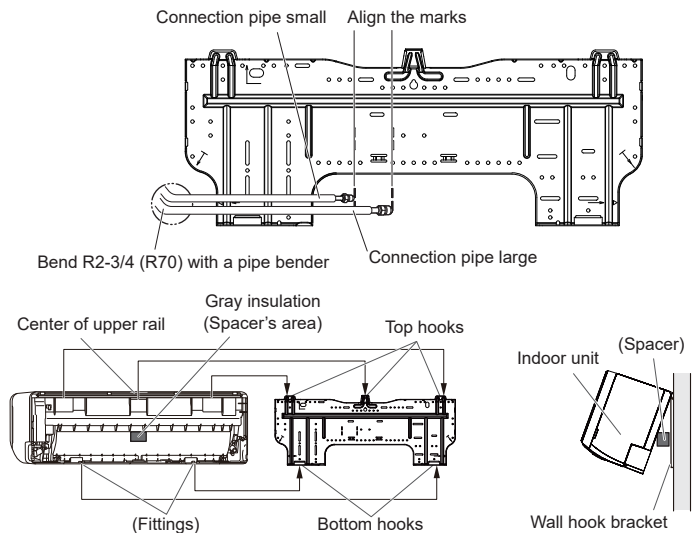

- After hooking the indoor unit to the top hook, hook the fittings of the indoor unit to the bottom hooks while lowering the unit and pushing it against the wall.

3.3.5. Pipe connection

⚠ CAUTION

Tighten the flare nuts with a torque wrench using the specified tightening method. Otherwise, the flare nuts could break after a prolonged period, causing refrigerant to leak and generate hazardous gas if the refrigerant comes into contact with a flame.

■ Flaring

Use special pipe cutter and flare tool exclusive for R410A.

- Cut the connection pipe to the necessary length with a pipe cutter.
- Hold the pipe downward so that cuttings will not enter the pipe and remove any burrs.
- Insert the flare nut (always use the flare nut attached to the indoor unit(s) and outdoor unit respectively) onto the pipe and perform the flare processing with a flare tool. Use the special R410A flare tool, or the conventional flare tool. Leakage of refrigerant may result if other flare nuts are used.
- Protect the pipes by pinching them or with tape to prevent dust, dirt, or water from entering the pipes.

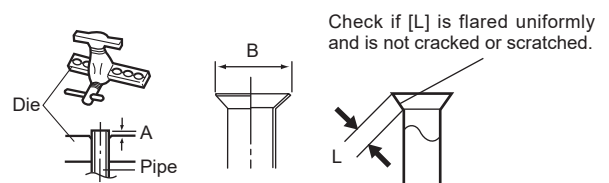

Pipe outside diameter [in. (mm)]	Dimension A [in. (mm)]	Dimension B [in. (mm)]
	Flare tool for R410A, clutch type	
1/4 (6.35)	0 to 0.020 (0 to 0.5)	3/8 (9.1)
3/8 (9.52)		1/2 (13.2)
1/2 (12.70)		5/8 (16.6)
5/8 (15.88)		3/4 (19.7)
3/4 (19.05)		15/16 (24.0)

When using conventional flare tools to flare R410A pipes, the dimension A should be approximately 0.020 in. (0.5 mm) more than indicated in the table (for flaring with R410A flare tools) to achieve the specified flaring. Use a thickness gauge to measure the dimension A.

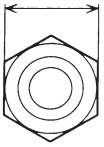
Width across flats	Pipe outside diameter [in. (mm)]	Width across flats of Flare nut [in. (mm)]
	1/4 (6.35)	11/16 (17)
	3/8 (9.52)	7/8 (22)
	1/2 (12.70)	1 (26)
	5/8 (15.88)	1-1/8 (29)
	3/4 (19.05)	1-7/16 (36)

Bending pipes

CAUTION

- To prevent breaking of the pipe, avoid sharp bends.
- If the pipe is bent repeatedly at the same place, it will break.

- The pipes are shaped by your hands. Be careful not to collapse them.
- Bend R2-3/4 in (R70 mm) or more with a pipe bender.
- Do not bend the pipes in an angle more than 90°.
- When pipes are repeatedly bent or stretched, the material will harden, making it difficult to bend or stretch them anymore.
- Do not bend or stretch the pipes more than 3 times.
- When bending the pipe, do not bend it as is. The pipe will be collapsed. In this case, cut the insulating pipe with a sharp cutter as shown on the right, and bend it after exposing the pipe. After bending the pipe as you want, be sure to put the heat insulating pipe back on the pipe, and secure it with tape.

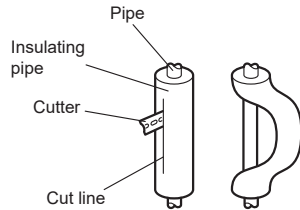

Flare connection

CAUTION

- Be sure to install the pipe against the port on the indoor unit correctly. If the centering is improper, the flare nut cannot be tightened smoothly. If the flare nut is forced to turn, the threads will be damaged.
- Do not remove the flare nut from the indoor unit pipe until immediately before connecting the connection pipe.
- Hold the torque wrench at its grip, keeping it in the right angle with the pipe, in order to tighten the flare nut correctly.
- Tighten the flare nuts with a torque wrench using the specified tightening method. Otherwise, the flare nuts could break after a prolonged period, causing refrigerant to leak and generate hazardous gas if the refrigerant comes into contact with a flame.
- Connect the piping so that the control box cover can easily be removed for servicing when necessary.
- In order to prevent water from leaking into the control box, make sure that the piping is well insulated.

When the flare nut is tightened properly by your hand, hold the body side coupling with a wrench, then tighten with a torque wrench. (Refer to the following table for the flare nut tightening torques.)

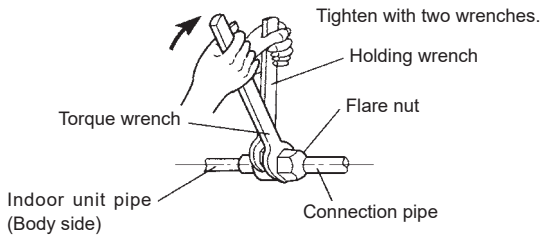

Flare nut [in. (mm)]	Tightening torque [lb-ft (N·m)]
1/4 (6.35) dia.	11.8 to 13.3 (16 to 18)
3/8 (9.52) dia.	23.6 to 31.0 (32 to 42)
1/2 (12.70) dia.	36.1 to 45.0 (49 to 61)
5/8 (15.88) dia.	46.5 to 55.3 (63 to 75)
3/4 (19.05) dia.	66.4 to 81.1 (90 to 110)

3.4. Electrical wiring

WARNING

- Before connecting the wires, make sure the power supply is OFF.
- Every wire must be connected firmly.
- No wire should be allowed to touch refrigerant tubing, the compressor or any moving part.
- Loose wiring may cause the terminal to overheat or result in unit malfunction. A fire hazard may also exist. Therefore, be sure all wiring is tightly connected.
- Connect wires to the matching numbers of terminals.

3.4.1. Wiring system diagram

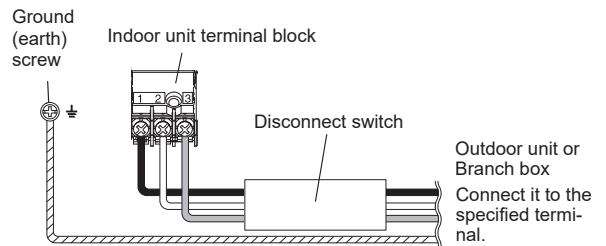
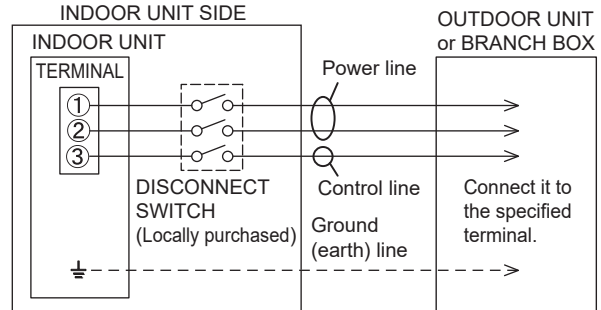

- To connect the indoor unit wires to the terminal correctly, refer to the figure for proper length.

Unit: in (mm)

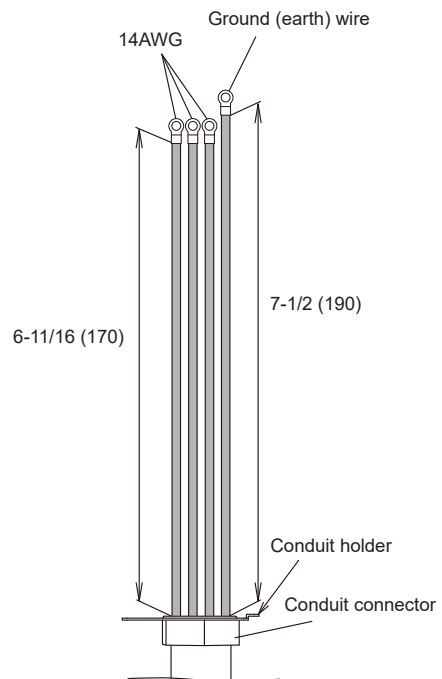

3.4.2. How to the install the connection cable

- (1) Remove the screws, then remove the conduit holder.
- (2) Fasten the indoor unit wire harness to the conduit holder using the lock nut.
IMPORTANT: Refer to "3.4.1. Wiring system diagram" about the length of indoor unit wire harness.
- (3) Use the screws to install the conduit holder provide with the indoor unit.
- (4) Remove the screws, then remove the cable clumper.
- (5) Connect indoor unit wire harness to the terminal.
Refer to "3.4.1. Wiring system diagram".
- (6) Use the screws to install the cable clumper.

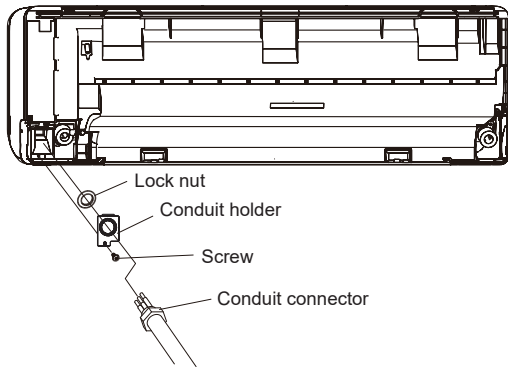

3.4.3. Indoor unit wiring

- (1) Remove the intake grille. (Refer to "3.2.1. Intake grille removal and installation".)
- (2) Remove the tapping screw for the wire cover and the wire cover A.

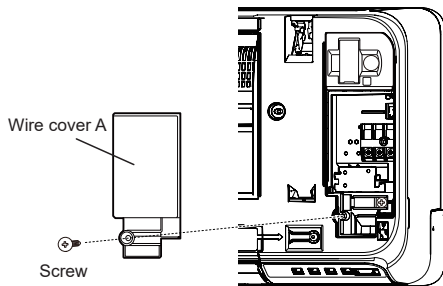

- (3) Remove the tapping screw and while minding the cable clamp hook, remove the cable clamp.

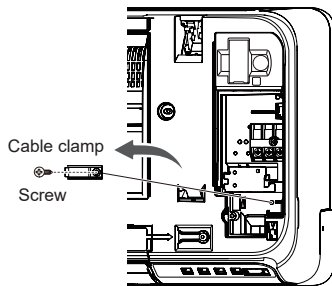

3.4.4. How to connect wiring to the terminals

■ Caution when wiring cable

Caution when wiring cable

When stripping off the insulation of a lead wire, always use a special tool such as a wire stripper. If there is no special tool available, carefully strip the insulation with a knife etc.

- (1) Use ring terminals with insulating sleeves as shown in the following figure to connect to the terminal block.
- (2) Securely clamp the ring terminals to the wires using an appropriate tool so that the wires do not come loose.

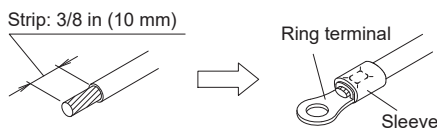

- (3) Use the specified wires, connect them securely, and fasten them so that there is no stress placed on the terminals.
- (4) Use an appropriate screwdriver to tighten the terminal screws. Do not use a screwdriver that is too small, otherwise, the screw heads may be damaged and prevent the screws from being properly tightened.

- (5) Do not tighten the terminal screws too much, otherwise, the screws may break.

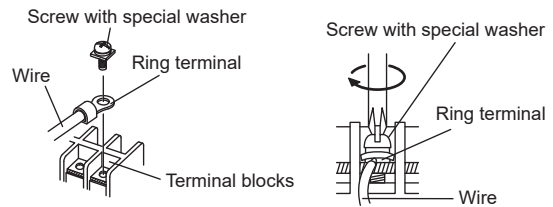

- (6) Refer to the following table for the terminal screw tightening torques.

Tightening torque [lbf-in (N·m)]	
M3.5 screw	7.0 to 8.8 (0.8 to 1.0)
M4 screw	10.6 to 15.9 (1.2 to 1.8)
M5 screw	17.7 to 26.5 (2.0 to 3.0)

⚠ CAUTION

- Attach the cable clamp firmly by holding the connection cable, and make sure that the clamp is fixed securely. Incomplete attachment of the cable clamp might cause a malfunction of the open panel.
- Match the terminal block numbers and connection cable colors with those of the outdoor unit or branch box. Erroneous wiring may cause burning of the electric parts.
- Connect the connection cables firmly to the terminal block. Imperfect installation may cause a fire.
- Always fasten the outside covering of the connection cable with the cable clamp. (If the insulator is chafed, electric discharge may occur.)
- Always connect the ground (earth) wire.
- Do not use the ground (earth) screw of the indoor unit for the connection other than a specified outdoor unit.

- (7) Fix the conduit with the supporters as shown below.

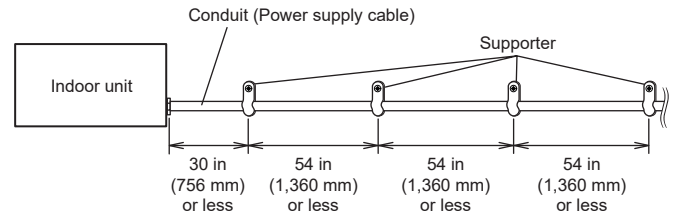

3.5. Remote controller installation

- Check that the indoor unit correctly receives the signal from the remote controller, then install the remote controller holder.

⚠ CAUTION

- Do not install the remote controller holder in the following conditions:
- Any places exposed in direct sunlight
 - Positions affected by the heat from a stove or heater

3.5.1. Remote controller holder installation

- Install the remote controller a maximum distance of 22 ft (7 m) m from the remote control signal receiver. After installing the remote controller, check that it operates correctly.
- Install the remote controller holder to a wall, pillar, etc. with the tapping screw.

Remote controller holder fixing

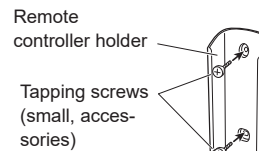

Remote controller mounting

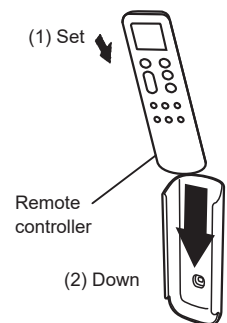

3.5.2. Remote controller custom setting

■ Custom code setting

By setting custom code of indoor unit and remote controller, you can specify the air conditioner which the remote controller controls.

When two or more air conditioners are in the room and you wish to operate them separately, set the custom code (4 selections possible).

NOTE: If custom codes is different between the indoor unit and the remote controller, the indoor unit cannot receive a signal from the remote controller.

How to set the remote controller custom code

- (1) Press until the indicators on the remote controller turn off.
- (2) Press down [MODE] for more than 5 seconds.
The current custom code will be displayed (initially set to).
- (3) Press [TEMP./SELECT ()] to change the custom code between
A () ↔ B () ↔ C () ↔ D ().
* Match the custom code on the display to the air conditioner custom code.
- (4) Press [MODE] again.
The custom code will be set.
The display will return to the original display.

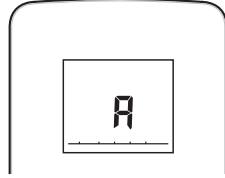

- To change the air conditioner custom code, contact an authorized service personnel (initially set to).
- If you do not press any buttons for 30 seconds after the custom code is displayed, the display returns to the original display. In this case, repeat the setting from step 2.
- Depending on the remote controller, the custom code may return to when replacing the batteries. In this case, reset the custom code as necessary. If you do not know the air conditioner custom code, try each code until you find the code which operates the air conditioner.

4. OPTIONAL INSTALLATION WORK

⚠ CAUTION

- Before installing, be sure to disconnect all power supply.
- Do not touch the heat exchanger.
- When installing or removing parts of the air conditioner, be sure that the wire is not caught by any parts or pulled hard. It may result in damage or malfunction of the air conditioner.

- Connect the cable the circuit board.

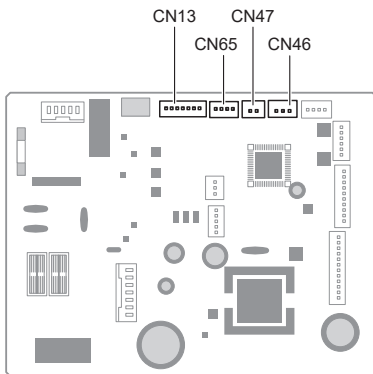

This air conditioner can be connected with the following optional kits. To install these optional kits, the optional External input and output PCB box is necessary.

For details on how to install optional parts, refer to the installation manual included in each item.

Connector No.	Option type
CN13	Wired remote controller (via the Communication kit)
	Simple remote controller (via the Communication kit)
CN46	External input
CN47	External output
CN65	External input and output PCB

4.1. Optional kit installation

NOTE:

- When some wired remote controller is connected, the wireless remote controller cannot be used.

4.1.1. Installing the WLAN adapter

- For installing the WLAN adapter, refer to the operation manual.

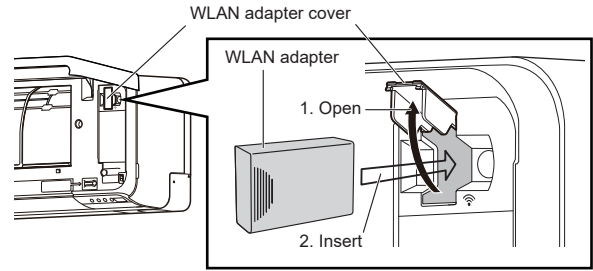

4.1.2. External input and output

■ External input

- Indoor unit functions such as Operation/Stop or Forced stop can be done by using indoor unit terminals.
- "Operation/Stop" mode or "Forced stop" mode can be selected with function setting of indoor unit.
- A twisted pair cable (22 AWG) should be used. Maximum length of cable is 492 ft. (150 m).
- Use an external input and output cable with appropriate external dimension, depending on the number of cables to be installed.
- The wire connection should be separate from the power cable line.

● Dry contact terminal

When a power supply is unnecessary at the input device you want to connect, use the Dry contact terminal.

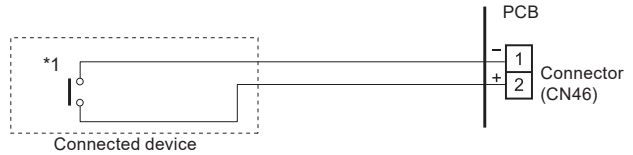

*1: The switch can be used on the following condition: DC 12 V to 24 V, 1 mA to 15 mA.

Operation behavior

● Input signal type



- When function setting is "Operation/Stop" mode 1.

Input signal	Command
OFF → ON	Operation
ON → OFF	Stop

- When function setting is "Forced stop" mode.

Input signal	Command
OFF → ON	Forced stop
ON → OFF	Normal

* When the forced stop is triggered, indoor unit stops and Operation/Stop operation by a remote controller is restricted.

- When function setting is "Operation/Stop" mode 2.

Input signal	Command
OFF → ON	Operation
ON → OFF	Stop (R.C. disabled)

NOTE: For details, refer to "■ External input control" in "5.1. Function details".

■ External output

- A twisted pair cable (22AWG) should be used. Maximum length of cable is 82 ft. (25 m).
- Use an external input and output cable with appropriate external dimension, depending on the number of cables to be installed.
- Output voltage: Hi DC12V±2V, Lo 0V.
- Permissible current: 50mA

Output select

• When interlocking with external device

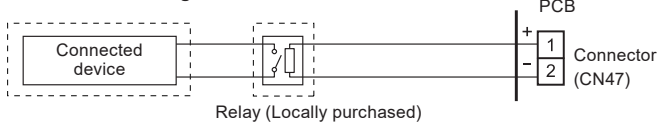

or

• When displaying "Operation/Stop"

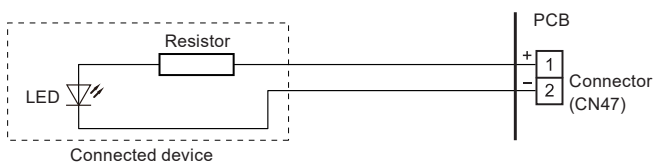

Operation behavior

*If function setting "60" is set to "00", refer to "5. FUNCTION SETTING".

■ Connection methods

Wire modification

- Remove insulation from wire attached to wire kit connector.
- Remove insulation from locally purchased cable. Use crimp type insulated butt connector to join field cable and wire kit wire.
- Connect the wire with connecting wire with solder.

IMPORTANT: Be sure to insulate the connection between the wires.

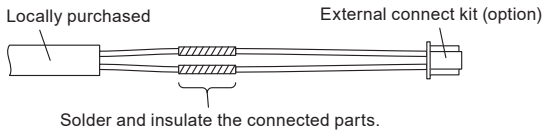

4.1.3. Installing the External input/output PCB

- Remove the Intake grille, front panel, and control cover. Refer to "3.2. Removing and replacing parts".
- Insert the PCB to the clasps (2 places). Push the PCB down until the clasp on the left is set.

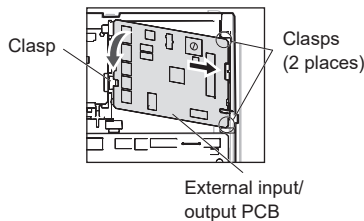

- Hook the WLAN adapter wire to the control box. Fix it with a cable tie.

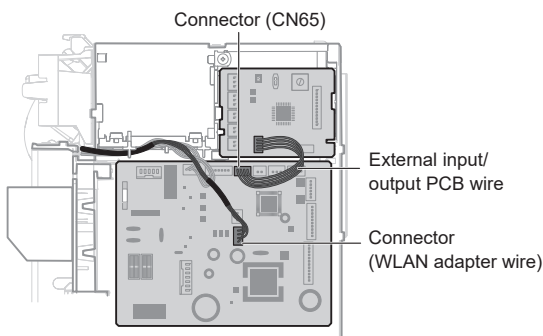

- For the setting of rotary switch and DIP switch, refer to the installation manual of optional parts.

NOTE: If the rotary switch on the "External input and output PCB" is set to "1", function number "46" will operate.

- Replace the control cover, front panel, and Intake grille.
- Refer to "5.1. Function details ■ External input control (Function number 46)" for setting.

4.1.4. Installing the communication kit

- Remove the Intake grille, front panel, and control cover. Refer to "3.2. Removing and replacing parts".
- Insert the PCB to the clasps (2 places). Push the PCB down until the clasp on the bottom is set.

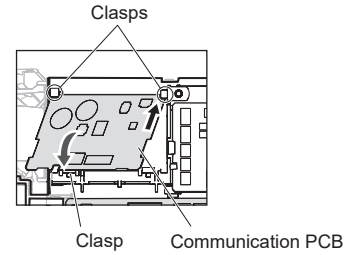

- Attach the terminal board to the indoor unit with 1 screw (accessory for option).
- Connect the connector of wire with EMI core to the communication PCB, then fix it with the cable tie (accessory for option).

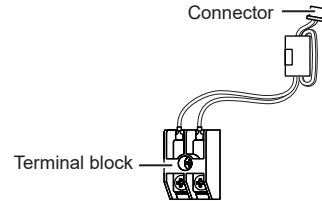

- Connect the communication kit and main PCB.
- Connect the wired remote controller cable to the terminal block as shown in the figure.

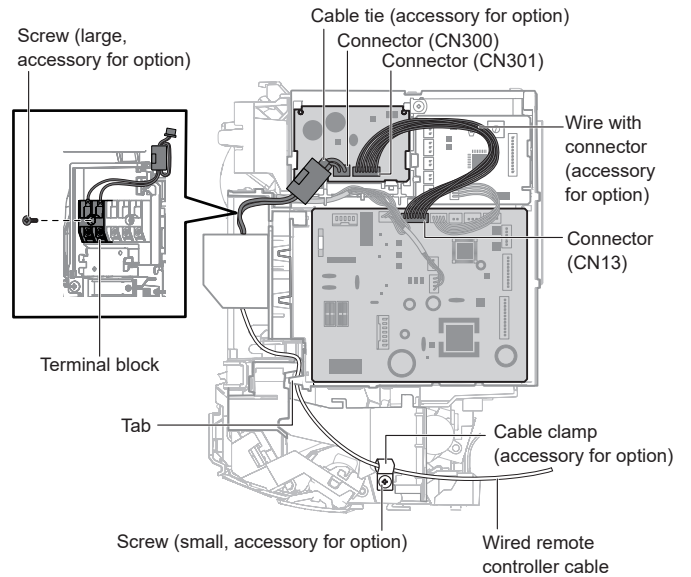

- Replace the control cover, front panel, and Intake grille.

4.2. Group control

NOTE: Group control cannot be used together with WLAN adapter.

4.2.1. Group control system

A number of indoor units can be operated at the same time using a single remote controller. *When different types of indoor units (such as wall mounted type and cassette type, cassette type and duct type, or other combinations) are connected using group control system, some functions may no longer be available.

- Connect up to 16 indoor units in a system.

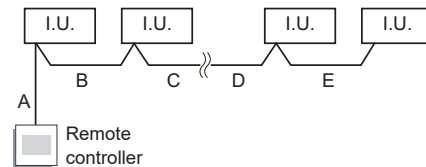

A, B, C, D, E : Remote controller cable.
A+B+C+D+E ≤ 546.8 yd (500 m).

Example of wiring method

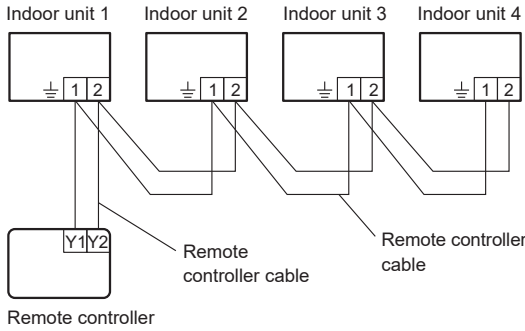

(2) Address automatic setting

- Addresses will be automatically set when initially starting up this unit. In such a case, do not change the remote controller address for the indoor unit.

5. FUNCTION SETTING

Perform the Function setting according to the installation conditions using the remote controller.

CAUTION

- Confirm whether the wiring work for outdoor unit has been finished.
- Confirm that the cover for the electrical enclosure on the outdoor unit is in place.

- This procedure changes to the Function settings used to control the indoor unit according to the installation conditions. Incorrect settings can cause the indoor unit to malfunction.
- After the power is turned on, perform the Function setting according to the installation conditions using the remote controller.
- The settings may be selected between the following two: Function number or setting value.
- Settings will not be changed if invalid numbers or setting values are selected.

Remote controller setting

Entering the function setting mode

While pressing [FAN SPEED] and [TEMP/SELECT (∧∨)] simultaneously, press [RESET] to enter the function setting mode.

STEP 1

Setting the remote controller custom code

Use the following steps to select the custom code of the remote controller. (Note that the air conditioner cannot receive a custom code if the air conditioner has not been set for the custom code.) The custom code that is set through this process are applicable only to the custom in the function setting.

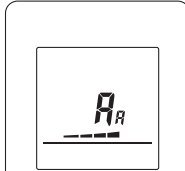

(1) Press [TEMP/SELECT (∧∨)] to change the custom code between A (A) ↔ B (b) ↔ C (c/E) ↔ D (d). Match the code on the display to the air conditioner custom code. (initially set to A) (If the custom code does not need to be selected, press [MODE] and proceed to STEP 2.)

(2) Press [MODE] to accept the custom code, and proceed to STEP 2

The air conditioner custom code is set to A prior to shipment. Contact your retailer to change the custom code.

The remote controller resets to custom code A when the batteries in the remote controller are replaced. If you use a custom code other than custom code A, reset the custom code after replacing the batteries.

If you do not know the air conditioner custom code setting, try each of the custom codes (A (A) ↔ B (b) ↔ C (c/E) ↔ D (d)) until you find the code which operates the air conditioner.

STEP 2

Setting the function number and setting value

- (1) Press [TEMP/SELECT (∧∨)] to select the function number. (Press [MODE] to switch between the left and right digits.)
- (2) Press [FAN SPEED] to proceed to setting the value. (Press [FAN SPEED] again to return to the function number selection.)
- (3) Press [TEMP/SELECT (∧∨)] to select the setting value. (Press [MODE] to switch between the left and right digits.)
- (4) Press [TIMER], then after you hear the beep emitted from the indoor unit, press [ON/OFF] to confirm the settings.
- (5) Press [RESET] to cancel the function setting mode.
- (6) After completing the function setting, be sure to disconnect the power supply and then reconnect it.

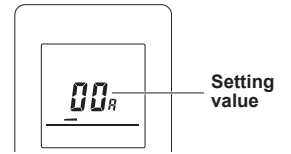
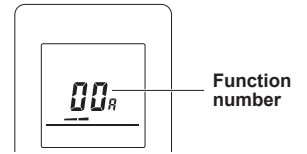

CAUTION

- After disconnecting the power supply, wait 30 seconds or more before reconnecting it.
- The Function Setting will not become active unless the power supply is disconnected and then reconnected.
- When using a custom code other than A, press [RESET] and then press and hold [MODE] again for 5 seconds or more to set the custom code.

5.1. Function details

Filter sign

Select appropriate intervals for displaying the filter sign on the indoor unit according to the estimated amount of dust in the air of the room.

If the indication is not required, select "No indication" (03).

(♦... Factory setting)

Function number	Setting value	Setting description
11	00	Standard (400 hours)
	01	Long interval (1000 hours)
	02	Short interval (200 hours)
	03	No indication

Auto restart

Enable or disable automatic restart after a power interruption.

(♦... Factory setting)

Function number	Setting value	Setting description
40	00	Enable
	01	Disable

* Auto restart is an emergency function such as for power outage etc. Do not attempt to use this function in normal operation. Be sure to operate the unit by remote controller or external device.

Room temperature sensor switching

(Only for wired remote controller)

When using the Wired remote controller temperature sensor, change the setting to "Both" (01).

(♦... Factory setting)

Function number	Setting value	Setting description
42	00	Indoor unit
	01	Both

00: Sensor on the indoor unit is active.

01: Sensors on both indoor unit and wired remote controller are active.

* Remote controller sensor must be turned on by using the remote controller

Remote controller custom code

(Only for wireless remote controller)

The indoor unit custom code can be changed. Select the appropriate custom code.

(♦... Factory setting)

Function number	Setting value	Setting description
44	00	A
	01	B
	02	C
	03	D

External input control

"Operation/Stop" mode or "Forced stop" mode can be selected.
(◆... Factory setting)

Function number	Setting value	Setting description
46	00	Operation/Stop mode 1 (R.C. enabled) ◆
	01	(Setting prohibited)
	02	Forced stop mode
	03	Operation/Stop mode 2 (R.C. disabled)

Room temperature sensor switching (Aux.)

To use the temperature sensor on the wired remote controller only, change the setting to "Wired remote controller" (01). This function will only work if the function setting 42 is set at "Both" (01)
(◆... Factory setting)

Function number	Setting value	Setting description
48	00	Both ◆
	01	Wired remote controller

Indoor unit fan control for energy saving for cooling

Enables or disables the power-saving function by controlling the indoor unit fan rotation when the outdoor unit is stopped during cooling operation.
(◆... Factory setting)

Function number	Setting value	Setting description
49	00	Disable
	01	Enable
	02	Remote controller ◆

00: When the outdoor unit is stopped, the indoor unit fan operates continuously following the setting on the remote controller.

01: When the outdoor unit is stopped, the indoor unit fan operates intermittently at a very low speed.

02: Enable or disable this function by remote controller setting.

*When using a wired remote controller without Indoor unit fan control for energy saving for cooling function, or when connecting a single split converter, the setting cannot be made by using the remote controller. Set to (00) or (01).

To confirm if the remote controller has this function, refer to the operation manual of each remote controller.

Switching functions for external output terminal

Functions of the external output terminal can be switched.
(◆... Factory setting)

Function number	Setting value	Setting description
60	00	Operation status ◆
	01 to 08	Other status (Refer to the Design & technical manual.)
	09	Error status
	10	Interlocked with indoor fans
	11	External heater output

Control switching of external heaters

Sets the control method for the external heater being used. For details of the control method, refer to the Design & Technical Manual.
(◆... Factory setting)

Function number	Setting value	Setting description
61	00	Auxiliary heater control 1 ◆
	01	Auxiliary heater control 2
	02	Heat pump prohibition control
	03	Heater selection control using outdoor temperature 1
	04	Heater selection control using outdoor temperature 2
	05	Auxiliary heater control by outdoor temperature 3
	06	Auxiliary heat pump control
	07	Auxiliary heat pump control by outdoor temperature 1
	08	Auxiliary heat pump control by outdoor temperature 2
09	Auxiliary heat pump control by outdoor temperature 3	

Standby time for auxiliary equipment operation

Sets the standby time until the auxiliary equipment operation starts during primary equipment operation.
(◆... Factory setting)

Function number	Setting value	Setting description
71	00	Disable ◆
	01	1 minutes
	02 to 98	2 minutes to 98 minutes
	99	99 minutes

Heat pump backup setting

Enables or disables the heat pump backup instruction from the outdoor unit. This function will be usable provided that the corresponding outdoor unit is connected.
(◆... Factory setting)

Function number	Setting value	Setting description
72	00	Disable ◆
	01	Enable

Emergency heat for external output terminal

Enables or disables emergency heat input. To use this function, select "External heater output" after entering "Function Number 60". For more information, Refer to the Design & technical manual.
(◆... Factory setting)

Function number	Setting value	Setting description
73	00	Disable ◆
	01	Enable

Setting record

Record any changes to the settings in the following table.

Function number	Setting description	Setting value
11	Filter sign	
40	Auto restart	
42	Room temperature sensor switching	
44	Remote controller custom code	
46	External input control	
48	Room temperature sensor switching (Aux.)	
49	Indoor unit fan control for energy saving for cooling	
60	Switching functions for external output terminal	
61	Control switching of external heaters	
71	Standby time for auxiliary equipment operation	
72	Heat pump backup setting	
73	Emergency heat for external output terminal	

After completing the Function Setting, be sure to disconnect the power supply and then reconnect it.

5.2. Temperature correction

NOTES:

When changing Function 95, perform this setting before other Room temp. control settings (Function 30, 31, 35, 36).

If Function 95 is not set first, Room temperature control settings (Function 30, 31, 35, 36) will be reset and you must re-do them again.

Heat Insulation condition (building insulation)

Heat insulation conditions differ according to the installed environment.

"Standard insulation" (00) allows system to rapidly respond to the cooling or heating load changes.

"High insulation" (01) is when the heat insulation structure of the building is high and does not require system to rapidly respond to cooling or heating load changes.

When "High insulation" (01) is selected;

- Overheating (overcooling) is prevented at the start-up.
- All room temp. control settings (Function 30, 31, 35, 36) will reset to "No correction" [0.0°F (0.0°C)].

(◆... Factory setting)

Function Number	Setting Value	Setting Description
95	00	Standard insulation ◆
	01	High insulation

Room temperature control for indoor unit sensor

Depending on the installed environment, correction of the room temperature sensor may be required.

Select the appropriate control setting according to the installed environment.

The temperature of the room temperature sensor is corrected as follows:

Corrected temp. = Temp. of room temp. sensor - correction temp. value

Example of correction :

When the temperature of room temp. sensor is 78 °F and the setting value is

"03" (-2 °F), the corrected temp. will be 80 °F (78 °F [-2 °F]).

The temperature correction values show the difference from the "Standard setting" (00) (manufacturer's recommended value).

(◆... Factory setting)

Function number	Setting value	Setting description	
30 (For cooling)	31 (For heating)	00	Standard setting
		01	No correction 0 °F (0.0 °C)
		02	-1 °F (-0.5 °C)
		03	-2 °F (-1.0 °C)
		04	-3 °F (-1.5 °C)
		05	-4 °F (-2.0 °C)
		06	-5 °F (-2.5 °C)
		07	-6 °F (-3.0 °C)
		08	-7 °F (-3.5 °C)
		09	-8 °F (-4.0 °C)
		10	+1 °F (+0.5 °C)
		11	+2 °F (+1.0 °C)
		12	+3 °F (+1.5 °C)
		13	+4 °F (+2.0 °C)
		14	+5 °F (+2.5 °C)
		15	+6 °F (+3.0 °C)
		16	+7 °F (+3.5 °C)
17	+8 °F (+4.0 °C)		

Room temperature control for wired remote controller sensor

Depending on the installed environment, correction of the wire remote temperature sensor may be required.

Select the appropriate control setting according to the installed environment.

To change this setting, set Function 42 to "Both" (01).

Ensure that the Thermo Sensor icon is displayed on the remote controller screen.
(◆... Factory setting)

Function number	Setting value	Setting description	
35 (For cooling)	36 (For heating)	00	No correction
		01	No correction 0 °F (0.0 °C)
		02	-1 °F (-0.5 °C)
		03	-2 °F (-1.0 °C)
		04	-3 °F (-1.5 °C)
		05	-4 °F (-2.0 °C)
		06	-5 °F (-2.5 °C)
		07	-6 °F (-3.0 °C)
		08	-7 °F (-3.5 °C)
		09	-8 °F (-4.0 °C)
		10	+1 °F (+0.5 °C)
		11	+2 °F (+1.0 °C)
		12	+3 °F (+1.5 °C)
		13	+4 °F (+2.0 °C)
		14	+5 °F (+2.5 °C)
		15	+6 °F (+3.0 °C)
		16	+7 °F (+3.5 °C)
17	+8 °F (+4.0 °C)		

Setting record

- Record any changes to the settings in the following table.

Function number	Setting Description	Setting Value
95	Heat Insulation condition (building insulation)	
30	Room temperature control for indoor unit sensor	Cooling
31		Heating
35	Room temperature control for wired remote controller sensor	Cooling
36		Heating

After completing the Function setting, be sure to disconnect the power and reconnect it again.

6. TEST RUN

Check items

- Is operation of each button on the remote control unit normal?
- Does each lamp light normally?
- Do air flow direction louvers operate normally?
- Is the drain normal?
- Do not have an abnormal noise and vibration during operation?
- Is there an error left in the error memory?
 - After installation, check that the display is "00 (normal)". (For checking whether the display shows "00", refer to "Service check in the Operation manual".)
 - If the display is other than "00 (normal)" even though it works normally, erase the error memory
 - For "How to check the error memory" and "How to erase the error memory", refer to the lower section of the "9. ERROR CODES" list.
- Do not operate the air conditioner in test run for a long time. (If you leave it as it is after the test run starts, it will end automatically in about 60 minutes.)

Operation method

Before starting the test run, wait for 1 minute after connecting the power supply.

By the wireless remote controller

- To start the test run, press [START/STOP(⏏)], press and hold [FAN] on the remote control for 5 seconds or more by using the tip of a ballpoint pen or other small object. By the indoor unit
- To start the test run, keep on pressing the indoor unit button for more than 10 seconds.
- To end test operation, press the remote controller [START/STOP(⏏)]. (When the air conditioner is running by pressing [FAN], the "OPERATION" Lamp and "TIMER" Lamp will simultaneously flash slowly.)

7. FINISHING

- Insulate between pipes.
 - Insulate suction and discharge pipes separately.
 - For rear, right, and bottom piping, overlap the connection pipe heat insulation and indoor unit pipe heat insulation and bind them with vinyl tape so that there is no gap.
- Temporarily fasten the connection cable along the connection pipe with vinyl tape. (Wrap to about 1/3 the width of the tape from the bottom of the pipe so that water does not enter.)
- Fasten the connection pipe to the outside wall with a saddle, etc.
- Fill the gap between the outside wall pipe hole and the pipe with sealer so that rain water and wind cannot blow in.
- Fasten the drain hose to the outside wall, etc.
- Check the drainage.

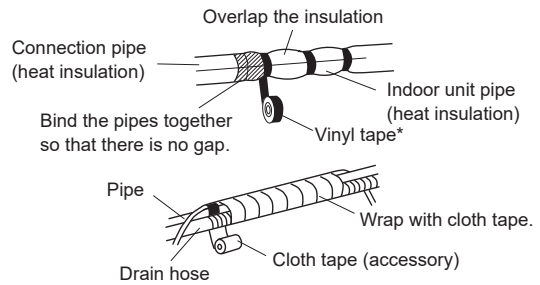
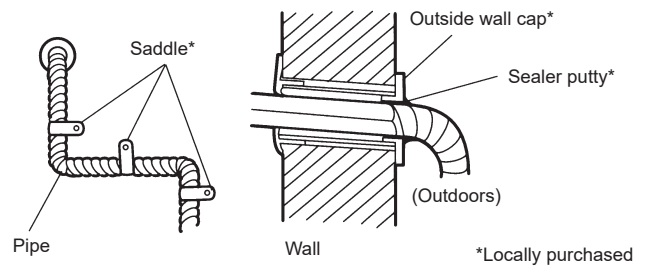

Seal A is used when the diameter of gas pipe is $\varnothing 1/2$ in ($\varnothing 12.70$ mm) or more.

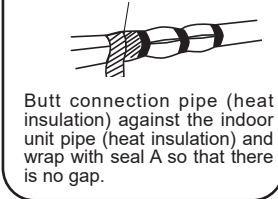

GOOD

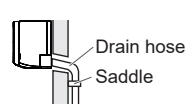

PROHIBITED

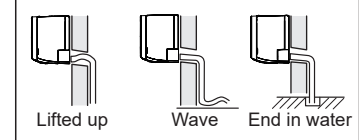

- Open the intake grille of the indoor unit. Set an air cleaning filter (accessories) to each filter folder (accessories) and attach to the air filter. For details of how to assemble the air filter, Refer to the operation manual.

8. CUSTOMER GUIDANCE

Explain the following to the customer in accordance with the operation manual:

- Starting and stopping method, operation switching, temperature adjustment, timer, airflow switching, and other remote control unit operations.
- Air filter removal and cleaning, and how to use the air louvers.
- Give the operation manual to the customer.

9. ERROR CODES

If you use a wireless remote controller, the lamp on the photo detector unit will output error codes by way of blinking patterns. If you use a wired remote controller, error codes will appear on the remote control display. Refer to the lamp blinking patterns and error codes in the table. An error display is displayed only during operation.

The error code table contains errors irrelevant to this product as well.

■ Error display on the indoor unit

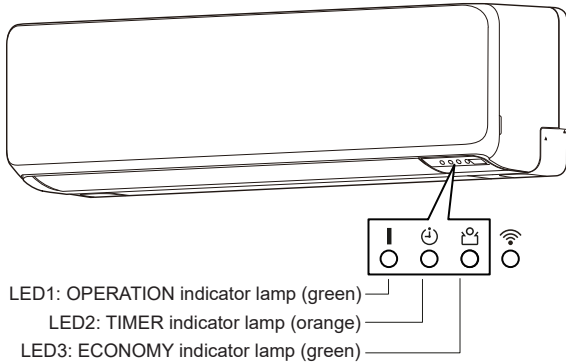

* : For wired remote controller (optional)

Error display			Error code*	Description
LED1 (green)	LED2 (orange)	LED3 (green)		
●(1)	●(1)	◇	11	Serial communication error
●(1)	●(2)	◇	12	Wired remote controller communication error
●(1)	●(5)	◇	15	Check run unfinished Automatic airflow adjustment error
●(1)	●(6)	◇	16	Peripheral unit transmission PCB connection error
●(1)	●(8)	◇	18	External communication error
●(2)	●(1)	◇	21	Unit number or Refrigerant circuit address setting error [Simultaneous multi-split type]
●(2)	●(2)	◇	22	Indoor unit capacity error
●(2)	●(3)	◇	23	Combination error
●(2)	●(4)	◇	24	• Connection unit number error (indoor secondary unit) [Simultaneous multi-split type] • Connection unit number error (indoor unit or branch unit) [Flexible multi-split type]
●(2)	●(6)	◇	26	Indoor unit address setting error
●(2)	●(7)	◇	27	Primary unit, secondary unit setup error [Simultaneous multi-split type]
●(2)	●(9)	◇	29	Connection unit number error in wired remote controller system
●(3)	●(1)	◇	31	Power supply interruption error
●(3)	●(2)	◇	32	Indoor unit PCB model information error
●(3)	●(3)	◇	33	Indoor unit motor electricity consumption detection error
●(3)	●(5)	◇	35	Manual auto switch error
●(3)	●(9)	◇	39	Indoor unit power supply error for fan motor
●(3)	●(10)	◇	3A	Indoor unit communication circuit (wired remote controller) error
●(4)	●(1)	◇	41	Room temp. sensor error
●(4)	●(2)	◇	42	Indoor unit heat ex. middle temp. sensor error
●(4)	●(4)	◇	44	Human sensor error
●(5)	●(1)	◇	51	Indoor unit fan motor error
●(5)	●(3)	◇	53	Drain pump error

Error display			Error code*	Description
LED1 (green)	LED2 (orange)	LED3 (green)		
●(5)	●(4)	◇	54	Electric air cleaner reverse VDD error
●(5)	●(5)	◇	55	Filter set error
●(5)	●(7)	◇	57	Damper error
●(5)	●(8)	◇	58	Intake grille error
●(5)	●(9)	◇	59	Indoor unit fan motor 2 error (Left side fan)
●(5)	●(10)	◇	5A	Indoor unit fan motor 3 error (Right side fan)
●(5)	●(15)	◇	5U	Indoor unit error
●(6)	●(1)	◇	61	Outdoor unit reverse/missing phase and wiring error
●(6)	●(2)	◇	62	Outdoor unit main PCB model information error or communication error
●(6)	●(3)	◇	63	Inverter error
●(6)	●(4)	◇	64	Active filter error, PFC circuit error
●(6)	●(5)	◇	65	• Trip terminal L error • IPM temp error
●(6)	●(8)	◇	68	Outdoor unit rush current limiting resistor temp. rise error
●(6)	●(10)	◇	6A	Display PCB microcomputers communication error
●(7)	●(1)	◇	71	Discharge temp. sensor error
●(7)	●(2)	◇	72	Compressor temp. sensor error
●(7)	●(3)	◇	73	Outdoor unit Heat Ex. liquid temp. sensor error
●(7)	●(4)	◇	74	Outdoor temp. sensor error
●(7)	●(5)	◇	75	Suction Gas temp. sensor error
●(7)	●(6)	◇	76	• 2-way valve temp. sensor error • 3-way valve temp. sensor error
●(7)	●(7)	◇	77	Heat sink temp. sensor error
●(8)	●(2)	◇	82	• Sub-cool Heat Ex. gas inlet temp. sensor error • Sub-cool Heat Ex. gas outlet temp. sensor error
●(8)	●(3)	◇	83	Liquid pipe temp. sensor error
●(8)	●(4)	◇	84	Current sensor error
●(8)	●(6)	◇	86	• Discharge pressure sensor error • Suction pressure sensor error • High pressure switch error
●(9)	●(4)	◇	94	Trip detection
●(9)	●(5)	◇	95	Compressor rotor position detection error (permanent stop)
●(9)	●(7)	◇	97	Outdoor unit fan motor 1 error
●(9)	●(8)	◇	98	Outdoor unit fan motor 2 error
●(9)	●(9)	◇	99	4-way valve error
●(9)	●(10)	◇	9A	Coil (expansion valve) error
●(10)	●(1)	◇	A1	Discharge temp. error
●(10)	●(3)	◇	A3	Compressor temp. error
●(10)	●(4)	◇	A4	High pressure error
●(10)	●(5)	◇	A5	Low pressure error
●(10)	●(11)	◇	AC	Heat sink temp error
●(13)	●(2)	◇	J2	Branch boxes error [Flexible multi-split type]

Display mode ● : 0.5s ON / 0.5s OFF
◇ : 0.1s ON / 0.1s OFF
() : Number of flashing

■ Error code on the wired remote controller (option)

Check the error

1. If an error occurs, an error icon appears on the "Monitor mode screen". Touch the [Status] on the "Monitor mode screen". The "Status" screen is displayed.
2. Touch the [Error Information] on the "Status" screen. The "Error Information" screen is displayed. (If there are no errors, the [Error Information] will not be displayed.)
3. 2-digit numbers correspond to the error code in the table. Touch the [Next page] (or [Previous page]) to switch to other connected indoor units.

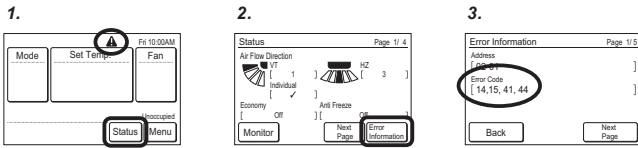

■ How to check the error memory

When an error occurs, the operation lamp (Green) and the timer lamp (Orange) indicate the error content by blinking. To check the error memory, follow the procedures below.

1. Stop the operation of the air conditioner, and then disconnect the power supply.
2. Reconnect the power supply.
3. In one of the following two methods, the memorized error is only displayed during the "3 minutes ST" state period.
 - Start the operation and then press hold [WLAN] on the remote controller for 5 seconds or more.
 - or
 - Press hold [MANUAL AUTO] on the indoor unit for 10 seconds or more.

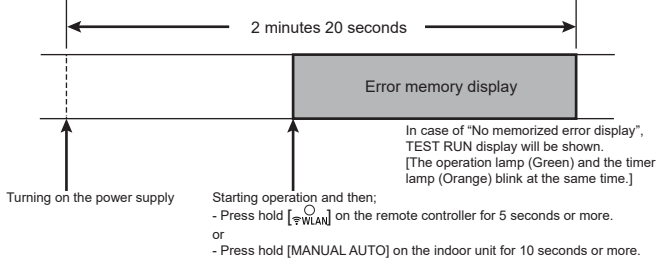

*: The "3 minutes ST" period lasts 2 minutes and 20 seconds after turning on the power supply.

■ How to erase the error memory

- Manual erase: Pressing [MANUAL AUTO] on the indoor unit while the "Error memory display" is being shown. (Short beep emits for about 3 seconds.)