

Circuit Setter Plus®

CALIBRATED BALANCE VALVES

A-508O R2

Circuit Setter Plus Calibrated Manual Balance Valve

The Circuit Setter Plus calibrated balance valve is designed specifically for pre-set proportional system balance. This system balance method, developed and perfected by Bell & Gossett, assures optimum system flow balance at minimum operating horsepower. Lead-Free Circuit Setter Plus valves are perfect for balancing HVAC and potable water systems to minimize pump energy requirements.

- Available in **Lead-Free** brass (1/2" - 3") or cast/ductile iron (2-1/2" - 12")
- Proportional and pre-balance design capabilities.
- Externally adjustable manual balance valve for easy adjustment
- Memory stop indicator
- Positive shut off capability
- Available in compliance with Buy American Act COTS provision

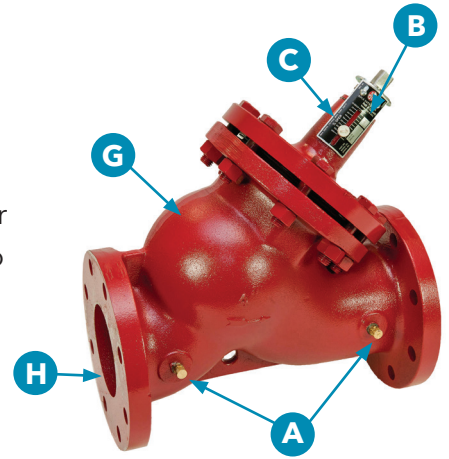

**Flanged / Grooved
4" - 12"**

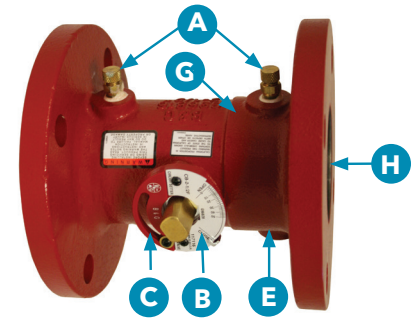

**Flanged Ball Style
2 1/2" - 4"**

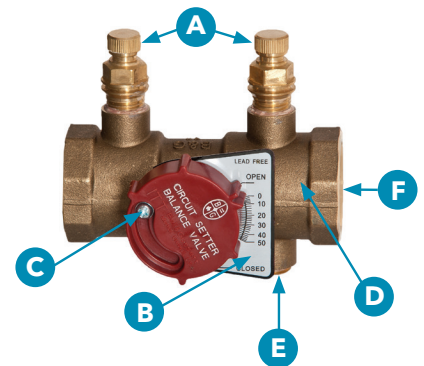

**Circuit Setter Plus
Lead-Free* Brass
1/2" - 3"**

Features	Benefits
A. Integral Valved Read-Out Ports	Facilitates differential pressure readings for proper balance, flow measurement, and easy system commissioning.
B. Calibrated Name Plate	Enables easy and accurate balancing with precise flow setting control.
C. Memory Stop Screw/Button	Allows complete shut-off and return to set position without readjustment or measuring pressure differential again.
D. Lead-Free* Brass Body	Lead-Free* Brass body material in 1/2" - 3" units. Utilizing a carefully calibrated stainless steel ball valve, the Circuit Setter Plus is perfect for balancing potable water applications and small hydronic systems.
E. Drain/Purge Connection	Allows for easy draining of a portion of the system without draining the entire system.
F. Sweat or NPT Connections	With NPT connections available in 1/2" - 3" and Sweat fit connections in 1/2" - 2", the Circuit Setter Plus is a perfect solution for every application. Union fittings available on configured valves.
G. Cast/Ductile Iron Body	Cast Iron body material in all flanged models and ductile iron for all grooved models. Utilizing a carefully calibrated brass ball valve in 2-1/2" - 4" units and a brass seat and disk with EDPM seal insert for a soft seat and thorough seal in 4"-12" units, the Circuit Setter Plus cast/ductile iron units are perfect for hydronic balancing in large pipe diameter applications.
H. Flanged or Grooved Connections	With Flanged connections available in 2-1/2" - 12" and grooved connections in 4"-12", the Circuit Setter Plus is a perfect solution for every large flow application.

* B&G Brass Circuit Setter Plus products are certified by the CSA Group to NSF/ANSI 372 standards to conform to the requirements for "lead free" plumbing products as defined by California, Vermont, Maryland and Louisiana state laws and by Section 1417 of the US Safe Drinking Water Act.

Cost Saving Advantages

The Bell & Gossett Circuit Setter Plus calibrated balance valve has been designed, manufactured and tested to provide the cost saving advantages of pre-set proportional balance. Each valve is a three function precision instrument providing flow balance, flow metering and shut-off.

Velocity Head Recovery

Changes in fluid velocity through the valve orifice are as illustrated. Actual pressure drop imposed against the pump (ΔP from C to D) is on the order .7 to .9 of the value as read across the read-out ports A-B. These differences are significant enough to require two different sets of ΔP data to be shown on the Circuit Setter Balance Valve Calculator.

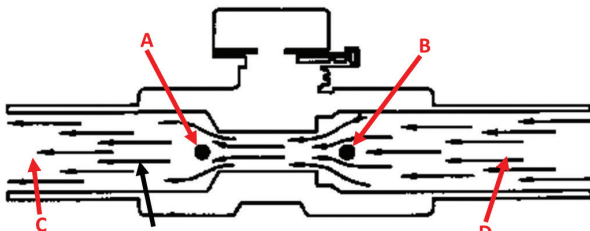

Water flow expands to full pipe size, water velocity is decreased and static pressure is "recovered".

System Syzer Desktop Application

The Circuit Setter System Syzer desktop application is a convenient and easy way to utilize the information on a Circuit Setter Balance Valve Calculator. The application can determine either flow rate based on head loss and valve setting, or the valve setting necessary based on head loss and flow rate across the valve. The unit of measurement can be changed between SI and English units, and fluid makeups of water, Ethylene Glycol, Propylene Glycol, or a custom fluid composition are available.

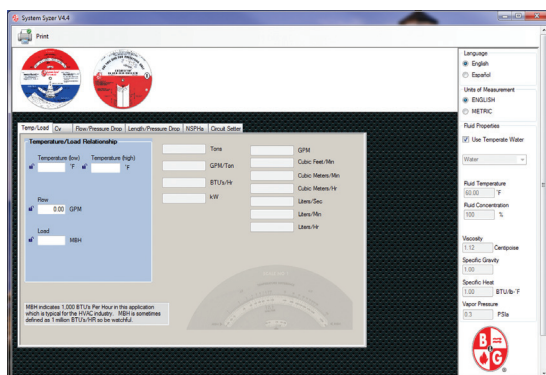

Circuit Setter Balance Valve Calculator

The Circuit Setter Calculator is the result of rigorous laboratory tests. Side 1 plots actual system imposed head loss versus flow for various valve settings. This scale is used for pre-set balance determination. Side 2 is used when taking gauge readings across the Circuit Setter balance valve using the valve as a flow meter.

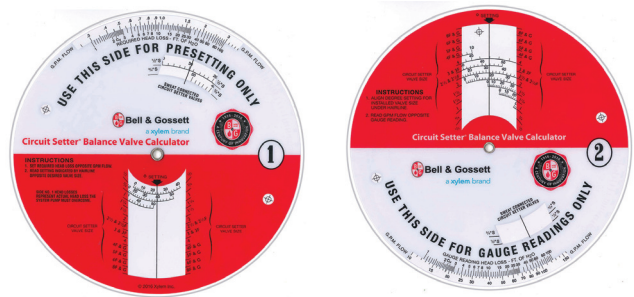

System Syzer Phone App

Available for iPad, iPhone, or Android operating systems, the Circuit Setter System Syzer phone application is a convenient and easy way to utilize the System Syzer app while out in the field. This application can perform all the same duties as the desktop application, but is perfect for setting a valve out in the field, or determining flow rates based on pressure drop and valve setting.

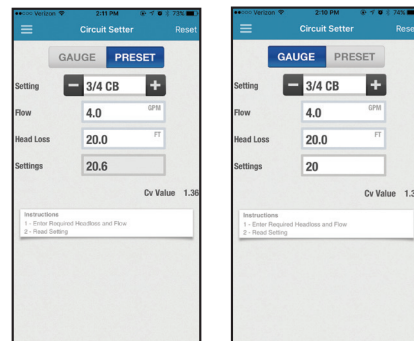

Variable Orifice Flow Meter

Circuit Setter balance valves can be used as a variable orifice flow meter. A differential pressure meter is applied directly across the valved read-out ports. Determine flow rate by using Side 2 of the Circuit Setter Calculator.

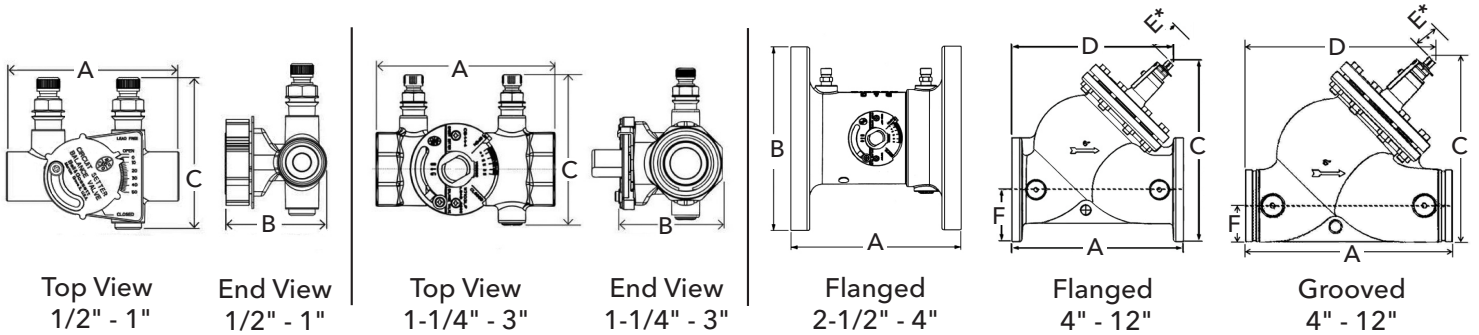

*Distance required to disassemble (valve closed)

Technical Data

DIMENSIONS IN INCHES** (mm)

Model Number	Size	Conns	A	B	C			D		E	F	Max Width Of Valve	Weight in lbs. (KG)	
					Normal	Open	Closed	Open	Closed					
RF-1/2S LF	1/2	Sweat	2.91 (73.9)	1.82 (46.2)	2.85 (72.4)	-	-	-	-	-	-	-	0.6 (0.27)	
RF-3/4S LF	3/4		3.51 (89.2)	2.05 (52.1)	3.10 (78.7)	-	-	-	-	-	-	-	0.75 (0.34)	
CB-1/2S LF	1/2		2.91 (73.9)	1.82 (46.2)	2.85 (72.4)	-	-	-	-	-	-	-	1 (0.45)	
CB-3/4S LF	3/4		3.51 (89.1)	2.05 (52.1)	3.10 (78.7)	-	-	-	-	-	-	-	1.25 (0.6)	
CB-1S LF	1		4.29 (109)	2.33 (59.2)	3.33 (84.6)	-	-	-	-	-	-	-	2 (0.9)	
CB-1-1/4S LF	1-1/4		4.91 (124.7)	3.08 (78.2)	3.69 (93.7)	-	-	-	-	-	-	-	3.5 (1.6)	
CB-1-1/2S LF	1-1/2		5.21 (132.3)	3.27 (83)	3.95 (100.2)	-	-	-	-	-	-	-	3.8 (1.7)	
CB-2S LF	2		6.31 (160.3)	3.83 (97.4)	4.44 (112.8)	-	-	-	-	-	-	-	6.2 (2.8)	
CB-1/2 LF	1/2		2.94 (74.7)	1.98 (50.3)	3.02 (76.7)	-	-	-	-	-	-	-	1.25 (0.6)	
CB-3/4 LF	3/4		3.06 (77.7)	2.17 (55.1)	3.12 (79.2)	-	-	-	-	-	-	-	1.5 (0.7)	
CB-1 LF	1		3.81 (96.8)	2.47 (62.7)	3.42 (86.9)	-	-	-	-	-	-	-	2 (0.9)	
CB-1-1/4 LF	1-1/4		NPT	4.41 (112)	3.19 (81)	3.69 (93.7)	-	-	-	-	-	-	-	3.5 (1.6)
CB-1-1/2 LF	1-1/2	4.42 (112.3)		3.37 (85.6)	3.95 (100.2)	-	-	-	-	-	-	-	3.8 (1.7)	
CB-2 LF	2	5.13 (130.3)		3.98 (101.1)	4.44 (112.8)	-	-	-	-	-	-	-	6.2 (2.8)	
CB-2-1/2 LF	2-1/2	6.00 (152.4)		4.51 (114.6)	4.83 (122.6)	-	-	-	-	-	-	-	9 (4.1)	
CB-2-1/2F		Flgd.		6.56 (166.7)	7 (177.8)	-	-	-	-	-	-	-	-	23 (10.4)
CB-3 LF	3	NPT		6.50 (165.1)	5.12 (130)	5.44 (138.2)	-	-	-	-	-	-	-	12 (5.4)
CB-3F		Flgd.		6.81 (173)	7.5 (190.5)	-	-	-	-	-	-	-	-	29 (13.2)
CB-4	4	Flgd.		8 (203.2)	9 (228.6)	-	-	-	-	-	-	-	-	41 (18.5)
CB-4F		Grvd.		14.50 (368.3)	-	-	16.88 (428.6)	15.88 (403.2)	15.69 (398.5)	13.94 (354)	6.25 (158.8)	4.50 (114.3)	9 (228.6)	94 (43)
CB-4G	Grvd.	15.13 (384.2)		-	-	14.63 (371.5)	13.63 (346.1)	15.69 (398.5)	13.94 (354)	6.88 (174.6)	2.25 (57.2)	10 (254)	70 (32)	
CB-5F	5	Flgd.		16 (406.4)	-	-	18.50 (470)	17.25 (438.2)	16.84 (427.8)	15.06 (382.6)	8.25 (209.6)	5 (127)	11 (279.4)	114 (52)
CB-5G		Grvd.		17.13 (435)	-	-	16.28 (413.5)	15.03 (407.2)	17.34 (440.5)	15.56 (395.3)	10.38 (263.5)	2.78 (70.6)	14.25 (362)	86 (39)
CB-6F	6	Flgd.	18 (457.2)	-	-	20.75 (527.1)	19.25 (489)	19.13 (485.8)	17 (431.8)	12.25 (311.2)	5.50 (139.7)	17 (431.8)	186 (85)	
CB-6G		Grvd.	19 (482.6)	-	-	18.56 (471.5)	17.06 (433.4)	19.50 (495.3)	17.41 (442.1)	14.50 (368.3)	3.31 (84.1)	20 (508)	160 (73)	
CB-8F	8	Flgd.	21.50 (546.1)	-	-	24.75 (628.7)	23.25 (590.6)	22.38 (568.3)	20.31 (516)	14.50 (368.3)	6.75 (171.5)	20 (508)	316 (144)	
CB-8G		Grvd.	22.50 (571.5)	-	-	22.31 (566.7)	20.81 (528.6)	22.38 (568.3)	20.31 (516)	14.50 (368.3)	4.31 (109.5)	20 (508)	270 (123)	
CB-10F	10	Flgd.	25.50 (647.7)	-	-	28.88 (733.4)	26.50 (673.1)	26 (660.4)	23.19 (589)	14.50 (368.3)	8 (203.2)	20 (508)	458 (208)	
CB-10G		Grvd.	26.50 (673.1)	-	-	26.25 (666.8)	23.88 (606.4)	26.03 (661.2)	23.19 (589)	14.50 (368.3)	5.38 (136.5)	20 (508)	384 (174)	
CB-12F	12	Flgd.	30 (762)	-	-	33.50 (851.0)	31.13 (790.6)	29.69 (754.1)	26.94 (684.2)	14.50 (368.3)	9.50 (241.3)	20 (508)	662 (301)	
CB-12G		Grvd.	31 (787.4)	-	-	30.38 (771.5)	28 (711.2)	30.44 (773.1)	26.94 (684.2)	14.50 (368.3)	6.38 (161.9)	20 (508)	546 (248)	

**All dimensions are +/- 0.125" (3.2 mm) tolerance. Dimensions are subject to change without notice. Not to be used for construction purposes unless certified.



Xylem Inc.
 8200 N. Austin Avenue
 Morton Grove, Illinois 60053
 Phone: (847) 966-3700
 Fax: (847) 965-8379
www.xylem.com/bellgossett

Xylem, Bell & Gossett, and Circuit Setter are trademarks or registered trademarks of Xylem, Inc. or one of its subsidiaries. All other trademarks are property of their respective owners.
 © 2022 Xylem Inc. A-508O R2 November 2022