

1730

OLDCASTLE POLYMER

(formerly H-Series)

COVER

- Style: Flush Solid
- Material: Polymer Concrete
- Model: 17" x 30"
- Weight: Tier 15: 62 lbs.
Tier 22: 85 lbs.
- Std. Fasteners: 1/2-13 Stainless Steel Hex Head Bolt, Washer and Floating Nut
- Options: Logos and Special Markings
- Surface: Slip Resistant
- Performance: ANSI/SCTE-77, Tier 15 or Tier 22*

Cover comes standard with permanent markings for manufacturer, load rating, model size and manufacturing location.

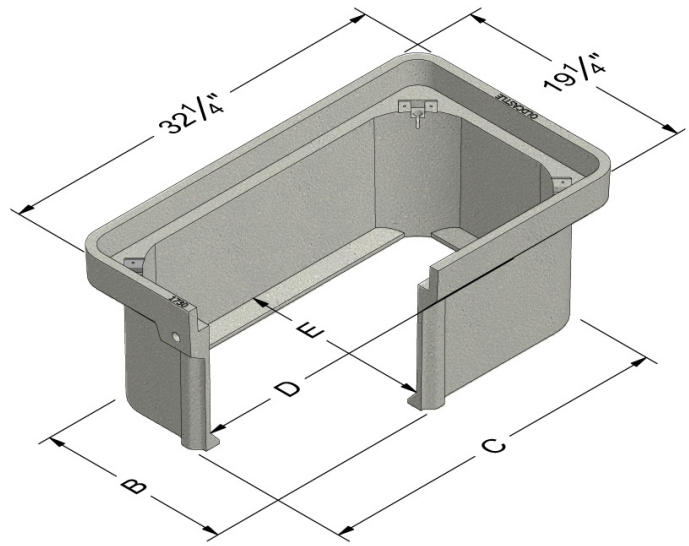
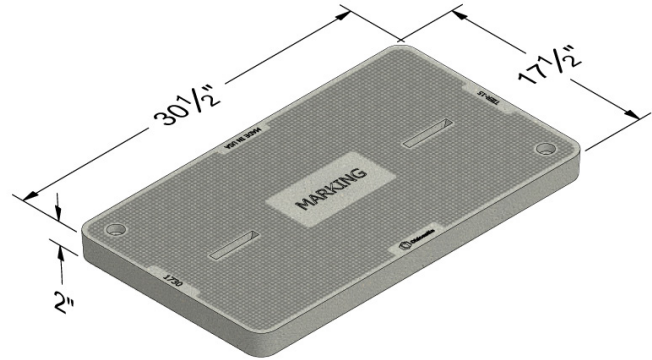

BODY

- Material: Polymer Concrete
- Model: 17" x 30"
- Weight: 12" Depth: 65 lbs.
18" Depth: 88 lbs.
24" Depth: 114 lbs.
- Wall Type: Straight
- Performance: ANSI/SCTE-77 Tier 22

LOAD RATING / NOTES



MEDIUM DUTY
ANSI/SCTE TIER 15



HEAVY DUTY
ANSI/SCTE TIER 22

For use in non-vehicular traffic situations only. Weights and dimensions may vary slightly. Actual load rating is determined by the box and cover combination.

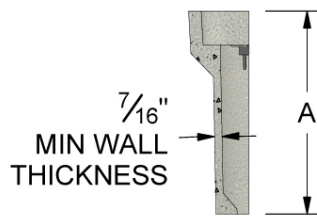

1 1/4" FOOTING

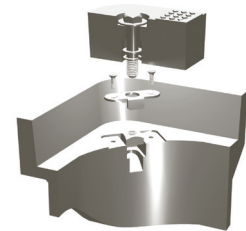

Bolt Down Detail

	A	B	C	D	E
1730-12	12	17-1/4	30-1/4	28-3/16	15-3/16
1730-18	18	17-1/8	30-1/8	28	15
1730-24	24	17	30	27-3/4	14-3/4

* Based upon lid and body combination, this unit can be Tier 15 or Tier 22. T22 rating when paired with T22 polymer concrete lid.

1730

OLDCASTLE POLYMER

(formerly H-Series)

COVER OPTIONS

- Oldcastle Polymer, Flush Solid
- Oldcastle Polymer, Flush 2-Piece
- Oldcastle Polymer, Flush Pedestal Provision
- Steel, Solid



Polymer
Solid



Steel
Solid

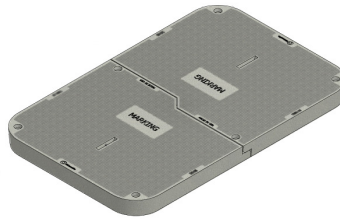

Polymer
2-Piece

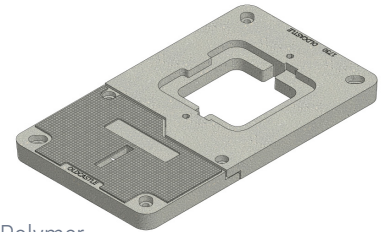

Polymer
Pedestal Provision

FASTENER OPTIONS

- Hex Head Bolt (A)
- Penta Head Bolt (B)
- Penta Head Coil Thread Bolt (B)
- Oldcastle Vandal Resistant Bolt (C)
- Captive Bolt Retainer



Standard Thread



A



B



C



Coil Thread



Bolt Retainer
(for standard thread)

ADD ON OPTIONS

- EMS Marker
- Mouseholes/Knockouts
- Rack Mount
- Cable Racks/Cable Arms
- Unistrut
- Pulling Eye - 1,000 lb and 3,000 lb
- Ground Buss
- Dividers
- Racking Provision
- Lid Gaskets*
- Solid Bottom
- Custom Marking Plate (Polymer)



Rack Mount



Cable Rack
Cable Arm



Unistrut

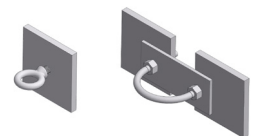

Pulling Eye



EMS Marker



Ground Bus

* Lid Gaskets inhibit water flow into the box, they do not make enclosure fully waterproof.

WARNING: Cancer - www.P65Warnings.ca.gov

All information contained on this sheet is current at the time of publication.
Oldcastle reserves the right to discontinue or update product information without notice.

Revision 11/09/18
© 2018 Oldcastle Infrastructure