

VILAMONTE WATERFALL VESSEL FAUCET

SKU: 948607

Code: SHWSCVL157L



FEATURES

Material: Metal construction for strength and durability

Installation Type: Vessel

Flow Rate: 1.2 gpm (4.5 L/min) @ 60 psi

Cartridge Type: Ceramic Disc

Swivel Spout: No

Drain Type: Metal push-pop with overflow

ASME A112.18.1/CSA B125.1, NSF/ANSI 372, NSF/ANSI 61, NSF/ANSI/CAN 61, NSF/ANSI/CAN 61-9:Q≤1, ICC/ANSI A117.1, CEC Listed, WaterSense by IAPMO, Massachusetts Accepted, LISTED ID: SHWSCVL157L*



ADDITIONAL FEATURES

- Drain is only compatible with sinks that have an overflow.

REVISED 6/21/2024

VILAMONTE WATERFALL VESSEL FAUCET

SKU: 948607

Code: SHWSCVL157L

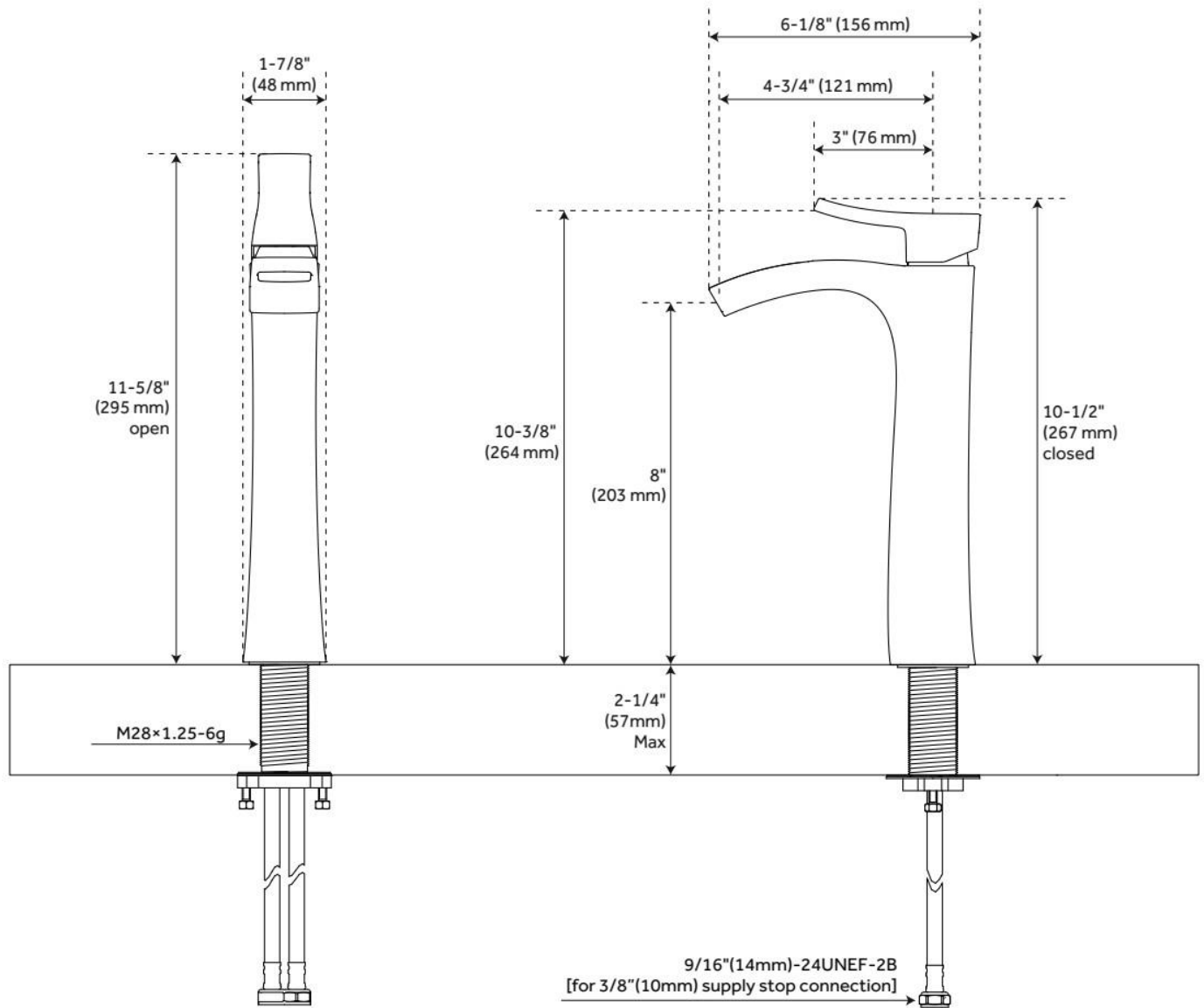

REVISED 6/21/2024

VILAMONTE WATERFALL VESSEL FAUCET

SKU: 948607

Code: SHWSCVL157L



REVISED 6/21/2024