

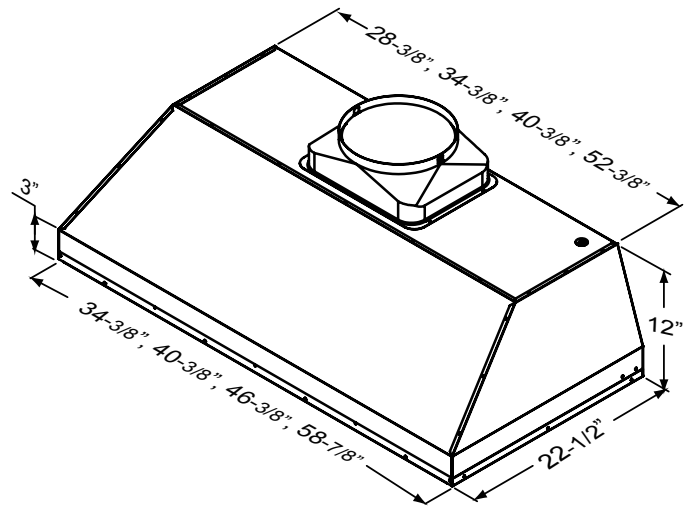

48" model

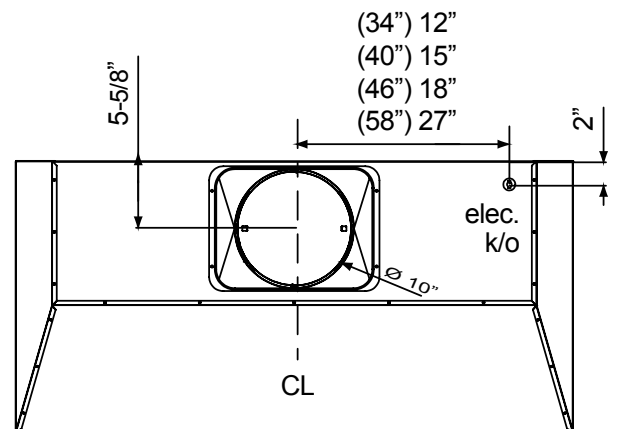

FRONT



TOP

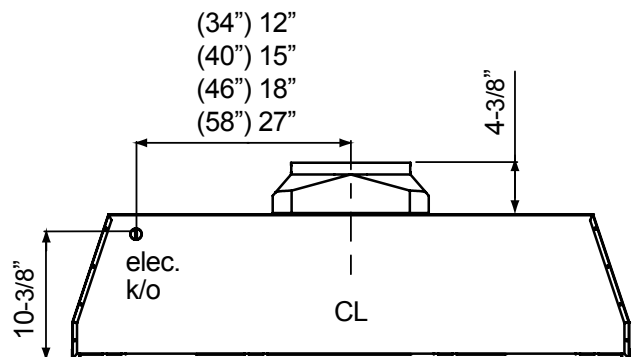

BACK

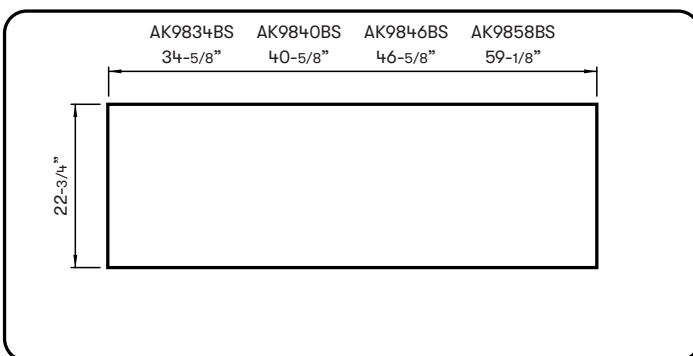

Cabinet Bottom Cut-Out Size (W x D): 34-5/8" x 22-3/4" (AK9834BS), 40-5/8" x 22-3/4" (AK9840BS), 46-5/8" x 22-3/4" (AK9846BS), 59-1/8" x 22-3/4" (AK9858BS)

MODEL				
Stainless Steel	AK9834BS	AK9840BS	AK9846BS	AK9858BS
Size	36" (34-3/8" x 22-1/2")	42" (40-3/8" x 22-1/2")	48" (46-3/8" x 22-1/2")	60" (58-7/8" x 22-1/2")
BLOWER PERFORMANCE				
Blower CFM (Min. - Max.)	450 - 1,200	450 - 1,200	450 - 1,200	450 - 1,200
Sones (Min. - Max.)	3.5 - 9	3.5 - 9	3.5 - 9	3.5 - 9
FEATURES				
Controls	Metallic Knob	Metallic Knob	Metallic Knob	Metallic Knob
Speed Levels	3	3	3	3
Lighting	LumiLight LED, 6W x4	LumiLight LED, 6W x4	LumiLight LED, 6W x4	LumiLight LED, 6W x4
Dual-Level Lighting	Yes	Yes	Yes	Yes
Filters	Pro Baffle x2	Pro Baffle x2	Pro Baffle x3	Pro Baffle x3
Recirculating Option	No	No	No	No
High Quality Stainless Steel	304S	304S	304S	304S
Removable Grease Tray	Yes	Yes	Yes	Yes
DUCT SPECIFICATIONS				
Vertical Internal Blower	10" Round	10" Round	10" Round	10" Round
Horizontal Internal Blower	NA	NA	NA	NA
AC POWER	120V, 60Hz at Max. 6.5A	120V, 60Hz at Max. 6.5A	120V, 60Hz at Max. 6.5A	120V, 60Hz at Max. 6.5A
MOUNTING HEIGHT RANGE*				
	30" - 36"	30" - 36"	30" - 36"	30" - 36"
WARRANTY				
	3 years parts, 1 year labor	3 years parts, 1 year labor	3 years parts, 1 year labor	3 years parts, 1 year labor

*Mounting height refers to distance between top of a 36" tall cooking surface and bottom of hood.