

Installation Instructions and Use & Care Guide

Hybrid Electric Heat Pump Water Heater

DO NOT RETURN THIS UNIT TO THE STORE



Read this manual and the labels on the water heater before you install, operate, or service it. If you have difficulty following the directions, or aren't sure you can safely and properly do any of this work yourself:

- Call your Local plumbing supplies store to have this water heater installed. Professional Installation is available for this product and the work is guaranteed.
- Schedule an appointment with a qualified person to install your water heater.
- Call our Technical Assistance Hotline at **1-800-527-1953**. We can help you with installation, operations, troubleshooting, or maintenance. Before you call, write down the model and serial number from the water heater's data plate.

Incorrect installation, operation, or service can damage the water heater, your house and other property, and present risks including fire, scalding, electric shock, and explosion, causing serious injury or death.

AHRI Certification® applies to residential electric water heaters with rated capacities of 20 to 120 gallon and input ratings of 12 kw or less.

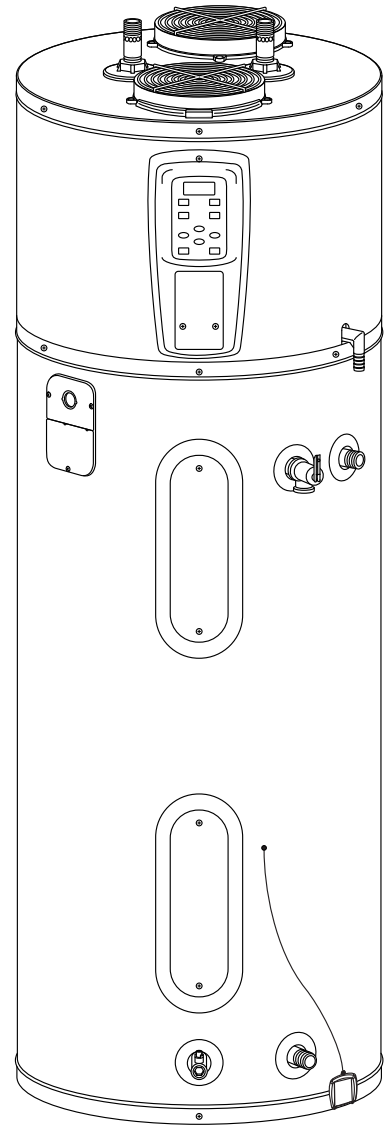

Table of Contents.....	Page
Important Safety Information	3
Getting Started	6
Installation.....	7
Operation	19
Troubleshooting	25
Maintenance	32
Diagrams.....	37
Repair Parts	38



Keep this manual in the pocket on heater for future reference whenever maintenance, adjustment or service is required.

Retain your original receipt as proof of purchase.

COMPLETED INSTALLATION (TYPICAL)

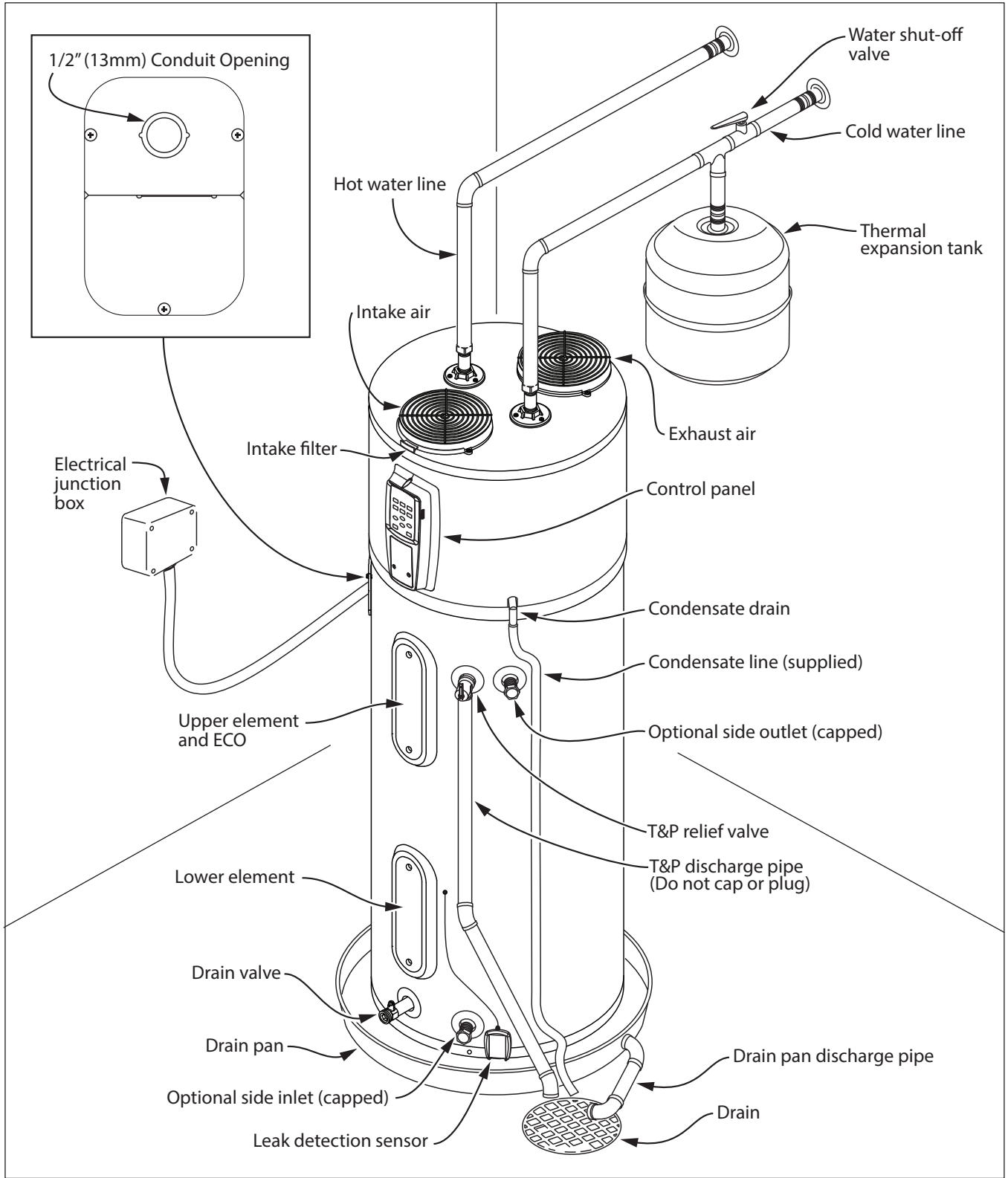





Notes:

- 1) If copper piping is used, then unions must be dielectric at inlet and outlet.
- 2) Plumb piping to desired inlet and outlet, either top or side (not in combination), and cap unused inlet and outlet to avoid water leaks.

IMPORTANT SAFETY INFORMATION

Read and follow all safety messages and instructions in this manual.

	<p>This is the safety alert symbol. It is used to alert you to potential physical injury hazards. Obey all safety messages that follow this symbol to avoid possible property damage, serious injury or death. Do not remove any permanent instructions, labels, or the data plate from either the outside of the water heater or on the inside of the access panels. Keep this manual near the water heater.</p>
---	---

 DANGER	<p>DANGER indicates hazardous situation that, if not avoided, will result in death or serious injury.</p>
 WARNING	<p>WARNING indicates a hazardous situation that, if not avoided, could result in death or serious injury.</p>
 CAUTION	<p>CAUTION indicates a hazardous situation that, if not avoided, could result in minor or moderate injury.</p>
NOTICE	<p>NOTICE indicates practices not related to physical injury.</p>

This product is certified to comply with a maximum weighted average of 0.25% lead content as required in some areas.

Important information to keep

Fill out this section and keep this manual in the pocket of the water heater for reference.

Date Purchased:

Model number:

Serial number:

Maintenance performed:*	Date:
_____	_____
_____	_____
_____	_____
_____	_____
_____	_____
_____	_____

*Drain and flush tank, clean air filter, clean condensate pan, and remove and inspect anode rod after first six months of operation and at least annually thereafter. Operate the Temperature and Pressure Relief Valve (T&P) annually and inspect T&P valve every 2-4 years (see the label on the T&P valve for maintenance schedule). If no label is attached to the T&P Relief Valve, follow the instructions in the T&P Relief Valve Maintenance section of this manual. See the Maintenance section for more information about maintaining this water heater.

IMPORTANT SAFETY INFORMATION

To reduce the risk of property damage, serious injury or death, read and follow the precautions below, all labels on the water heater, and the safety messages and instructions throughout this manual.

RISKS DURING INSTALLATION AND MAINTENANCE



Electric Shock Risk

Contact with the electrical parts in the junction box, behind the access doors and inside the top shroud can result in severe injury or death from the electrical shock.

- Disconnect power by opening the circuit breaker or removing the fuses before installing or servicing.
- Use a non-contact circuit tester to confirm that power is off before working on or near any electrical parts.
- Replace the junction box cover and access doors after servicing.



Lifting Risk

▲ WARNING! The water heater is heavy. Follow these

precautions to reduce the risk of property damage, injuries from lifting or impact injuries from dropping the water heater.

- Use at least two people to lift the water heater.
- Be sure you both have a good grip before lifting.
- Unit is top heavy, use an appliance dolly (with strap) to move the water heater.

RISKS DURING OPERATION



Scalding Risk

This water heater can make water hot enough to cause severe burns instantly, resulting in severe injury or death.

Feel water before bathing or showering.

To reduce the risk of scalding, install Thermostatic Mixing Valves (temperature limiting valves) at each point-of-use. These valves automatically mix hot and cold water to limit the temperature at the tap. Mixing valves are available from your local plumbing supplier. Follow manufacturer's instructions for installation and adjustment of the valves.

The Control Assembly on this water heater has been factory set to approximately 120°F/49°C to reduce the risk of scalding. Higher temperatures increase the risk of scalding, but even at 120°F/49°C, hot water can scald. If you choose a higher temperature, Thermostatic Mixing Valves located at each point-of-use are particularly important to help avoid scalding.

Temperature	Time to Produce a Serious Burn
120°F (49°C)	More than 5 minutes
125°F (52°C)	1½ to 2 minutes
130°F (54°C)	About 30 seconds
135°F (57°C)	About 10 seconds
140°F (60°C)	Less than 5 seconds
145°F (63°C)	Less than 3 seconds
150°F (66°C)	About 1½ seconds
155°F (68°C)	About 1 second

For more information about changing the factory thermostat setting(s), refer to the "Adjusting the Temperature" section in this manual (see page 18).

Regardless of the water heater Control Assembly setting, higher temperatures may occur in certain circumstances:

- In some cases, repeated small draws of water can cause the hot and cold water in the tank to "stack" in layers. If this happens, the water can be as much as 30°F/15°C degrees hotter than the thermostat setting. This temperature variation is the result of your usage pattern and is not a malfunction.
- Water temperature will be hotter if someone adjusted the thermostat(s) to a higher setting.
- Problems with the thermostat(s), or other malfunctions may result in higher than expected water temperatures.
- If the water heater is in a hot environment, the water in the tank can become as hot as the surrounding air, regardless of the thermostat setting.
- If the water supplied to the water heater is pre-heated (for example, by a solar water heating system) the temperature in the tank may be higher than the water heater's thermostat setting.

To reduce the risk of unusually hot water reaching the fixtures in the house, install Thermostatic Mixing Valves at each point-of-use.

IMPORTANT SAFETY INFORMATION

If anyone in your home is at particular risk of scalding (for example, the elderly, children, or people with disabilities) or if there is a local code or state law requiring a certain water temperature at the hot water tap, then these precautions are particularly important.

According to the national standard American Society of Sanitary Engineering (ASSE 1070) and most local plumbing codes, the water heater's thermostat should not be used as the sole means to regulate water temperature to avoid scalds.

Properly adjusted Thermostatic Mixing Valves installed at each point-of-use allow you to set the tank temperature to a higher setting without increasing risk of scalds. A higher temperature setting allows the tank to provide much more hot water and can help provide proper water temperatures for appliances such as dishwashers and washing machines. Higher tank temperatures (140°F/60°C) also kill bacteria that cause a condition known as "smelly water" and can reduce the levels of bacteria that cause water-borne diseases.

Water Contamination Risk

Do not use chemicals that could contaminate the potable water supply. Do not use piping that has been treated with chromates, boiler seal, or other chemicals.



Fire Risk

To reduce the risk of a fire that could destroy your home and

seriously injure or kill people:

- Do not store things that can burn easily such as paper or clothes next to the water heater.
- Be sure the junction box cover and the element access door covers are in place. These covers keep debris from entering and potentially being ignited, and help keep any internal fires from spreading.
- Keep the water heater from becoming wet. Immediately shut the water heater off and have it inspected by a qualified person if you find that the wiring, thermostat(s) or surrounding insulation have been exposed to water in any way (e.g., leaks from plumbing or leaks from the water heater itself can damage property and could cause a fire risk). If the water heater is subjected to flood conditions or the thermostat(s) have been submerged in water, the entire water heater must be replaced.
- Make electrical connections properly, according to the instructions on page 17. Use 10 gauge solid copper wire. Use a UL listed or CSA approved strain relief. Connect the ground wire to the green ground screw.



Explosion Risk

High temperatures and pressures in the water heater tank can cause an

explosion resulting in property damage, serious injury or death. A new Temperature and Pressure (T&P) Relief Valve is included with your water heater to reduce the risk of explosion by discharging hot water. Additional temperature and pressure protective equipment may be required by local codes.

A nationally recognized testing laboratory maintains periodic inspection of the valve production process and certifies that it meets the requirements for Relief Valves for Hot Water Supply Systems, ANSI Z21.22.

The T&P Relief Valve's relief pressure must not exceed the working pressure rating of the water heater as stated on the rating plate.

Maintain the T&P Relief Valve properly. Follow the maintenance instructions provided by the manufacturer of the T&P Relief Valve (label attached to T&P Relief Valve). If no label is attached to the T&P Relief Valve, follow the instructions in the T&P Relief Valve Maintenance section of this manual.

An explosion could occur if the T&P Relief Valve or discharge pipe is blocked. Do not cap or plug the T&P Relief Valve or discharge pipe.

Fire and Explosion Risk if Hot Water is Not Used for Two Weeks or More

▲ CAUTION! Hydrogen gas builds up in a hot water system when it is not used for a long period (two weeks or more). Hydrogen gas is extremely flammable. If the hot water system has not been used for two weeks or more, open a hot water faucet for several minutes at the kitchen sink before using any electrical appliances connected to the hot water system. Do not smoke or have an open flame or other ignition source near the faucet while it is open.

GETTING STARTED

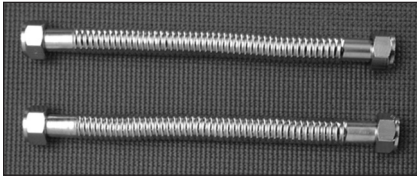

Figure 1 - Flexible connectors use compression fittings and do not require soldering.



Figure 2 - Use a non-contact circuit tester to insure that the power is off before you work on a circuit.



Figure 3 - Install a Pressure Reducing Valve if required.

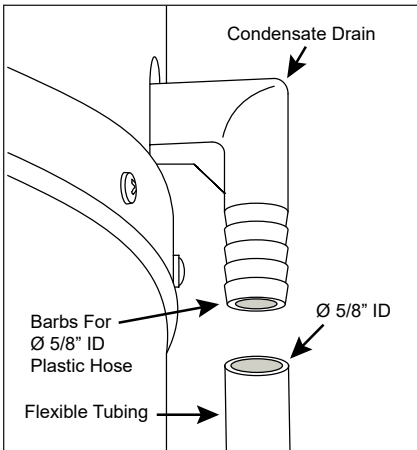

Figure 4 - Condensate drain connection

1 Review all of the instructions before you begin work. If you aren't sure that you can safely and properly do this work yourself, call a qualified person of your choice, such as a licensed plumber or electrician, to have the work done. Improper installation can damage the water heater, your home and other property, and can present risks of serious injury or death.

2 Check with your local and state authorities for any local or state codes that apply to your area. In the absence of local and state codes, follow National Fire Protection Association (NFPA-70) and the current editions of the National Electric Code (NEC) and the International Plumbing Code (IPC). The instructions in this manual comply with national codes, but the installer is responsible for complying with local codes.

Massachusetts code requires this water heater to be installed in accordance with Massachusetts 248-CMR 2.00 and 248-CMR 5.00: State Plumbing Code. Other local and state authorities may have similar requirements or other codes applicable to the installation of this water heater.

3 Before you start, be sure you have, and know how to use, the following tools and supplies:

- Plumbing tools and supplies appropriate for the type of water pipes in your home
- Threaded connections (Figure 1) for the cold and hot water pipes
- For homes plumbed with plastic pipe, use threaded connectors

suitable for the specific type of plastic pipe used: CPVC and PEX (cross-linked polyethylene). Do not use PVC pipe

- For homes with copper pipes, you may purchase connector kits with compression fittings that don't require soldering (Figure 1). Compression fittings are easier to install than soldering copper pipes
- Thread sealant tape or pipe joint compound approved for potable water
- Tools to make electrical connections (for example, screwdrivers and wire strippers)
- Non-Contact circuit tester to check for power (Figure 2)
- Water Pressure Gauge (Figure 5 on page 7)

Recommended Accessories:

- Suitable drain pan (Figure 7 on page 8)
- Shut-off device (kit available)
- Pressure Reducing Valve (Figure 3)
- Thermal Expansion Tank (Figure 6 on page 7)
- Point-of-use Thermostatic Mixing Valves (Figure 8 on page 8)

INSTALLATION

IMPORTANT: Follow these steps for proper installation.

Step 1:

✓ Verify that Your Home is Equipped and Up-to-Date for Proper Installation

Installing a new water heater is the perfect time to examine your home's plumbing system and make sure the system is up to current code standards. There have likely been plumbing code changes since the old water heater was installed. We recommend installing the following accessories and make any other changes to bring your home up to the latest code requirements.

Use this checklist and inspect your home. Install any devices you need to comply with codes and assure that your new water heater performs at its best. Check with your local plumbing official for more information.

✓ Water Pressure

We recommend checking your home's water pressure with a pressure gauge (Figure 5). Most codes allow a maximum incoming water pressure of 80 psi/551 kpa. We recommend a working pressure no higher than 50-60 psi/345-414 kpa.

HOW: Purchase an inexpensive water pressure gauge available at your local plumbing supplier. Connect the Water Pressure Gauge to an outside faucet and measure the maximum water pressure experienced throughout the day (highest water pressures often occur at night).

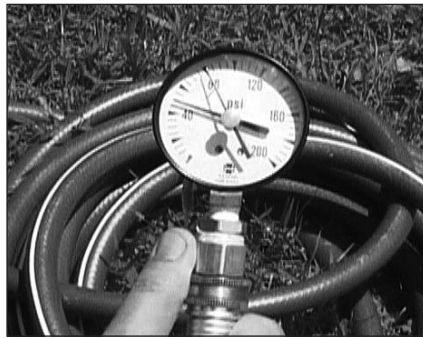

Figure 5 - Use a Water Pressure Gauge to make sure your home's water pressure is not too high.

To limit your home's water pressure: Locate your home's Pressure Reducing Valve (PRV) on the main incoming (cold) water supply line and adjust the water pressure control between 50 and 60 psi. If your home does not have a Pressure Reducing Valve, install a PRV on the home's main water supply line and set it to between 50 and 60 psi. Pressure Reducing Valves are available at your local plumbing supplier.

BACKGROUND: Over the years, many utilities have increased water supply pressures so they can serve more homes. In some homes today, pressures exceed 100 psi/689 kpa. High water pressures can damage water heaters, causing premature leaks. If you have replaced toilet valves, had a water heater leak, or had to repair appliances connected to the plumbing system, pay particular attention to your home's water pressure. When purchasing a PRV, make sure the PRV has a built-in bypass.

✓ Water Pressure Increase Caused by Thermal Expansion

Verify that you have a properly sized Thermal Expansion Tank (Figure 6). We recommend installing an expansion tank if your home does not have one. Codes require a properly pressurized, properly sized Thermal Expansion Tank in all homes that have backflow, check or pressure reducing valves (see illustration on inside front cover).



Figure 6 - A Thermal Expansion Tank helps protect the home's plumbing system from pressure spikes.

HOW: Connect the Thermal Expansion Tank (available at your local plumbing supplier) to the cold water supply line near the water heater. The expansion tank contains a bladder and an air charge. To work properly, the Thermal Expansion Tank must be sized according to the water heater's tank capacity and pressurized to match the home's incoming water pressure. Refer to the installation instructions provided with the Thermal Expansion Tank for installation details.

BACKGROUND: Water expands when heated, and the increased volume of water must have a place to go, or thermal expansion will cause large

INSTALLATION

increases in water pressure (despite the use of a Pressure Reducing Valve on the home's main water supply line). The Safe Drinking Act of 1974 requires the use of backflow preventers and check valves to restrict water from your home reentering the public water system. Backflow preventers are often installed in water meters and may not be readily visible. As a result, most all plumbing systems today are now "closed," and almost all homes now need a Thermal Expansion Tank.

A Thermal Expansion Tank is a practical and inexpensive way to help avoid damage to the water heater, washing machine, dishwasher, ice maker and even toilet valves. If your toilet occasionally runs for no apparent reason (usually briefly at night), that may be due to thermal expansion increasing the water pressure temporarily.

✓ Water Pipe and Tank Leaks

Leaks from plumbing pipes or from the water heater itself can damage property and could cause a fire risk.

- Install the provided leak detection sensor (see "Step 15" on page 18). An automatic cold water shut-off valve is also available for purchase (kit p/n 100345338). If an automatic cold water shut-off valve has been purchased, see "Step 9" on page 13 for installation instructions. These devices can detect water leaks and can shut off the water heater's water supply if a leak occurs.

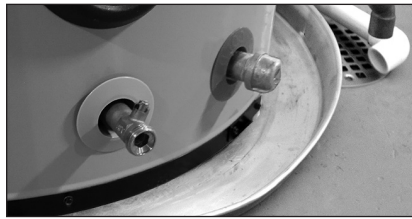

Figure 7 - A suitable drain pan piped to an adequate drain can help protect flooring from leaks and drips.

- Install a suitable drain pan (available at your local plumbing supplier) under the water heater (Figure 7) to catch condensation or leaks in the piping connections or tank. Most codes require, and we recommend, installing the water heater in a drain pan that is piped to an adequate drain. The drain pan must be at least 2" (50 mm) wider than the diameter of the water heater. Install the drain pan so the water level would be limited to a maximum depth of 1-3/4" (45 mm).

✓ Water Temperature Regulation



Figure 8 - Thermostatic Mixing Valves installed at each point-of-use can help prevent scalds.

Install Thermostatic Mixing Valves (Figure 8) to regulate the temperature of the water supplied to each point-of-use (for example, the kitchen sink, bathroom sink, bath and shower). Consult the valve manufacturer's instructions or a qualified person.

▲ WARNING! Even if the water heater thermostat is set to a relatively low temperature, hot water can scald. Install Thermostatic Mixing Valves at each point-of-use to reduce the risk of scalding (see page 4).

BACKGROUND: A Thermostatic Mixing Valve, installed at each point-of-use, mixes hot water from the water heater with cold water to more precisely regulate the temperature of hot water supplied to fixtures. If you are not sure if your plumbing system is equipped with properly installed and adjusted Thermostatic Mixing Valves, at each point of use where hot water is used, contact a qualified person for more information.

Step 2:

Verify that the Location is Appropriate

Before installing your water heater, ensure that:

- 1 The water heater will be:
 - Installed indoors close to the center of the plumbing system.
 - In a suitable drain pan piped to an adequate floor drain or external to the building (Figure 7).
 - In an area that will not freeze.
 - In an area that is suitable for installing the water heater vertically and on a level surface.
 - Installed where a typical home appliance sound would not cause a disturbance.
 - Not used for space heating.

NOTICE: Water heater must be level!

INSTALLATION

2 The location has adequate space (clearances) for periodic servicing. For optimal water heater efficiency, the unit must have unrestricted airflow and requires a minimum installation space of 700 ft³/19.8 m³. As an example, a room that has an 8 ft/2.4 m tall ceiling and is 10 ft/3 m long by 8-3/4 ft/2.6 m wide would contain 700 ft³/19.8 m³.

NOTICE: This Heat Pump Water Heater may be located within a required minimum of 6"/152 mm clearance from the front side and 12"/305 mm clearance from the top of the water heater. However, for future service considerations, a minimum of 3 ft/.9 m from any obstruction on the front side is recommended.

3 The floor can support the weight of a full water heater.

Capacity	Filled Weight (lbs.)
50 Gallon	573
66 Gallon	796
80 Gallon	921

4 Your area is not prone to earthquakes. If it is, use special straps as required by local building codes.

NOTICE: The state of California requires bracing, anchoring or strapping the water heater to avoid its moving during an earthquake. To contact local utilities for code requirements in your area, visit <http://www.dsa.dgs.ca.gov>, or call 1-916-445-8100 and request instructions. Other locations may have similar requirements. Check with your local and state authorities.

5 The location is not prone to physical damage by vehicles, flooding, or other risks.

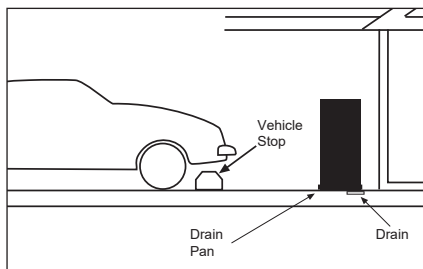

Figure 9 - In a garage, install a vehicle stop to avoid water heater damage.

6 Avoid locations such as attics, upper floors, or where a leak might damage the structure or furnishings. Due to the normal corrosive action of water, the tank will eventually leak. To minimize property damage from leaks, inspect and maintain your water heater in accordance with this manual's instructions. Inspect the drain pan, pipes, and surrounding area regularly and fix any leaks found. Drain pans are available at your local plumbing supplier. Leaks are frequently in the plumbing system itself and not the water heater.

7 The unit cannot be placed into any type of closet or small enclosure (less than 700 ft³), unless adequate provisions are made for air exchange (vented or louvered doors, ducting, etc.). Louvers shall be a minimum size of 24 inches by 14 inches, or provide the equivalent area of airflow.

For small enclosures with a minimum installation space of 300 ft³ to 699 ft³ (8.5 m³ to 19.7 m³), one louver shall be installed level with the water heater's top shroud.

For small enclosures with a minimum installation space of 120 ft³ to 299 ft³ (3.4 m³ to 8.4 m³), one louver shall be installed level with the water heater's top shroud and a second louver shall be installed directly above the first louver.

8 To ensure optimal performance and serviceability, a minimum clearance of 6"/152 mm must be maintained from the front side and 12"/305 mm from the top for access and serviceability.

9 Water heaters located in unconditioned spaces (i.e., garages, basements, etc.) may require the water piping, condensate piping, and drain piping to be insulated to guard from freezing.

10 The air filter, condensation drain and controls must be easily accessible for operation and service.

11 The site location must be free from any corrosive elements in the atmosphere such as sulfur, fluorine, sodium and chlorine. These elements are found in aerosol sprays, detergents, bleaches, air fresheners, paint and varnish removers, refrigerants and many other household products. In addition, excessive dust and lint may affect the operation of the unit (see "Air Filter Maintenance" on page 36).

12 The ambient air temperature must also be considered when installing this unit. In Heat Pump Mode, the air temperature needs to be above 37°F/3°C and below 120°F/49°C for heat pump operation. If the air temperature falls outside these upper and lower limits, the electrical elements will activate to meet the hot water demand. In this scenario, the heat pump will not operate in either Heat Pump Mode or Hybrid Mode.

INSTALLATION

Step 3:

Removing the Old Water Heater

1 Read each installation step and decide if you have the necessary skills to install the water heater. Only proceed if you can safely perform the work. If you are not comfortable, have a qualified person perform the installation.

2 Locate the water heater's circuit breaker and turn it OFF (or remove the circuit's fuses).

3 On the old water heater, remove the electrical junction box access panel. Using a non-contact circuit tester, check the wiring to make certain the power is OFF.

▲ WARNING! Working on an energized circuit can result in severe injury or death from electrical shock.

4 Disconnect the electrical wires.

5 Open a hot water faucet and let the hot water run until it is cool (this may take 10 minutes or longer).



Figure 10 - Let the hot water run until it is cool.

▲ WARNING! Be sure the water runs cool before draining the tank to reduce the risk of scalding.

6 Connect the garden hose to the drain valve and place the other end of the hose in a drain, outside, or a bucket. (Note that sediment in the bottom of the tank may clog the valve and prevent it from draining. If you cannot get the tank to drain, contact a qualified person.)

7 Turn the cold water supply valve OFF.

8 Open the drain valve on the water heater.



Figure 11 - Draining the old water heater.

9 Also open a hot water faucet to help the water in the tank drain faster.

10 When the tank is empty, disconnect the Temperature & Pressure (T&P) Relief Valve discharge pipe. You may be able to reuse the discharge pipe, but do not reuse the old T&P Relief Valve. A new T&P Relief Valve comes installed on your water heater (or on some models, is in the carton with the water heater).

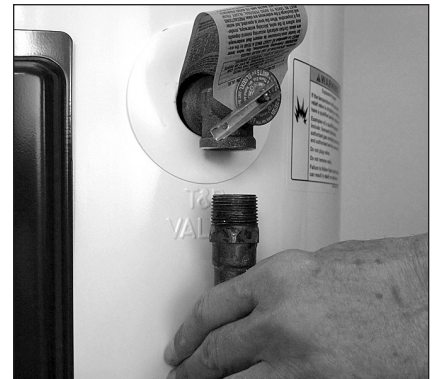

Figure 12 - Removing the T&P Relief Valve discharge pipe.

11 Disconnect the water pipes. Many water pipes are connected by a threaded union which can be disconnected with wrenches. If you must cut the water pipes, cut the pipes close to the water heater's inlet and outlet connections, leaving the water pipes as long as possible. If necessary, you can make them shorter later when you install the new water heater.

12 Remove the old water heater.

▲ WARNING! Use two or more people to remove or install the water heater. Failure to do so can result in back or other injury.

INSTALLATION

Step 4:

Installing the New Water Heater

1 Completely read all instructions before beginning. If you are not sure you can complete the installation, seek assistance from any of the following sources:

- Schedule an appointment with a qualified person to install your water heater.
- Call our Technical Assistance Hotline which is listed on the water heater's warranty sheet.

2 Install a suitable drain pan (if required) that is piped to an adequate drain.

3 Set the water heater in place taking care not to damage the drain pan.

NOTICE: Most codes require setting the water heater in a suitable drain pan piped to an adequate drain. The drain pan helps avoid property damage which may occur from condensation or leaks in the piping connections or tank. The drain pan must be at least 2" (50 mm) wider than the diameter of the water heater. Install the drain pan so the water level is limited to a maximum depth of 1-3/4" (45 mm).

4 Verify that the water heater is set in place properly. Check that:

- The T&P Relief Valve will not be in contact with any electrical parts.
- There is adequate space to install the T&P Relief Valve discharge pipe and that it can be piped to a separate drain (and not into the drain pan).

- There is adequate space to install proper condensate drain tubing.
- There is adequate access and space around the water heater for future maintenance. A minimum clearance of 6"/152 mm must be maintained from the front side of the water heater.
- Unit is level to allow proper condensate drainage. An unlevel unit may lead to condensate draining improperly, resulting in property damage.

DO NOT CONNECT ELECTRICAL WIRING UNTIL YOU ARE INSTRUCTED TO DO SO

NOTICE: Connecting electrical power to the tank before it is completely full of water (the water must run FULL STREAM from a hot water tap for a full three minutes) may cause the upper heating element to burn out.

Step 5:

Connecting the Condensate Pump When Required

NOTICE: If no floor drain is available, or the drain is above the level of the condensate line, a condensate pump must be installed.

Follow condensate drain pump manufacturer's instructions for installation.

Step 6:

Connecting the Condensate Pump Optional Overflow Shut-Off Switch

1 Locate the wiring loop next to the condensate drain connection (Figure 13). Cut the loop and strip insulation off the two ends (Figure 14).

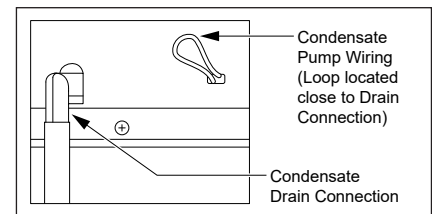

Figure 13 - Condensate Pump wiring.

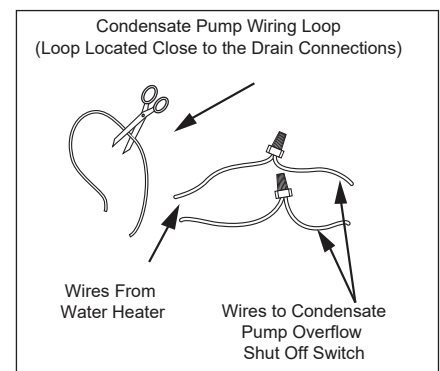

Figure 14 - Wiring Loop for connection to Condensate Pump.

- 2** Measure the distance from the wiring loop to the condensate pump. Cut two 22 AWG wires to correct length and strip the insulation at both ends.
- 3** Connect the two wires to the two wires on the water heater using wire nuts or other connectors.

INSTALLATION

- 4 Connect the free ends of the two wires to the shut-off switch on the condensate pump in accordance with the condensate pump manufacturer's recommendations.

Step 7:

Install Condensate Drain Line:

NOTICE: Barbed drain and flexible tubing for condensate drain line come pre-installed from the factory.

- Flexible tubing must be used to connect the condensate drain to a suitable drain or condensate pump.
- Condensate drain line should be installed in conditioned areas only. Install approved insulation on the condensate drain line to prevent condensation from forming on the outside of the drain line. Condensation drain lines installed in areas that are subject to freezing temperatures should be wrapped with a nationally recognized heat tape. Install per manufacturer's instructions.
- Do not connect condensate drain line with other drain or discharge lines into a single (common) pipe or line. Each line (condensate drain line, temperature and pressure relief valve discharge pipe, etc.) should be independently run to an adequate drain.
- Slope the condensate drain line toward the inside floor drain or condensate pump.
- The condensate drain line and connections to the drain piping must comply with all local codes.

- If a condensate pump is installed, it should be wired to shut off the heat pump in the event the condensate pump fails or the float switch in the pump activates (see "Connecting the Condensate Pump Optional Overflow Shut-Off Switch" on page 11).
- Allow enough length on the 5/8" ID flexible plastic tubing (pre-installed from the factory) to access an adequate drain.

Step 8:

Connect the Temperature and Pressure (T&P) Relief Valve/Pipe

Most T&P Relief Valves are pre-installed at the factory. In some cases, they are shipped in the carton and must be installed in the opening marked and provided for this purpose and according to local codes.

▲ WARNING! To avoid serious injury or death from explosion, install a T&P Relief Valve according to the following instructions:

If your water heater does not have a factory installed T&P Relief Valve, install the new T&P Relief Valve that came with your water heater. Do not reuse an old T&P Relief Valve. Install a T&P Relief Valve discharge pipe according to local codes and the following guidelines:

- 1 The discharge pipe should be at least 3/4" (19 mm) inside diameter and sloped for proper drainage. Install it to allow complete drainage of both the T&P Relief Valve and the discharge pipe.

- 2 The discharge pipe must withstand 250°F/121°C without distortion. Use only copper or CPVC pipe. Most homes use copper water pipes, but some use CPVC or cross-linked polyethylene (PEX). Use fittings appropriate for the type of pipe in your home. Do not use any other type of pipe, such as PVC, iron, flexible plastic pipe, or any type of hose.



Figure 15 - The T&P Relief Valve discharge pipe must be installed properly and piped to an adequate drain.

- 3 Terminate the discharge pipe a maximum of 6" (15 cm) above a floor drain, or outside the building. Do not drain the discharge pipe into the drain pan; instead pipe it separately to an adequate drain. In cold climates, terminate the discharge pipe inside the building to an adequate drain. Outside drains could freeze and obstruct the drain line. Protect the drain from freezing.
- 4 Do not place any valve or other restriction between the tank and T&P Relief Valve. Do not cap, block, plug, or insert any valve between the T&P Relief Valve and the end of the discharge pipe. Do not insert or install any reducer in the discharge pipe.

INSTALLATION

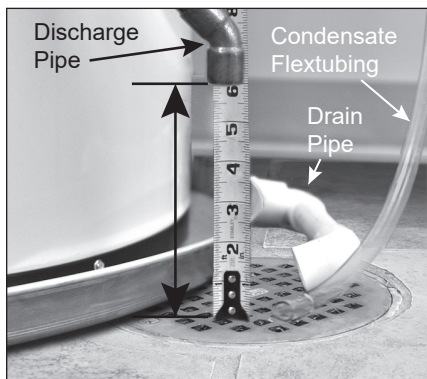

Figure 16 - The end of the T&P Relief Valve discharge pipe must stop no more than 6" (15 cm) above a floor drain or outside.

Step 9:

Install Shut-Off and Tempering Valves

1 Install a manual shut-off valve (available at your local plumbing supplier) on the cold water line that supplies the water heater. Install the shut-off valve near the water heater so that it is readily accessible. Only use valves that are compatible with potable water. Use only full-flow ball or gate valves. Other types of valves may cause excessive restriction to the water flow.

NOTICE: An automatic cold water shut-off valve is available for purchase (see the "Repair Parts" section of this manual). This is to be installed on the cold water line near the water heater. Make sure the module cable can be easily plugged into the Control Assembly (within 30"/76 cm). See included kit instructions found with the automatic cold water shut-off valve for further installation instructions.

2 Install Thermostatic Mixing Valves at each point-of-use (for example, the kitchen sink, bathroom sink, bath or shower). Consult the valve manufacturer's instructions or a qualified person.



Figure 17 - Install Thermostatic Mixing Valves at each point where hot water will be used.

▲ WARNING! Even if the water heater's thermostat(s) are set to a relatively low temperature, hot water can scald. Install Thermostatic Mixing Valves at each point-of-use to reduce the risk of scalding (see page 4).

3 For water heaters that are fed by a solar water heating system (or any other pre-heating system), always install a Thermostatic Mixing Valve or other temperature limiting device in the inlet water supply line to limit water supply inlet temperature to 120°F/49°C. Solar water heating systems can supply water with temperatures exceeding 170°F/77°C and may result in water heater malfunction.

▲ WARNING! Hot water provided by solar heating systems can cause severe burns instantly, resulting in severe injury or death (see page 4).

Step 10:

Connect the Water Supply

1 Determine the type of water pipes in your home. Most homes use CPVC or cross-linked polyethylene (PEX). Use fittings appropriate for the type of pipe in

your home. Do not use iron or PVC pipe – they are not suitable for potable water.

2 The water heater can be plumbed to either the top or side connections, however, only one option shall be chosen (neither top nor side connections may be used in combination). The unused connections must be capped with the caps provided.

3 Connect the cold water supply using 3/4 inch National Pipe Thread "NPT" to the BLUE cold water connection on either the top or side of the water heater.

For ease of removing the water heater for service or replacement, connect the water pipes with a coupling called a union. We recommend using a dielectric-type union (available at your local plumbing supplier). Dielectric unions can help prevent corrosion caused by tiny electric currents common in copper water pipes and can help extend the life of the water heater.

NOTICE: This water heater model contains an **optional** side outlet connection (J-tube) that has an orientation mark that must line up with arrow (in a 12 o'clock position).

4 Connect the hot water supply using 3/4 inch NPT to the corresponding RED hot water connection on either the top or side of the water heater. Follow the same connection guidelines as for the cold water supply.

INSTALLATION

IF YOU HAVE COPPER PIPES:

If your home has copper water pipes, you can solder the water pipe connections or use compression fittings which do not require soldering. Compression fittings are easier to install than soldering pipe. Check with local plumbing officials to determine what types of pipe materials are suitable for your location. Do not use lead-based solder.

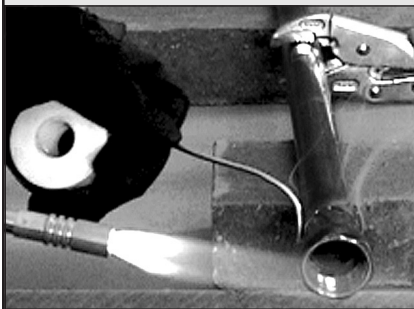

NOTICE: Do not solder pipes while they are attached to the water heater. The water heater's inlet and outlet connections contain non-metallic parts which could be damaged. The proper way to connect the water heater to copper water pipes is as follows:

Solder a short length of pipe (about a foot or so) to a threaded adapter using only 95/5 tin-antimony or equivalent solder. Attach the threaded adapters to the water heater's connections (using thread sealant tape or pipe joint compound). Connect the home's water pipes by soldering, keeping the connections at the water heater cool with wet rags.

NOTICE: Do not over apply joint compound.

5 Install insulation (or heat tape) on the water pipes especially if the indoor installation area is subject to freezing temperatures. Insulating the hot water pipes can increase energy efficiency.

6 Double check to make sure the hot and cold water pipes are connected to the correct hot and cold water fittings on the water heater. Ensure unused hot and cold connections are plugged and capped.

7 If needed, install (or adjust) the home's Pressure Reducing Valve to 50-60 psi and install a Thermal Expansion Tank.



Figure 18 - A Pressure Reducing Valve is required if your home's water pressure is above 80 psi.



Figure 19 - The Thermal Expansion Tank should be pressurized with air to match the home's incoming water pressure.

Recirculating Loop

A recirculation loop is sometimes provided in a hot water system where it is desirable to have on demand hot water at the fixtures.

A smaller diameter size pipe with an inline circulation pump is plumbed to a location near the furthest fixture and to a location near the water heater. The pump can run continuously or intermittently circulating enough tempered water to keep heat loss in the plumbing system, during low or no demand, within an acceptable limit.

A recirculation loop in your home provides on demand hot water to your fixtures quickly and helps mitigate the amount of wastewater sent down the drain while you wait, but hot water may be continuously flowing through your plumbing system. If your recirculation pipes are not insulated well enough to prevent heat energy loss, then your pipes will radiate heat throughout the surrounding areas of your home. The heat energy lost can cause your heat pump water heater to work continuously to maintain the heat in the pipes.

This heat pump water heater is programmed with proprietary software to ensure the water heater operates at peak efficiency. Demand for hot water in the plumbing system will draw hot water from the tank causing a heating cycle as the supply water temperature is much cooler than the water in the tank. You should consider alternatives to installing a heat pump water heater in conjunction with a residential recirculation loop to prevent the water heater from running continuously due to the lower input

INSTALLATION

of these types of units, potentially causing a “no hot water” condition.

We do not recommend this heat pump water heater for use in conjunction with recirculation loop systems due to the wide variety of applications and variability in installation and performance of these systems. We can provide the following guidance that you may use to determine if this heat pump water heater will operate at peak efficiency in your specific application.

If your recirculation loop or pump is designed to help provide on demand hot water to sinks, showers, etc., and does not present a significant continuous heating load, this heat pump water heater can generally be used with on demand recirculation systems or with those specifically programmed to operate only for short periods of the day when demand is expected.

Energy savings from this heat pump water heater could be significantly impacted depending on conditions associated with the specific application. The heat energy lost in a recirculation loop system can cause your water heater to run excessively. This heat pump water heater may not be able to accommodate demand.

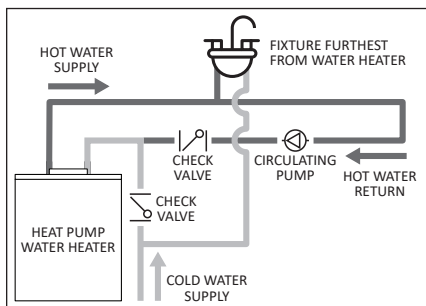

Figure 20 - Recirculation Loop Diagram

Step 11: Ducting Requirements (optional)

Heat is absorbed from air entering the intake side of the compressor unit on top of the water heater and transferred to the water inside the storage tank. Cooler dehumidified air exiting the exhaust side of the compressor unit is a normal by-product of operation. In unvented applications, a minimum installation space of 700 ft³/19.8 m³ is required, however, if adequate provisions are made for air exchange, this water heater may be installed in small enclosures with a minimum installation space of 120 ft³/3.4 m³ (see “Verify that the Location is Appropriate” section in this manual for more information about required ducting and vented or louvered doors). The factory installed duct adaptors can be used to redirect intake and/or exhaust air from or to other locations to permit installation in confined spaces, improve performance and maintain comfort in occupied areas of the home.

INSTALLATION LIMITATIONS

There are two duct adaptors; one connects to the air exhaust side of the top shroud (near the back of the water heater) and one to the air intake side of the top shroud (near the front of the water heater). The two cannot be interchanged. The inlet and outlet duct adaptors on the water heater accept 8” diameter ducting. No additional adaptors are needed.

7”, 6” and 5” diameter ducting is supported. The table below lists the total feet of ducting allowed. For duct

diameters smaller than 8” diameter, the table takes into account the duct reducer(s) and up to 10 feet of 8” inch rigid ducting (two elbows) before the duct reducer(s) at the unit. Duct reducers must be installed within 10 feet (two elbows) of the unit or within 2 feet of the end of the duct.

IMPORTANT: A minimum length of 12” flexible ducting (8” diameter) must be installed between the duct adaptors and any rigid ducting.

Air can be drawn from or expelled to the outdoors, an attic space, or to another room inside the home.

INSTALLATION CONSIDERATIONS

The compressor unit on the water heater is disabled when the temperature of the air flowing to the intake is lower than 37°F/3°C or higher than 120°F/49°C. These operational parameters must be considered when determining if a location to duct air from/to will be suitable.

NOTICE: If the compressor unit is disabled for long periods of time due to air intake temperature being too hot or too cold, the potential energy savings a heat pump water heater is able to provide may be significantly reduced.

AIR INTAKE

Outdoor air temperatures will often be lower than 37°F/3°C in many regions during fall and winter months. Attic temperatures will often exceed 120°F/49°C in many regions during spring and summer months. For units installed in conditioned spaces, ducting outdoor air to the intake of the unit may place additional load on space heating and cooling equipment

INSTALLATION

Duct Type / Diameter	8”	7”	6”	5”
Flexible	100’	50’	24’	—
Rigid	300’	155’	65’	20’

INSTALLATION

unless the air from the exhaust is also ducted to an alternate location.

Air being drawn from an alternate location inside the home may cause a negative pressure condition inside that area. As a result, cold or hot air from outdoors may be drawn into the structure and place additional load on the space heating and cooling equipment.

AIR EXHAUST

The air exhaust from a unit installed in a garage or any area where solvents or other chemicals that emit potentially harmful fumes are stored or automobiles are located must never be ducted to any other space inside the building structure. This would include all occupied and unoccupied spaces such as attics or basements. Potentially harmful fumes and vapors from solvents and cleaners or automobile exhaust gases could be introduced into living spaces. Cold air blowing from the air exhaust into an alternate location inside the home may cause cooling discomfort and be objectionable. Cold air blowing from the air exhaust into an alternate location inside the home may place additional load on space heating equipment during fall and winter months.

Ducting only exhaust air to an alternate location may cause a negative air pressure in the installed space. As a result, cold or hot air from outdoors may be drawn into the structure and place additional load on the space heating and cooling equipment.

Step 12:

Ducting Installation (optional)

- 1 Read each installation step and decide if you have the necessary skills to install intake and exhaust ducting to and from the heat pump water heater. Only proceed if you can safely perform the work. If you are not comfortable, have a qualified person perform the installation.
- 2 After the desired length of 8" flexible duct has been determined, carefully cut completely around and through the duct insulation jacket with a pair of scissors. Using a pair of wire cutters, cut the wire inside the core duct. Fold the duct insulation jacket back away from the core duct.
- 3 Slide the core duct over the air exhaust duct adaptor and secure with a cable tie. Seal core duct with at least two wraps of insulation tape over cable tie.
- 4 Slide duct insulation jacket back over the core duct and the air exhaust duct adaptor. Use insulation tape to secure the duct insulation jacket to the air exhaust duct adaptor. Additionally, secure duct insulation jacket with cable tie. Repeat procedure for the air intake duct adaptor.
- 5 Add support to the duct work as necessary with ducting tube hooks or as required by local codes. Special attention must be given to prevent large droops in the duct work which could allow moisture to pool.

- 6 The appropriate duct termination shall be added to the termination end of the duct. This termination shall prevent any debris or rodents from entering the duct work and shall minimally restrict airflow through the ducting. In addition, the termination shall be designed to prevent rain from entering the duct work if terminated to the outside.

- 7 The flow area termination must be at least 40 sq in. to avoid overloading the heat pump water heater fan.

Step 13:

Verify Connections and Completely Fill Tank

To remove air from the tank and allow the tank to fill completely with water, follow these steps:

- 1 Remove the aerator at the nearest hot water faucet. This allows any debris in the tank or plumbing system to be washed out.
- 2 Turn the cold water supply back on and ensure any shut-off valves installed on the cold water supply line are open.



Figure 21 - Fully open the cold water supply valve (full-flow ball valve pictured above).

INSTALLATION

- 3 Open a hot water faucet and allow the water to run until it flows with a full stream.
- 4 Let the water run full stream for three full minutes.
- 5 Close the hot water faucet and replace the aerator.
- 6 Check inlet and outlet connections and water pipes for leaks. Dry all pipes so that any drips or leaks will be apparent. Repair any leaks. Almost all leaks occur at connections and are not a tank leak.

Step 14:

Make Electrical Connections

▲ WARNING! Working on an energized circuit can result in severe injury or death from electrical shock.

NOTICE: Do not turn electrical power on unless you are sure all of the air is out of the tank and the tank is completely full of water. Although this water heater is equipped with “Dry-Fire” protection, be certain all air is purged from the tank before making any electrical connections.

- 1 Be sure the electrical power to the water heater is turned OFF at the circuit breaker panel (or remove the circuit’s fuses).
- 2 Using a non-contact circuit tester, check the wiring to make certain the power is OFF and the circuit is not energized.
- 3 This water heater requires a 208/240 VAC single phase 30 amp power supply, at 50Hz or 60Hz. Check the water heater’s data plate (Figure 23) and ensure that the home’s voltage, wiring size (ampacity)

and circuit breaker rating and type are correct for this water heater. Refer to the wiring diagram located on the water heater, and on page 37 of this manual, for the correct electrical connections. Ensure that wire sizes, type, and connections comply with all applicable local codes. In the absence of local codes, follow NFPA-70 and the current edition of the National Electric Code (NEC).

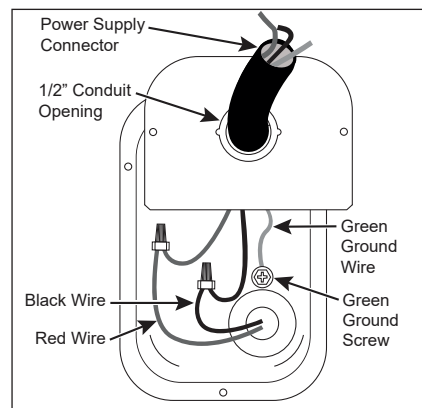

Figure 22 - Connecting the electrical wires (bottom cover to electrical junction box removed for clarity).

If metal conduit is used for the grounding conductor:

- The grounding electrode conductor shall be 10 gauge solid copper wire. The copper wire shall be of one continuous length without a splice or joint.
- Rigid metal conduit, intermediate metal conduit, or electrical metallic tubing may be used for the grounding means if conduit or tubing is terminated in fittings approved for grounding.
- Flexible metal conduit or flexible metallic tubing shall be permitted for grounding if all the following conditions are met:

- I. The length in any ground return path does not exceed 6 feet/1.8 m.

- II. The circuit conductors contained therein are protected by overcurrent devices rated at 30 amperes.
- III. The conduit or tubing is terminated in fittings approved for grounding.

For complete grounding details and all allowable exceptions, refer to the current edition of the National Electric Code NFPA-70.



Figure 23 - The water heater’s electrical requirements can be determined from the data plate.

- 4 Remove the top and bottom covers on the electrical junction box on the side of the water heater.
- 5 Install wiring in an approved conduit (if required by local codes). Use a UL listed or CSA approved strain relief to secure the electrical wiring to the water heater.
- 6 Connect the ground wire to the green ground screw. Connect the home’s two power wires to the water heater’s two power wires. Use suitable wire nuts or other approved means to make the power connections.
- 7 Replace the junction box covers and secure with the screws provided.

▲ WARNING! Be sure cover is secured to reduce the risk of fire and electric shock.

INSTALLATION

Step 15:

Installing the Leak Detection Sensor

The Leak Detection Sensor (LDS) does not provide protection against a water leak, it only provides notification that water is present in the location of the sensor. When a leak is detected, the Control Assembly will display an error code accompanied by a flashing light and audible signal. If the presence of water is indicated, disconnect power to the water heater, turn off the incoming water and address the source of the leak before returning the unit to service. See included kit instructions found with the LDS for detailed installation instructions.

- 1 Plug the LDS into the connection port next to the lower element access panel.
- 2 Attach the LDS to the heater or drain pan using the tape on the back of the LDS. Ensure the metal probes point down.
- 3 Use the included wire clamps to organize the wires.

Step 16:

Adjusting the Temperature

With the installation steps completed, you may adjust the water heater's temperature setting if desired.

- 1 Turn the electric power back on. Remove/pull out the battery protective tab from the left side of the Control Assembly.
- 2 Set the thermostat to the desired temperature on the Control Assembly (see

"Adjusting the Control Assembly's Operational Modes" on page 21). The set point on this water heater has been factory set to approximately 120°F/49°C to reduce the risk of scald injury. You may wish to set a higher temperature to provide hot water for automatic dishwashers or laundry machines, to provide more hot water capacity, and to reduce bacterial growth. Higher tank temperatures (140°F/60°C) kill bacteria that cause a condition known as "smelly water" and can reduce the levels of bacteria that cause water-borne diseases.

▲ WARNING! Higher temperatures increase the risk of scalding, but even at 120°F/49°C, hot water can scald (see page 4).

If you increase the water heater's temperature setting, install Thermostatic Mixing Valve(s) at each point-of-use to reduce the risk of scalding.



Figure 24 - Adjust Thermostatic Mixing Valves at each point-of-use to 120°F/49°C or lower.

- 3 Wait for the water to heat up. It may take several hours for a tank of cold water to heat up. If you have no hot water after two hours, refer to the "Troubleshooting" section (beginning on page 25).

▲ WARNING! If you have increased the temperature setting and the Thermostatic Mixing Valves are not set properly (or not installed) you could scald yourself while checking the temperature.

- 4 Check water temperature at several points in your home (for example, the bathtub faucet, shower, or lavatory sink) and adjust the Thermostatic Mixing Valves as needed. If you are not sure how to adjust the Thermostatic Mixing Valve settings, or are not sure if you have Thermostatic Mixing Valves, contact a qualified person.

Post Installation Review

- 1 Understand how to use the Control Assembly to set the various modes and functions.
- 2 Hybrid Mode is the recommended Operating Mode. Understand the various Operating Modes and which mode may be best, based on ambient temperature and hot water demands.
- 3 Understand the importance of routine inspection/maintenance of the condensate drain pan and line. This is to prevent any possible drain line blockage resulting in the condensate drain pan overflowing.
- 4 To maintain optimal operation, check, remove and clean the air filter as needed.
- 5 The installation Instructions and Use and Care Guide should be kept with the water heater for reference.

OPERATION

Start-up and Operation

NOTICE: The default operating mode is Hybrid Mode. To select a different mode, see “Adjusting the Control Assembly’s Operational Modes” on page 21.

1 Turn the electric power on at the circuit breaker panel, or fuse box. Power to the water heater will allow the water heater to run a system diagnostic. This typically takes a several minutes.

NOTICE: The water heater will conduct a system diagnostic (approximately seven (7) to ten (10) minutes) each time power is applied from an off state. Normal operation will begin after the system diagnostic has been completed. If the system diagnostic yields any codes, reference the diagnostic codes section in this manual.

2 The diagnostic sequence typically takes seven (7) to ten (10) minutes. During this period the Control Assembly will display a series of single, alternating dashes repetitively. Once the diagnostic sequence has finished, the fan will turn on.

NOTICE: The heat pump’s fan will not turn on if the incoming water temperature is less than 55°F/13°C and/or the ambient air temperature is above 120°F/49°C, or below 37°F/7°C. Should the internal diagnostics detect the heat pump is out of operational range, the Control Assembly will display the code **HPO**.

3 Set the desired operational mode. For typical installations, the factory default mode (Hybrid Mode) offers the best combination of efficiency and hot water delivery.

Operating Mode Descriptions

The operating modes can be changed by pressing the button for any desired mode (Figure 25 on page 21). The Operation Mode Indication Light will turn on when the relevant mode is selected.

This unit is equipped with technology that senses the hot water demand from the unit. While in Heat Pump or Hybrid mode, during normal usage, the unit will operate the heat pump for maximum efficiency. In Hybrid mode, during periods when the water usage is above normal, this unit has the ability to use one element (upper or lower) and the heat pump simultaneously to help improve recovery. This transition is seamless and will go unnoticed.

General Operation

IMPORTANT: On the initial start-up of the unit, the water heater will go through a seven (7) to ten (10) minute diagnostic period prior to heating the water.

NOTICE: If the water is warm/hot, the unit will not go through the diagnostic period.

The primary function of the Control Assembly is to heat the water in the tank until it reaches the control set point. The water heater has three means of heating the water: the elements, the heat pump, and a combination of the elements and heat pump.

The control logic of the Control Assembly is designed so that the heat pump will always have priority over the elements. The temperature regulation will not be performed

until after Dry-Fire detection testing indicates that there is sufficient water in the tank.

Vacation Mode

To save energy, select Vacation mode to lower the temperature setting on the thermostat if you plan to be away for an extended time.

NOTICE: Vacation mode has a fixed set point of 50°F/10°C.

When Vacation mode is selected, the vacation timer will be displayed. The default vacation days are preset at 7 days. Press the Up and Down button to modify the timer to desired number of vacation days (setting range: 1 to 99 days or permanently ON). The vacation timer will blink on the display; press the Enter button to confirm the vacation timer. To deactivate Vacation mode, press the Vacation mode button to return to the previous operating mode or press the button for any other desired mode.

When the vacation days decrease to 9 hours remaining, the Control Assembly will automatically switch to the previously selected mode.

NOTICE: Normally, the display will only show the remaining vacation days.

▲ WARNING! Hydrogen gas builds up in a hot water system when it is not used for a long period (two weeks or more). Hydrogen gas is extremely flammable. If the hot water system has not been used for two weeks or more, open a hot water faucet for several minutes at the kitchen sink before using any electrical appliances connected to the hot water system. Do not smoke or have an open flame or other ignition source near the faucet while it is open.

OPERATION

Heat Pump Mode

Provides the highest efficiency and lowest cost operation by using only the heat pump for heating. Recovery time and efficiency will vary with ambient temperature and relative humidity. Efficiency will be greatest, and recovery quickest, when both are high. At lower temperatures and relative humidity levels, efficiency will be lower and recovery will take longer. Heat pump operation is allowed between 37°F/3°C to 120°F/48.9°C ambient temperature. At ambient temperatures lower than 37°F/3°C and greater than 120°F/48.9°C, the heat pump will not operate. Similarly, if the water temperature in the tank is less than 55°F/13°C, the heat pump will not operate. The Control Assembly will display the code **HPO**, and the unit will operate in Electric mode until ambient air and water temperatures return to the safe operating range of the heat pump.

Hybrid Mode

This is the default, recommended setting combining high energy efficiency with reduced recovery time. This mode uses the heat pump as the primary heating source. One of the heating elements (upper or lower) will provide supplementary heating if demand exceeds a predetermined level so that the set point temperature can be recovered more quickly.

Electric Mode

The water heater functions as a conventional electric unit, relying on only the elements for heat. This mode may be useful in periods of increased hot water demands. When Electric Mode is selected, the duration timer will be displayed. The default Electric Mode days are preset at 3 days. Press the Up and Down button to modify the timer to the desired number of Electric Mode days (setting range: 1 to 7 days). The timer will blink on the display; press the Mode/Enter button to confirm the Electric Mode timer.

NOTICE: Do not shut off power to the unit for extended periods of time. If power must be turned off for an extended period of time, turn OFF the power to the water heater at the circuit breaker/fuse box, and then drain the tank completely.

Other Controls

°F/°C SWITCH:

Press and hold the “Temperature Down” button, in combination with the “Enter” button, for 3 seconds to switch temperature unit between Fahrenheit and Celsius.

HEAT PUMP DEFROSTING INDICATION:

There will be frost accumulating on the evaporator when the heat pump is operated under low ambient temperatures. The controller will order the unit to enter defrosting cycle to optimize the heat pump operation performance. During the defrosting period, the user interface module will display **ICE** as an indication.

OUT OF HEAT PUMP OPERATION RANGE:

The Control Assembly will display **HPO** as an indication that the ambient and/or water temperature condition is out of the heat pump operation range.

NOTICE: The display will go into “Sleep Mode” for energy saving if there is no operation on any button for 15 minutes. All of the display and lights will be turned off except for the “Operational Mode Indication Light,” which will remain illuminated while the unit is powered on. The unit can be awakened by pressing any button.

Your Heat Pump Water Heater is equipped with an EcoPort CTA-2045 communication port. Contact your local electric utilities company for participation and plug in module availability and to learn more about potential energy savings opportunities.

OPERATION

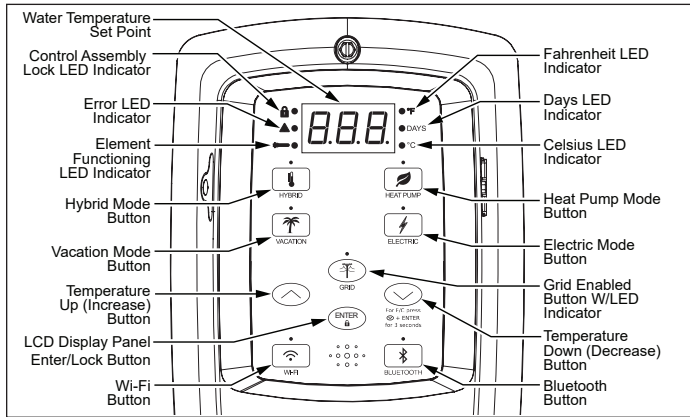

Figure 25 - Control Assembly

ADJUSTING THE CONTROL ASSEMBLY'S OPERATIONAL MODES

If locked, the operating modes can be changed by holding the **ENTER** button for approximately 3 seconds, then touching the desired mode icon on the Control Assembly (Figure 25).

WATER TEMPERATURE ADJUSTMENT

IMPORTANT: On the initial start-up of the unit, the water heater will go through a seven (7) to ten (10) minute diagnostic period prior to heating the water. Before attempting to adjust the thermostat, read the "Important Safety Information" section on page 4. If the instructions are not clear, contact a qualified service technician.

The water temperature can be adjusted from 95°F/35°C to 150°F/65°C by pressing **Temperature Up (Increase) Button** followed by the **ENTER** button to set the desired temperature. The Control Assembly is unlocked by default. To lock the display after setting the parameters, hold the **ENTER** button for 3 seconds.

	HYBRID MODE - System default mode. Pressing this button will allow high efficiency heat pump operation with supplementary heating from a backup heating element during periods of high demand.
	HEAT PUMP MODE - Provides the highest efficiency and lowest cost operation by using only the heat pump for heating while in safe operating range of the heat pump.
	VACATION MODE - The controller adjusts the set point to approximately 50°F/10°C. This mode is recommended when the water heater is not in use for a long period of time. This mode minimizes energy consumption and prevents the water heater from freezing during cold weather.
	ELECTRIC MODE - The water heater functions as a conventional electric unit, relying on only the elements for heat. This mode may be useful in periods of increased hot water demand.
	SMART GRID CONTROL - Pressing this button will enable or disable a request for grid control (see page 24).
	CONTROL ASSEMBLY LOCK - Holding this button for more than 3 seconds switches the lock mode on or off.
	Wi-Fi - Press this button once to activate the Wi-Fi signal.
	BLUETOOTH - Press this button once to activate the Bluetooth signal.
°F/°C	°F/°C - Press and hold the "Temperature Down" button, in combination with the "Enter" button, for 3 seconds to switch temperature unit between Fahrenheit and Celsius.
	HEATING CYCLE ICON - Indicates the water heater is in a heating cycle and the elements are energized.
DAYS	DAYS - Indicates the number of days (1 to 99+) the unit will be set in vacation mode.
	CAUTION INDICATOR - Indicates when there is a Warning/Fault.
102	FAULT CONDITION - Will display a three digit fault code with Alert Icon Flashing (see Diagnostic code chart on page 25).
	LOCK - Indicates the control assembly is locked.

OPERATION

OPERATION

Wi-Fi (Control Assembly)

This water heater comes equipped with the iCOMM™ remote monitoring system. It allows users to monitor critical operations and diagnose issues remotely using the manufacturer's water heater app (available for IOS and Android).

The iCOMM system can automatically notify selected personnel via email and/or cellular phone text messages if operational problems occur.

It is recommended the water heater app be installed on the homeowner's device prior to setting up the Wi-Fi function on this water heater.

IMPORTANT: By enabling and connecting your water heater to Wi-Fi, you are granting permission to the manufacturer to push "over-the-air" (OTA) updates to the water heater and to collect telemetry data regarding the water heater. The OTA updates may be pushed periodically to address bugs and provide security patches. Refer to the Terms and Conditions at www.aosmith.com/Utility-Pages/Terms-and-Conditions/ for more details. Also, refer to www.aosmith.com/Privacy-Policy/ for more information about how we collect and use data.

Wi-Fi Set Up:

The Wi-Fi signal is set to OFF by default and will not produce a signal until activated.

NOTICE: Have the router SSID and password ready.

- Download the iCOMM Utilities app for your smart phone.



- Launch the iCOMM Utilities app on your smart phone, then follow the

simple steps. The iCOMM Utilities app makes it easy to set up, program and control your water heater.

- Create an account or log in to your existing account and tap the "add a water heater" button.
- When the app prompts you to activate the Wi-Fi signal, proceed with the following steps:

- 1 To activate the Wi-Fi signal, press the Wi-Fi button once. The LED will blink on and off in 1/2 second intervals. Wi-Fi will activate pairing mode (Figure 26).

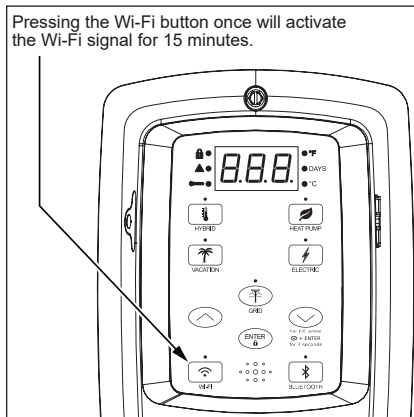

Figure 26 - Wi-Fi Control

- 2 The app will display a temporary Wi-Fi network to connect to your device.

Select the network that matches the water heater DSN value, and your device will connect to the Wi-fi radio on the Control Assembly:

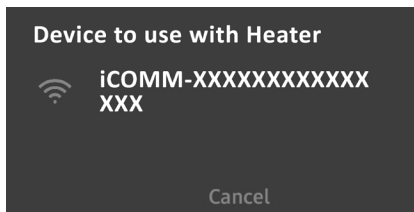

Figure 27 - Select Temporary Network

- 3 The app will begin the communication process of linking your water heater to your Wi-Fi router.

- 4 Select your preferred Wi-Fi network from the list on the app. LED will pulse from dim to bright when attempting to connect to local network.

Choose Your Wi-Fi Network

Select your Wi-Fi network from the list below. If you don't see it, refresh the list.

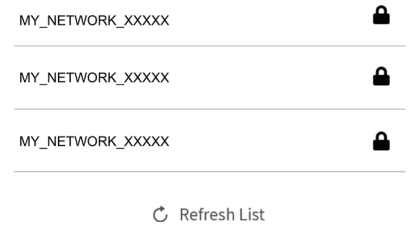

Figure 28 - Select Your Wi-Fi Network

NOTICE: If the app does not prompt you with a list of available Wi-Fi networks, access Wi-Fi settings on your device and select your preferred network.

- 5 The app will attempt to connect with your Wi-Fi network. We recommend connecting to a Wi-Fi network that has been secured with a password. The LED will hold solid when connected.
- 6 The app will display the water heater temperature set point.
- 7 Configure the water heater Set Point, Mode, and Time of Use Rate Plan if applicable.

NOTICE: If the Wi-Fi signal is to be terminated, press and hold the Wi-Fi button for 3 seconds. This will turn the Wi-Fi signal off. The Control Assembly will beep once. The Control Assembly resets and the LED display will turn off. The original connected network has been removed from the memory of the water heater Control Assembly.

OPERATION

Bluetooth (Control Assembly)

This water heater comes equipped with the iCOMM™ remote monitoring system. It allows users to monitor critical operations and diagnose issues remotely using the manufacturer’s water heater app (available for IOS and Android).

The iCOMM system can automatically notify selected personnel via email and/or cellular phone text messages if operational problems occur.

It is recommended the water heater app be installed on the homeowner’s device prior to setting up the Bluetooth function on this water heater.

IMPORTANT: By enabling and connecting your water heater to Bluetooth, you are granting permission to the manufacturer to push “over-the-air” (OTA) updates to the water heater and to collect telemetry data regarding the water heater. The OTA updates may be pushed periodically to address bugs and provide security patches. Refer to the Terms and Conditions at www.aosmith.com/Utility-Pages/Terms-and-Conditions/ for more details. Also, refer to www.aosmith.com/Privacy-Policy/ for more information about how we collect and use data.

Bluetooth Set Up:

The Bluetooth signal is set to OFF by default and will not produce a signal until activated.

NOTICE: Have the device SSID and password ready.

- Download the iCOMM Utilities app for your smart phone.



- Launch the iCOMM Utilities app on your smart phone, then follow the simple steps. The iCOMM Utilities app makes it easy to set up, program and control your water heater.
- Create an account or log in to your existing account and tap the “add a water heater” button.
- When the app prompts you to activate the Bluetooth signal, proceed with the following steps:

- 1 To activate the Bluetooth signal, press the Bluetooth button once. The LED will blink on and off in 1/2 second intervals. Bluetooth will activate pairing mode (Figure 29).

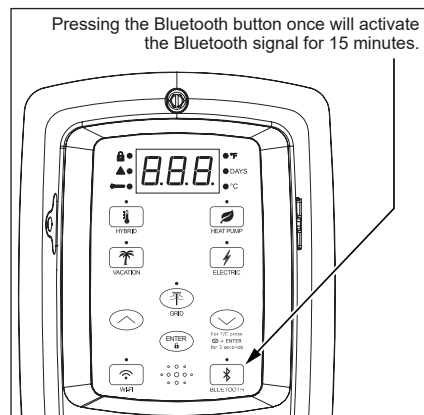

Figure 29 - Bluetooth Control

- 2 Select the option in the app to begin linking your device with the Bluetooth radio on the Control Assembly.
- 3 The app will begin the communication process of linking your water heater to your Bluetooth device.
- 4 The app will attempt to connect with your Bluetooth device. We recommend connecting to a Bluetooth device that has been secured with a password. The LED will hold solid when connected.
- 5 The app will display the water heater temperature set point.
- 6 Configure the water heater Set Point, Mode, and Time of Use Rate Plan if applicable.

NOTICE: If the Bluetooth signal is to be terminated, press and hold the Bluetooth button for 3 seconds. This will turn the Bluetooth signal off. The Control Assembly will beep once. The Control Assembly resets and the LED display will turn off. The original connected device has been removed from the memory of the water heater Control Assembly.

OPERATION

Smart Grid Technology

The electric Smart Grid will enable significant improvements in electric power reliability and quality through reduction of peak power demand, while providing consumers the knowledge and ability to manage their energy consumption and utility costs. According to the Department of Energy (DOE), since 1982 the growth in peak electricity demand has exceeded power transmission growth. This has caused more frequent blackouts and service interruptions, as well as an increase in the costly reserve capacity the power grid requires to meet higher peak demands. The increased demand for electrical power across the nation has also led to higher peak utility costs.

Smart appliances are one way to help mitigate this problem. By using advanced digital communication technologies, smart appliances will be able to communicate with local power companies or home energy systems, and react accordingly to save energy and money. For example, during peak demand periods, the water heater may pause or delay its power consumption and thus reduce the load on the smart utility grid. Additionally, smart appliances will also communicate with consumers to let them know how much energy they are consuming. This will eventually allow consumers to control their appliances, manage energy usage, and ultimately save money.

EcoPort CTA-2045, Smart Grid Control (Where Available)

Where available, grid communication adaptors called Universal Communication Modules (UCM) may be supplied by the local power company or purchased from leading retailers. A UCM is a direct digital thermostat that provides integrated control of the unit's thermostat. Please contact your local power company for more information.

▲ WARNING! Electrical Shock Hazard. Disconnect power before servicing. Replace all parts and panels before operating. Failure to do so can result in death or electrical shock.

To activate Smart Grid Control, turn off electric power to the water heater at the circuit breaker or fuse box. Using a non-contact circuit tester, check the power wires to make certain the power is OFF. Remove the cover over the grid connection pins and plug in the UCM grid communication adaptor and return power to the water heater at the circuit breaker or fuse box (Figure 30).

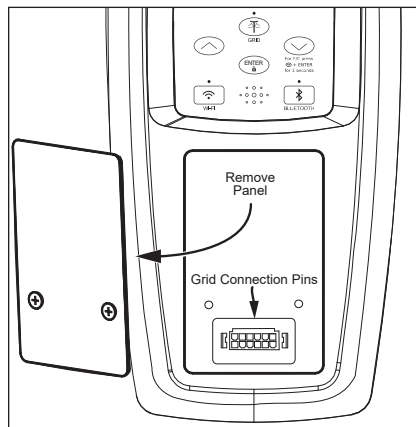

Figure 30 - Accessing EcoPort CTA-2045 communication port.

NOTICE: Use only approved grid communication adaptors. This will enable the power company to communicate the peak demand periods for the water heater's power usage.

After this connection is made, the grid control is automatically enabled. Press the "Enter" button to confirm UCM is present. This action will be followed by a solid LED from the grid indicator (Figure 31).

Enabling this feature will allow acceptance of the power company communication grid management requests.

NOTICE: The LED will blink when the power company has control of the unit.

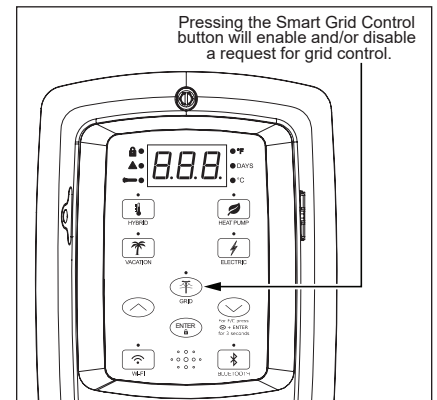

Figure 31 - Smart Grid Control Button

To disable (override) grid control, press the "Smart Grid Control" button (Figure 31). This action will be followed by a 72 hour timer. Remove CTA 2045 UCM. Press the "Enter" button to confirm the disconnection. The LED will turn off.

NOTICE: If the CTA 2045 UCM is not removed followed by pressing the "Enter" button, the grid will be enabled automatically once the 72 hour timer has expired.

TROUBLESHOOTING

CONTROL ASSEMBLY DIAGNOSTIC CODE CHART

IMPORTANT: Before attempting to adjust the thermostat, read the “Important Safety Information” section on page 4. If the instructions are not clear, contact a qualified person.

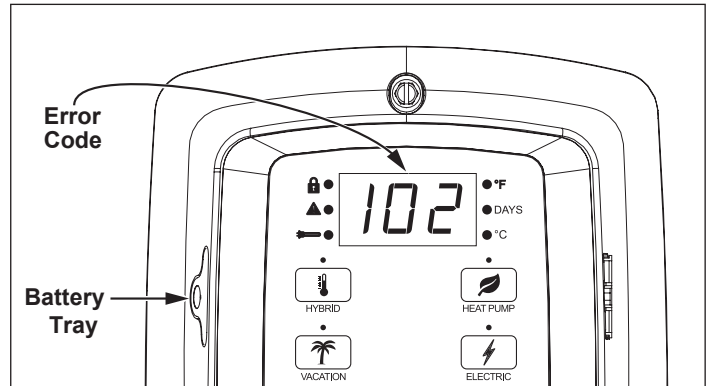

Figure 32 - Control Assembly Diagnostic Coding.

ERROR CODE	INDICATES	CORRECTIVE ACTION*
No Error Code Displayed Not Enough Hot Water	High usage, plumbing leak, operating mode adjustment	<ol style="list-style-type: none"> 1. Check for plumbing leak. 2. Adjust temperature; see scald warnings on heater and in manual. 3. Contact a qualified person to perform a volume test.
No Error Code Displayed Water Too Hot	Water temperature set too high or grounded element	<ol style="list-style-type: none"> 1. Reduce temperature setting. 2. Contact a qualified person to test for ground element and replace if necessary.
No Error Code Displayed No Hot Water	No power, control panel or thermostat operation	<ol style="list-style-type: none"> 1. Turn off electrical power at breaker. 2. Unplug and reconnect 24 pin connector. 3. Turn on electrical power at breaker. 4. Contact a qualified person to verify correct voltage to unit. <p>NOTICE: If the control panel was not connected via Wi-Fi or Bluetooth, the time will need to be set.</p>
001 with an alert icon flashing. (also flashing red LED and beeper.)	Dry-fire, electrical power on with the tank not completely full of water	<ol style="list-style-type: none"> 1. Turn off electrical power at breaker. Add water, open a hot water faucet to bleed all air until water flows without air bursts. 2. Turn on electrical power at breaker. 3. See “Important Safety Information” on page 4.
003 with an alert icon flashing. (also flashing red LED.)	Upper thermistor sensor failure NOTICE: Upper thermistor sensor is part of the thermostat	<ol style="list-style-type: none"> 1. Turn off electrical power at the breaker. 2. Check electrical connections at thermostat. 3. If there are no issues with the wiring, replace the thermostat. 4. Turn on electrical power at breaker. <p>NOTICE: The control panel will go into Limp Mode until the failure is corrected. See page 28.</p>
004 with an alert icon flashing. (also flashing red LED.)	Lower thermistor sensor failure NOTICE: Lower thermistor sensor is part of the thermostat	<ol style="list-style-type: none"> 1. Turn off electrical power at the breaker. 2. Check electrical connections at thermostat. 3. If there are no issues with the wiring, replace the thermostat. 4. Turn on electrical power at breaker. <p>NOTICE: The control panel will go into limp mode until the failure is corrected. See page 28.</p>
006 with an alert icon flashing. (also flashing red LED and beeper.)	Internal Processor Error - Frequency Fault - Standard AD Reference Fault - Non-Volatile Memory Fault - Crystal Fault	<ol style="list-style-type: none"> 1. Turn off electrical power at the breaker. Now turn on electrical power to see if error clears. If error has not cleared, replace the control assembly. 2. Turn on electrical power at breaker.
009 with an alert icon flashing. (with flashing red LED.)	Power supply voltage is too low or too high	Check for loose electrical connections, refer to “Power Cycling the Unit” on page 31.

TROUBLESHOOTING

TROUBLESHOOTING

ERROR CODE	INDICATES	CORRECTIVE ACTION*
021 with an alert Icon flashing. (also flashing red LED.)	Upper element circuit failure NOTICE: Lower element is still operable	<ol style="list-style-type: none"> 1. Turn off electrical power at the breaker. 2. Check element circuits for resistance of 5-25 ohms (replace if required). 3. Check wires at elements and thermostat for damage. 4. Turn on electrical power at breaker. 5. If the error persists, contact a qualified person. NOTICE: The Control Assembly will go into limp mode until failure is corrected. See page 28.
022 with an alert Icon flashing. (also flashing red LED.)	Lower element circuit failure NOTICE: Upper element is still operable	<ol style="list-style-type: none"> 1. Turn off electrical power at the breaker. 2. Check element circuits for resistance of 5-25 ohms (replace if required). 3. Check wires at elements and thermostat for damage. 4. Turn on electrical power at breaker. 5. If the error persists, contact a qualified person. NOTICE: The Control Assembly will go into limp mode until failure is corrected. See page 28.
025 with an alert Icon flashing. (with flashing red LED.)	Heat Pump Coil Temperature Sensor is not functioning	<ol style="list-style-type: none"> 1. Power off ("Power Cycling the Unit," page 31). 2. Disconnect and reconnect the J9 connection from control board. 3. Inspect wire for damage. 4. Re-install Control Assembly. 5. Reconnect power. 6. If error persists, replace temperature sensor.
026 with an alert Icon flashing. (with flashing red LED.)	Heat Pump Suction Temperature Sensor is not functioning	<ol style="list-style-type: none"> 1. Power off ("Power Cycling the Unit," page 31). 2. Disconnect and reconnect the J9 connection from control board. 3. Inspect wire for damage. 4. Re-install Control Assembly. 5. Reconnect power. 6. If error persists, replace temperature sensor.
027 with an alert Icon flashing. (with flashing red LED.)	Heat Pump Discharge Temperature Sensor is not functioning	<ol style="list-style-type: none"> 1. Power off ("Power Cycling the Unit," page 31). 2. Disconnect and reconnect the J9 connection from control board. 3. Inspect wire for damage. 4. Re-install Control Assembly. 5. Reconnect power. 6. If error persists, replace temperature sensor.
028 with an alert Icon flashing. (also flashing red LED and beeper.)	Ambient Temperature Sensor failure (Heat Pump Compressor is outside of operational temperature range)	<ol style="list-style-type: none"> 1. Turn off electrical power at the breaker. 2. Turn on electrical power at breaker to see if code clears. If error persists, call our Technical Assistance Hotline which is listed on the water heater's warranty sheet for further assistance.
031 with an alert Icon flashing. (also flashing red LED and beeper.)	Water Leak	<ol style="list-style-type: none"> 1. Turn off electrical power at the breaker, check all electrical connections, and wiring for damage. 2. Check for plumbing leaks and correct accordingly. 3. If tank is leaking, replace the unit. 4. Turn on electrical power at breaker.
044 with an alert Icon flashing. (with flashing red LED.)	SAC anode depleted	<ol style="list-style-type: none"> 1. Turn off electrical power. Shut off the cold water valve at the main line and open a hot water faucet to release pressure from the water heater. 2. Remove anode rod (see step 7 on page 32). 3. Inspect anode rod and replace if necessary.
046 with an alert Icon flashing. (also flashing red LED and beeper.)	Shut-off Valve (if applicable)	<ol style="list-style-type: none"> 1. Turn off electrical power. Shut off the cold water valve at the main line and open a hot water faucet to release pressure from the water heater. 2. Check the shut-off valve, making sure the valve is not stuck in the open or closed position. 3. Replace the shut-off valve, if needed. 4. Turn on electrical power at breaker. 5. Open the cold water valve to fill the heater with water, open a hot water faucet to bleed all air until water flows without air bursts.

TROUBLESHOOTING

ERROR CODE	INDICATES	CORRECTIVE ACTION*
048 with an alert icon flashing. (with flashing red LED.)	Battery Low Energy	<ol style="list-style-type: none"> 1. Make sure the battery protective tab has been properly removed from the battery tray, located on the left side of the Control Assembly. 2. Locate the battery tray on the side of the control assembly. 3. Remove the Phillips head screw, slide the battery tray out from the Control Assembly. 4. Remove the old BR2032 battery and replace with a new Panasonic® BR2032 or Murata CR3032 battery. 5. Reinstall the battery tray with new battery and hand tighten the Phillips head screw to secure the battery tray in the Control Assembly. <p>NOTICE: If the control assembly was not connected via Wi-Fi, Bluetooth, or powered by a power source, the time will need to be set.</p>
080 with an alert icon flashing. (with flashing red LED.)	Air filter is dirty	<ol style="list-style-type: none"> 1. Take the tab on the air filter and remove (slide) it from the air intake duct adaptor located on the top of the unit. 2. If you are replacing the filter, skip to step four. To clean the filter, use a vacuum with a hose attachment to remove any dust or debris. 3. Place the new or cleaned filter into the water heater. 4. Turn on electrical power at breaker.
081 with an alert icon flashing. (with flashing red LED and beeper.)	Condensate management	<ol style="list-style-type: none"> 1. Ensure unit is installed level. 2. Check for blocked condensate drain line, clear drain line as necessary. 3. If an accessory condensate pump was installed: Turn off power to the water heater at the breaker and check control wire connections to condensate pump. See "Connecting the Condensate Pump Optional Overflow Shut-Off Switch" on page 11. 4. Check to see if the accessory condensate pump is plugged in and has power. 5. Ensure the pump is operating properly, check pump outlet tube for blockage. 6. Repair or replace accessory condensate pump as necessary. 7. If problem persists, call our Technical Assistance Hotline which is listed on the water heater's warranty sheet.
083 with an alert icon flashing. (with flashing red LED and beeper**.)	Heat Pump Compressor suction pressure is too low	Call our Technical Assistance Hotline which is listed on the water heater's warranty sheet for further assistance.
084 with an alert icon flashing. (with flashing red LED and beeper**.)	Heat Pump Compressor is not functioning	Call our Technical Assistance Hotline which is listed on the water heater's warranty sheet for further assistance.
085 with an alert icon flashing. (with flashing red LED and beeper**.)	Heat Pump Compressor discharge temperature is too high	Call our Technical Assistance Hotline which is listed on the water heater's warranty sheet for further assistance.
086 with an alert icon flashing. (with flashing red LED and beeper***.)	Fan speed feedback	Call our Technical Assistance Hotline which is listed on the water heater's warranty sheet for further assistance.

*These instructions are brief and intended as guidance for a qualified person. If you lack the necessary skills to perform these procedures call the Technical Assistance Hotline which is listed on the water heater's warranty sheet for assistance.

**Audible alarm will beep if error code is triggered three (3) times in one (1) hour.

***Audible alarm will beep if error code is triggered three (3) times in seventy-two (72) hours.

TROUBLESHOOTING

▲ WARNING! Working near an energized circuit can result in severe injury or death from electrical shock.

▲ WARNING! When you are finished, be sure all covers are secured to reduce the risk of fire and electric shock.

Troubleshooting & Maintenance

If you are not qualified or are not comfortable performing any of the troubleshooting, repair or maintenance procedures that follow, call our Technical Assistance Hotline for further assistance.

Limp Mode

The heater will continue operating with one failed heating method by switching into Limp Mode:

- If the control module determines that the lower thermistor or lower element has failed, the lower element call for heat will be canceled. The upper element call for heat will still allow the upper element to heat the water as needed.
- If the control module determines that the upper thermistor or upper element has failed, the lower element will be allowed to heat the water as needed.

NOTICE: The Control Assembly will operate in Limp Mode until the failure is corrected.

No Hot Water

The most likely reasons for an electric water heater to produce NO hot water are:

- No power to the water heater (no lights on the unit are activated).
- Unit in Vacation Mode.
- ECO tripped.
- Hot water usage pattern exceeds the capability of the water heater in current mode.
- Non-functioning upper temperature sensor.
- Faulty thermostatic mixing valve.
- Leak in plumbing system.

Follow these steps to diagnose and correct common electrical problems:

1 Check the Electrical Power to the Water Heater.

No hot water is often caused by a problem with the home's electrical wiring or circuit breakers. You will need a non-contact circuit tester. Follow these guidelines:

- Locate the water heater's circuit breaker and turn it off (or remove the circuit's disconnects).
- Locate the electrical junction box on the side of the water heater and remove the cover.
- Identify the two power wires. The power wires are usually black/black or black/red. The green or copper wire is the ground wire.



Figure 33 - Use a non-contact circuit tester to check for electrical power.

- Turn the circuit breaker back on (or install the disconnects) and check

the power on both incoming power wires using a non-contact circuit tester.

- Turn the power off and replace the cover on the electrical junction box.

If the water heater is not getting power, contact a qualified person to have your home's wiring or circuit breakers checked.

2 Check the Upper Heating Element.

If the water heater is getting electrical power, check to see if the upper heating element is burned out. If the upper element is burned out, you will have no hot water. To check the upper element, you will need a multimeter capable of reading resistance.

- Turn the power OFF at the circuit breaker or remove disconnects.
- Remove the upper access panel.
- Move the insulation to access the ECO and heating element.

3 Check the Top Two Screws of the ECO Using a Non-Contact Circuit Tester and Confirm

that Power is OFF (screw terminals 1 and 3 in photo on next page).

With the electrical power OFF, remove the two power wires from the upper heating element.

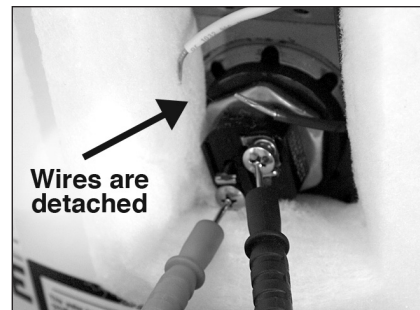

Figure 34 - Use a multimeter to check the resistance of the upper heating element.

TROUBLESHOOTING

4

Check the Resistance of the Upper Heating Element Using a Multimeter.

Measure the resistance between the two screw terminals on the upper heating element. A good element will have a resistance ranging between 5 and 25 Ohms. If the resistance is:

Outside this Range. Replace the element (see “Replacing the Heating Element” on page 33). If the lower element is a concern, repeat the element check procedure for the lower element. The upper and lower elements should have the same resistance range.

Within this Range. Reattach the power wires, making sure the wires are in good condition and the connections are clean and tight.

Check/Reset Energy Cut Off (ECO) Button.

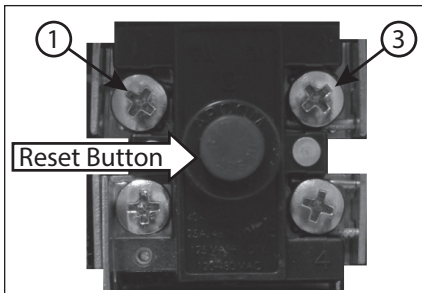

Figure 35 - Energy Cut Off (ECO) Button.

The Energy Cut Off (ECO) shuts off power to the water heater’s elements if the temperature of the water in the tank gets too hot. If the ECO has tripped, you will have no hot water. A tripped ECO can usually be reset, but you should have a qualified person investigate the cause of the overheating and repair the problem. Do not turn the power back on until the cause of the overheating has been identified and repaired.

To Check the Energy Cut Off (ECO):

- Turn off the power to the water heater.

▲ WARNING! Working near an energized circuit can result in severe injury or death from electrical shock. Check power wires in the electrical junction box with a non-contact circuit tester to make sure power is off.

- Press the red ECO reset button (Figure 35).
- The ECO was tripped if you hear a click when it is reset. In most cases, a tripped ECO indicates that the tank overheated due to a problem with one of the elements. Have a qualified person check the upper and lower elements and replace if necessary.
- The ECO was not tripped if you did not hear a click. In that case it should be checked by a qualified person.
- Replace the insulation and the upper access panel.
- Turn the power back on to the water heater.

▲ WARNING! Be sure all covers are secured to reduce the risk of fire and electric shock.

Drips from T&P Relief Valve Discharge Pipe

A small amount of water dripping from the Temperature and Pressure (T&P) Relief Valve usually means the home’s water pressure is too high or you need a properly sized and pressurized Thermal Expansion Tank (see “Step 1” on page 7 for more information). A large amount of hot water coming from the T&P discharge pipe may be due to the tank overheating.

▲ WARNING! Do not cap or plug the T&P Relief Valve or discharge pipe, and do not operate the water heater without a functioning T&P Relief Valve - this could cause an explosion.

Water Pressure too High. High water pressure can cause the T&P Relief Valve to drip. Install a Pressure Reducing Valve (PRV) on the main cold water supply line. Adjust the PRV to between 50-60 psi/345-414 kpa.

Thermal Expansion Tank. Install a Thermal Expansion Tank. If a Thermal Expansion Tank is already installed and the T&P Relief Valve discharge pipe drips, the Thermal Expansion Tank may be pressurized to the wrong pressure or the internal bladder may be defective. Refer to the instructions that came with the Thermal Expansion Tank for more information.

Debris. In rare cases, debris can stick inside the T&P Relief Valve preventing the valve from seating fully. In that case, the T&P Relief Valve discharge pipe will drip. You may be able to clear debris from the T&P Relief Valve by manually operating the valve, allowing small quantities of water to flush out the debris. See the label on the T&P Relief Valve for instructions.

▲ WARNING! When manually operating the T&P Relief Valve, make sure that no one is in front of or around the discharge outlet. The water may be extremely hot and could cause severe burns. Also, ensure that the water discharge will not cause property damage.

If the water pressure is between 50-60 psi/345-414 kpa, a Thermal Expansion Tank is installed and properly pressurized, the valve has been cleared of any debris, and it still drips, the valve may be broken – have a qualified person replace the T&P Relief Valve.

TROUBLESHOOTING

Water Odor

Harmless bacteria normally present in tap water can multiply in water heaters and give off a “rotten egg” smell. A higher tank temperature setting of 140°F/60°C kills the bacteria that causes “smelly water” and can reduce the levels of bacteria that cause water-borne disease. A properly adjusted Thermostatic Mixing Valve should be installed at each point of use.

NOTICE: To protect the tank, an anode rod must be installed in the water heater at all times or the warranty is void.

▲ WARNING! Because higher temperatures increase the risk of scalding, if you set the Control Assembly setting higher than 120°F/49°C, Thermostatic Mixing Valves are particularly important (see page 4).

Water Heater Sounds

During the normal operation of the water heater, sounds or noises may be heard. These noises are common and may result from the following:

- Normal expansion and contraction of metal parts during periods of heat-up and cool-down.
- Sediment buildup on or around the elements could create varying amounts of noise and may cause premature tank failure. Drain and flush the tank as directed (see “Draining and Flushing the Water Heater” on page 32).
- The heat pump compressor or fan running.

Temperature Too High

If the water temperature is too hot:

- Adjust the Control Assembly on the water heater (see “Adjusting the Control Assembly’s Operational Modes” on page 21).
- Install or adjust a Thermostatic Mixing Valve (see manufacturer’s instructions).

A non-functioning thermostat or a shorted heating element can cause extremely hot water. If the Temperature and Pressure (T&P) Relief Valve releases large amounts of very hot water, it is likely due to a shortened heating element, or more rarely a non-functioning thermostat, or the thermostat does not fit snugly against the tank. Very high water temperatures can also cause the Energy Cut Off (ECO) to trip (see “Replacing the ECO” on page 35). Turn power off until this problem is repaired.

Low Water Pressure

Check both the cold and hot water at a sink to determine if the lower pressure is only on the hot water side. If both hot and cold faucets have low pressure, call your local water utility. If the low pressure is only on the hot water side, the primary causes of this are:

- Melted heat traps or dip tube. Soldering copper pipes while they are connected to the water heater can melt the heat traps inside of the hot and cold water connections or the dip tube (cold water side). Melted heat traps or a melted dip tube can restrict the flow of hot water. If that is the case, replace the heat traps or dip tube.
- Partially closed supply valve. Open the water heater’s supply valve fully.

Insufficient or No Hot Water, or Slow Hot Water Recovery

▲ WARNING! Because higher temperatures increase the risk of scalding, if you set the Control Assembly setting higher than 120°F/49°C, Thermostatic Mixing Valves are particularly important (see page 4).

If the hot water is simply not warm enough, there are several possible causes:

- Thermostatic Mixing Valve faulty or set too low.
- Temperature set point too low.
- Hot water usage pattern exceeds the capability of the water heater in current mode (see “Operating Mode Descriptions” on page 19).
- Water connections to unit are reversed (disconnect and re-install correctly).
- Leak in plumbing system (check home for any leaks and repair).
- Lower heating element not functioning properly.
- No power to the water heater (no lights on the unit are on and display is blank).
- Unit is in Vacation Mode.
- ECO tripped.
- Non-functioning upper temperature sensor (refer to code **003** in the “Diagnostic Codes” section on page 25).
- Air filter is dirty (see “Air Filter Maintenance” on page 36).

TROUBLESHOOTING

- Out of position outlet j-tube. Assure orientation of line on tube is in top position (side connections only).

Thermostatic Mixing Valves. If the hot water is simply not warm enough, make sure the faucet you are checking does not have a defective Thermostatic Mixing Valve. If these devices fail, they can reduce the amount of hot water the shower or faucet delivers even though there is plenty of hot water in the tank. Always check the water temperature at several faucets to make sure the problem is not in a faucet or shower control.

Control Assembly Set Too Low. If the water temperature at several faucets is too cool, adjust the Control Assembly (see “Water Temperature Adjustment” on page 21).

Undersized Water Heater. If your water heater runs out of hot water too quickly, it may be too small for your needs. If the water heater is old, consider replacing it with a larger model. If the water heater is in good condition, you may be able to meet your family’s hot water needs with the existing water heater by installing a Thermostatic Mixing Valve and then setting the temperature to a higher setting on the Control Assembly (see “Water Temperature Adjustment” on page 21).

You can also reduce your home’s hot water needs by washing clothes in cold water, installing flow restrictors on shower heads, repairing leaky faucets, and taking other conservative steps.

Reversed Connections or Melted J-tube. Check the hot and cold connections and make sure your home’s hot water pipe is connected to the hot water outlet on the water heater. Usually, reversed connections

are found soon after the installation of a new unit. If copper pipes were soldered while they were attached to the water heater, the J-tube may have melted. The J-tube is a curved plastic tube inside the tank attached to the cold water inlet. If the J-tube has melted, it can be replaced by removing the old J-tube and installing a new one.

Plumbing Leak. Even a small leak in the hot water side of the home’s plumbing system can make it appear that the water heater is producing little or no hot water. Locate and repair the leak.

Lower Heating Element Not Working. If the lower heating element is not working, you will have some hot water but not as much as before. Because the lower element does most of the work, it usually wears out before the upper element. Replace the lower element if necessary (see “Replacing the Heating Element” on page 33).

Power Cycling the Unit

- 1** Find and turn off the water heater’s circuit breaker or remove disconnects.
- 2** Locate the electrical junction box on side of water heater, remove cover and identify the two (2) power wires.
- 3** Turn circuit breaker back on (or re-install the disconnects) and check for power on both incoming power wires using a multimeter.
- 4** Again, turn off the water heater’s circuit breaker, or remove the disconnects and replace the electrical junction box cover, before performing maintenance work.

NOTICE: When powered on the unit will start to run a system diagnostic. The diagnostic sequence typically takes seven (7) to ten (10) minutes. During this period the Control Assembly will display a series of single, alternating dashes repetitively.

▲ WARNING! Working near an energized circuit can result in severe injury or death from electrical shock.

▲ WARNING! When you are finished, be sure all covers are secured to reduce the risk of fire and electric shock.

MAINTENANCE

Routine Maintenance

Routine maintenance will help your water heater last longer and work better. If you cannot perform these routine maintenance tasks yourself, contact a qualified person.

Water Heater Maintenance

After the first six months, drain and flush the water heater and inspect the anode rod. Depending on the hardness of your water, repeat this process at least annually, or more frequently if needed. From time to time you may need to replace a heating element or a thermostat. All three maintenance tasks are described below.

Draining and Flushing the Water Heater

Tap water contains minerals that can form lime deposits on heating elements or sediment in the bottom of the tank. The amount of lime deposits or sediment depends on the hardness of your tap water. The rate at which sediment builds up depends on water quality and hardness in your area, the temperature settings, and other variables. We recommend draining and flushing the water heater after the first six months of operation to determine the amount of sediment buildup. Draining sediment extends the life of the tank, heating elements, and drain valves.

- In areas with very hard water, remove and check the heating elements whenever you drain the tank. If you have heavy lime deposits on heating elements, you will need to replace them more often.

- Sediment may form large masses that can prevent the tank from draining. Have a qualified person use a deliming agent suitable for potable water to remove the sediment buildup.
- In most cases, it is easier and less expensive to replace lime-encrusted elements than trying to remove heavy lime deposits.

To Drain and Flush the Tank

- 1 Locate the water heater's circuit breaker and turn it OFF (or remove the circuit's fuses).



Figure 36 - Circuit Breaker.

- 2 Open a hot water faucet and let the hot water run until it is cool.



Figure 37 - Water Faucet.

▲ WARNING! Be sure the water runs cool before draining the tank to reduce the risk of scalding.

- 3 Connect a garden hose to the drain valve and place the other end of the hose in a drain, outside, or in buckets.
- 4 Turn the cold water supply valve OFF.

- 5 Open the drain valve on the water heater.

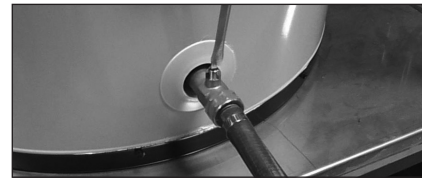

Figure 38 - Drain Valve.

- 6 Open a hot water faucet to help the water in the tank drain faster.

NOTICE: DO NOT turn electrical power back on unless the tank is completely full of water. This is an additional precaution to protect the elements against dry fire. Dry fire occurs when power is supplied to the electric elements without sufficient water in the heater. Dry firing the unit will result in immediate failure of the element. While this unit is equipped with dry fire protection, the recommended practice is to ensure the tank is filled with water prior to supplying power to the unit.

- 7 Remove and inspect the anode rod (see "Repair Parts" illustration on page 39 for location of the anode rod). To replace the anode rod if it is depleted: Turn the power off. Run hot water until it is cool. Turn cold water supply valve off. Open a hot water faucet to depressurize tank.

Remove ducting from unit. Disconnect cold water supply and hot water supply connections from top of unit. Remove the six (6) screws located around the perimeter of the jacket cover. Locate and remove the two (2) screws on top of the unit fastening the jacket cover to the heat pump evaporator. Lift the jacket cover up and away from the unit to gain access to the anode rod.

MAINTENANCE

Once the anode rod is exposed, remove the top nut with a 10 mm hex socket wrench and remove the wire terminal (do not remove lower hex nut from bolt). With the wire terminal removed, use a 1-1/16" socket wrench with an extension to remove the anode rod. Inspect the anode rod and replace if depleted. Apply thread sealant tape or pipe joint compound and reinstall the anode rod tightly. Connect the wire terminal and secure with hex nut. Turn cold water supply valve on. When hot water runs full, close hot water faucet. Check for leaks and repair if necessary. Turn power on.

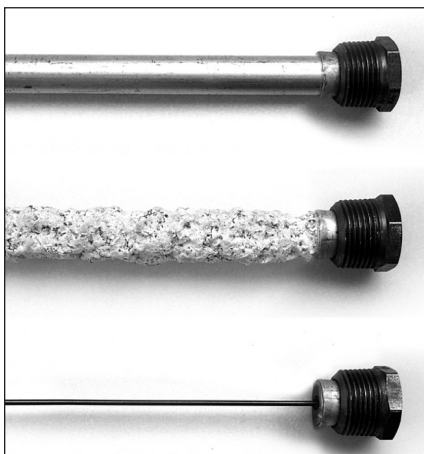

Figure 39 - Anode Rods from new (top) to partially depleted (middle) to fully depleted stages (bottom).

Anode Rod. The anode rod is a sacrificial metal rod that helps reduce corrosion and premature failure (leaks) in the tank. The anode rod is a consumable item. Inspect the anode rod after the first six months of operation when you drain and flush the tank. Replace the anode rod if it is substantially worn out or depleted. Thereafter, inspect the anode rod annually or more frequently if needed. If you use a water softener, your anode rod will deplete faster than normal. Inspect the anode rod more frequently, replacing the anode rod as needed. Obtain new anode rods from

your local plumbing supplier or have a qualified person replace it (anode rods are a consumable item and are not covered under warranty).

NOTICE: The Control Assembly will display error code **044** when the anode rod has been depleted.

8 If sediment was present when the tank was drained, flush the tank by opening the cold water supply valve and letting the water run until no more sediment drains from the tank. Close the drain valve when you are done.

NOTICE: DO NOT turn power back on until the tank is completely full of water. For complete instructions on filling the tank, follow "Step 13" on page 16 in the installation section of this manual.

9 Refill the tank by opening the cold water supply valve. Make sure a hot water faucet is open and the drain valve is closed. Allow the hot water to run full for at least three minutes to make sure the tank has all the air removed and is completely full of water. Failure to perform this step can cause the upper heating element to burn out. Once you are certain the tank is completely full of water, close the hot water faucet.

10 Turn ON power to the water heater at the circuit breaker/fuse box. It may take two hours for the tank to heat up.

Replacing the Heating Element

▲ WARNING! Working near an energized circuit can result in severe injury or death from electrical shock. Turn power OFF. Check wires with a non-contact circuit tester to make sure power is OFF. When you

are finished, be sure all covers are secured to reduce the risk of fire and electric shock.

If you are not comfortable replacing a heating element or thermostat yourself, have this work done by a qualified person. To replace the heating element, you will need the following tools and supplies:



Figure 40 - Non-Contact Circuit Tester.

- Always turn power OFF and check the power wires with a non-contact circuit tester before working on the water heater.

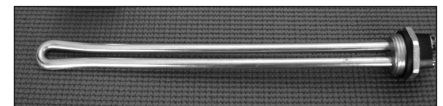

Figure 41 - Heating Element (with gasket).

- Check your water heater's data plate for the correct wattage and voltage. Heating elements are available at your local plumbing supplier.



Figure 42 - Element Wrench.

- Some regular sockets (1-1/2 inch) may work, but regular sockets are often beveled and may slip. Inexpensive element wrenches are available at your local plumbing supplier.
- Garden hose to drain the tank.
- Hand dishwashing soap to lubricate the gasket.

MAINTENANCE

- A clean cloth to clean the threaded opening.
- A flat blade and Phillips screwdriver.

Steps for Replacing the Heating Element:

NOTICE: A diagnostic code (see “Control Assembly Diagnostic Code Chart” on page 25) should indicate if the upper or lower element has failed.

- 1 Turn the power OFF at the circuit breaker or remove fuses.



Figure 43 - Circuit Breaker.

- 2 Open the electrical junction box on the side of the water heater. Using a non-contact circuit tester, check the power wires to make certain the power is OFF.



Figure 44 - Non-Contact Circuit Tester.

- 3 Open a hot water faucet and let the hot water run until it is cool.



Figure 45 - Water Faucet.

▲ WARNING! Be sure the water runs cool before draining the tank to reduce the risk of scalding.

- 4 Connect a garden hose to the drain valve and place the other end of the hose in a drain or outside (or use buckets). Turn OFF the cold water valve that supplies the water heater. Open the drain valve on the water heater. Opening a hot water faucet will help the tank drain faster.

- 5 Remove the upper or lower access panel on the water heater, and then fold back the insulation and remove the plastic element/thermostat cover.



Figure 46 - Access Panel.

- 6 With the tank drained and the power OFF, remove the power wires from the element you intend to replace.
- 7 Remove the bad element using an element wrench.
- 8 Make sure the new element is the correct replacement by referring to the water heater’s data plate for voltage and wattage information.
- 9 Clean the threads in the tank opening with a rag. Insert the new element equipped with a rubber gasket. Use a drop of hand dishwashing liquid to lubricate the gasket to help avoid damaging the gasket as it is being tightened. Tighten with an element wrench.

NOTICE: DO NOT turn power back on until the tank is completely full of water. For complete instructions on filling the tank, follow “Step 13” on page 16 in the installation section of this manual.

- 10 Refill the tank by opening the cold water supply valve. Make sure a hot water faucet is open and the drain valve is closed. Allow hot water to run full for at least three minutes to make sure the tank has all the air removed and is completely full of water. Failure to perform this step can cause the upper heating element to burn out. Once you are certain the tank is completely full of water, close the hot water faucet.



Figure 47 - Drain Valve.

- 11 Check the newly installed element for leaks. If a leak is present, tighten the element until the leak stops. If you cannot stop the leak, drain the tank and remove the element. Inspect the gasket for damage. If the gasket is damaged, replace the gasket and reinstall the element.
- 12 Once the element is successfully installed and there are no leaks, replace the power wires, thermostat cover, insulation, and access panel. Make sure all wire connections are tight. Replace the cover on the electrical junction box.
- 13 Turn ON power to the water heater at the circuit breaker/fuse box. It may take two hours for the tank to heat up.

MAINTENANCE

Replacing the ECO

▲ WARNING! Working near an energized circuit can result in severe injury or death from electrical shock. Turn power OFF. Check wires with a non-contact circuit tester to make sure power is OFF. When you are finished, be sure all covers are secured to reduce the risk of fire and electric shock.

To replace the ECO, you will need the following tools and supplies:

- A non-contact circuit tester. Always turn power OFF and check with a non-contact circuit tester before working on the water heater.

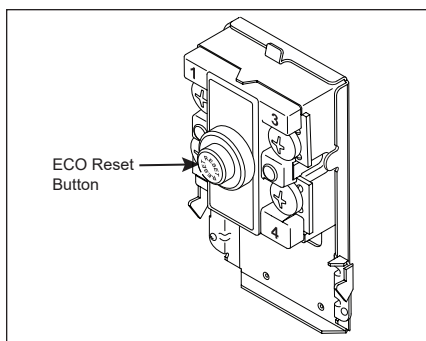

Figure 48 - ECO

- A replacement ECO (see the “Repair Parts” list on page 39).
- A business card to check the gap between the ECO and tank.
- Tape and a permanent marker to mark the wires.
- A flat blade and Phillips screwdriver.

Steps for Replacing the ECO:

- 1** Turn the power OFF at the circuit breaker or remove fuses.
- NOTICE:** It is not necessary to drain the tank to replace an ECO.
- 2** Open the electrical junction box on the side of the water heater. Using a non-contact circuit tester, check the power wires to make certain the power is OFF.

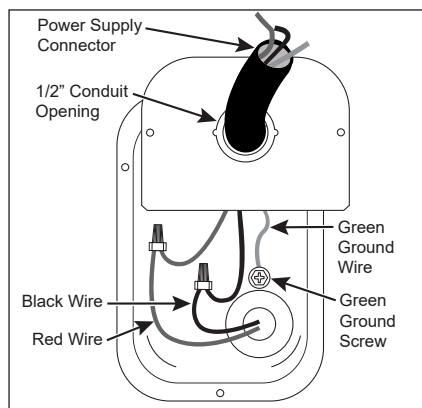

Figure 49 - Electrical Junction Box (bottom cover to electrical junction box removed for clarity).

- 3** Remove the upper access panel on the water heater and carefully fold back the insulation and plastic element/ECO cover (Figure 50).
- 4** Make sure the replacement ECO matches the original ECO.
- 5** Mark the wires with tape so you will know how to put them back on.
- 6** Disconnect the wires from the bad ECO and remove the ECO from the metal mounting clip.
- 7** Install the new ECO in the metal mounting clip.

- 8** Make sure the new ECO fits snugly against the tank. You should NOT be able to slip a business card between the ECO and the tank. If you can, bend the ECO mounting clip until the ECO fits tightly against the tank.
- 9** Attach the wires following the wiring diagram on the water heater’s label. Make sure all wire connections are tight.
- 10** Replace the plastic element/ECO cover, insulation, and access panel.
- 11** Replace the cover on the electrical junction box.
- 12** Turn ON power to the water heater at the circuit breaker/fuse box.

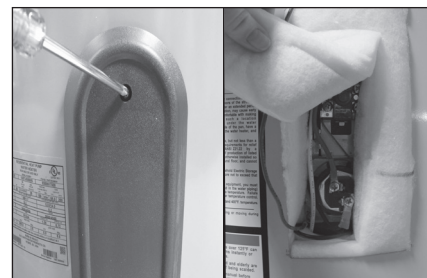

Figure 50 - Element Access Panel/ECO Compartment.

T&P Relief Valve Maintenance

Read and follow the operating and annual maintenance instructions provided by the manufacturer of the T&P Relief Valve (yellow label attached to the T&P Relief Valve). If no label is attached to the T&P Relief Valve, follow the instructions in this section. Minerals in the water can form deposits that cause the valve to stick or create blocked passages, making the T&P Relief Valve inoperative. Follow these guidelines:

MAINTENANCE

- At least annually, operate the T&P Relief Valve manually to ensure the waterways are clear and the valve mechanism moves freely. Before operating the valve manually, check that it will discharge in a place for secure disposal. If the water does not flow freely from the end of the discharge pipe, turn OFF the power to the water heater. Call a qualified person to determine the cause.

▲ WARNING! Hot water will be released. Before operating the T&P Relief Valve manually, check that it will discharge in a safe place. If water does not flow freely from the end of the discharge pipe, turn the power to the water heater OFF. Call a qualified person to determine the cause.



Figure 51 - T&P Relief Valve.

- At least every five years, have a qualified person inspect the T&P Relief Valve and discharge pipe. Damage caused by corrosive water conditions, mineral deposits, or other problems can only be determined when a qualified person removes and inspects the valve and its components.
- Note that a dripping T&P Relief Valve is usually caused by the home's water pressure being too high or the lack of a Thermal Expansion Tank. If your T&P Relief Valve drips, see "Drips from T&P Relief Valve Discharge Pipe" on page 29.

Air Filter Maintenance

The heater will monitor the heat pump operation status and indicate whether the filter should be cleaned. If the Control Assembly displays the code **080**, this indicates the filter should be cleaned or replaced with the following process (see exploded view of the unit on page 38 for air filter location).

NOTICE: Before attempting to clean or replace the air filter, turn OFF the power to the water heater at the circuit breaker/fuse box.

- 1 Take the tab on the air filter and remove (slide) it from the top facing air intake duct adaptor.
- 2 To clean the filter, use a vacuum with a hose attachment to remove any dust or debris.
- 3 Slide the new or cleaned filter into the air intake duct adaptor.
- 4 Turn ON power to the water heater at the circuit breaker/fuse box.

NOTICE: The water heater may conduct a system diagnostic prior to operation.

Condensate Drain Maintenance

NOTICE: Before attempting to clean the condensate drain pan or lines, turn OFF power to the water heater at the circuit breaker/fuse box.

- 1 Check the condensate drain pan and drain lines for any dirt or debris that might interfere with proper drainage.

- 2 Use a pipe cleaner to clear debris from condensate drain, condensate line, and condensate drain pan.

- 3 Once the condensate drain pan and lines have been inspected/cleaned, turn ON power to the water heater at the circuit breaker/fuse box.

NOTICE: The water heater will conduct a system diagnostic prior to operation.

Control Assembly Battery Maintenance

▲ CAUTION! Battery may explode if mistreated. DO NOT recharge, disassemble or dispose of in fire.

It is recommended to replace the battery in the Control Assembly every 5 years for reliability.

Locate the battery tray on the left side of the Control Assembly (Figure 52).

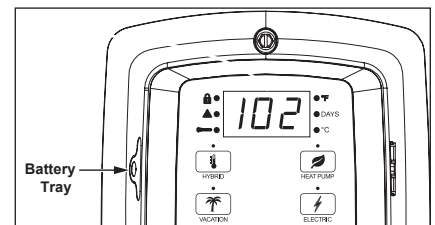

Figure 52 - Battery Tray location.

Replace the BR2032 or CR3032 battery by removing the Phillips head screw and sliding the battery tray with battery out from the Control Assembly. Insert the new Panasonic® BR2032 or Murata CR3032 battery into the tray and reinstall into the Control Assembly. Hand tighten the Phillips head screw to secure the tray in the Control Assembly.

NOTICE: If the Control Assembly was not connected via Wi-Fi, Bluetooth, or powered by a power source, the time will need to be set.

DIAGRAMS

Control Assembly and Thermostat Wiring Diagram

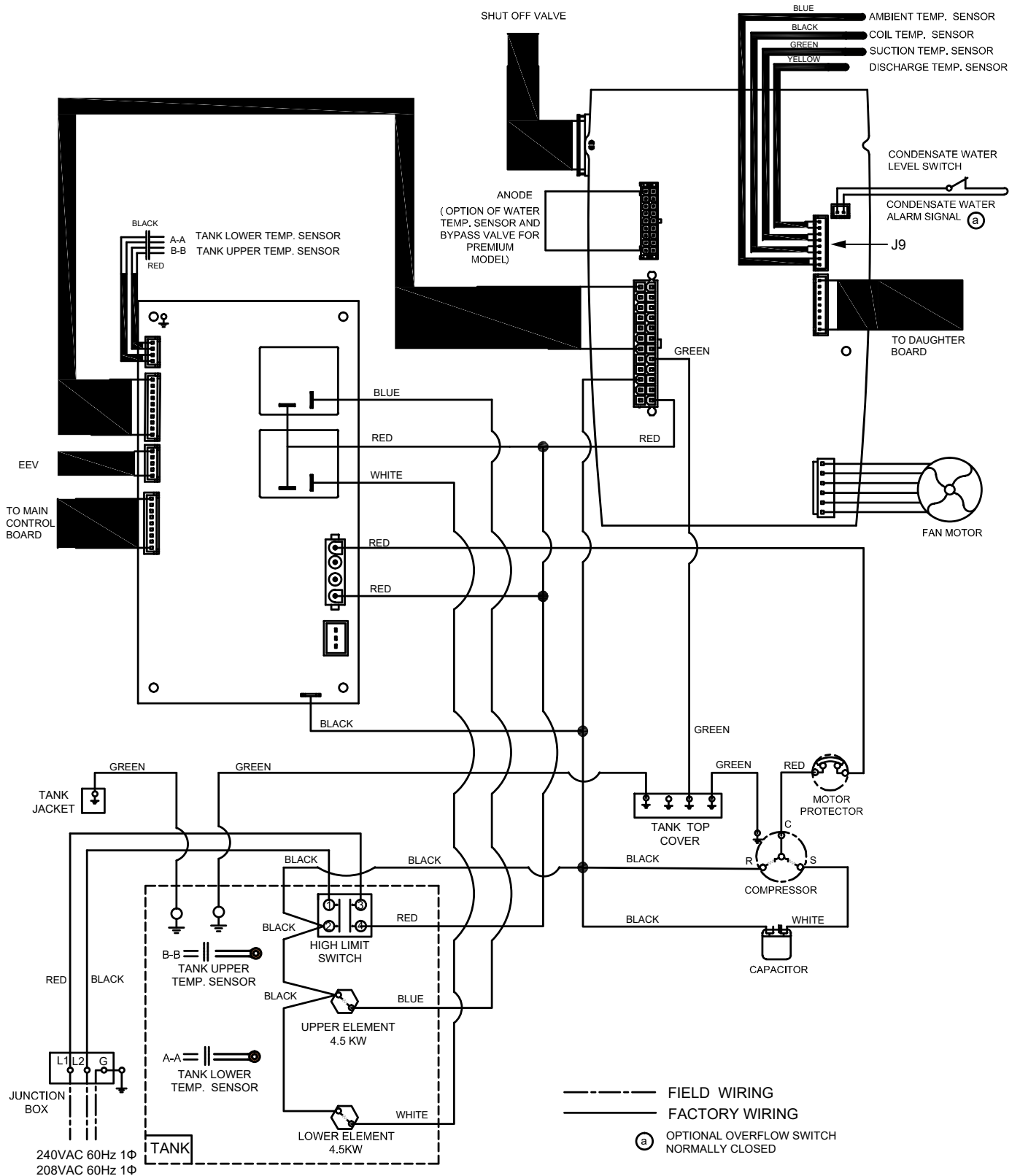

DIAGRAMS

REPAIR PARTS

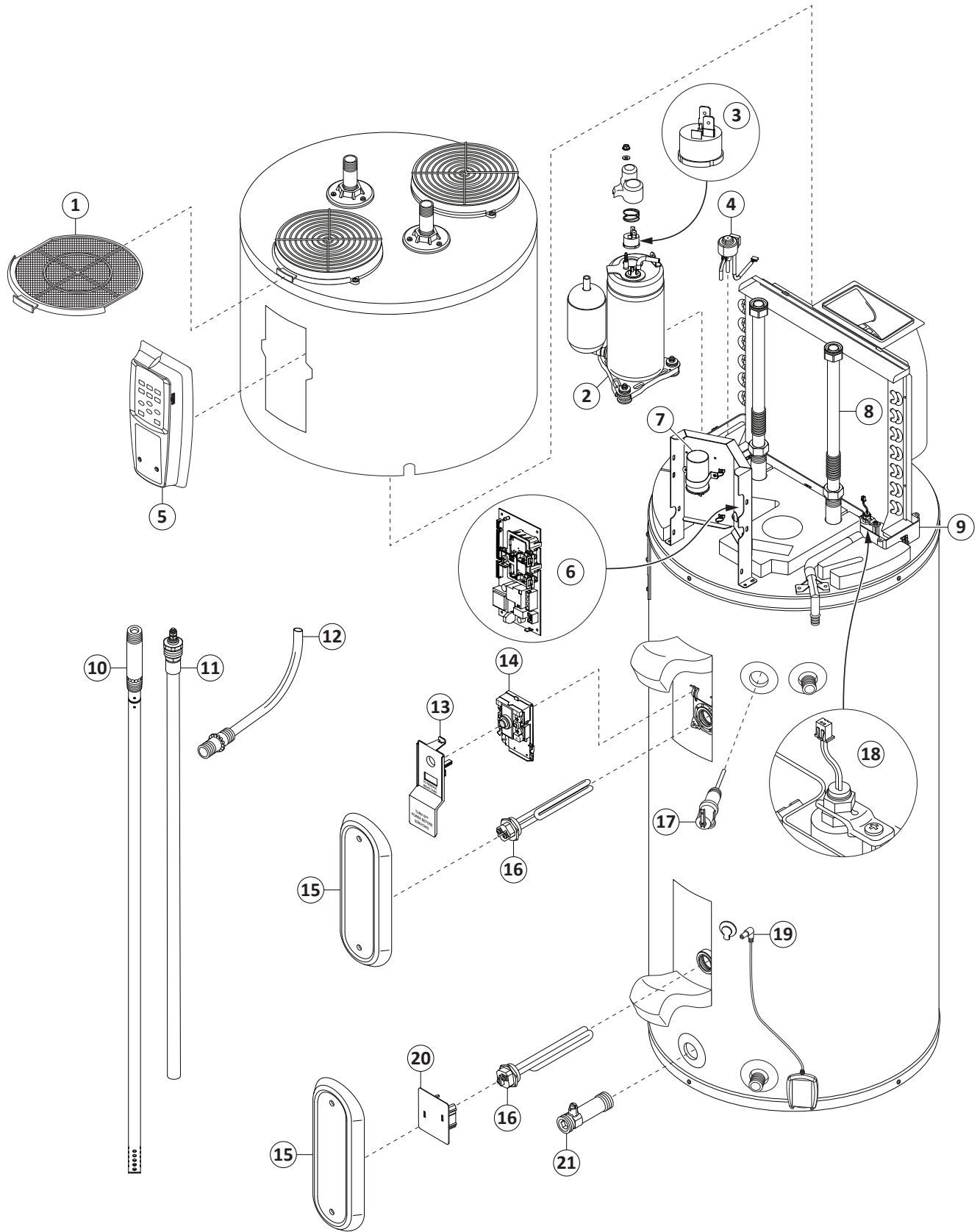

REPAIR PARTS

REPAIR PARTS

REPAIR PARTS

Repair parts may be ordered through your plumber, local distributor, home improvement center, or by calling our Technical Assistance Hotline which is listed on your warranty. When ordering parts, always give the following information:

1. Model, serial and product number
2. Item number
3. Parts description

ITEM NO.	PARTS DESCRIPTION
1	Air Filter
2	208V Compressor
3	Overload Protector
4	Electronic Expansion Valve Coil
5	Control Assembly
6	Control Board, 208V/240V
7	Run Capacitor
8	Hoses (2x), Gaskets
9	Condensate Drain Pan
10	Dip Tube, for 50 gallon
	Dip Tube, for 66 gallon
	Dip Tube, for 80 gallon
11	Anode Rod, 37" for all models
12	J-Tube, for 50 gallon
	J-Tube, for 66 and 80 gallon
13	Upper Element Personnel Protector
14	Energy Cut-Off (ECO) Switch
15	Element Access Panel
16	Element, 4500 Watts
17	Temperature & Pressure Relief Valve
18	Condensate Float
19	Leak Detection Sensor
20	Lower Element Personnel Protector
21	Drain Valve
22*	Automatic Cold Water Shut-Off Valve

*Part not shown.

