

CONDENSING UNIT

AIR CONDITIONING

INSTALLATION & SERVICE REFERENCE

© 2014, 2016-2024

Daikin Comfort Technologies Manufacturing, L.P.
19001 Kermier Rd., Waller, TX 77484

www.goodmanmfg.com -or- www.amana-hac.com

P/N: IO-449M Date: January 2024

IMPORTANT SAFETY INSTRUCTIONS

The following symbols and labels are used throughout this manual to indicate immediate or potential safety hazards. It is the owner's and installer's responsibility to read and comply with all safety information and instructions accompanying these symbols. Failure to heed safety information increases the risk of personal injury, property damage, and/or product damage.



WARNING

ONLY PERSONNEL THAT HAVE BEEN TRAINED TO INSTALL, ADJUST, SERVICE, MAINTENANCE OR REPAIR (HEREINAFTER, "SERVICE") THE EQUIPMENT SPECIFIED IN THIS MANUAL SHOULD SERVICE THE EQUIPMENT.

THIS EQUIPMENT IS NOT INTENDED FOR USE BY PERSONS (INCLUDING CHILDREN) WITH REDUCED PHYSICAL, SENSORY OR MENTAL CAPABILITIES, OR LACK OF EXPERIENCE AND KNOWLEDGE, UNLESS THEY HAVE BEEN GIVEN SUPERVISION OR INSTRUCTION CONCERNING USE OF THE APPLIANCE BY A PERSON RESPONSIBLE FOR THEIR SAFETY.

CHILDREN SHOULD BE SUPERVISED TO ENSURE THAT THEY DO NOT PLAY WITH THE EQUIPMENT.

THE MANUFACTURER WILL NOT BE RESPONSIBLE FOR ANY INJURY OR PROPERTY DAMAGE ARISING FROM IMPROPER SUPERVISION, SERVICE OR SERVICE PROCEDURES. IF YOU SERVICE THIS UNIT, YOU ASSUME RESPONSIBILITY FOR ANY INJURY OR PROPERTY DAMAGE WHICH MAY RESULT. IN ADDITION, IN JURISDICTIONS THAT REQUIRE ONE OR MORE LICENSES TO SERVICE THE EQUIPMENT SPECIFIED IN THIS MANUAL, ONLY LICENSED PERSONNEL SHOULD SERVICE THE EQUIPMENT. IMPROPER SUPERVISION, INSTALLATION, ADJUSTMENT, SERVICING, MAINTENANCE OR REPAIR OF THE EQUIPMENT SPECIFIED IN THIS MANUAL, OR ATTEMPTING TO INSTALL, ADJUST, SERVICE OR REPAIR THE EQUIPMENT SPECIFIED IN THIS MANUAL WITHOUT PROPER SUPERVISION OR TRAINING MAY RESULT IN PRODUCT DAMAGE, PROPERTY DAMAGE, PERSONAL INJURY OR DEATH.



WARNING

DO NOT BYPASS SAFETY DEVICES



WARNING

HIGH VOLTAGE

DISCONNECT ALL POWER BEFORE SERVICING OR INSTALLING THIS UNIT. MULTIPLE POWER SOURCES MAY BE PRESENT. FAILURE TO DO SO MAY CAUSE PROPERTY DAMAGE, PERSONAL INJURY OR DEATH.



CAUTION

SCROLL EQUIPPED UNITS SHOULD NEVER BE USED TO EVACUATE THE AIR CONDITIONING SYSTEM. VACUUMS THIS LOW CAN CAUSE INTERNAL ELECTRICAL ARCING RESULTING IN A DAMAGED OR FAILED COMPRESSOR.

SHIPPING INSPECTION

Always keep the unit upright; laying the unit on its side or top may cause equipment damage. Shipping damage, and subsequent investigation is the responsibility of the carrier. Verify the model number, specifications, electrical characteristics, and accessories are correct prior to installation. The distributor or manufacturer will not accept claims from dealers for transportation damage or installation of incorrectly shipped units.

CODES & REGULATIONS

This product is designed and manufactured to comply with national codes. Installation in accordance with such codes and/or prevailing local codes/regulations is the responsibility of the installer. The manufacturer assumes no responsibility for equipment installed in violation of any codes or regulations. Rated performance is achieved after 20 hours of operation. Rated performance is delivered at the specified airflow. See outdoor unit specification sheet for split system models or product specification sheet for packaged and light commercial models. Specification sheets can be found at www.goodmanmfg.com for Goodman® brand products or www.amana-hac.com for Amana® brand products. Within either website, please select the residential or commercial products menu and then select the submenu for the type of product to be installed, such as air conditioners or heat pumps, to access a list of product pages that each contain links to that model's specification sheet.

The United States Environmental Protection Agency (EPA) has issued various regulations regarding the introduction and disposal of refrigerants. Failure to follow these regulations may harm the environment and can lead to the imposition of substantial fines. Should you have any questions please contact the local office of the EPA.

Should you have any questions please contact the local office of the EPA.



If replacing a condensing unit or air handler, the system must be manufacturer approved and Air Conditioning, Heating and Refrigeration Institute (AHRI) matched. NOTE: Installation of unmatched systems is strongly discouraged.

Outdoor units are approved for operation above 55°F in cooling mode.

Damage to the unit caused by operating the unit in a structure that is not complete (either as part of new construction or renovation) is not covered by the warranty.

This condensing unit is part of a ComfortBridge™ control system designed to more efficiently control heat gain/loss with better efficiency and achieve targeted comfort conditions. The system utilizes digital linkage between the indoor and outdoor equipment and can be controlled by any single-stage thermostat. The ComfortBridge control system reduces the number of required thermostat wires, provides additional setup features and enhanced active diagnostics through Bluetooth connectivity with the downloadable CoolCloud™ app.

INSTALLATION CLEARANCES

Special consideration must be given to location of the condensing unit(s) in regard to structures, obstructions, other units, and any/all other factors that may interfere with air circulation. Where possible, the top of the unit should be completely unobstructed; however, if vertical conditions require placement beneath an obstruction **there should be a minimum of 60 inches between the top of the unit and the obstruction(s)**. The specified dimensions meet requirements for air circulation only. Consult all appropriate regulatory codes prior to determining final clearances.

Another important consideration in selecting a location for the unit(s) is the angle to obstructions. Either side adjacent the valves can be placed toward the structure provided the side away from the structure maintains minimum service clearance. Corner installations are strongly discouraged.

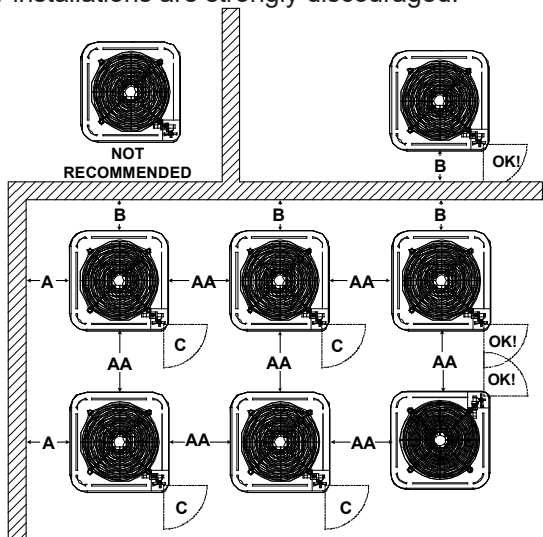

Minimum Airflow Clearance				
Model Type	A	B	C	AA
Residential	10"	10"	18"	20"
Light Commercial	12"	12"	18"	24"

This unit can be located at ground floor level or on flat roofs. At ground floor level, the unit must be on a solid, level foundation that will not shift or settle. To reduce the possibility of sound transmission, the foundation slab should not be in contact with or be an integral part of the building foundation. The dimensions of the space necessary for correct installation of the appliance including the minimum permissible distance to adjacent structures have been covered in this section (per UL 60335-2-40). Ensure the foundation is sufficient to support the unit. A concrete slab raised above ground level provides a suitable base.

ROOFTOP INSTALLATIONS

THESE ARE DESIGNED FOR ALTITUDE:
MAX: 10,500 FEET ABOVE SEA LEVEL
MIN: -184 FEET BELOW SEA LEVEL

If it is necessary to install this unit on a roof structure, ensure the roof structure can support the weight and that proper consideration is given to the weather-tight integrity of the roof. Since the unit can vibrate during operation, sound vibration transmission should be considered when installing the unit. Vibration absorbing pads or springs can be installed between the con-densing unit legs or frame and the roof mounting assembly to reduce noise vibration.

SAFE REFRIGERANT HANDLING

While these items will not cover every conceivable situation, they should serve as a useful guide.

WARNING

TO AVOID POSSIBLE INJURY, EXPLOSION OR DEATH, PRACTICE SAFE HANDLING OF REFRIGERANTS.

WARNING

REFRIGERANTS ARE HEAVIER THAN AIR. THEY CAN "PUSH OUT" THE OXYGEN IN YOUR LUNGS OR IN ANY ENCLOSED SPACE. TO AVOID POSSIBLE DIFFICULTY IN BREATHING OR DEATH:

- NEVER PURGE REFRIGERANT INTO AN ENCLOSED ROOM OR SPACE. BY LAW, ALL REFRIGERANTS MUST BE RECLAIMED.
- IF AN INDOOR LEAK IS SUSPECTED, THOROUGHLY VENTILATE THE AREA BEFORE BEGINNING WORK.
- LIQUID REFRIGERANT CAN BE VERY COLD. TO AVOID POSSIBLE FROSTBITE OR BLINDNESS, AVOID CONTACT AND WEAR GLOVES AND GOOGLES. IF LIQUID REFRIGERANT DOES CONTACT YOUR SKIN OR EYES, SEEK MEDICAL HELP IMMEDIATELY.
- ALWAYS FOLLOW EPA REGULATIONS. NEVER BURN REFRIGERANT, AS POISONOUS GAS WILL BE PRODUCED.

WARNING

TO AVOID POSSIBLE EXPLOSION, USE ONLY RETURNABLE (NOT DISPOSABLE) SERVICE CYLINDERS WHEN REMOVING REFRIGERANT FROM A SYSTEM.

- ENSURE THE CYLINDER IS FREE OF DAMAGE WHICH COULD LEAD TO A LEAK OR EXPLOSION.
- ENSURE THE HYDROSTATIC TEST DATE DOES NOT EXCEED 5 YEARS.
- ENSURE THE PRESSURE RATING MEETS OR EXCEEDS 400 LBS. WHEN IN DOUBT, DO NOT USE CYLINDER.



WARNING

TO AVOID POSSIBLE EXPLOSION:

- NEVER APPLY FLAME OR STEAM TO A REFRIGERANT CYLINDER. IF YOU MUST HEAT A CYLINDER FOR FASTER CHARGING, PARTIALLY IMMERSE IT IN WARM WATER.
- NEVER FILL A CYLINDER MORE THAN 80% FULL OF LIQUID REFRIGERANT.
- NEVER ADD ANYTHING OTHER THAN R-22 TO AN R-22 CYLINDER OR R-410A TO AN R-410A CYLINDER. THE SERVICE EQUIPMENT USED MUST BE LISTED OR CERTIFIED FOR THE TYPE OF REFRIGERANT USED.
- STORE CYLINDERS IN A COOL, DRY PLACE. NEVER USE A CYLINDER AS A PLATFORM OR A ROLLER.

REFRIGERANT LINES



CAUTION

THE COMPRESSOR POE OIL FOR R-410A UNITS IS EXTREMELY SUSCEPTIBLE TO MOISTURE ABSORPTION AND COULD CAUSE COMPRESSOR FAILURE. DO NOT LEAVE SYSTEM OPEN TO ATMOSPHERE ANY LONGER THAN NECESSARY FOR INSTALLATION.



WARNING

PARTIAL UNITS SHALL ONLY BE CONNECTED TO AN APPLIANCE SUITABLE FOR THE SAME REFRIGERANT.

When connecting to an evaporator unit, the maximum operating pressure of both units must be considered.

Use only refrigerant grade (dehydrated and sealed) copper tubing to connect the condensing unit with the indoor evaporator. After cutting the tubing, install plugs to keep refrigerant tubing clean and dry prior to and during installation. Tubing should always be cut square keeping ends round and free from burrs. Clean the tubing to prevent contamination.

Do NOT let refrigerant lines come in direct contact with plumbing, ductwork, floor joists, wall studs, floors, and walls. When running refrigerant lines through a foundation or wall, openings should allow for sound and vibration absorbing material to be placed or installed between tubing and foundation. Any gap between foundation or wall and refrigerant lines should be filled with a pliable silicon-based caulk, RTV or a vibration damping material. Avoid suspending refrigerant tubing from joists and studs with rigid wire or straps that would come in contact with the tubing. Use an insulated or suspension type hanger. Keep both lines separate and always insulate the suction line.

These sizes are suitable for line lengths of 79 feet or less. If a run of more than 79, refer to TP-107 Long Line Set Application Guideline or contact your distributor for assistance.

This unit is a partial unit air conditioner, complying with partial unit requirements of this international standard, and must be only connected to other units that have been confirmed as complying to corresponding partial unit requirements of this international standard (UL 60335-2-40).

Insulation is necessary to prevent condensation from forming and dropping from the suction line. Armflex (or satisfactory equivalent) with 3/8" min. wall thickness is recommended. In severe conditions (hot, high humidity areas) 1/2" insulation

may be required. Insulation must be installed in a manner which protects tubing from damage and contamination.

EXISTING LINE SETS

Where possible, drain as much residual compressor oil from existing systems, lines, and traps; pay close attention to low areas where oil may collect. Use of an approved flushing agent is recommended followed by a nitrogen purge to remove any remaining flushing agent from the lines or indoor coil. Replacement of indoor coil is recommended.

NOTE: If using existing indoor coil and changing refrigerant types, ensure the indoor coil and metering device are compatible with the type of refrigerant being used. If new indoor coil is required check spec sheet or AHRI for approved coil. If system is being replaced due to compressor electrical failure, assume acid is in system. Refer to Service Procedure S-115 Compressor Burnout in service manual for clean-up procedure.

RECOMMENDED INTERCONNECTING TUBING (Ft)						
Cond Unit Tons	0-24		25-49		50-79*	
	Line Diameter (In. OD)					
	Suct	Liq	Suct	Liq	Suct	Liq
1 1/2	5/8	1/4	3/4	3/8	3/4	3/8
2	5/8	1/4	3/4	3/8	3/4	3/8
2 1/2	5/8	1/4	3/4	3/8	7/8	3/8
3	3/4	3/8	7/8	3/8	1 1/8	3/8
3 1/2	7/8	3/8	1 1/8	3/8	1 1/8	3/8
4	7/8	3/8	1 1/8	3/8	1 1/8	3/8
5	7/8	3/8	1 1/8	3/8	1 1/8	3/8

* Lines greater than 79 feet in length or vertical elevation changes more than 50 feet refer to the TP-107 R-410A Long Line Set Application Guidelines or contact your distributor for assistance.

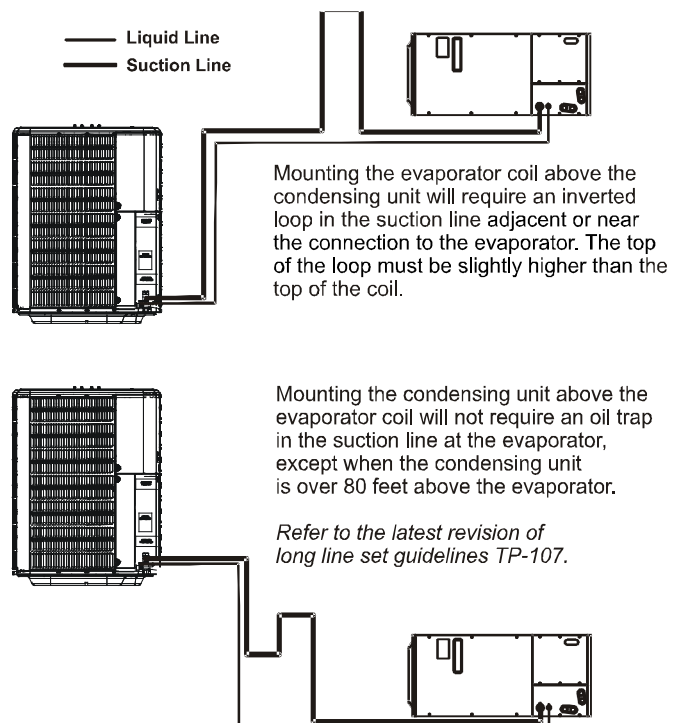

BURYING REFRIGERANT LINES

If burying refrigerant lines can not be avoided, use the following checklist.

1. Insulate liquid and suction lines separately.
2. Enclose all underground portions of the refrigerant lines in waterproof material (conduit or pipe) sealing the ends where tubing enters/exits the enclosure.
3. If the lines must pass under or through a concrete slab, ensure lines are adequately protected and sealed.

REFRIGERANT LINE CONNECTIONS

IMPORTANT

To avoid overheating the service valve, TXV valve, or filter drier while brazing, wrap the component with a wet rag, or use a thermal heat trap compound. Be sure to follow the manufacturer's instruction when using the heat trap compound. Note: Remove Schrader valves from service valves before brazing tubes to the valves. Use a brazing alloy of 2% minimum silver content. Do not use flux.

Torch heat required to braze tubes of various sizes is proportional to the size of the tube. Tubes of smaller size require less heat to bring the tube to brazing temperature before adding brazing alloy. Applying too much heat to any tube can melt the tube. Service personnel must use the appropriate heat level for the size of the tube being brazed. NOTE: The use of a heat shield when brazing is recommended to avoid burning the serial plate or the finish on the unit.

1. The ends of the refrigerant lines must be cut square, deburred, cleaned, and be round and free from nicks or dents. Any other condition increases the chance of a refrigerant leak.
2. "Sweep" the refrigerant line with nitrogen or inert gas during brazing to prevent the formation of copper-oxide inside the refrigerant lines. The POE oils used in R-410A applications will clean any copper-oxide present from the inside of the refrigerant lines and spread it throughout the system. This may cause a blockage or failure of the metering device.
3. After brazing, quench the joints with water or a wet cloth to prevent overheating of the service valve.
4. Ensure the filter drier paint finish is intact after brazing. If the paint of the steel filter drier has been burned or chipped, repaint or treat with a rust preventative. This is especially important on suction line filter driers which are continually wet when the unit is operating.

NOTE: Be careful not to kink or dent refrigerant lines. Kinked or dented lines will cause poor performance or compressor damage.

Do NOT make final refrigerant line connection until plugs are removed from refrigerant tubing.

NOTE: Before brazing, verify indoor TXV is correct for R410A and proper size.

STANDING PRESSURE TEST (RECOMMENDED BEFORE SYSTEM EVACUATION)



WARNING

TO AVOID THE RISK OF FIRE OR EXPLOSION, NEVER USE OXYGEN, HIGH PRESSURE AIR OR FLAMMABLE GASES FOR LEAK TESTING OF A REFRIGERATION SYSTEM.



WARNING

TO AVOID POSSIBLE EXPLOSION, THE LINE FROM THE NITROGEN CYLINDER MUST INCLUDE A PRESSURE REGULATOR AND A PRESSURE RELIEF VALVE. THE PRESSURE RELIEF VALVE MUST BE SET TO OPEN AT NO MORE THAN 450 PSIG.

Using dry nitrogen, pressurize the system to 450 PSIG. Allow the pressure to stabilize and hold for 15 minutes (minimum). If the pressure does not drop below 450 PSIG the system is considered leak free. Proceed to system evacuation using the Deep Vacuum Method. If after 15 minutes the pressure drops below 450 PSIG follow the procedure outlined below to identify system leaks. Repeat the Standing Pressure Test.

LEAK TESTING (NITROGEN OR NITROGEN-TRACED)



WARNING

TO AVOID THE RISK OF FIRE OR EXPLOSION, NEVER USE OXYGEN, HIGH PRESSURE AIR OR FLAMMABLE GASES FOR LEAK TESTING OF A REFRIGERATION SYSTEM.



WARNING

TO AVOID POSSIBLE EXPLOSION, THE LINE FROM THE NITROGEN CYLINDER MUST INCLUDE A PRESSURE REGULATOR AND A PRESSURE RELIEF VALVE. THE PRESSURE RELIEF VALVE MUST BE SET TO OPEN AT NO MORE THAN 450 PSIG.

Leak test the system using dry nitrogen and soapy water to identify leaks. If you prefer to use an electronic leak detector, charge the system to 10 PSIG with the appropriate system refrigerant (See Serial Data Plate for refrigerant identification). Do not use an alternative refrigerant. Using dry nitrogen finish charging the system to 450 PSIG. Apply the leak detector to all suspect areas. When leaks are discovered, repair the leaks, and repeat the pressure test. If leaks have been eliminated proceed to system evacuation.

SYSTEM EVACUATION

Condensing unit liquid and suction valves are closed to contain the charge within the unit. The unit is shipped with the valve stems closed and caps installed. Do not open valves until the system is evacuated.



WARNING

REFRIGERANT UNDER PRESSURE!
FAILURE TO FOLLOW PROPER PROCEDURES MAY CAUSE PROPERTY DAMAGE, PERSONAL INJURY OR DEATH.

NOTE: SCROLL COMPRESSORS SHOULD NEVER BE USED TO EVACUATE OR PUMP DOWN A HEAT PUMP OR AIR CONDITIONING SYSTEM.

 CAUTION
<p>PROLONGED OPERATION AT SUCTION PRESSURES LESS THAN 20 PSIG FOR MORE THAN 5 SECONDS WILL RESULT IN OVERHEATING OF THE SCROLLS AND PERMANENT DAMAGE TO THE SCROLL TIPS, DRIVE BEARINGS AND INTERNAL SEAL.</p>

DEEP VACUUM METHOD (RECOMMENDED)



The Deep Vacuum Method requires a vacuum pump rated for 500 microns or less. This method is an effective and efficient way of assuring the system is free of non-condensable air and moisture. As an alternative, the Triple Evacuation Method is detailed in the Service Manual for this product model.

It is recommended to remove the Schrader Cores from the service valves using a core-removal tool to expedite the evacuation procedure.

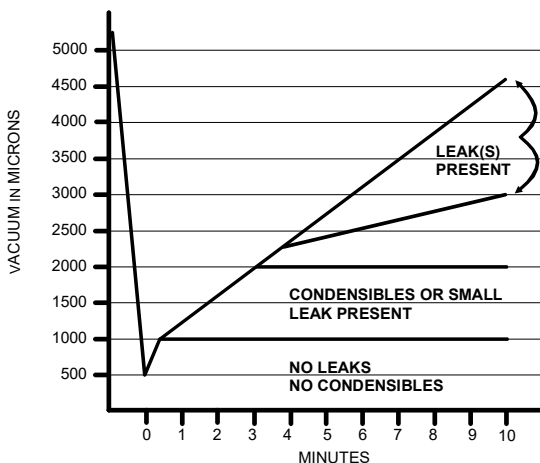
1. Connect the vacuum pump, micron gauge, and vacuum rated hoses to both service valves. Evacuation must use both service valves to eliminate system mechanical seals.
2. Evacuate the system to less than 500 microns.
3. Isolate the pump from the system and hold vacuum for 10 minutes (minimum). Typically, pressure will rise slowly during this period. If the pressure rises to less than 1000 microns and remains steady, the system is considered leak-free; proceed to system charging and startup.
4. If pressure rises above 1000 microns but holds steady below 2000 microns, non-condensable air or moisture may remain or a small leak is present. Return to step 2: If the same result is achieved check for leaks and repair. Repeat the evacuation procedure.
5. If pressure rises above 2000 microns, a leak is present. Check for leaks and repair. Repeat the evacuation procedure.



ELECTRICAL CONNECTIONS

 WARNING	
<p>HIGH VOLTAGE DISCONNECT ALL POWER BEFORE SERVICING. MULTIPLE POWER SOURCES MAY BE PRESENT. FAILURE TO DO SO MAY CAUSE PROPERTY DAMAGE, PERSONAL INJURY OR DEATH DUE TO ELECTRIC SHOCK. WIRING MUST CONFORM WITH NEC OR CEC AND ALL LOCAL CODES. UNDERSIZED WIRES COULD CAUSE POOR EQUIPMENT PERFORMANCE, EQUIPMENT DAMAGE OR FIRE.</p>	

 WARNING
<p>TO AVOID THE RISK OF FIRE OR EQUIPMENT DAMAGE, USE COPPER CONDUCTORS.</p>

NOTICE
<p>UNITS WIL RECIPROCATING OR ROTARY COMPRESSORS AND NON-BLEED TXV'S REQUIRE A HARD START KIT.</p>

The condensing unit rating plate lists pertinent electrical data necessary for proper electrical service and overcurrent protection. Wires should be sized to limit voltage drop to 2% (max.) from the main breaker or fuse panel to the condensing unit. Consult the NEC, CEC, and all local codes to determine the correct wire gauge and length. The appliance shall be installed in accordance with national wiring regulations (UL 60335-2-40). The electrical interfaces shall be specified with safety class of construction.

Local codes often require a disconnect switch located near the unit; do not install the switch on the unit. Refer to the installation instructions supplied with the indoor furnace/air handler for specific wiring connections and indoor unit configuration. Likewise, consult the instructions packaged with the thermostat for mounting and location information.

OVERCURRENT PROTECTION

The following overcurrent protection devices are approved for use.

- Time delay fuses
- HACR type circuit breakers

These devices have sufficient time delay to permit the motor-compressor to start and accelerate its load.

HIGH VOLTAGE CONNECTIONS

Route power supply and ground wires through the high voltage port and terminate in accordance with the wiring diagram provided inside the control panel cover.

LOW VOLTAGE CONNECTIONS

Condensing unit control wiring requires a nominal 24 VAC (+/- 6 VAC), 60 Hz, minimum 25 VA service from either the indoor or optional outdoor transformer. Low voltage wiring for the condensing units depends on the thermostat used. The unit is designed to work as part of a fully communicating

HVAC system utilizing the ComfortBridge compatible indoor unit, and up to four wires. The unit also has legacy 24 VAC inputs and outputs to support non-communicating systems. Route control wires through the low voltage port and terminate in accordance with the wiring diagram provided inside the control panel cover.

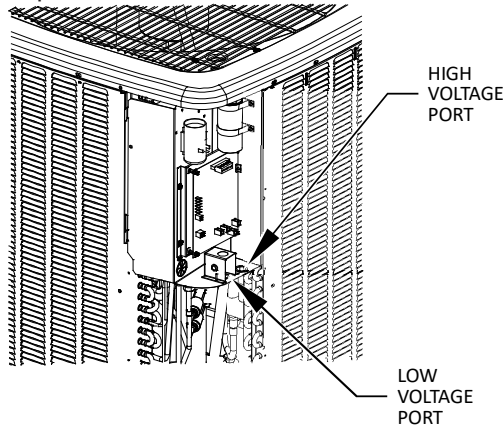

Voltage Ports

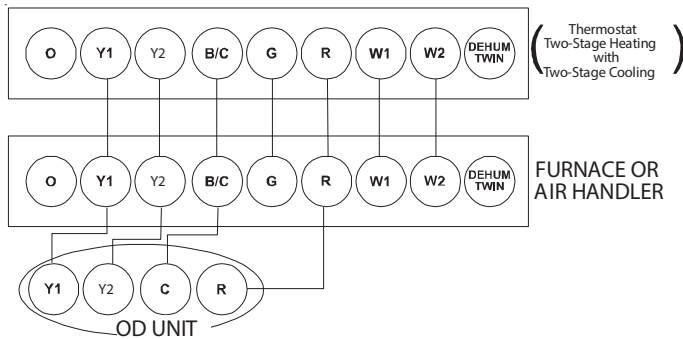

Two-Stage Non-Communicating Thermostat
Low Voltage Wire Connection (legacy mode)

SYSTEM START UP

	WARNING
<p>HIGH VOLTAGE! DISCONNECT ALL POWER BEFORE SERVICING OR INSTALLING THIS UNIT. MULTIPLE POWER SOURCES MAY BE PRESENT. FAILURE TO DO SO MAY CAUSE PROPERTY DAMAGE, PERSONAL INJURY OR DEATH.</p>	

	CAUTION
<p>POSSIBLE REFRIGERANT LEAK TO AVOID A POSSIBLE REFRIGERANT LEAK, OPEN THE SERVICE VALVES UNTIL THE TOP OF THE STEM IS 1/8" FROM THE RETAINER.</p>	

NOTE: Power must be supplied to the 18 SEER & 17.2 SEER2 outdoor units containing ECM motors before the power is applied to the indoor unit. Sending a low voltage signal without high voltage power present at the outdoor unit can cause malfunction of the control module on the ECM motor.

Adequate refrigerant charge for the matching evaporator coil or air handler and 15 feet of lineset is supplied with the condensing unit. If using evaporator coils or air handlers

other than HSVTC coil it maybe necessary to add or remove refrigerant to attain proper charge. If line set exceeds 15 feet in length, refrigerant should be added at .6 ounces per foot of liquid line.

NOTE: Charge should always be checked using superheat when using a piston and subcooling when using TXV equipped indoor coil to verify proper charge.

	CAUTION
<p>POSSIBLE REFRIGERANT LEAK TO AVOID A POSSIBLE REFRIGERANT LEAK, OPEN THE SERVICE VALVES UNTIL THE TOP OF THE STEM IS 1/8" FROM THE RETAINER.</p>	

When opening valves with retainers, open each valve only until the top of the stem is 1/8" from the retainer. To avoid loss of refrigerant, DO NOT apply pressure to the retainer. When opening valves without a retainer remove service valve cap and insert a hex wrench into the valve stem and back out the stem by turning the hex wrench counterclockwise. Open the valve until it contacts the rolled lip of the valve body.

NOTE: These are not back-seating valves. It is not necessary to force the stem tightly against the rolled lip.

Break vacuum by fully opening liquid service valve. After the refrigerant charge has bled into the system, open the suction service valve. The service valve cap is the secondary seal for the valve and must be properly tightened to prevent leaks. Make sure cap is clean and apply refrigerant oil to threads and sealing surface on inside of cap. Tighten cap finger-tight and then tighten additional 1/6 of a turn (1 wrench flat), or to the following specification, to properly seat the sealing surfaces.

1. 3/8" valve to 5 - 10 in-lbs
2. 5/8" valve to 5 - 20 in-lbs
3. 3/4" valve to 5 - 20 in-lbs
4. 7/8" valve to 5 - 20 in-lbs

Do not introduce liquid refrigerant from the cylinder into the crankcase of the compressor as this may damage the compressor.

1. Break vacuum by fully opening liquid and suction base valves.
2. Set thermostat to call for cooling. Check indoor and outdoor fan operation and allow system to stabilize for 20 minutes for expansion valves.

CHARGE VERIFICATION

	WARNING
<p>REFRIGERANT UNDER PRESSURE!</p> <ul style="list-style-type: none"> • DO NOT OVERCHARGE SYSTEM WITH REFRIGERANT. • DO NOT OPERATE UNIT IN A VACUUM OR AT A NEGATIVE PRESSURE. <p>FAILURE TO FOLLOW PROPER PROCEDURES MAY CAUSE PROPERTY DAMAGE, PERSONAL INJURY OR DEATH.</p>	

	WARNING
<p>USE REFRIGERANT CERTIFIED TO AHRI STANDARDS. USED REFRIGERANT MAY CAUSE COMPRESSOR DAMAGE. MOST PORTABLE MACHINES CANNOT CLEAN REFRIGERANT TO MEET AHRI STANDARDS.</p>	



WARNING

VIOLATION OF EPA REGULATIONS MAY RESULT IN FINES OR OTHER PENALTIES.



CAUTION

DAMAGE TO THE UNIT CAUSED BY OPERATING THE COMPRESSOR WITH THE SUCTION VALVE CLOSED IS NOT COVERED BY THE WARRANTY AND MAY CAUSE SERIOUS COMPRESSOR DAMAGE.

FINAL CHARGE ADJUSTMENT

Airflow and Total Static Pressure for the indoor unit should be verified before attempting to charge system.

1. Total static pressure is .5" WC or less.
2. Airflow is correct for installed unit.
3. Airflow tables are in the installation manual and Spec Sheet for Indoor Unit.
4. Complete charging information is in Service Manual RS6200006. Instructions on charging of refrigerants when addition of charge is required by the manufacturer for completing the refrigerant system.

NOTE: Superheat adjustments should not be made until indoor ambient conditions have stabilized. This could take up to 24 hours depending on indoor temperature and humidity. Before checking superheat run the unit in cooling for 10-15 minutes or until refrigerant pressures stabilize. Use the following guidelines and methods to check unit operation and ensure that the refrigerant charge is within limits.

The outdoor temperature must be 60°F or higher. Set the room thermostat to COOL, fan switch to AUTO, and set the temperature control well below room temperature.

Units matched with indoor coils equipped with a non-adjustable TXV should be charged by Subcooling only. Superheat on indoor coils with adjustable TXV valves are factory set and no adjustment is normally required during startup. Only in unique applications due to refrigerant line length, differences in height between the indoor and outdoor unit and refrigerant tubing sizes or poor performance should Superheat setting require adjustment. These adjustments should only be performed by qualified service personnel. For detailed charge and TXV adjustments refer to the appropriate Service Manual.

Instructions on charging of refrigerants when addition of charge is required by the manufacturer for completing the refrigerant system.



CAUTION

TO PREVENT PERSONAL INJURY, CAREFULLY CONNECT AND DISCONNECT MANIFOLD GAUGE HOSES. ESCAPING LIQUID REFRIGERANT CAN CAUSE BURNS. DO NOT VENT REFRIGERANT INTO THE ATMOSPHERE. RECOVER ALL REFRIGERANT DURING SYSTEM REPAIR AND BEFORE FINAL UNIT DISPOSAL.

EXPANSION VALVE SYSTEM

NOTE: Units matched with indoor coils equipped with non-adjustable TXV should be charged by subcooling only.

SUBCOOLING FORMULA = SATURATED LIQUID LINE TEMPERATURE –LIQUID LINE TEMPERATURE

Run the outdoor unit in high stage cooling mode for 10 minutes until refrigerant pressures stabilize. Use the following guidelines and methods to check unit operation and ensure that the refrigerant charge is within limits.

NOTE: Charge the unit on low stage.

1. Purge the gauge lines and connect the service gauge manifold to the base valve service ports.
2. Clamp a pipe clamp thermometer on the liquid line near the liquid line service valve and 4-6" from the compressor on the suction line.
 - a. Ensure the thermometer makes adequate contact to obtain the best possible readings.
 - b. The temperature read with the thermometer should be lower than the saturated condensing temperature.
3. The difference between the measured saturated condensing temperature and the liquid line temperature is the liquid Subcooling value.
4. TXV-based systems should have a Subcooling value of 6°F +/- 1°F. For GSXC706010 or ASXC706010, systems should have a Subcooling value of 8°F +/- 1°F.
5. Add refrigerant to increase Subcooling and remove refrigerant to decrease Subcooling.

NOTE: Units matched with indoor coils equipped with a TXV should be charged by Subcooling only. Superheat can also be utilized to best verify charge levels with an adjustable TXV and make adjustments when needed in unique applications due to refrigerant line length, differences in height between the indoor and outdoor unit and refrigerant tubing sizes. These adjustments should only be performed by qualified service personnel.

ADVANCE ADJUSTMENT RECOMMENDATIONS

SUPERHEAT FORMULA = SUCTION LINE TEMPERATURE - SATURATED SUCTION TEMPERATURE

1. Clamp a pipe clamp thermometer near the suction line service valve at the outdoor unit.
 - a. Ensure the thermometer makes adequate contact for the best possible readings.
 - b. The temperature read with the thermometer should be higher than the saturated suction temperature.
2. The difference between the measured saturated suction temperature and the suction line temperature is the Superheat value.
3. TXV-based systems should have a Superheat value of 8°F +/- 1°F.
4. Adjust Superheat by turning the TXV valve stem clockwise to increase and counterclockwise to decrease.

- a. If Subcooling and Superheat are low, adjust the TXV to 8°F +/- 1°F, and then check Subcooling.
- b. If Subcooling is low and Superheat is high, add charge to raise Subcooling to 6°F +/- 1°F then check Superheat. For GSXC706010 or ASXC706010, systems should have a Subcooling value of 8°F +/- 1°F.
- c. If Subcooling and Superheat are high, adjust the TXV valve to 8°F +/- 1°F Superheat, then check the Subcooling value.
- d. If subcooling is high and Superheat is low, adjust the TXV valve to 8°F +/- 1°F Superheat and remove charge to lower the Subcooling to 6°F +/- 1°F. For GSXC706010 or ASXC706010, systems should have a Subcooling value of 8°F +/- 1°F.

NOTE: DO NOT adjust the charge based exclusively on suction pressure unless for general charging in the case of a gross undercharge.

NOTE: Check the Schrader ports for leaks and tighten valve cores if necessary. Install caps finger-tight.

System	System Operating Mode	Airflow Dem and Source
Air Conditioner + Air Handler	Cooling	Air Conditioner
	Heating	Air Handler
	Continuous Fan	Thermostat
Air Conditioner + Furnace	Cooling	Air Conditioner
	Heating	Furnace
	Continuous Fan	Thermostat

SATURATED SUCTION PRESSURE TEMPERATURE CHART	
SUCTION PRESSURE	SATURATED SUCTION TEMPERATURE °F
PSIG	R-410A
50	1
52	3
54	4
56	6
58	7
60	8
62	10
64	11
66	13
68	14
70	15
72	16
74	17
76	19
78	20
80	21
85	24
90	26
95	29
100	31
110	36
120	41
130	45
140	49
150	53
160	56
170	60

SATURATED LIQUID PRESSURE TEMPERATURE CHART	
LIQUID PRESSURE	SATURATED LIQUID TEMPERATURE °F
PSIG	R-410A
200	70
210	73
220	76
225	78
235	80
245	83
255	85
265	88
275	90
285	92
295	95
305	97
325	101
355	108
375	112
405	118
415	119
425	121
435	123
445	125
475	130
500	134
525	138
550	142
575	145
600	149
625	152

ADDITIONAL NOTES

1. There are (3) 7-segment LED displays on the PCB. See the Troubleshooting Tables at the end of this manual for definitions of the LED status.
2. When system is at Standby mode, press “TEST” push button to turn on both compressor and outdoor fan for five (5) seconds.
3. Press “RECALL” push-button to retrieve the six most recent faults. The control must be in Standby Mode (no thermostat inputs) to use the feature. Depress the push-button for approximately two seconds and less than five seconds. The (3) 7-segment LED displays will then display the six most recent faults beginning with the most recent fault and decrementing to the least recent fault. The faults may be cleared by depressing the button for greater than five seconds. Consecutively repeated faults are displayed a maximum of three times. Refer to the fault code definitions at the end of this manual for more details.
4. “TERM” dipswitch is used for communications bus configuration. Leave the settings to the factory default position.
5. “LEARN” push button is used to reset the communications between the equipment. Used only for troubleshooting purposes.

COMFORTBRIDGE™ SYSTEM

OVERVIEW

The **ComfortBridge** based two stage heating and air conditioning system uses an indoor unit and outdoor unit digitally communicating with one another via a two-way communications path.

In a traditional system, the thermostat sends commands to the indoor and outdoor units via analog 24 VAC signals. It is a one-way communication path in that the indoor and outdoor units typically do not return information to the thermostat.

The indoor unit, and outdoor unit, comprising of a **ComfortBridge** system “communicate” digitally with one another creating a two-way communications path. The thermostat still sends commands to the indoor unit, however, the 24VAC indoor and outdoor unit may also request and receive information from one another to optimize system performance.

Two-way digital communications is accomplished using only two wires. The thermostat and subsystem controls are powered with 24 VAC. Thus, a maximum of 4 wires between the equipment and thermostat is all that is required to operate the system.

AIRFLOW CONSIDERATION

Airflow demands are managed differently in a fully communicating system than they are in a legacy wired system. The system operating mode (as determined by the thermostat) determines which unit calculates the system airflow demand. If the indoor unit is responsible for determining the airflow demand, it calculates the demand and sends it to the ECM motor. If the outdoor unit or thermostat is responsible for de-

termining the demand, it calculates the demand and transmits the demand along with a fan request to the indoor unit. The indoor unit then sends the demand to the ECM motor. The following table lists the various ComfortBridge compatible systems, the operating mode, and airflow demand source.

For example, assume the system is an air conditioner matched with an air handler. With a call for low stage cooling, the air conditioner will calculate the system’s low stage cooling airflow demand. The air conditioner will then send a fan request along with the low stage cooling airflow demand to the air handler. Once received, the air handler will send the low stage cooling airflow demand to the ECM motor. The ECM motor then delivers the low stage cooling airflow. The following table lists the nominal high and low stage airflow for the ComfortBridge air conditioners.

Model	High	Low
*SXC160241	800	600
*SXC160361	1200	800
*SXC160481	1550	1100
*SXC160601	1800	1400

*SXC180241	800	600
*SXC180361	1250	850
*SXC180481	1550	1070
*SXC180601	1750	1210

*SXC702410	800	600
*SXC703610	1250	850
*SXC704810	1550	1070
*SXC706010	1750	1210

CONTROL WIRING

NOTE: Refer to Electrical Connections - High Voltage Connections for 208/230 volt line connections to the air conditioner.

NOTE: A removable plug connector is provided with the control to make thermostat wire connections. This plug may be removed, wire connections made to the plug, and replaced. It is strongly recommended that multiple wires into a single terminal be twisted together prior to inserting into the plug connector. Failure to do so may result in intermittent operation.

Typical 18 AWG thermostat wire may be used to wire the system components. However, communications reliability may be improved by using a high quality, shielded, twisted pair cable for the data transmission lines. In either case, 150 feet is the recommended length of wire between indoor unit and outdoor unit, or between indoor unit and thermostat.

Only data lines 1 and 2 are required between the indoor and outdoor units. A 40VA, 208/230 VAC to 24 VAC transformer is factory installed in the outdoor unit to provide 24 VAC power to the outdoor unit’s electronic control.

NOTE: Use of a 40VA transformer is recommended for units without factory installed transformers using multi-stage equipment. Failure to use the transformer in the outdoor unit could result in overloading of the indoor transformer.

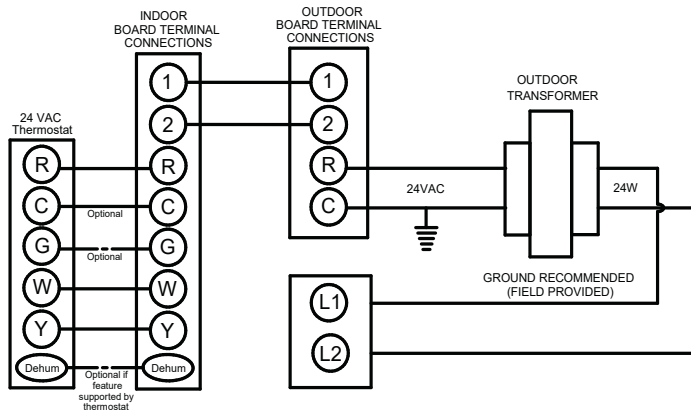

COMFORTBRIDGE™ SYSTEM ADVANCED FEATURES

The ComfortBridge system permits access to additional system information, advanced set-up features, and advanced diagnostic/troubleshooting features via the control board push buttons or the CoolCloud mobile app.

FAULT CODE HISTORY

Accessing the air conditioner/heat pump's diagnostics menu provides ready access to the last six faults detected by the air conditioner/heat pump. Faults are stored most recent to least recent. Any consecutively repeated fault is stored a maximum of three times. Example: The power supply to the air conditioner/heat pump is continuously below 187 VAC. The control will only store this fault the first three consecutive times the fault occurs.

NOTE: It is highly recommended that the fault history be cleared after performing maintenance or servicing the heat pump.

CONFIGURATION INFO

Model Number, Serial Number and Software Version are displayed within this menu. A model number check will help determine if the equipment shared data is correct for the unit. If the model number is not correct or no serial number is visible, even though very rare, memory cards are available to load the proper data.

SENSOR DATA

The outdoor ambient temperature and coil temperature are displayed in the Sensor Data Menu. This information can be used for troubleshooting purposes.

DEVICE SETTINGS

This menu allows for the adjustment of several cooling performance variables. Cool Airflow Trim (range from -10% to 10% in 2% increments), Cool Airflow Profiles, Cool Fan ON Delay, Cool Fan OFF Delay and Dehumidification Select (enable or

disable dehumidification) can be adjusted in this menu. See the following images showing the four cooling airflow profiles.

- Profile A** (default) provides only an OFF delay of one (1) minute at 100% of the cooling demand airflow.

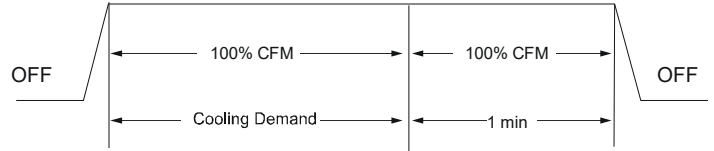

- Profile B** ramps up to full cooling demand airflow by first stepping up to 50% of the full demand for 30 seconds. The motor then ramps to 100% of the required airflow. A one (1) minute OFF delay at 100% of the cooling airflow.

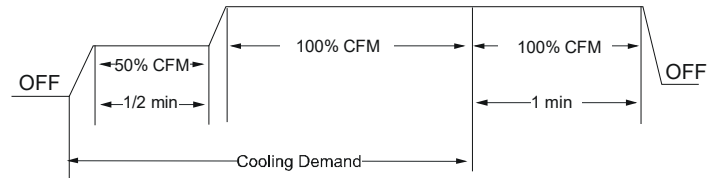

- Profile C** ramps up to 82% of the full cooling demand airflow and operates there for approximately 7 1/2 minutes. The motor then steps up to the full demand airflow. Profile C also has a one (1) minute 100% OFF delay.

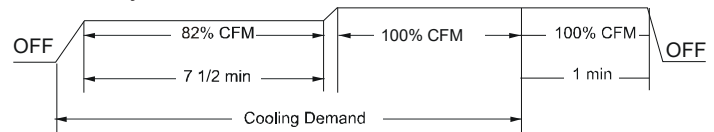

- Profile D** ramps up to 50% of the demand for 1/2 minute, then ramps to 82% of the full cooling demand airflow and operates there for approximately 7 1/2 minutes. The motor then steps up to the full demand airflow. Profile D has a 1/2 minute at 50% airflow OFF delay.

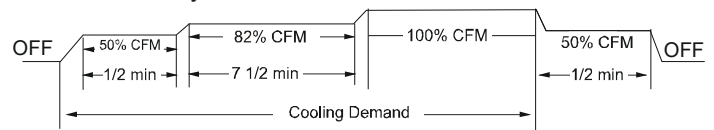

Airflow Tables

DEVICE STATUS

The current system operational mode and requested indoor CFM is reported in this menu. This information can be used for troubleshooting purposes.

SYSTEM TROUBLESHOOTING

NOTE: Refer to the instructions accompanying the CT compatible indoor air handler/furnace/modular blower unit for troubleshooting information regarding indoor unit diagnostics..

Refer to the Troubleshooting Chart at the end of this manual for a listing of possible air conditioner and heat pump error codes, possible causes and corrective actions.

AIR CONDITIONER/HEAT PUMP ADVANCED FEATURES MENU

DIAGNOSTICS		
Submenu Item	Indication/User Modifiable Options	Comments
Fault 1 (FAULT #1)	Most recent AC/HP fault	For display only
Fault 2 (FAULT #2)	Next most recent AC/HP fault	For display only
Fault 3 (FAULT #3)	Next most recent AC/HP fault	For display only
Fault 4 (FAULT #4)	Next most recent AC/HP fault	For display only
Fault 5 (FAULT #5)	Next most recent AC/HP fault	For display only
Fault 6 (FAULT #6)	Least recent AC/HP fault	For display only
Clear Fault History (CLEAR)	NO or YES	Selecting "YES" clears the fault history

NOTE: Consecutively repeated faults are shown a maximum of 3 times

IDENTIFICATION	
Submenu Item	Indication (for Display Only; not User Modifiable)
Model Number (MOD NUM)	Displays the air conditioner or heat pump model number
Serial Number (SER NUM)	Displays the air conditioner or heat pump serial number (Optional)
Software (SOFTWARE)	Displays the application software revision

SENSORS		
Submenu Item	User Modifiable Options	Comments
Outdoor Air Temperature (AIR TMP)	Displays the outdoor air temperature	Sensor may or may not be available on an air conditioner. Check air conditioner instructions for details.

COOL SET-UP		
Submenu Item	User Modifiable Options	Comments
Cool Airflow Trim (CL TRM)	-10% to +10% in 2% increments, default is 0%	Selects the airflow trim amount; applies to air conditioner only.
Cool Airflow Profile (CL PRFL)	A, B, C, or D, default is A	Selects the airflow profile; applies to air conditioner only.
Cool ON Delay (CL ON)	5, 10, 20, or 30 seconds, default is 5 seconds	Selects the indoor blower ON delay; applies to air conditioner only.
Cool OFF Delay (CL OFF)	30, 60, 90, or 120 seconds, default is 30 seconds	Selects the indoor blower OFF delay; applies to air conditioner only.
Dehumidification Select (DEHUM)	ON or OFF (default is OFF)	Selecting "OFF" disables dehumidification; selecting "ON" enables dehumidification; applies to air conditioner only.

STATUS	
Submenu Item	Indication (for Display Only; not User Modifiable)
Mode (MODE)	Displays the current air conditioner operating mode
CFM (CFM)	Displays the airflow for the current operating mode

SYSTEM TROUBLESHOOTING

NOTE: Refer to the instructions accompanying the ComfortBridge compatible indoor air handler/furnace/modular blower unit for troubleshooting information.

Refer to the Troubleshooting Chart at the end of this manual for a listing of possible air conditioner and heat pump error codes, possible causes and corrective actions.

UNIT TROUBLESHOOTING INFORMATION

Complaint	No Cooling							Unsatisfactory Cooling/Heating							System Operating Pressures				Test Method Remedy	
	SYMPTOM	System will not start	Compressor will not start - fan runs	Comp. and Cond. Fan will not start	Evaporator fan will not start	Condenser fan will not start	Compressor runs - goes off on overload	Compressor cycles on overload	System runs continuously - little cooling/htg	Too cool and then too warm	Not cool enough on warm days	Certain areas too cool, others too warm	Compressor is noisy	System runs - blows cold air in heating	Unit will not terminate defrost	Unit will not defrost	Low suction pressure	Low head pressure		High suction pressure
Power Failure	●																			Test Voltage
Blown Fuse	●		●	●																Inspect Fuse Size & Type
Unbalanced Power, 3PH		●					●	●												Test Voltage
Loose Connection	●			●			●													Inspect Connection - Tighten
Shorted or Broken Wires	●	●	●	●	●	●	●													Test Circuits With Ohmmeter
Open Fan Overload				●	●															Test Continuity of Overload
Faulty Thermostat	●		●	●				●												Test Continuity of Thermostat & Wiring
Faulty Transformer	●		●																	Check Control Circuit with Voltmeter
Shorted or Open Capacitor		●		●	●	●	●													Test Capacitor
Internal Compressor Overload Open		●											◆							Test Continuity of Overload
Shorted or Grounded Compressor		●				●														Test Motor Windings
Compressor Stuck		●				●	●						◆							Use Test Cord
Faulty Compressor Contactor			●		●	●														Test Continuity of Coil & Contacts
Faulty Fan Relay				●																Test Continuity of Coil And Contacts
Open Control Circuit				●																Test Control Circuit with Voltmeter
Low Voltage		●				●	●													Test Voltage
Faulty Evap. Fan Motor				●												●		◆		Repair or Replace
Shorted or Grounded Fan Motor					●														●	Test Motor Windings
Improper Cooling Anticipator							●	●												Check Resistance of Anticipator
Shortage of Refrigerant							●	●					◆			●	●			Test For Leaks, Add Refrigerant
Restricted Liquid Line							●	●								●	●	●		Remove Restriction, Replace Restricted Part
Open Element or Limit on Elec. Heater								◆					◆							Test Heater Element and Controls
Dirty Air Filter							●	●	●	●						●			◆	Inspect Filter-Clean or Replace
Dirty Indoor Coil							●	●	●							●			◆	Inspect Coil - Clean
Not enough air across Indoor Coil							●	●	●							●			◆	Check Blower Speed, Duct Static Press, Filter
Too much air across Indoor Coil																	◆	●		Reduce Blower Speed
Overcharge of Refrigerant						●	●				●	◆				●		●		Recover Part of Charge
Dirty Outdoor Coil					●	●		●								◆			●	Inspect Coil - Clean
Noncondensibles							●	●					◆						●	Recover Charge, Evacuate, Recharge
Recirculation of Condensing Air							●	●											●	Remove Obstruction to Air Flow
Infiltration of Outdoor Air							●	●	●											Check Windows, Doors, Vent Fans, Etc.
Improperly Located Thermostat					●			●												Relocate Thermostat
Air Flow Unbalanced								●	●											Readjust Air Volume Dampers
System Undersized							●	●												Refigure Cooling Load
Broken Internal Parts												●	◆							Replace Compressor
Broken Valves												●	◆				●	●		Test Compressor Efficiency
Inefficient Compressor								●					◆				●	●		Test Compressor Efficiency
Wrong Type Expansion Valve						●	●	●	●							●	●	◆		Replace Valve
Expansion Device Restricted						●	●	●	●							●	●			Remove Restriction or Replace Expansion Device
Oversized Expansion Valve							●												●	Replace Valve
Undersized Expansion Valve						●	●	●	●							●				Replace Valve
Expansion Valve Bulb Loose												●						●		Tighten Bulb Bracket
Inoperative Expansion Valve					●		●									●				Check Valve Operation
Loose Hold-down Bolts												●								Tighten Bolts
Faulty Reversing Valve					●								◆	◆	◆		◆	◆	◆	Replace Valve or Solenoid
Faulty Defrost Control													◆	◆	◆		◆	◆	◆	Test Control
Faulty Defrost Thermostat													◆	◆	◆		◆	◆	◆	Test Defrost Thermostat
Flowrator Not Seating Properly							●										●	●		Check Flowrator & Seat or Replace Flowrator

● Cooling or Heating Cycle (Heat Pump) ◆ Heating Cycle Only (Heat Pump)

For detailed service information refer to the Remote Condensing Unit Service manual.

<p>NOTICE</p> <p>UNITS W/ RECIPROCATING OR ROTARY COMPRESSORS AND NON-BLEED TXV'S REQUIRE A HARD START KIT.</p>
--

DIAGNOSTIC TABLE

7 SEGMENT LED (DS2)	7 SEGMENT LED (DS1)	DESCRIPTION OF CONDITION
0	n	Standby
0	1	Low Pressure CO Trip
0	1	Low Side Fault
0	2	High Pressure CO Trip
0	2	High Side Fault
0	3	Short Cycling
0	4	Locked Rotor
0	5	Open Circuit
0	6	Open Start Circuit
0	7	Open Run Circuit
0	8	No Line Voltage
0	9	Low Pilot Voltage
8	8	Power Up
A	2	Outdoor Air Temp Sensor Fault
A	3	Outdoor Coil Temp Sensor Fault *
b	0	No Indoor Airflow
b	9	Inadequate Airflow
C	3	Cool Mode Short Cycle Timer
C	1	Low Cool
C	2	High Cool
d	F	Defrost *
d	t	Max Defrost Time *
d	E	Forced Defrost *
d	0	Data not yet on Network
d	1	Invalid Data on Network
d	2	System Mis-Match
d	3	Configuration Mis-Match
d	4	Invalid Memory Card Data
E	E	Board Misoperation
E	5	Open Fuse
F	t	Field Test Mode
H	8	High Line Voltage
L	1	LPCO Lockout (3 Trips)
L	2	HPCO Lockout (3 Trips)
L	6	Open Start Circuit Lockout
L	7	Open Run Circuit Lockout
L	8	Low Line Voltage
P	3	Heat Mode Short Cycle Timer *
P	1	Low Heat *
P	2	High Heat *
P	0	Comp Protector Open

* CODE USED ON HEAT PUMP MODELS ONLY

NOTE 1: DS1, DS2 AND DS3 ARE LABELED ON THE CONTROL ABOVE EACH 7 SEGMENT LED DISPLAY

NOTE 2: 7 SEGMENT LED DISPLAY DS3 IS NOT USED



0140M00407-A

TROUBLESHOOTING INFORMATION: UNITARY DIAGNOSTIC CODES

SYSTEM TROUBLESHOOTING									
UNITARY DIAGNOSTIC CODES									
Symptoms of Abnormal Operation (Legacy & ComfortBridge™ Thermostat)	Diagnostic/Status LED Display Codes			Fault Description	ComfortBridge™ Thermostat Only		Possible Causes	Corrective Actions	Notes & Cautions
	Digit 3	Digit 2	Digit 1		Message	Code			
<ul style="list-style-type: none"> Integrated control module diagnostic/status LED display shows the indicated code. ComfortBridge™ thermostat displays '---' in the temperature display area. 	BLANK	A	2	<ul style="list-style-type: none"> Outdoor air temp sensor fault 	AIR SENSOR FLT	A2	<ul style="list-style-type: none"> Shorted sensor. Open sensor. Sensor disconnected. Sensor out of range. 	<ul style="list-style-type: none"> Check sensor connection. Replace open/shorted sensor. 	<ul style="list-style-type: none"> Turn power OFF prior to repair. Replace with correct replacement part.
<ul style="list-style-type: none"> Heat pump fails to operate in heating mode Integrated control module diagnostic/status LED display shows the indicated code. ComfortBridge™ thermostat displays error message. 	BLANK	A	3	<ul style="list-style-type: none"> Outdoor coil temp sensor fault 	COIL SENSOR FLT	A3	<ul style="list-style-type: none"> Shorted sensor. Open sensor. Sensor disconnected. Sensor out of range. 	<ul style="list-style-type: none"> Check sensor connection. Replace open/shorted sensor. 	<ul style="list-style-type: none"> Turn power OFF prior to repair. Replace with correct replacement part.
<ul style="list-style-type: none"> Air conditioner/heat pump fails to operate Integrated control module diagnostic/status LED display shows the indicated code. 	BLANK	E	5	<ul style="list-style-type: none"> Open fuse 	BLOWN FUSE	E5	<ul style="list-style-type: none"> Short in low voltage wiring. 	<ul style="list-style-type: none"> Locate and correct short in low voltage wiring. 	<ul style="list-style-type: none"> Turn power OFF prior to repair. Replace fuse with 3-amp automotive type.
<ul style="list-style-type: none"> Air conditioner/heat pump fails to operate Integrated control module diagnostic/status LED display shows the indicated code. 	BLANK	E	E	<ul style="list-style-type: none"> Board mis-operation 	INTERNAL FAULT	EE	<ul style="list-style-type: none"> Compressor relay contacts welded. 	<ul style="list-style-type: none"> Replace control. 	<ul style="list-style-type: none"> Turn power OFF prior to repair. Replace with correct replacement part.
<ul style="list-style-type: none"> Air conditioner/heat pump fails to operate Integrated control module diagnostic/status LED display shows the indicated code. ComfortBridge™ thermostat displays error message. 	BLANK	b	0	<ul style="list-style-type: none"> Circulator blower motor is not running when it should be running. 	MOTOR NOT RUN	b0	<ul style="list-style-type: none"> Indoor blower motor problem. Communications error between indoor and outdoor unit. 	<ul style="list-style-type: none"> Check indoor blower motor. Check indoor blower motor wiring. Check indoor unit control. Repair/replace any faulty wiring. Repair/replace indoor blower motor or control. 	<ul style="list-style-type: none"> Turn power OFF prior to repair. Applies only to fully communicating system using ComfortBridge™ thermostat. Replace with correct replacement part.
<ul style="list-style-type: none"> Air conditioner/heat pump operates at reduced performance. Air conditioner/heat pump operating at low stage when expected to operate at high stage. Integrated control module diagnostic/status LED display shows the indicated code. 	BLANK	b	9	<ul style="list-style-type: none"> Airflow is lower than demanded 	LOW ID AIRFLOW	b9	<ul style="list-style-type: none"> Indoor blower motor problem Blocked filters Restrictive/undersized ductwork Indoor/outdoor unit mis-match. 	<ul style="list-style-type: none"> Check indoor blower motor Check filters; clean/replace as needed Check ductwork; resize as needed Verify indoor and outdoor units are properly matched. 	<ul style="list-style-type: none"> Turn power OFF prior to repair. Applies only to fully communicating system using ComfortBridge™ thermostat. Replace with correct replacement part. See specification sheet(s) for airflow requirements and maximum external static pressure. See specification sheets for approved system matches.

TROUBLESHOOTING INFORMATION: UNITARY DIAGNOSTIC CODES

UNITARY DIAGNOSTIC CODES									
Symptoms of Abnormal Operation (Legacy & ComfortBridge™ Thermostat)	Diagnostic/Status LED Display Codes			Fault Description	ComfortBridge™ Thermostat Only		Possible Causes	Corrective Actions	Notes & Cautions
	Digit 3	Digit 2	Digit 1		Message	Code			
<ul style="list-style-type: none"> • Air conditioner/heat pump fails to operate. • Integrated control module diagnostic/status LED display shows the indicated code. • ComfortBridge™ thermostat displays error message. 	BLANK	d	0	<ul style="list-style-type: none"> • Data not yet on Network 	NO NET DATA	d0	<ul style="list-style-type: none"> • Air conditioner/heat pump is wired as part of a communicating system and integrated control module does not contain any shared data. 	<ul style="list-style-type: none"> • Verify system type (communicating or legacy) • Populate shared data using memory card • Wire system as legacy system 	<ul style="list-style-type: none"> • Turn power OFF prior to repair. • Use memory card for your specific model. • Insert memory card BEFORE turning power ON. Memory card may be removed after data is loaded. Turn power OFF before removing memory card. • Error code will be cleared once data is loaded. Applies only to fully communicating system using ComfortBridge™ thermostat.
<ul style="list-style-type: none"> • Air conditioner/heat pump fails to operate. • Integrated control module diagnostic/status LED display shows the indicated code. • ComfortBridge™ thermostat displays error message. 	BLANK	d	1	<ul style="list-style-type: none"> • Invalid Data on Network 	INVALID DATA	d1	<ul style="list-style-type: none"> • Air conditioner/heat pump is wired as part of a communicating system and integrated control module contains invalid shared data or network data is invalid for the integrated control module. 	<ul style="list-style-type: none"> • Verify system type (communicating or legacy) • Populate shared data using memory card • Wire system as legacy system 	<ul style="list-style-type: none"> • Turn power OFF prior to repair. • Use memory card for your specific model. • Insert memory card BEFORE turning power ON. Memory card may be removed after data is loaded. Turn power OFF before removing memory card. • Error code will be cleared once data is loaded. Applies only to fully communicating system using ComfortBridge™ thermostat.
<ul style="list-style-type: none"> • Air conditioner/heat pump fails to operate. • Air conditioner/heat pump operating at a reduced performance. • Air conditioner/heat pump operating at low stage when expected to operate at high stage. • Integrated control module diagnostic/status LED display shows the indicated code. • ComfortBridge™ thermostat displays error message. 	BLANK	d	2	<ul style="list-style-type: none"> • System Mismatch 	INVALID SYSTEM	d2	<ul style="list-style-type: none"> • Air conditioner/heat pump is wired as part of a communicating system and outdoor unit requires airflow greater than indoor unit's airflow capability. • Shared data is incompatible with the system or missing parameters. 	<ul style="list-style-type: none"> • Verify system type (communicating or legacy) • Verify shared data is correct for your specific model; re-populate data if required. • Wire system as legacy system 	<ul style="list-style-type: none"> • Turn power OFF prior to repair. • Use memory card for your specific model. • Insert memory card BEFORE turning power ON. Memory card may be removed after data is loaded. Turn power OFF before removing memory card. • Error code will be cleared once data is loaded. Applies only to fully communicating system using ComfortBridge™ thermostat.

TROUBLESHOOTING INFORMATION: UNITARY DIAGNOSTIC CODES

UNITARY DIAGNOSTIC CODES									
Symptoms of Abnormal Operation (Legacy & ComfortBridge™ Thermostat)	Diagnostic/Status LED Display Codes			Fault Description	ComfortBridge™ Thermostat Only		Possible Causes	Corrective Actions	Notes & Cautions
	Digit 3	Digit 2	Digit 1		Message	Code			
<ul style="list-style-type: none"> Air conditioner/heat pump fails to operate. Integrated control module diagnostic/ status LED display shows the indicated code. ComfortBridge™ thermostat displays error message. 	BLANK	d	3	<ul style="list-style-type: none"> Configuration Mis-match 	INVALID CONFIG	d3	<ul style="list-style-type: none"> Shared data sent to integrated control module does not match hardware configuration. 	<ul style="list-style-type: none"> Verify system type (communicating or legacy). Verify shared data is correct for your specific model; re-populate data if required. Wire system as legacy system. 	<ul style="list-style-type: none"> Turn power OFF prior to repair Use memory card for your specific model. Insert memory card BEFORE turning power ON. Memory card may be removed after data is loaded. Turn power OFF before removing memory card. Error code will be cleared once data is loaded. Applies only to fully communicating system using ComfortBridge™ thermostat.
<ul style="list-style-type: none"> Air conditioner/heat pump fails to operate. Integrated control module diagnostic/ status LED display shows the indicated code. ComfortBridge™ thermostat displays error message. 	BLANK	d	4	<ul style="list-style-type: none"> Invalid Memory Card Data 	INVALID MC DATA	d4	<ul style="list-style-type: none"> Shared data on memory card has been rejected. 	<ul style="list-style-type: none"> Verify system type (communicating or legacy). Verify shared data is correct for your specific model; re-populate data if required. Wire system as legacy system. 	<ul style="list-style-type: none"> Turn power OFF prior to repair Use memory card for your specific model. Insert memory card BEFORE turning power ON. Memory card may be removed after data is loaded. Turn power OFF before removing memory card. Error code will be cleared once data is loaded.
<ul style="list-style-type: none"> Very long run time. Four consecutive compressor protector trips with average run time between trips greater than 3 hours. Compressor operating at high speed and outdoor fan operating at low speed Integrated control module diagnostic/status LED display shows the indicated code. 	BLANK	0	1	<ul style="list-style-type: none"> Low Side Fault 	LOW SIDE FAULT	01	<ul style="list-style-type: none"> Low refrigerant charge. Restriction in liquid line. Indoor blower motor failure. Indoor thermostat set extremely low. 	<ul style="list-style-type: none"> Verify refrigerant charge; adjust as needed. Check for restricted liquid line; repair/replace as needed. Check indoor blower motor; repair/ replace as needed. Check indoor thermostat setting. 	<ul style="list-style-type: none"> Turn power OFF prior to repair Fault will clear after 30 consecutive normal cycles. Fault may be cleared by cycling 24VAC to control. Replace with correct replacement part(s).
<ul style="list-style-type: none"> Compressor and outdoor fan are off. Thermostat demand is present. Integrated control module diagnostic/status LED display shows the indicated code. 	BLANK	0	1	<ul style="list-style-type: none"> Low Pressure Cut Out Trip 	LPS OPEN	01	<ul style="list-style-type: none"> Low refrigerant charge. Restriction in liquid line. Indoor blower motor failure. Indoor thermostat set extremely low. 	<ul style="list-style-type: none"> Verify refrigerant charge; adjust as needed. Check for restricted liquid line; repair/replace as needed. Check indoor blower motor; repair/ replace as needed. Check low pressure switch; repair/replace as needed. Check indoor thermostat setting. 	<ul style="list-style-type: none"> Turn power OFF prior to repair. Replace with correct replacement part(s).

TROUBLESHOOTING INFORMATION: UNITARY DIAGNOSTIC CODES

UNITARY DIAGNOSTIC CODES									
Symptoms of Abnormal Operation (Legacy & ComfortBridge™ Thermostat)	Diagnostic/Status LED Display Codes			Fault Description	ComfortBridge™ Thermostat Only		Possible Causes	Corrective Actions	Notes & Cautions
	Digit 3	Digit 2	Digit 1		Message	Code			
	<ul style="list-style-type: none"> Compressor and outdoor fan are off. Low pressure switch trip 3 times within same thermostat demand. Thermostat demand is present. Integrated control module diagnostic/status LED display shows the indicated code. ComfortBridge™ thermostat displays error message. 	BLANK	L		1	• Low Pressure Cut Out Lockout (3 Trips)			
<ul style="list-style-type: none"> Four consecutive compressor protector trips with average run time between trips greater than 1 minute and less than 15 minutes. Low pressure and high pressure switches are closed. Integrated control module diagnostic/status LED display shows the indicated code. 	BLANK	0	2	• High Side Fault	HIGH SIDE FAULT	02	<ul style="list-style-type: none"> Blocked condenser coil. Outdoor fan not running. 	<ul style="list-style-type: none"> Check and clean condenser coil. Check outdoor fan motor; repair/ replace as needed. Check outdoor fan motor wiring; repair/ replace as needed. Check outdoor fan motor capacitor; replace as needed. 	<ul style="list-style-type: none"> Turn power OFF prior to repair Fault will clear after 4 consecutive normal cycles. Fault may be cleared by cycling 24VAC to control. Replace with correct replacement part(s).
<ul style="list-style-type: none"> Compressor and outdoor fan are off. Thermostat demand is present. Integrated control module diagnostic/status LED display shows the indicated code. 	BLANK	0	2	• High Pressure Cut Out Trip	HPS OPEN	02	<ul style="list-style-type: none"> Blocked condenser coil. Outdoor fan not running. 	<ul style="list-style-type: none"> Check and clean condenser coil. Check outdoor fan motor; repair/ replace as needed. Check outdoor fan motor wiring; repair/ replace as needed. Check outdoor fan motor capacitor; replace as needed. 	<ul style="list-style-type: none"> Turn power OFF prior to repair. Replace with correct replacement part(s).
<ul style="list-style-type: none"> Compressor and outdoor fan are off. Low pressure switch trip 3 times within same thermostat demand. Thermostat demand is present. Integrated control module diagnostic/status LED display shows the indicated code. ComfortBridge™ thermostat displays error message. 	BLANK	L	2	• High Pressure Cut Out Lockout (3 Trips)	HPS LOCKOUT	02	<ul style="list-style-type: none"> Blocked condenser coil. Outdoor fan not running. 	<ul style="list-style-type: none"> Check and clean condenser coil. Check outdoor fan motor; repair/ replace as needed. Check outdoor fan motor wiring; repair/ replace as needed. Check outdoor fan motor capacitor; replace as needed. 	<ul style="list-style-type: none"> Turn power OFF prior to repair. Must clear fault by cycling 24VAC to control. Replace with correct replacement part(s).

TROUBLESHOOTING INFORMATION: UNITARY DIAGNOSTIC CODES

UNITARY DIAGNOSTIC CODES									
Symptoms of Abnormal Operation (Legacy & ComfortBridge™ Thermostat)	Diagnostic/Status LED Display Codes			Fault Description	ComfortBridge™ Thermostat Only		Possible Causes	Corrective Actions	Notes & Cautions
	Digit 3	Digit 2	Digit 1		Message	Code			
<ul style="list-style-type: none"> • Run time for last 4 cycles is less than 3 minutes each. • Compressor protector has not tripped. • Low pressure and high pressure switches are closed. • Integrated control module diagnostic/status LED display shows the indicated code. 	BLANK	0	3	• Short Cycling	CMPR SHRT CYCLE	03	<ul style="list-style-type: none"> • Intermittent thermostat demand. • Faulty compressor relay. 	<ul style="list-style-type: none"> • Check thermostat and thermostat wiring; repair/replace as needed. • Check compressor relay operation; replace control as needed. 	<ul style="list-style-type: none"> • Turn power OFF prior to repair. • Fault will clear after 4 consecutive normal cycles. • Fault may be cleared by cycling 24VAC to control. • Replace with correct replacement part(s). • Minimum compressor run time is changed from 30 seconds to 3 minutes.
<ul style="list-style-type: none"> • Compressor and outdoor fan are off. • Compressor protector trips four consecutive times • Average run time between trips is less than 15 seconds. • Integrated control module diagnostic/status LED display shows the indicated code. • ComfortBridge™ thermostat displays error message. 	BLANK	0	4	• Locked Rotor	LOCKED ROTOR	04	<ul style="list-style-type: none"> • Compressor bearings are seized. • Failed compressor run capacitor. • Faulty run capacitor wiring. • Low line voltage. 	<ul style="list-style-type: none"> • Check compressor operation; repair/replace as needed. • Check run capacitor; replace as needed. • Check wiring; repair/replace as needed. • Verify line voltage is within range on rating plate; contact local utility is out of range. 	<ul style="list-style-type: none"> • Turn power OFF prior to repair. • Must clear fault by cycling 24VAC to control. • Replace with correct replacement part(s).
<ul style="list-style-type: none"> • Compressor and outdoor fan are off for greater than 4 hours. • Low pressure and high pressure switches are closed. • Integrated control module diagnostic/status LED display shows the indicated code. • ComfortBridge™ thermostat displays error message. 	BLANK	0	5	• Open Circuit	OPEN CIRCUIT	05	<ul style="list-style-type: none"> • Power is disconnected. • Failed compressor protector. • Compressor not properly wired to control. 	<ul style="list-style-type: none"> • Check circuit breakers and fuses. • Check wiring to unit; repair/replace as needed. • Check compressor; repair/replace as needed. • Check compressor wiring; repair/replace as needed. 	<ul style="list-style-type: none"> • Turn power OFF prior to repair. • Fault will clear after 1 normal cycle. • Fault may be cleared by cycling 24VAC to control. • Replace with correct replacement part(s).
<ul style="list-style-type: none"> • Compressor and outdoor fan are off. • Low pressure and high pressure switches are closed. • Integrated control module diagnostic/status LED display shows the indicated code. • ComfortBridge™ thermostat displays error message. 	BLANK	0	6	• Open Start Circuit	OPEN START	06	<ul style="list-style-type: none"> • Compressor start winding is open. • Failed compressor run capacitor. • Faulty run capacitor wiring. • Compressor not properly wired to control. • Faulty compressor wiring. 	<ul style="list-style-type: none"> • Check compressor; repair/replace as needed. • Check run capacitor; replace as needed. • Check wiring; repair/replace as needed. 	<ul style="list-style-type: none"> • Turn power OFF prior to repair. • Fault will clear after 1 normal cycle. • Fault may be cleared by cycling 24VAC to control. • Replace with correct replacement part(s).

TROUBLESHOOTING INFORMATION: UNITARY DIAGNOSTIC CODES

UNITARY DIAGNOSTIC CODES									
Symptoms of Abnormal Operation (Legacy & ComfortBridge™ Thermostat)	Diagnostic/Status LED Display Codes			Fault Description	ComfortBridge™ Thermostat Only		Possible Causes	Corrective Actions	Notes & Cautions
	Digit 3	Digit 2	Digit 1		Message	Code			
<ul style="list-style-type: none"> • Compressor and outdoor fan are off. • Low pressure and high pressure switches are closed. • Open start circuit has been detected 4 times with 5 minute delay between each detection. • Integrated control module diagnostic/status LED display shows the indicated code. • ComfortBridge™ thermostat displays error message. 	BLANK	L	6	• Open Start Circuit Lockout	OPEN START LOCK	06	<ul style="list-style-type: none"> • Compressor start winding is open. • Failed compressor run capacitor. • Faulty run capacitor wiring. • Compressor not properly wired to control • Faulty compressor wiring 	<ul style="list-style-type: none"> • Check compressor; repair/replace as needed. • Check run capacitor; replace as needed. • Check wiring repair/replaced as needed. 	<ul style="list-style-type: none"> • Turn power OFF prior to repair • Must clear fault by cycling 24VAC to control • Replace with correct replacement part(s).
<ul style="list-style-type: none"> • Compressor and outdoor fan are off. • Low pressure and high pressure switches are closed. • Integrated control module diagnostic/status LED display shows the indicated code. • ComfortBridge™ thermostat displays error message. 	BLANK	0	7	• Open Run Circuit	OPEN RUN	07	<ul style="list-style-type: none"> • Compressor run winding is open. • Compressor not properly wired to control • Faulty compressor wiring. 	<ul style="list-style-type: none"> • Check compressor; repair/replace as needed. • Check wiring repair/replaced as needed. 	<ul style="list-style-type: none"> • Turn power OFF prior to repair • Fault will clear after 1 normal cycle. • Fault may be cycling 24VAC to control • Replace with correct replacement part(s).
<ul style="list-style-type: none"> • Compressor and outdoor fan are off. • Low pressure and high pressure switches are closed • Open run circuit has been detected 4 times with 5 minute delay between each detection. • Integrated control module diagnostic/status LED display shows the indicated code. • ComfortBridge™ thermostat displays error message. 	BLANK	L	7	• Open Run Circuit Lockout	OPEN RUN LOCK	07	<ul style="list-style-type: none"> • Compressor run winding is open. • Compressor not properly wired to control. • Faulty compressor wiring. 	<ul style="list-style-type: none"> • Check compressor; repair/replace as needed. • Check wiring; repair/replace as needed. 	<ul style="list-style-type: none"> • Turn power OFF prior to repair. • Must clear fault by cycling 24VAC to control • Replace with correct replacement part(s).
<ul style="list-style-type: none"> • Air conditioner/heat pump may appear to be operating normally. • Compressor protector may be open (compressor and outdoor fan off). • Integrated control module diagnostic/status LED display shows the indicated code. 	BLANK	L	8	• Low Line Voltage	LOW LINE VOLT	08	<ul style="list-style-type: none"> • Low line voltage 	<ul style="list-style-type: none"> • Check circuit breakers and fuses • Verify unit is connected to power supply as specified on rating plate • Correct low line voltage condition; contact local utility if needed. 	<ul style="list-style-type: none"> • Turn power OFF prior to repair • Control detects line voltage less than 185 VAC • Fault will clear if line voltage increases above 185 VAC.

TROUBLESHOOTING INFORMATION: UNITARY DIAGNOSTIC CODES

UNITARY DIAGNOSTIC CODES									
Symptoms of Abnormal Operation (Legacy & ComfortBridge™ Thermostat)	Diagnostic/Status LED Display Codes			Fault Description	ComfortBridge™ Thermostat Only		Possible Causes	Corrective Actions	Notes & Cautions
	Digit 3	Digit 2	Digit 1		Message	Code			
<ul style="list-style-type: none"> • Air conditioner/heat pump may appear to be operating normally. • Compressor protector may be open (compressor and outdoor fan off). • Integrated control module diagnostic/status LED display shows the indicated code. 	BLANK	H	8	• High Line Voltage	HIGH LINE VOLT	08	<ul style="list-style-type: none"> • High line voltage 	<ul style="list-style-type: none"> • Correct high line voltage condition; contact local utility if needed. • Verify unit is connected to power supply as specified on rating plate. 	<ul style="list-style-type: none"> • Turn power OFF prior to repair. • Control detects line voltage greater than 255 VAC. • Fault will clear if line voltage decreases below 255 VAC.
<ul style="list-style-type: none"> • Air condition/heat pump may appear to be operating normally. • Integrated control module diagnostic/status LED display shows the indicated code. 	BLANK	0	9	• Low Pilot Voltage	LOW SECOND VOLT	09	<ul style="list-style-type: none"> • Control detects secondary voltage less than 18 VAC. • Transformer overloaded. • Low line voltage 	<ul style="list-style-type: none"> • Check fuse. • Correct low secondary voltage condition • Check transformer; replace if needed. 	<ul style="list-style-type: none"> • Turn power OFF prior to repair. • Fault will clear if secondary voltage rises above 21VAC. • Replace with correct replacement part(s).
<ul style="list-style-type: none"> • Compressor is off. • Integrated control module diagnostic/status LED display shows the indicated code. 	BLANK	P	0	• Comp Protector Open	Not Displayed	Not Displayed	<ul style="list-style-type: none"> • No current through run or start windings. • Compressor run winding is open • Compressor not properly wired to control • Faulty compressor wiring • Failed compressor run capacitor • Faulty run capacitor wiring 	<ul style="list-style-type: none"> • Check compressor; repair/replace as needed • Check wiring; repair/replace as needed • Check run capacitor; replace as needed 	<ul style="list-style-type: none"> • Turn power OFF prior to repair • Fault will clear after 1 normal cycle. • Fault may be cleared by cycling 24VAC to control • Replace with correct replacement part(s).
<ul style="list-style-type: none"> • Air conditioner/heat pump may appear to be operating normally. • Compressor protector may be open (compressor and outdoor fan off). • Integrated control module diagnostic/status LED display shows the indicated code. 	BLANK	0	8	• No Line Voltage	NO LINE VOLTAGE	08	<ul style="list-style-type: none"> • No Line Voltage 	<ul style="list-style-type: none"> • Check circuit breaker and fuses • Verify unit is connected to power supply as specified on rating plate. 	<ul style="list-style-type: none"> • Turn power OFF prior to repair • Control detects line voltage less than 185 VAC. • Fault will clear if line voltage increases above 185 VAC.

WIRING DIAGRAM

WARNING
HIGH VOLTAGE!
 DISCONNECT ALL POWER BEFORE SERVICING OR INSTALLING THIS UNIT. MULTIPLE POWER SOURCES MAY BE PRESENT. FAILURE TO DO SO MAY CAUSE PROPERTY DAMAGE, PERSONAL INJURY OR DEATH.

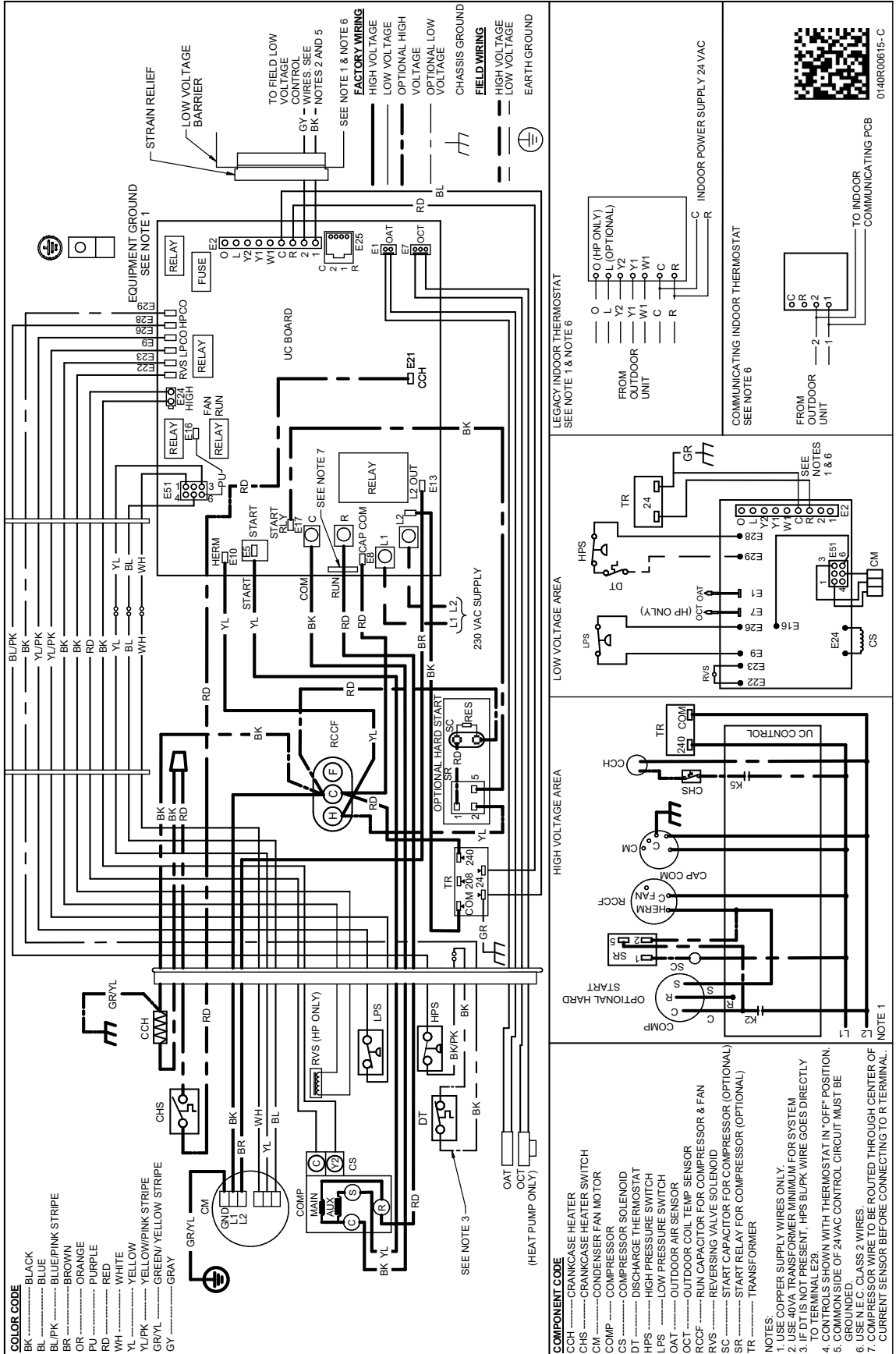

Wiring is subject to change. Always refer to the wiring diagram on the unit for the most up-to-date wiring.

WIRING DIAGRAM

WARNING
 HIGH VOLTAGE!
 DISCONNECT ALL POWER BEFORE SERVICING OR INSTALLING THIS UNIT. MULTIPLE POWER SOURCES MAY BE PRESENT. FAILURE TO DO SO MAY CAUSE PROPERTY DAMAGE, PERSONAL INJURY OR DEATH.

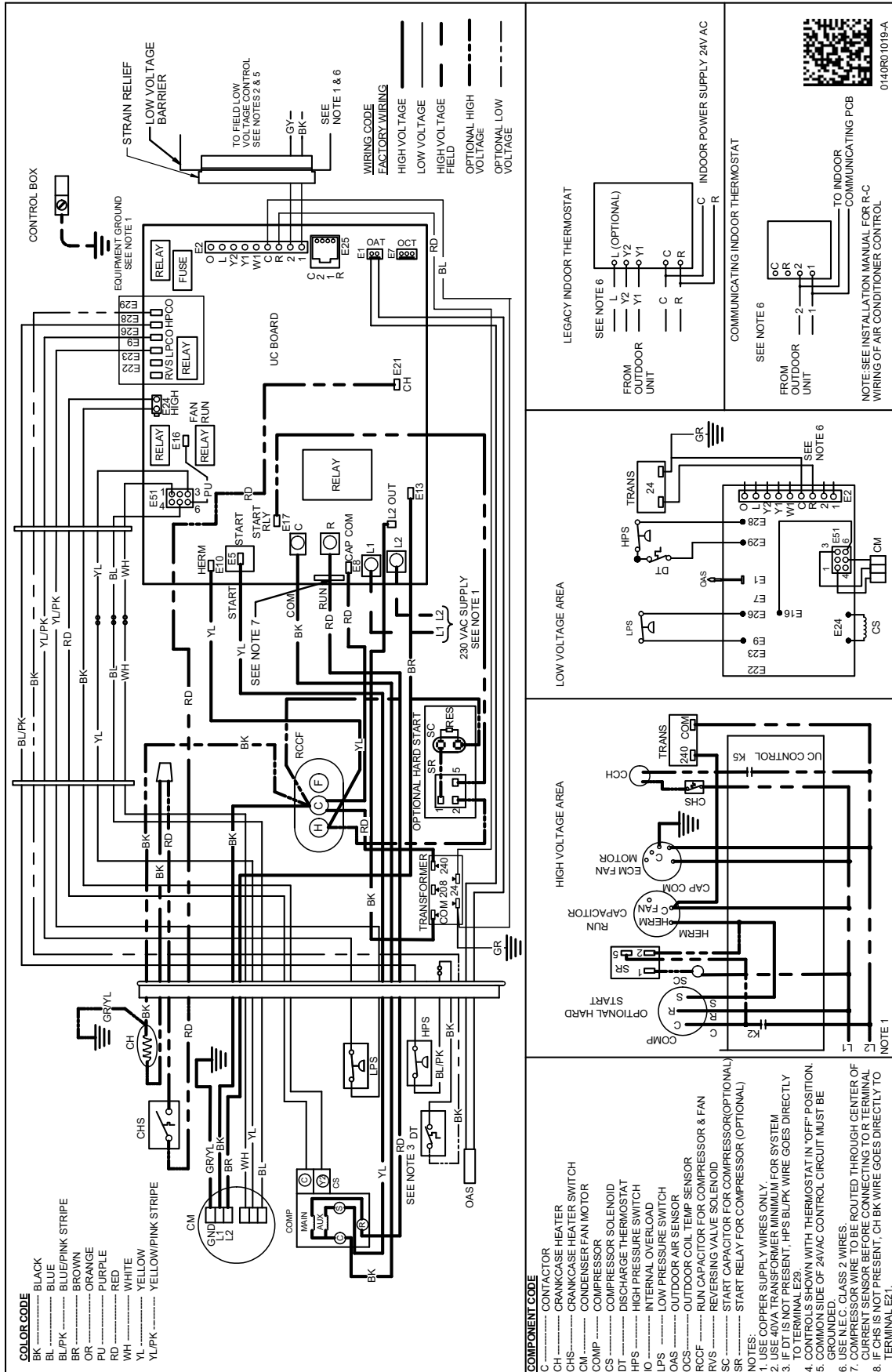

Wiring is subject to change. Always refer to the wiring diagram on the unit for the most up-to-date wiring.

SPLIT SYSTEMS

AIR CONDITIONING AND HEAT PUMP HOMEOWNER'S ROUTINE MAINTENANCE RECOMMENDATIONS

We strongly recommend a bi-annual maintenance checkup be performed before the heating and cooling seasons begin by a **qualified servicer**.

Replace or Clean Filter

IMPORTANT NOTE: Never operate unit without a filter installed as dust and lint will build up on internal parts resulting in loss of efficiency, equipment damage and possible fire.

An indoor air filter must be used with your comfort system. A properly maintained filter will keep the indoor coil of your comfort system clean. A dirty coil could cause poor operation and/or severe equipment damage.

Your air filter or filters could be located in your furnace, in a blower unit, or in "filter grilles" in your ceiling or walls. The installer of your air conditioner or heat pump can tell you where your filter(s) are, and how to clean or replace them.

Check your filter(s) at least once a month. When they are dirty, replace or clean as required. Disposable type filters should be replaced. Reusable type filters may be cleaned.

You may want to ask your dealer about high efficiency filters. High efficiency filters are available in both electronic and non-electronic types. These filters can do a better job of catching small airborne particles.

Compressor

The compressor motor is hermetically sealed and does not require additional oiling.

Motors

Indoor and outdoor fan motors are permanently lubricated and do not require additional oiling.

Clean Outside Coil (Qualified Servicer Only)



WARNING

HIGH VOLTAGE!

DISCONNECT ALL POWER BEFORE SERVICING.
MULTIPLE POWER SOURCES MAY BE PRESENT.
FAILURE TO DO SO MAY CAUSE PROPERTY DAMAGE,
PERSONAL INJURY OR DEATH.



Air must be able to flow through the outdoor unit of your comfort system. Do not construct a fence near the unit or build a deck or patio over the unit without first discussing your plans with your dealer or other qualified servicer. Restricted airflow could lead to poor operation and/or severe equipment damage.

Likewise, it is important to keep the outdoor coil clean. Dirt, leaves, or debris could also restrict the airflow. If cleaning of the outdoor coil becomes necessary, hire a qualified servicer. Inexperienced people could easily puncture the tubing in the coil. Even a small hole in the tubing could eventually cause a large loss of refrigerant. Loss of refrigerant can cause poor operation and/or severe equipment damage.

Do not use a condensing unit cover to "protect" the outdoor unit during the winter, unless you first discuss it with your dealer. Any cover used must include "breathable" fabric to avoid moisture buildup.

BEFORE CALLING YOUR SERVICER

- Check the thermostat to confirm that it is properly set.
- Wait 15 minutes. Some devices in the outdoor unit or in programmable thermostats will prevent compressor operation for awhile, and then reset automatically. Also, some power companies will install devices which shut off air conditioners for several minutes on hot days. If you wait several minutes, the unit may begin operation on its own.
- Check the electrical panel for tripped circuit breakers or failed fuses. Reset the circuit breakers or replace fuses as necessary.
- Check the disconnect switch near the indoor furnace or blower to confirm that it is closed.
- Check for obstructions on the outdoor unit. Confirm that it has not been covered on the sides or the top. Remove any obstruction that can be safely removed. If the unit is covered with dirt or debris, call a qualified servicer to clean it.
- Check for blockage of the indoor air inlets and outlets. Confirm that they are open and have not been blocked by objects (rugs, curtains or furniture).
- Check the filter. If it is dirty, clean or replace it.
- Listen for any unusual noise(s), other than normal operating noise, that might be coming from the outdoor unit. If you hear unusual noise(s) coming from the unit, call a qualified servicer.



CAUTION

TO AVOID THE RISK OF EQUIPMENT DAMAGE OR FIRE, INSTALL THE SAME AMPERAGE BREAKER OR FUSE AS YOU ARE REPLACING. IF THE CIRCUIT BREAKER OR FUSE SHOULD OPEN AGAIN WITHIN THIRTY DAYS, CONTACT A QUALIFIED SERVICER TO CORRECT THE PROBLEM.

IF YOU REPEATEDLY RESET THE BREAKER OR REPLACE THE FUSE WITHOUT HAVING THE PROBLEM CORRECTED, YOU RUN THE RISK OF SEVERE EQUIPMENT DAMAGE.

START-UP CHECKLIST

Condenser / Heat Pump (including all Inverter)	
	Model Number _____ Serial Number _____
ELECTRICAL (Outdoor Unit)	
Line Voltage (Measure L1 and L2 Voltage)	L1 - L2 _____
Secondary Voltage (Measure Transformer Output Voltage) NOT ALL MODELS	R - C _____
Compressor Amps	_____
Condenser Fan Amps	_____
TEMPERATURES (Indoor Unit)	
Return Air Temperature (Dry bulb / Wet bulb)	_____ DB °F _____ WB °F
Cooling Supply Air Temperature (Dry bulb / Wet bulb)	_____ DB °F _____ WB °F
Delta T (Difference between Supply and Return Temperatures)	_____ DB °F
PRESSURES / TEMPERATURES (Outdoor Unit)	
Suction Circuit (Pressure / Suction Line Temperature)	PSIG _____ TEMP _____ °F
Liquid Circuit (Pressure / Liquid Temperature)	PSIG _____ TEMP _____ °F
Outdoor Air Temperature (Dry bulb / Wet bulb)	_____ DB °F _____ WB °F
SUPERHEAT / SUBCOOLING	
Line set length in Feet	SH _____ SC _____
Additional Refrigerant Charge Added over Factory Charge (Ounces)	_____
Additional Checks	
Check wire routings for any rubbing	_____
Check factory wiring and wire connections.	_____
Check product for proper clearances as noted by installation instructions	_____
°F to °C formula: $(^{\circ}\text{F} - 32) \text{ divided by } 1.8 = ^{\circ}\text{C}$ °C to °F formula: $(^{\circ}\text{C} \text{ multiplied by } 1.8) + 32 = ^{\circ}\text{F}$	

THIS PAGE INTENTIONALLY LEFT BLANK

THIS PAGE INTENTIONALLY LEFT BLANK

CUSTOMER FEEDBACK

We are very interested in all product comments.

Please fill out the feedback form on one of the following links:

Daikin Products: (<https://daikincomfort.com/contact-us>)

Goodman® Brand Products: (<http://www.goodmanmfg.com/about/contact-us>).

Amana® Brand Products: (<http://www.amana-hac.com/about-us/contact-us>).

You can also scan the QR code on the right for the product brand you purchased to be directed to the feedback page.



DAIKIN



GOODMAN® BRAND



AMANA® BRAND

PRODUCT REGISTRATION

Thank you for your recent purchase. Though not required to get the protection of the standard warranty, registering your product is a relatively short process, and entitles you to additional warranty protection, except that failure by California and Quebec residents to register their product does not diminish their warranty rights. The duration of warranty coverages in Texas and Florida differs in some cases.

For Product Registration, please register as follows:

Daikin Products: (<https://daikincomfort.com/owner-support/product-registration>).

Goodman® Brand products: (<https://www.goodmanmfg.com/product-registration>).

Amana® Brand products: (<http://www.amana-hac.com/product-registration>).

You can also scan the QR code on the right for the product brand you purchased to be directed to the Product Registration page.



DAIKIN



GOODMAN® BRAND



AMANA® BRAND

19001 Kermier Rd., Waller, TX 77484

www.goodmanmfg.com • www.amana-hac.com

© 2014, 2016-2024 Daikin Comfort Technologies Manufacturing, L.P.

Amana is a registered trademark of Maytag Corporation or its related companies and is used under license.

All rights reserved.