

### Features

- Single-function rainhead
- Full Coverage with Katalyst technology delivers a drenching spray experience, ideal for rinsing shampoo from hair
- Optimized 8" sprayface with 80 nozzles creates a dense uniform spray pattern for consistent coverage and feeling of warmth
- MasterClean™ sprayface features an easy-to-clean surface that withstands mineral buildup
- Part of the Occasion bathroom faucet and accessory collection

### Material

- Premium material construction for durability and reliability
- KOHLER finishes resist corrosion and tarnishing

### Technology

- Katalyst™ air-induction technology infuses water with air, creating bigger drops for a more powerful spray

### Installation

- 1/2 -14 NPT connection
- Requires rainhead arm and flange (sold separately)
- Wall- or ceiling-mount



### Codes/Standards







ASME A112.18.1/CSA B125.1  
DOE - Energy Policy Act 1992

### KOHLER® Faucet Lifetime Limited Warranty

See website for detailed warranty information.

### Available Colors/Finishes

*Color tiles intended for reference only.*

Color	Code	Description
	CP	Polished Chrome
	BN	Vibrant™ Brushed Nickel
	BV	Vibrant™ Brushed Bronze
	BL	Matte Black
	2MB	Vibrant™ Brushed Moderne Brass
	TT	Vibrant Titanium

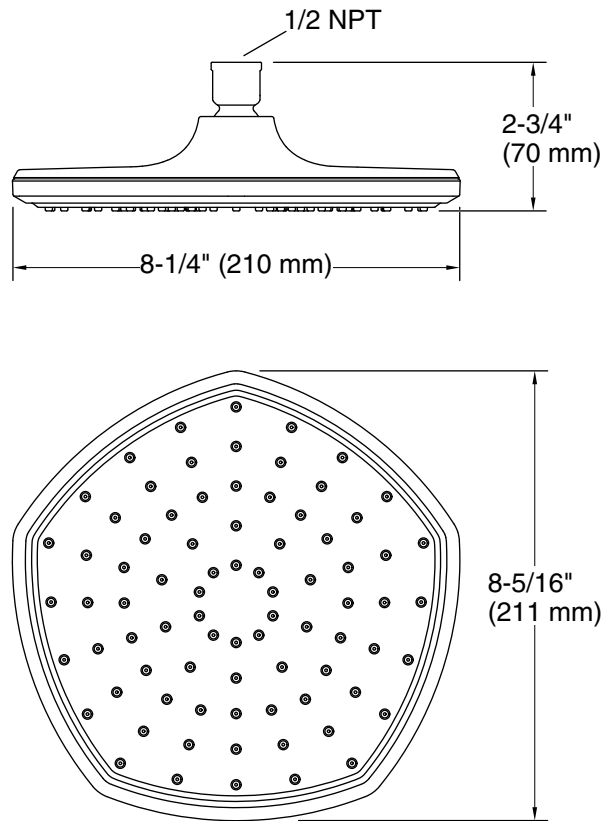

### Technical Information

All product dimensions are nominal.

#### Showerhead/Body Spray:

Rated maximum flow: 2.5 gal/min (9.5 l/min)

flow:

Pressure: 80 psi (5.5 bar)

### Notes

For use with automatic compensating valves rated at 2.5 gal/min (9.5 l/min) or less.

Install this product according to the installation instructions.